

DEVELOPMENT AND CAPABILITIES OF ISS FLOW BOILING AND CONDENSATION EXPERIMENT

Henry Nahra¹, Mohammad Hasan¹, R. Balasubramaniam¹, Michelle Patania¹, Nancy Hall¹, James Wagner¹, Jeff Mackey², Bruce Frankenfield¹, Daniel Hauser¹, George Harpster¹, David Nawrocki¹, Randy Clapper¹, John Kolacz¹, Robert Butcher¹, Rochelle May¹, David Chao¹, Issam Mudawar³, Chirag R. Kharagante³, Lucas E. O'Neill³

¹NASA Glenn Research Center, 21000 Brookpark Rd., Cleveland, OH 44135

²Vantage Partners LLC, 3000 Aerospace Parkway, Brookpark 44142

³ Purdue University Boiling and Two-Phase Flow Laboratory (PU-BTFPL), 585 Purdue Mall, West Lafayette, IN47907, U.S.A

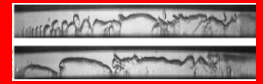

Agenda

- ❑ Experiment Objective
- ❑ Top Level Science Requirements and Constraints
 - ISS Constraints
 - Mass, Volume, Power, Cooling Constraints
- ❑ Test Sections
- ❑ Fluid System
 - Engineering Schematic
 - Fluid System nPFH Module
 - Fluid System Cooling Module
 - Fluid System Preheater
- ❑ Breadboard Testing
 - Pressure data and Inlet conditions for Condensation Experiment
 - Pressure data and Inlet conditions for Flow Boiling Experiment
 - Video Imaging and Capabilities
- ❑ Future Work

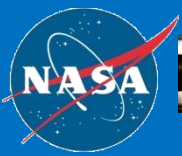

Flow Boiling and Condensation Experiment

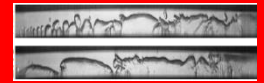

FBCE Science Objectives

The proposed research aims to develop an **integrated two-phase flow boiling/condensation facility for the International Space Station (ISS)** to serve as primary platform for obtaining two-phase flow and heat transfer data in microgravity.

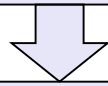

Key objectives are:

1. Obtain **flow boiling database** in long-duration microgravity environment
2. Obtain **flow condensation database** in long-duration microgravity environment
3. Develop experimentally validated, **mechanistic model** for microgravity flow boiling **critical heat flux (CHF)** and **dimensionless criteria** to predict **minimum flow velocity** required to ensure **gravity-independent CHF**
4. Develop experimentally validated, **mechanistic model** for microgravity annular condensation and **dimensionless criteria** to predict **minimum flow velocity** required to ensure **gravity-independent annular condensation**; also develop correlations for other condensation regimes in microgravity

Applications include:

1. Rankine Cycle Power Conversion System for Space
2. Two Phase Flow Thermal Control Systems and Advanced Life Support Systems
3. Gravity Insensitive Vapor Compression Heat Pump for Future Space Vehicles and Planetary Bases
4. Cryogenic Liquid Storage and Transfer

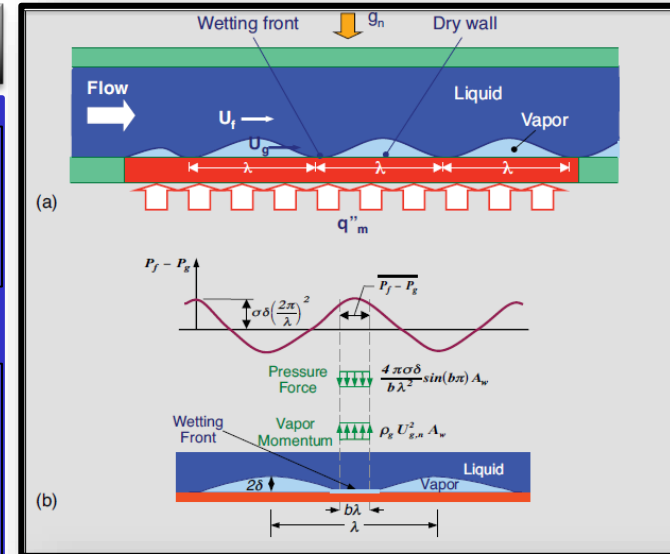

Interfacial Lift-off Model: (a) schematic representation of wavy vapor layer. (b) Balance of vapor momentum and interfacial pressure difference at moment of wetting front separation.

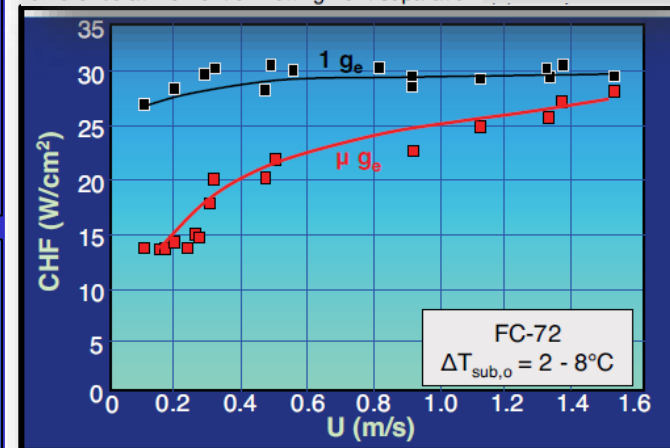

- Science Requirements Document for FBCE, March, 2013
- Science Concept Review Presentation, December 2011



Flow Boiling and Condensation Experiment

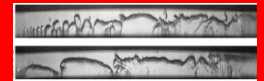

Flow Boiling and Condensation Fluid Systems

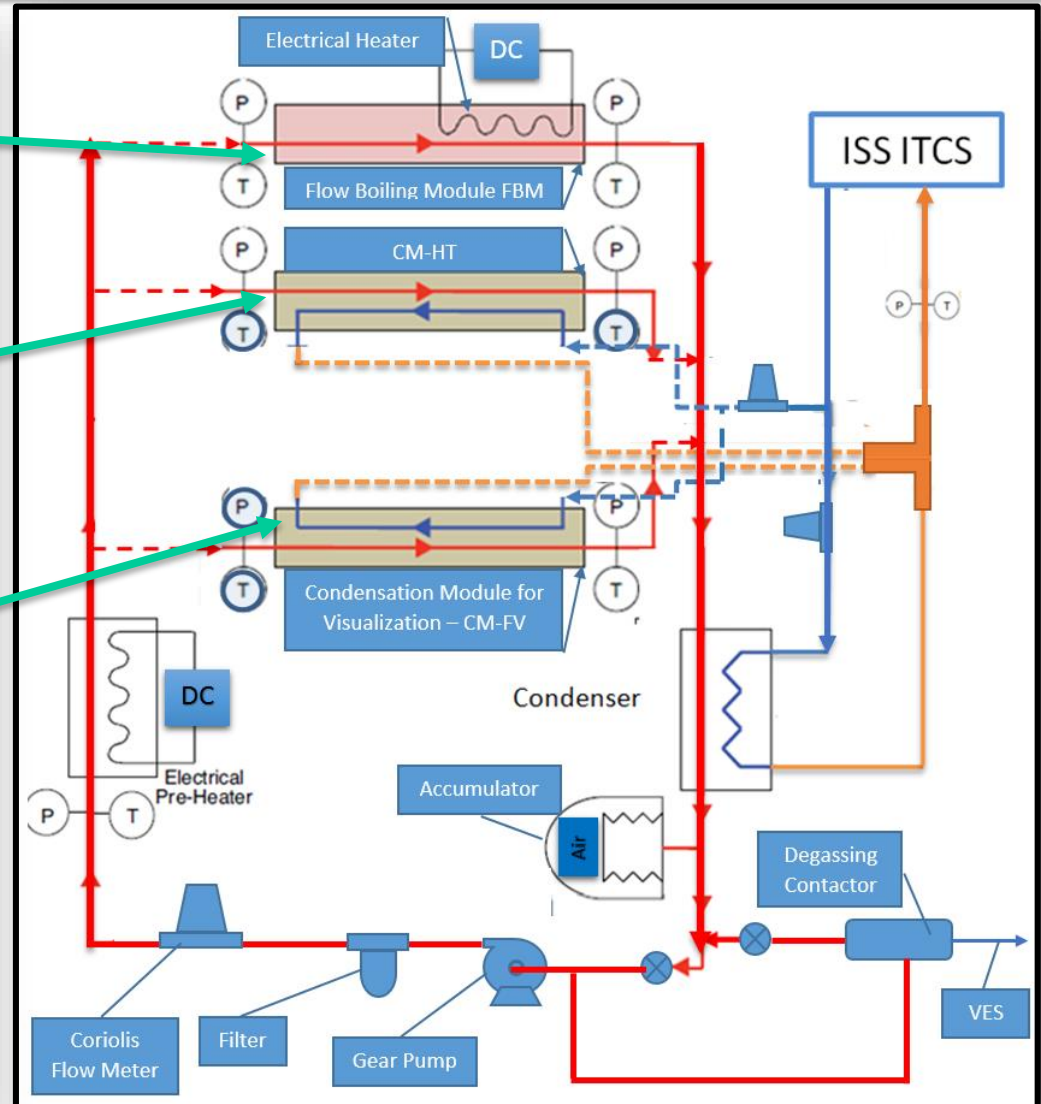
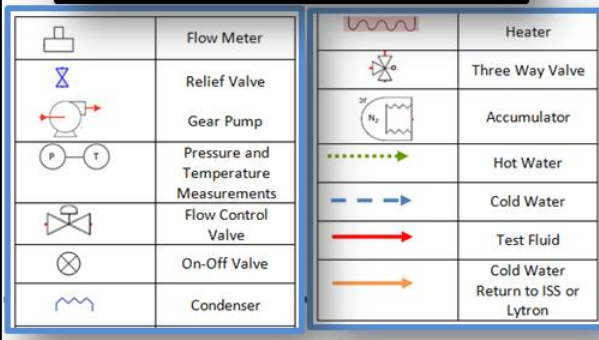
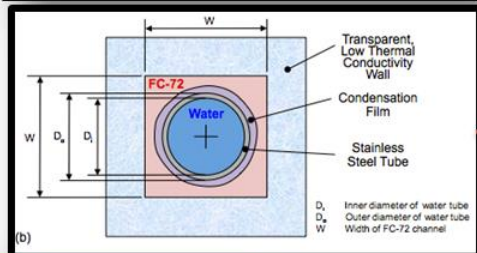
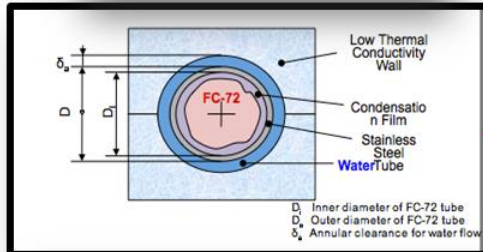
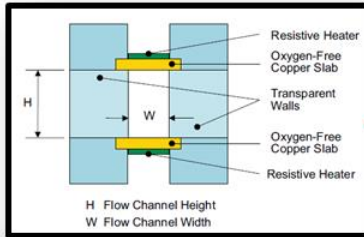

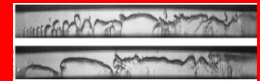

Top Level Science Requirements and Constraints

❑ Requirements-Fluid System

- Deliver flow rates between 2 and 14 g/s of nPFH for Condensation Experiments and 2 to 40 g/s for Flow Boiling Experiments
- Deliver the required power up to 1660 W to the fluid
- Deliver the required system pressure of 100 and 150 kPa
- Volume increase is accommodated with an accumulator
- Deliver the required thermodynamic conditions of the fluid at the entrance of the test modules (subcooled, saturated and two-phase mixture)
- Provide the fluid cooling function

❑ Constraints

- Limitation on the available power (~1660 W total available for heating) and available heat dissipation (~1600 W)
- ITCS cooling water flow rate up ~50 g/s to and returning stream temperature requirement of 40-49 °C
- Volume constraint 91.44x121.92x48.28 cm³ (36x48x19 in³)
- Mass constraint (~200 kg max)

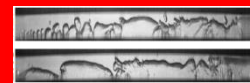

Flow Boiling and Condensation Test Modules

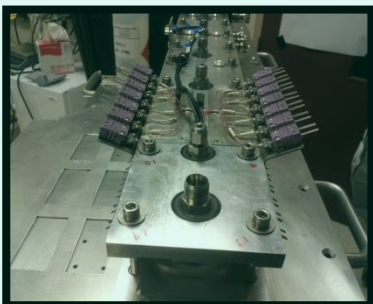

Flow Boiling Module Assembled

Flow Boiling Module

- Subcooled, saturated and 2-phase Inlet condition at:
 - Mass Flow Rate 2.5 to 40 g/s
 - Heat Flux <math>< 60 \text{ W/cm}^2</math>

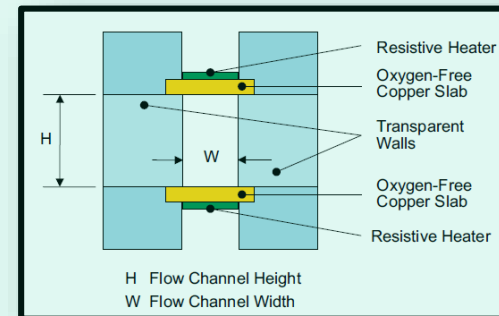

CM-FV Test Module

Condensation Module –Flow Visualization

- Saturated vapor Inlet condition
 - Mass Flow Rate 2 to 14 g/s

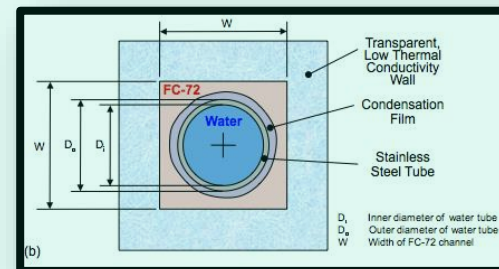

CM-HT Test Module

Condensation Module –Heat Transfer

- Saturated vapor Inlet condition
 - Mass Flow Rate 2 to 14 g/s

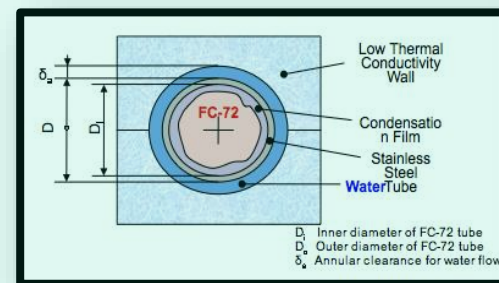

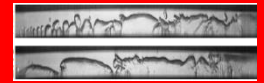

FBCE Fluid System (FS) Modules

Fluid System (FS) nPFH Module

- Consists of:
 - Pump
 - Filter
 - Coriolis flow meter
 - Degassing

FS Cooling Module

- Consists of:
 - Condenser
 - Accumulator
 - Coriolis flow meters

FS Preheater Module

- Consists of:
 - Preheater
 - Electronics and Control

FS nPFH Module

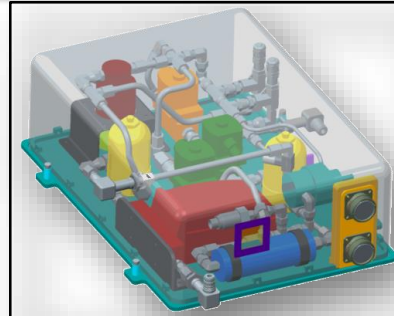

FS Cooling Module

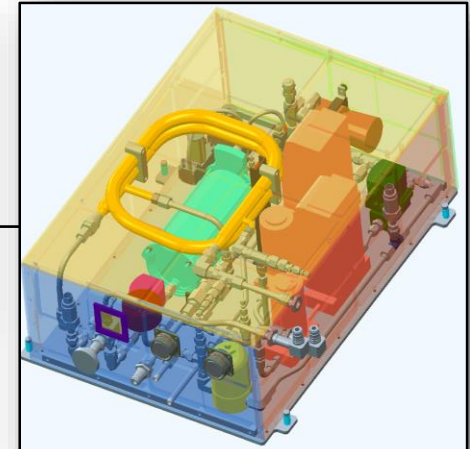

FS Bulk Heater Module

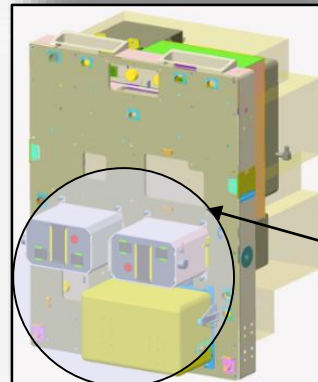
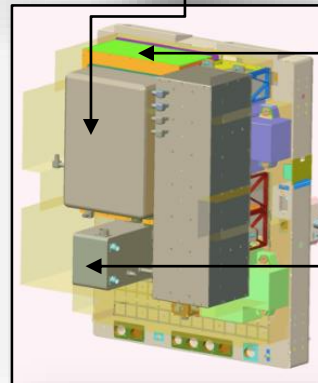
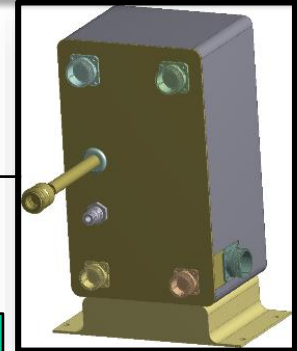

Front of FIR

Back of FIR
2 RHDMs
and BCAPIS



Breadboard/Brassboard Model

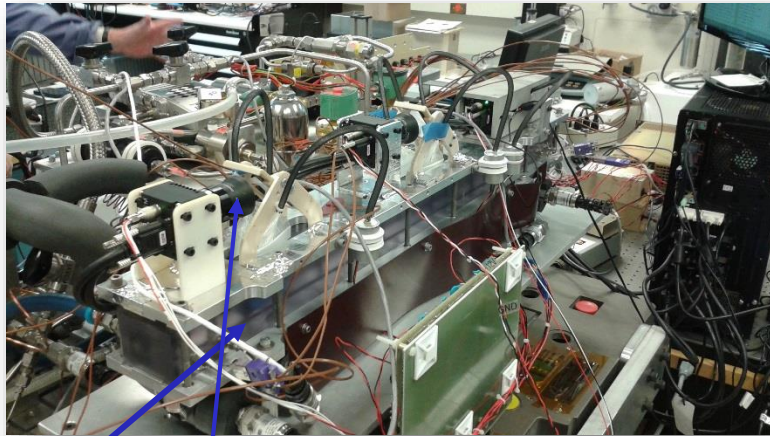
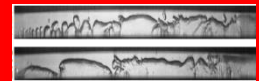

CM-FV

High Speed Cameras

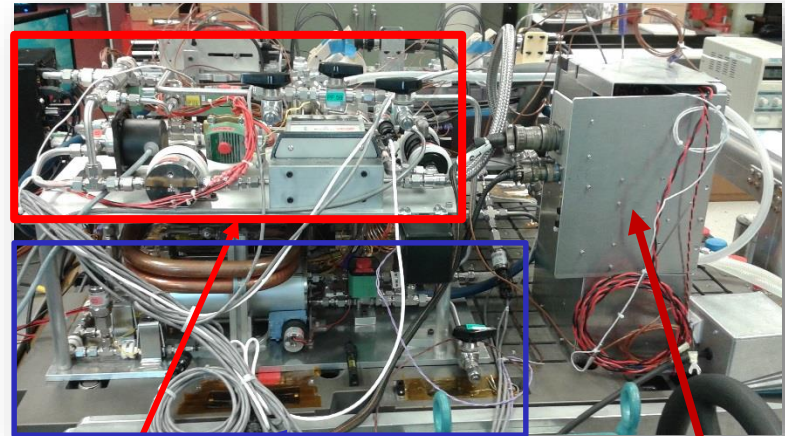

nPFH Module

Cooling Module

Bulk Heater Module

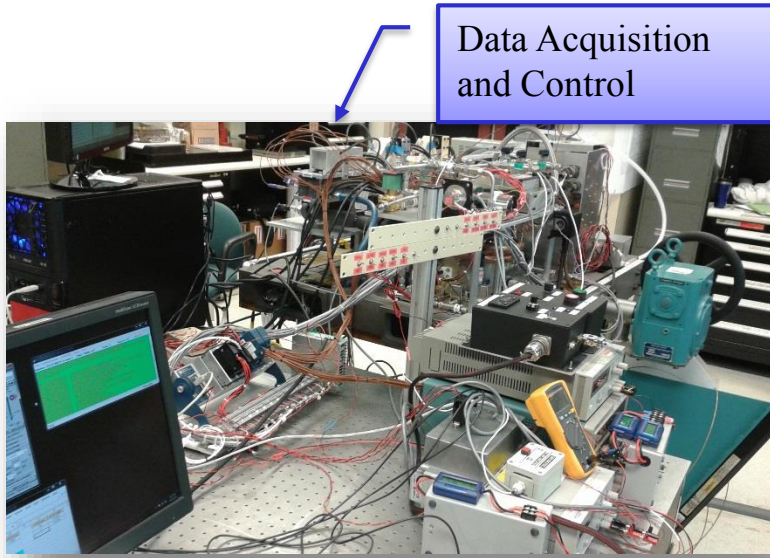

Data Acquisition and Control

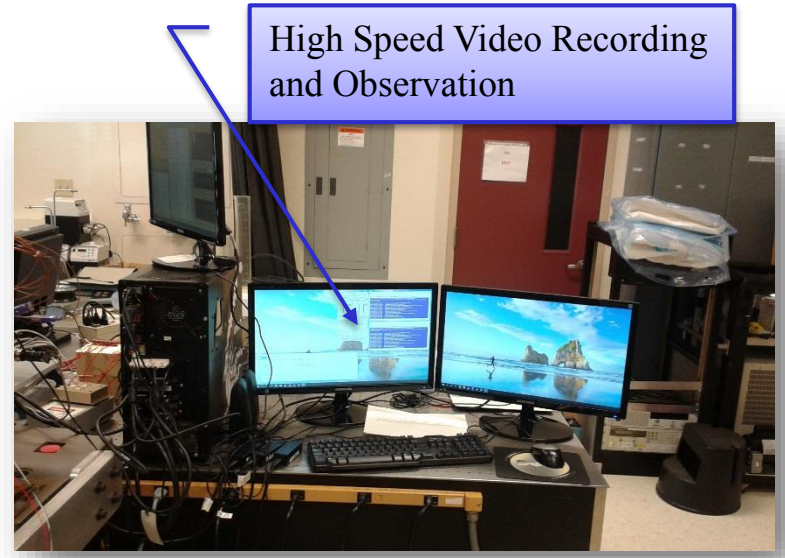

High Speed Video Recording and Observation



Flow Boiling and Condensation Experiment

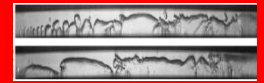

Experiments...Heater Performance Study

Similar Conditions used for Split and Solid Sheath:

- ❑ Low Flow Test (2 g/s) , 100 kPa
 - Average FC-72 into Bulk Heater:
 - 1.98 ± 0.11 g/s, 23.6 ± 0.9 C
 - Average Water into Condenser:
 - 20 ± 0.1 g/s, 20.4 ± 0.1 C
 - Average Water into CM-FV:
 - 5.07 ± 0.01 g/s, 21.2 ± 0.2 C
- ❑ High Flow Test (40 g/s) , 100 kPa
 - Average FC-72 into Bulk Heater:
 - 40 ± 0.2 g/s, 32.76 ± 0.2 C
 - Average Water into Condenser:
 - $15.04 (\pm 0.02)$ g/s, $20.4 (\pm 0.1)$ C
 - Average Water into CM-FV:
 - $15.1 (\pm 0.1)$ g/s, $20.4 (\pm 0.1)$ C

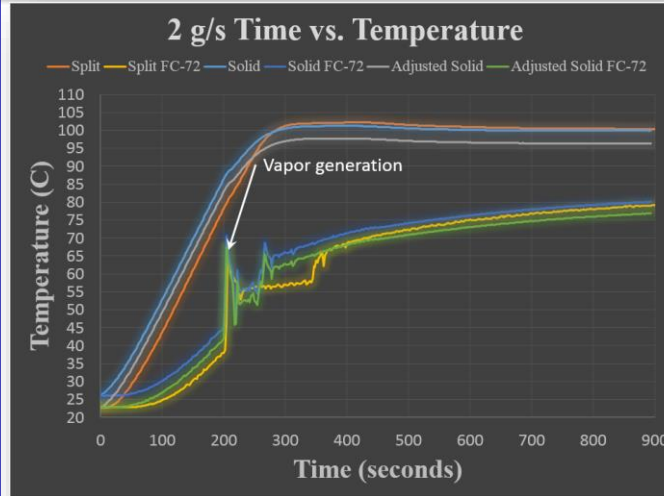

Bulk heater testing info:

- 3 main equally spaced heating element locations, Split
- 3 main equally spaced heating element locations, Solid
- 3 booster heating element locations, NOT USED
- 3 booster heating element locations, NOT USED
- 2 Thermowell locations, alternates used in testing
- 4 Thermostat locations

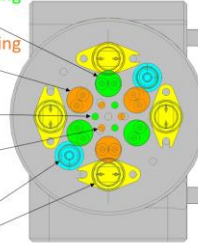

Solid sheath heating elements seem to heat quicker

- Cartridge heaters pressed into the aluminum holes (typical installation) should provide even quicker heating
- Pressed in cartridge heaters are less likely to fall out

The solid sheath cartridge heaters were run at a lower voltage than the split sheath cartridge heaters

- Electrical tests indicated that the solid sheath had lower electrical resistance than the split sheath cartridge heaters
- Even with less voltage, the solid sheath heated quicker

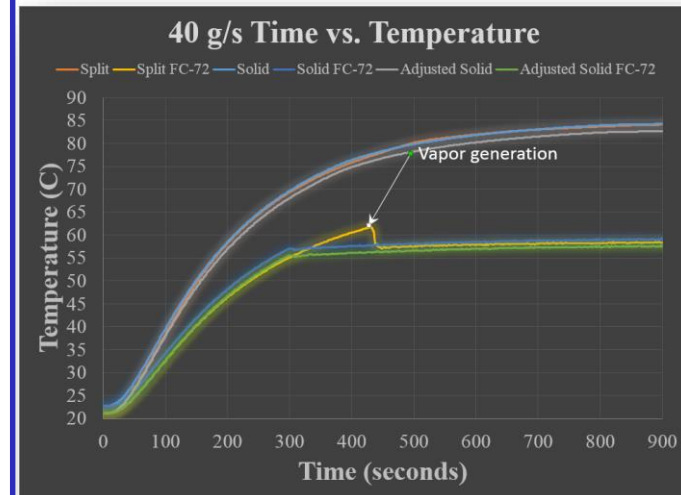

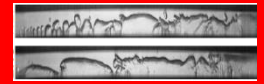
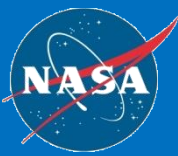

Experiments...Heater Performance Study

- ❑ Solid sheath cartridge heaters
 - Faster heating, better fit and lower contact resistance, operates at lower voltage
 - Bulk heater manufacturer makes solid sheath cartridge heaters
 - Could have the manufacturer build this as COTS
- ❑ Split sheath cartridge heaters
 - Typically used for ease of removal to facilitate replacement
 - FBCE does not require this feature
 - Allows a TC in the hole with the cartridge heaters
 - Bulk heater manufacturer does not make solid sheath cartridge heaters
 - GRC assembly of cartridge heaters into bulk heater



Flow Boiling and Condensation Experiment

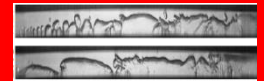

Experiments...Fluid system Performance Assessment

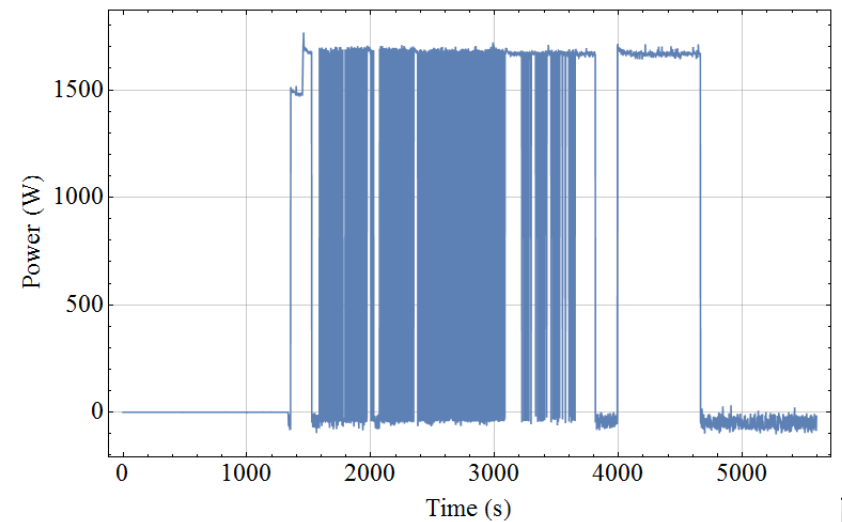
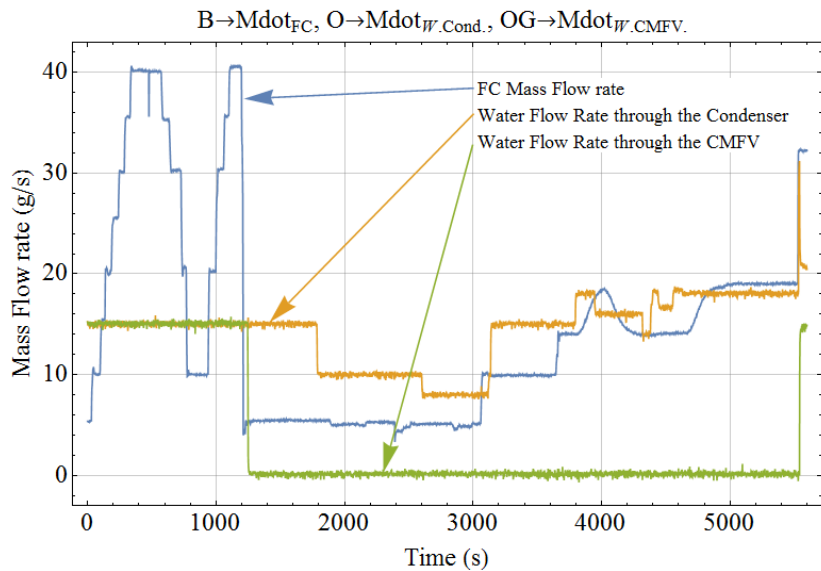
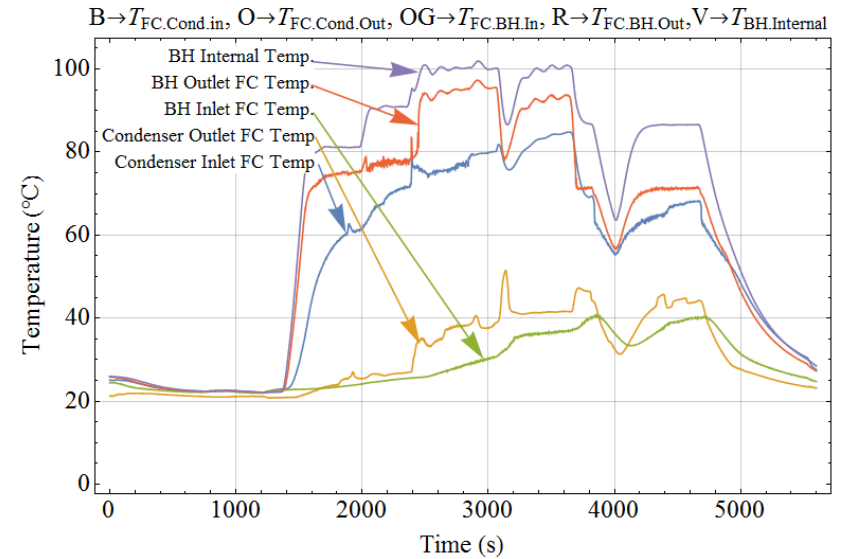
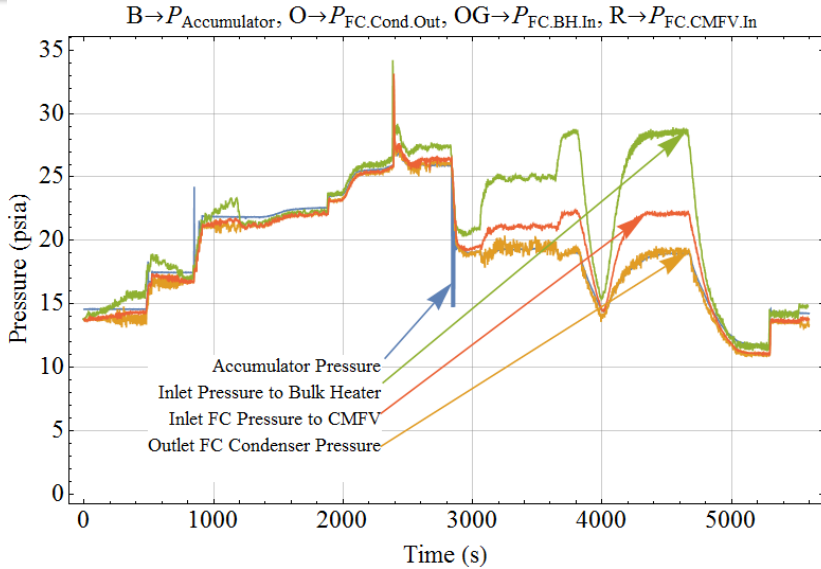

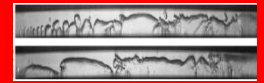

Experiments...Fluid system Performance Assessment

- ❑ System pressure increases steadily with flow rates
- ❑ Heater power averaged over periods of time where FC-72 flow rate is constant
- ❑ Heat gained by FC-72 in bulk heater was calculated from thermodynamic measurements
- ❑ An average of 54 W lost from heater at 14 g/s of FC and slightly lower heat loss of 45 W at 10 g/s
- ❑ Similar analysis on CMFV showed a loss of 65 W to ambient

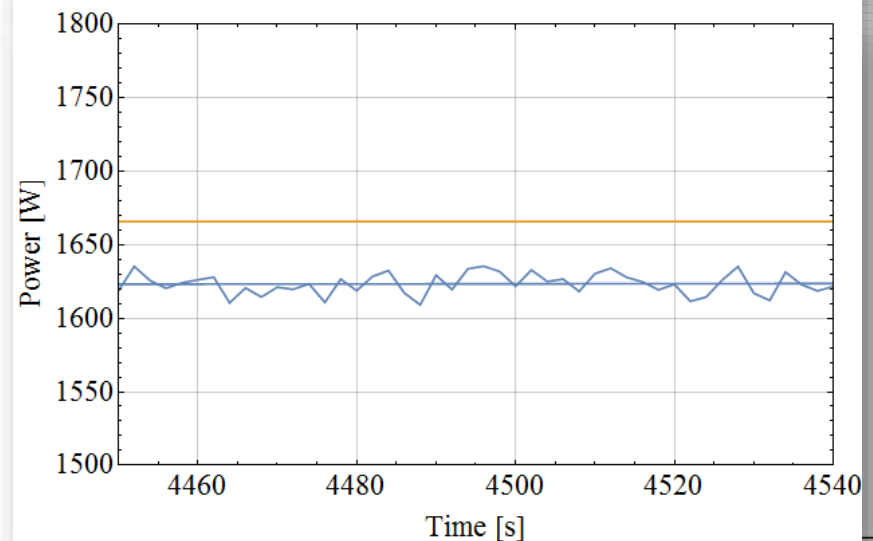
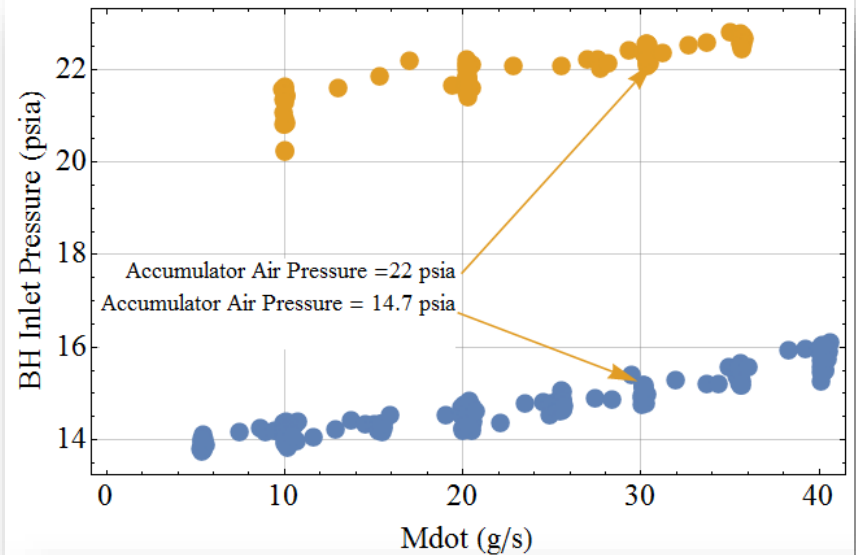

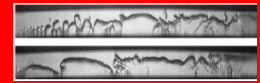

Experiments... Transients in Flow Condensation

- ❑ Flow loop along with selected test modules is capable of obtaining full transient to steady state data along with high speed imaging
- ❑ Example of Transient Test Run with CM-FV
 - FC-72 vapor with specified inlet conditions (flow rate and temperature) introduced into the condensation module with no cooling water flow and allowed sufficient time for steady state
 - Cooling water flow rate started simultaneously with high speed video recording
 - High speed video recorded at 1000 fps for 29 seconds to capture the condensation transient
 - Relevant data (water and surface temperature, FC-72 and water flow rates, pressure) continuously recorded at 1 Hz
 - At the end of 10 minutes time interval, two seconds of high speed video is recorded to provide a comparison between the steady state and the transient

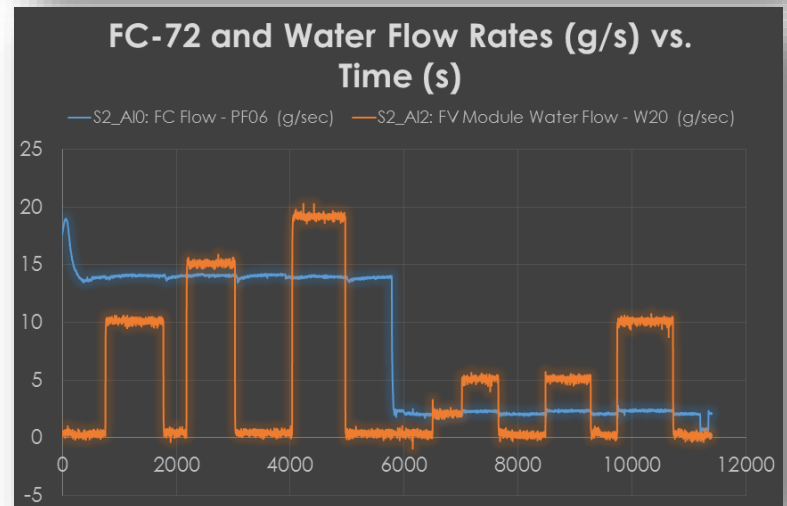
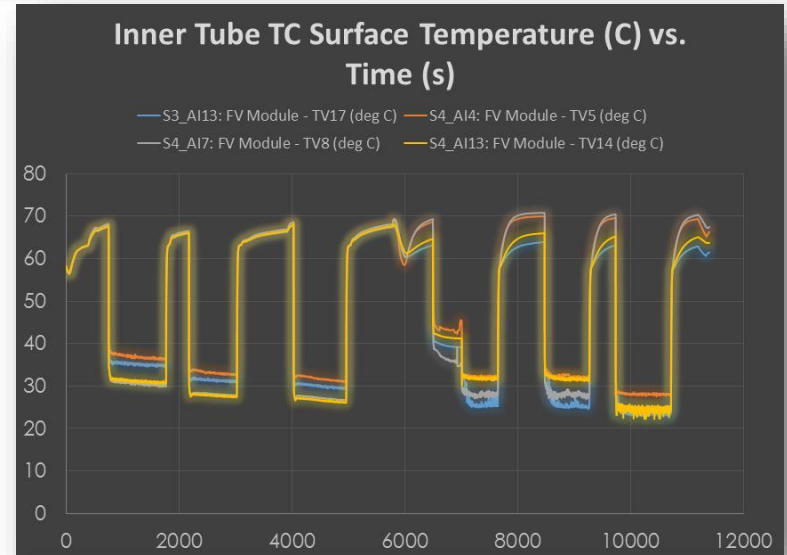



Flow Boiling and Condensation Experiment

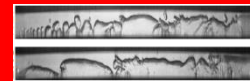

Experiments... Transients in Flow Condensation

- ❑ Transient of 10 seconds observed upon turning on water flow rate
- ❑ A time scale of about 25 second observed upon turning off cooling water to CMFV

Inner Tube TC Surface Temperature (C) vs. Time (s)

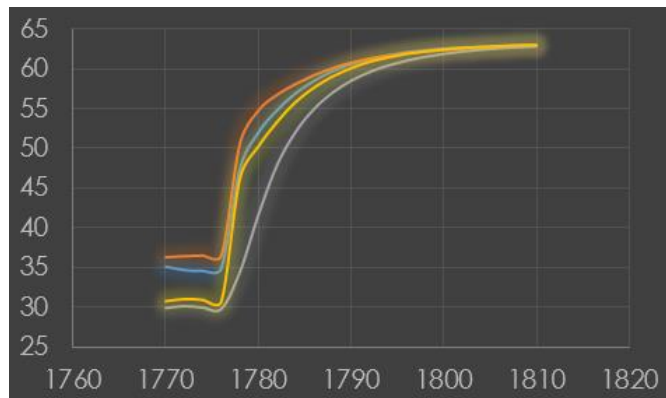
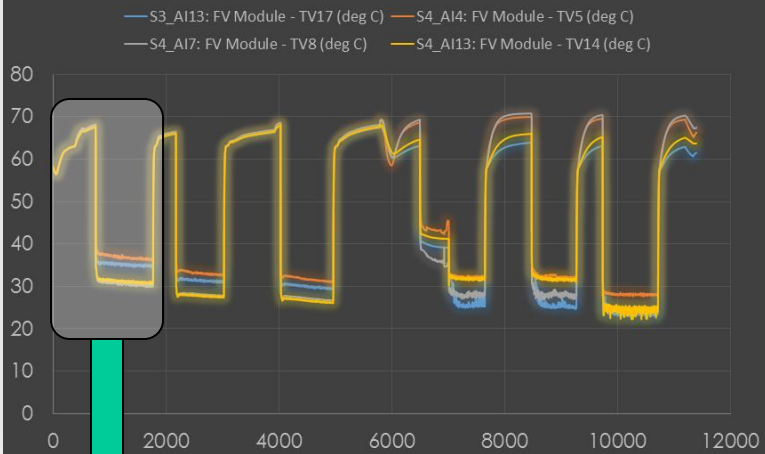

Glenn Research Center

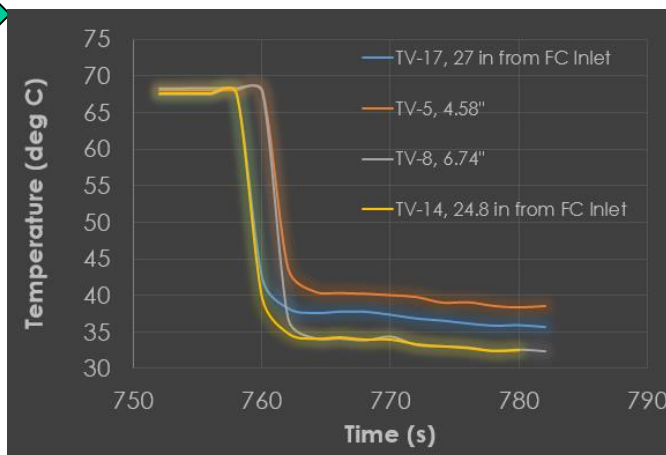
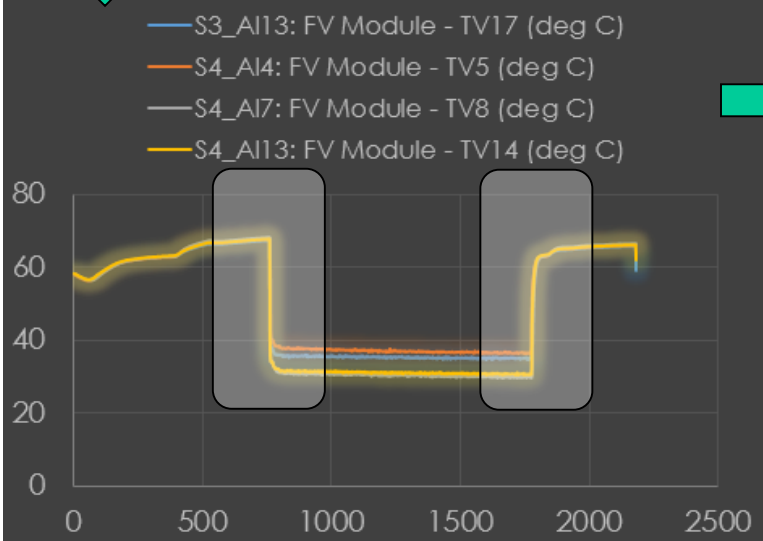

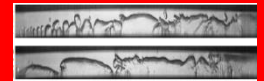

Experiments... Transients in Flow Condensation

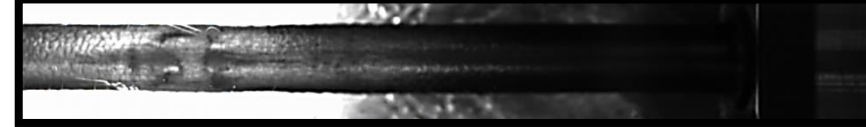
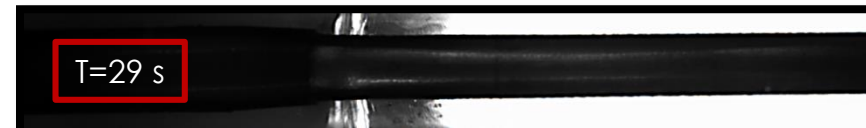
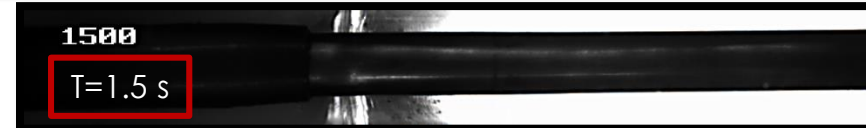
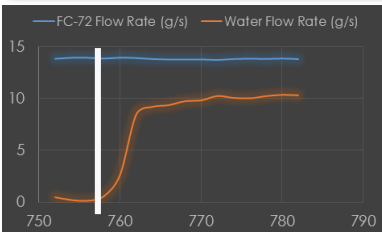
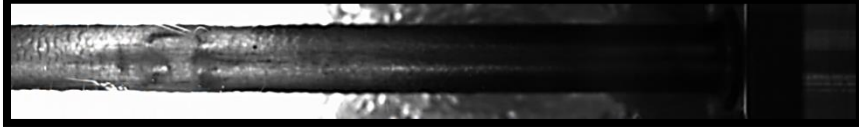
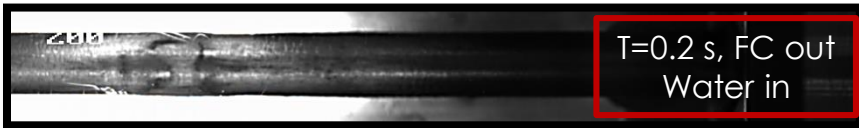
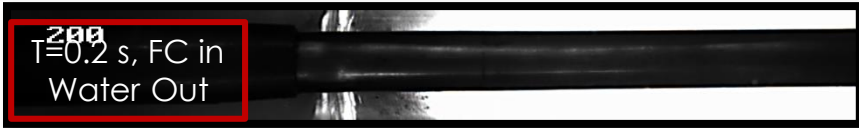

- ❑ High speed imaging (1000 fps) of condensation in CM-FV in the horizontal configuration for 0.2 s, 1.5 s, 10 s and 29 s.
- ❑ Imaging started simultaneously with water flow rate as designated by the white vertical line in the graph on the left

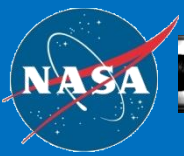

Flow Boiling and Condensation Experiment

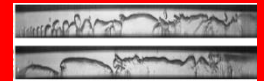

Experiments... Transients in Flow Condensation

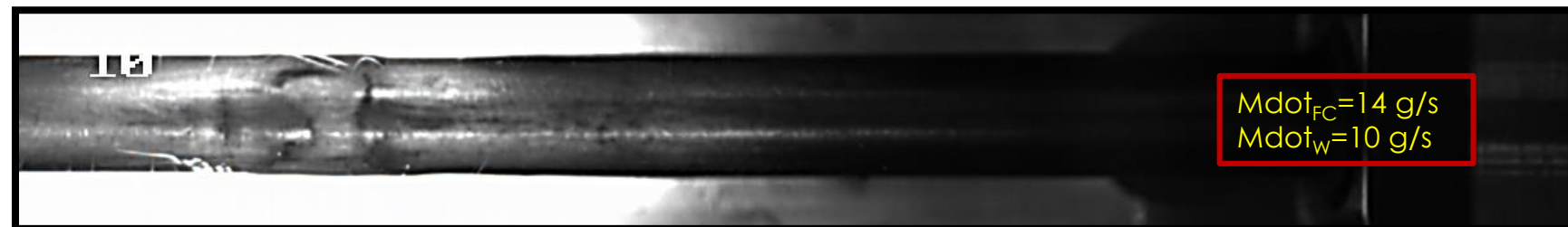
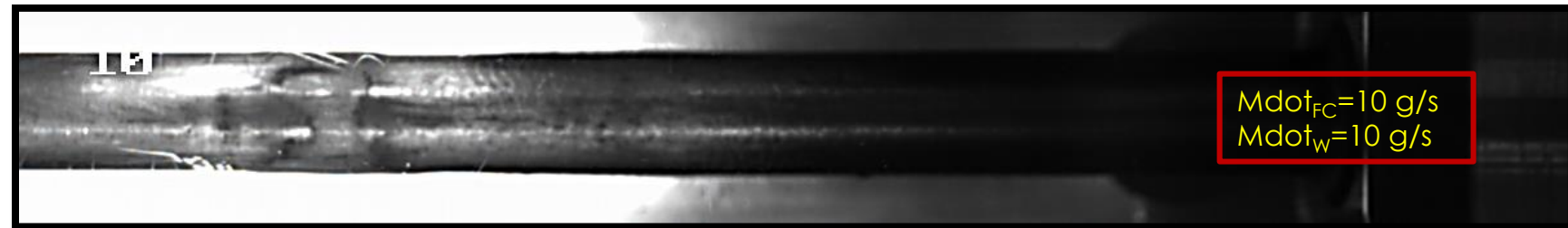

Flow condensation with increasing FC-72 flow rate and constant water flow rate



Flow Boiling and Condensation Experiment

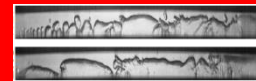

Summary

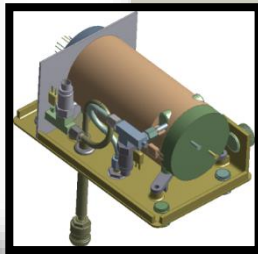
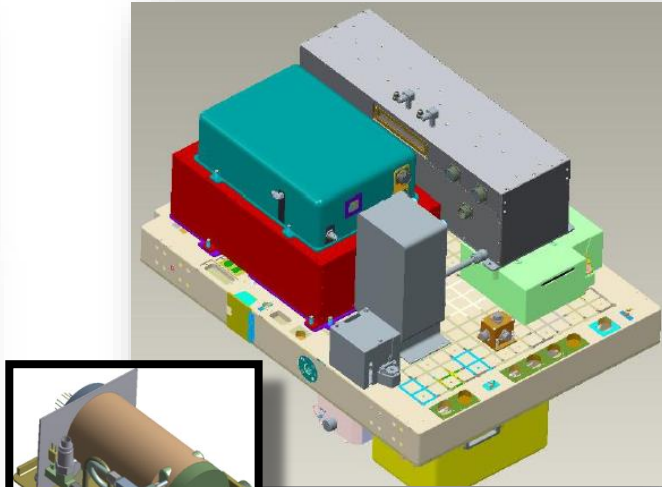
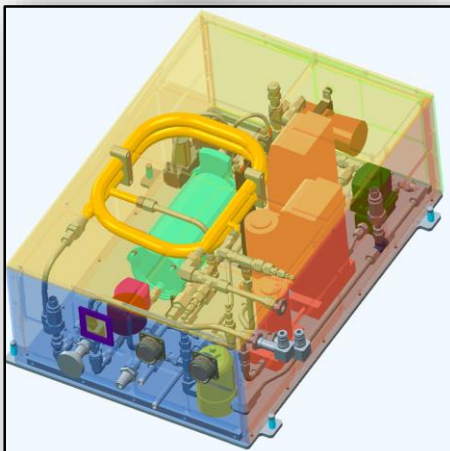
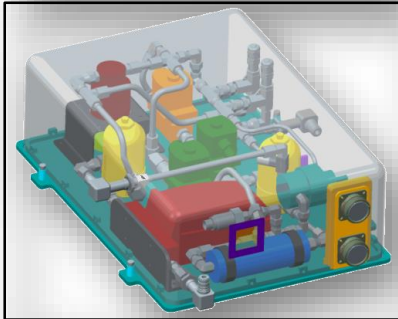
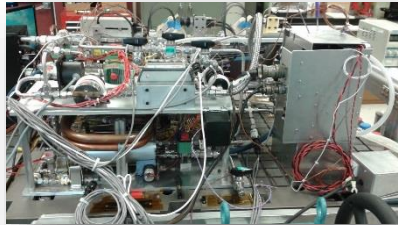

BCIS-RHDM

BCAP-RHDM

BCAPIS

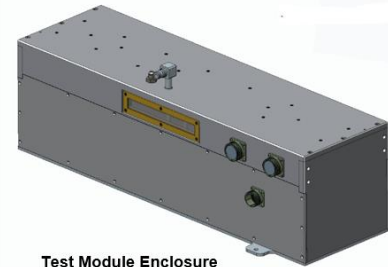
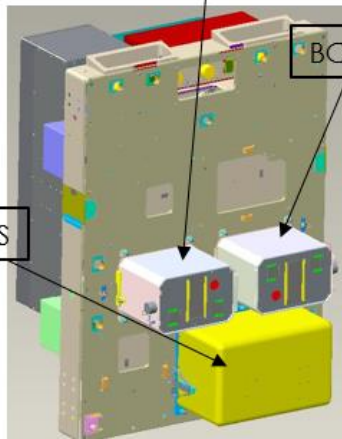

Test Module Enclosure

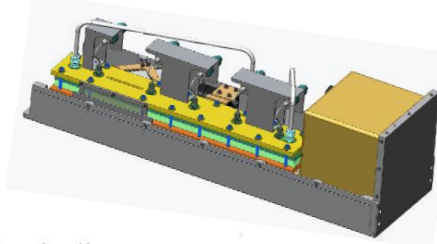

Camera Assembly

Mirror Assembly

Enclosure Base

Test Module

Module Support

Pressure Transducer

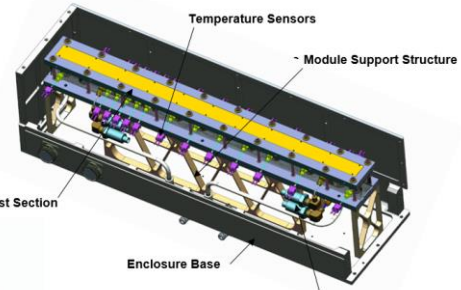

Temperature Sensors

Module Support Structure

HT Test Section

Enclosure Base

Pressure Transducers

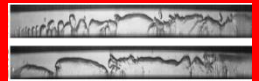

Concluding Remarks

- ❑ Flow Boiling and Condensation engineering team preparing for the Critical Design Review
- ❑ Design of flight hardware for FBCE
- ❑ Design of Engineering Models (EM) for CM-HT and Fluid system modules
- ❑ Development of Brassboard/EM hardware for future engineering testing of fluid system, software and avionics

Acknowledgement

- Authors acknowledge NASA's support to the Flow Boiling and Condensation Experiment

Questions??