

# Results for the Brine Evaporation Bag (BEB) Brine Processing Test

Lance Delzeit,<sup>1</sup> Michael Flynn<sup>2</sup> and John Fisher<sup>3</sup>  
*NASA Ames Research Center, Moffett Field, Ca, 93045*

Hali Shaw<sup>4</sup>  
*UCSC, Moffett Field, Ca, 93045*

Brian Kawashima<sup>5</sup>  
*USRA, Moffett Field, Ca, 93045*

David Beeler<sup>6</sup>  
*Bionetics, Moffett Field, Ca, 93045*

and

Kevin Howard<sup>7</sup>  
*CSS-Dynamac, Moffett Field, Ca, 93045*

**The recent Brine Processing Test compared the NASA Forward Osmosis Brine Dewatering (FOBD), Paragon Ionomer Water Processor (IWP), UMPQUA Ultrasonic Brine Dewatering System (UBDS), and the NASA Brine Evaporation Bag (BEB). This paper reports the results of the BEB. The BEB was operated at 70 °C and a base pressure of 12 torr. The BEB was operated in a batch mode, and processed 0.4L of brine per batch. Two different brine feeds were tested, a chromic acid-urine brine and a chromic acid-urine-hygiene mix brine. The chromic acid-urine brine, known as the ISS Alternate Pretreatment Brine, had an average processing rate of 95 mL/hr with a specific power of 5kWhr/L. The complete results of these tests will be reported within this paper.**

## Nomenclature

<i>AES</i>	=	Advanced Exploration Systems
<i>BEB</i>	=	Brine Evaporation Bag
<i>Cr</i>	=	Chromium
<i>CM</i>	=	crew member
<i>ePTFE</i>	=	expanded polytetrafluoroethylene
<i>ESM</i>	=	Equivalent System Mass
<i>FOBD</i>	=	Forward Osmosis Brine Dewatering
<i>g</i>	=	gram
<i>hr</i>	=	hour
<i>H.C.</i>	=	humidity condensate
<i>in<sup>2</sup></i>	=	square inch

---

<sup>1</sup> Physical Scientist, Bioengineering Branch, and Mail Stop 239-15.

<sup>2</sup> Engineer, Bioengineering Branch, and Mail Stop 239-15.

<sup>3</sup> Engineer, Bioengineering Branch, and Mail Stop 239-15.

<sup>4</sup> Engineer, Bioengineering Branch, and Mail Stop 239-15.

<sup>5</sup> Engineer, Bioengineering Branch, and Mail Stop 239-15.

<sup>6</sup> Engineer, Bioengineering Branch, and Mail Stop 239-15.

<sup>7</sup> Engineer, Bioengineering Branch, and Mail Stop 239-15.

<i>in</i> <sup>3</sup>	= cubic inch
<i>ISS</i>	= International Space Station
<i>IWP</i>	= Ionomer Water Processor
<i>kg</i>	= kilogram
<i>kW</i>	= kilowatts
<i>kWhr/L</i>	= kilowatt hour per liter
<i>L</i>	= Liter
<i>L/day</i>	= Liter per day
<i>m</i> <sup>3</sup>	= cubic meter
<i>mg/kg</i>	= milligram per kilogram
<i>mg/L</i>	= milligram per liter
<i>mL</i>	= milliliter
<i>mL/hr</i>	= milliliter per hour
<i>mL/min</i>	= milliliter per minute
<i>PP</i>	= Polypropylene
<i>ppb</i>	= Parts per billion
<i>ppm</i>	= Parts per million
<i>PTFE</i>	= Polytetrafluoroethylene
<i>PU</i>	= Polyurethane
<i>RTD</i>	= resistance temperature detector
<i>std. dev.</i>	= standard deviation
<i>TCCS</i>	= Trace Contaminant Control System
<i>UBDS</i>	= Ultrasonic Brine Dewatering System
<i>UPA</i>	= Urine Processing Assembly
<i>VCD</i>	= Vapor Compression Distillation
<i>W</i>	= watts

## I. Introduction

THE Advanced Exploration Systems (AES) Program wanted to determine the performance characteristics of the brine dewatering technologies currently existing within NASA. Thus, the Brine Evaporation Bag (BEB) System,<sup>1-4</sup> the Ionomer Water Processor (IWP),<sup>5</sup> the Ultrasonic Brine Dewatering System (UBDS),<sup>6</sup> and the Forward Osmosis Brine Dryer (FOBD)<sup>7</sup> all participated in the AES Brine Processing Test in order to determine their performance characteristics.<sup>8</sup> The Brine Processing Test included the testing of two different waste streams: the ISS Alternate Pretreatment Brine and the Hygiene Brine. The motivation for the Brine Processing Test was to test the various technologies ability to recover additional water from the brine waste in order to make the ISS water self-sufficient and to enable long duration deep space missions.

The ISS Alternate Pretreatment is a reformulation of the current urine pretreatment which is only able to recover 75% of the water. At 75% water recovery, the ISS is running at a water deficit. In order to alleviate this water deficit, the AES Program is investigating an alternate pretreatment formulation in order to increase the water recovery of the ISS primary water processor. The exact formulation of the ISS Alternate Pretreatment Formulation is currently proprietary.

Future long duration space missions are expected to include hygiene activities, and so a second test solution known as Hygiene brine was also tested. It is a mixture of the ISS Alternate Pretreatment with the expected hygiene waste stream.

## II. The BEB System

The BEB System (Figure 1) is a potential solution to the issues with the ISS water resupply and water launch mass for deep space missions. The BEB system is composed of the BEB and the BEB Evaporator. The BEB is a completely enclosed bag into which the brine waste is injected. The BEB uses membranes, which allows gases, including water vapor, to leave the bag while keeping the nonvolatile solids and liquids contained. Thus, the BEB system is able to dewater brine waste while keeping the acid, Cr(VI), and other hazardous non-volatiles contained within the bag. The BEB Evaporator provides the vacuum and heating required to dewater the brine.

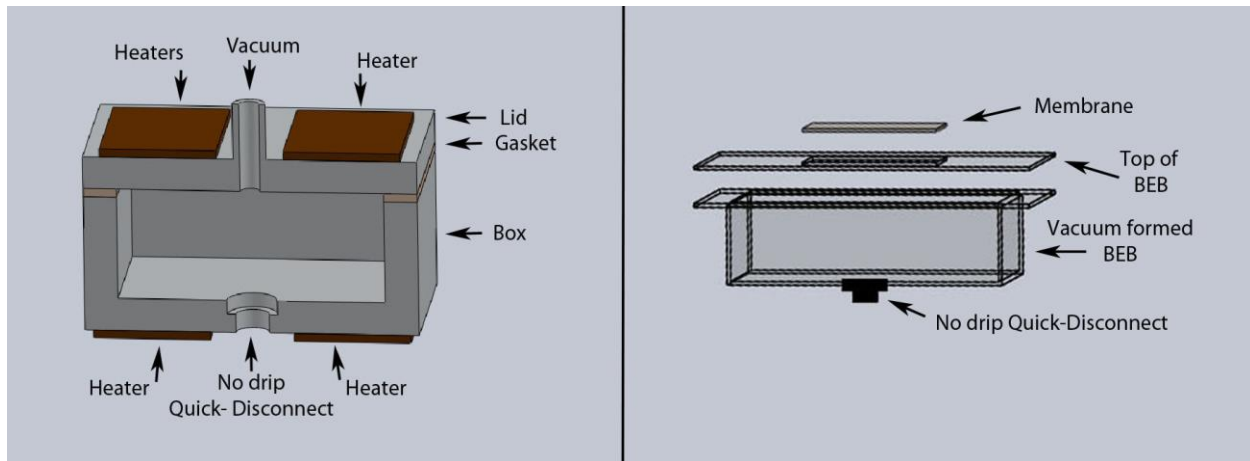
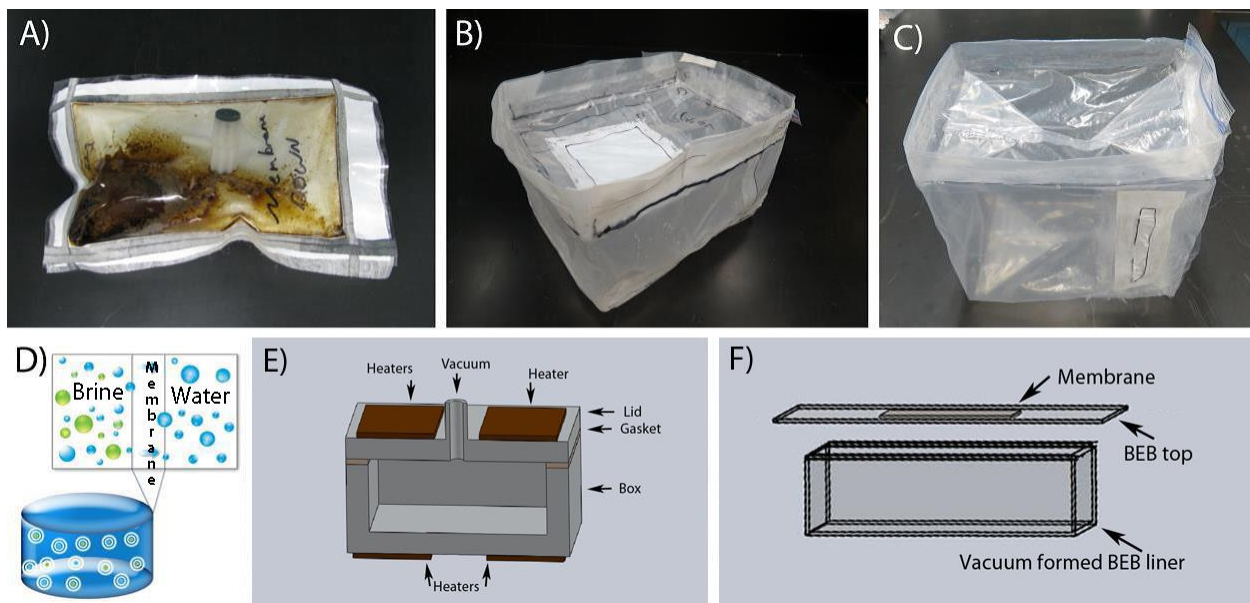

**Figure 1. Conceptual drawings of the continuous-fill BEB Evaporator (Left) and the continuous-fill BEB (Right) as they would be built for the BEB System.**

The BEB System, by design, has two dissimilar containment barriers, a chemically resistant polymer bag, the BEB, and a hard metal shell, the BEB Evaporator, to keep the brine contained.

### A. The BEB

The Brine Evaporation Bag (BEB) is specifically designed to be impervious to the failure mechanisms of the ISS UPA, which allows more water to be recovered from brine waste. A proof-of-concept BEB has demonstrated the ability of dewatering a phosphoric acid brine waste to 99% water recovery (Figure 2A),<sup>2</sup> compared to the 74% of the ISS UPA alone.



**Figure 2. A) “Flat” BEB containing the brine residue used to demonstrate functionality and 99% water recovery. B) and C) Further refined BEBs built to demonstrate functionality within a vacuum oven. D) Conceptual model showing how the BEB works. The higher fidelity E) BEB and F) Breadboard BEB Evaporator being tested.**

The primary failure mechanism of the ISS UPA is the precipitation and scaling that occurs from the dewatering of the wastewater at high water recovery ratios. During operation, the precipitates deposit on the heat transfer surfaces and moving parts of the ISS UPA and eventually cause them to fail. However, the BEB system

accomplishes brine dewatering by containing the brine waste within the BEB, completely isolating it from the rest of the brine water recovery system. Thus, the potential scaling or other fouling is kept within the BEB away from any components that could be fouled or caused to fail.

Additionally, the BEB is a disposable bag that can be used and discarded prior to its own intrinsic failure mode, i.e., failure of the membrane because of long duration exposure to the brine. The concept of operation is that the BEB would be used for a single batch that would be processed within seven days, where several months are required for the membrane to eventually foul and fail. Long before the membrane failure would occur, the BEB would be disposed of to its final depository where membrane failure would no longer be an issue.

A BEB is estimated to weigh between 0.05 kg and 0.1 kg and will process 4 L – 30 L of brine per BEB. The size of the BEB inside the Breadboard BEB Evaporator is 5" x 5" x 2".

## B. The BEB Evaporator

The BEB Evaporator will provide the structural support for the BEB, the energy for the evaporation of the water from the brine within the BEB, and the vacuum to reduce the boiling point of the brine to make this a low temperature process. Proof-of-concept tests were conducted by placing a BEB within a vacuum oven to simulate the BEB Evaporator.<sup>4</sup> These tests demonstrated a production rate of 1.5 L/day at 70 °C and 0.5 L/day at 50 °C (Figure 2B and Figure 2C). A specifically designed BEB Evaporator could therefore provide the brine process rate required for the ISS (Figure 1 and Figure 3).

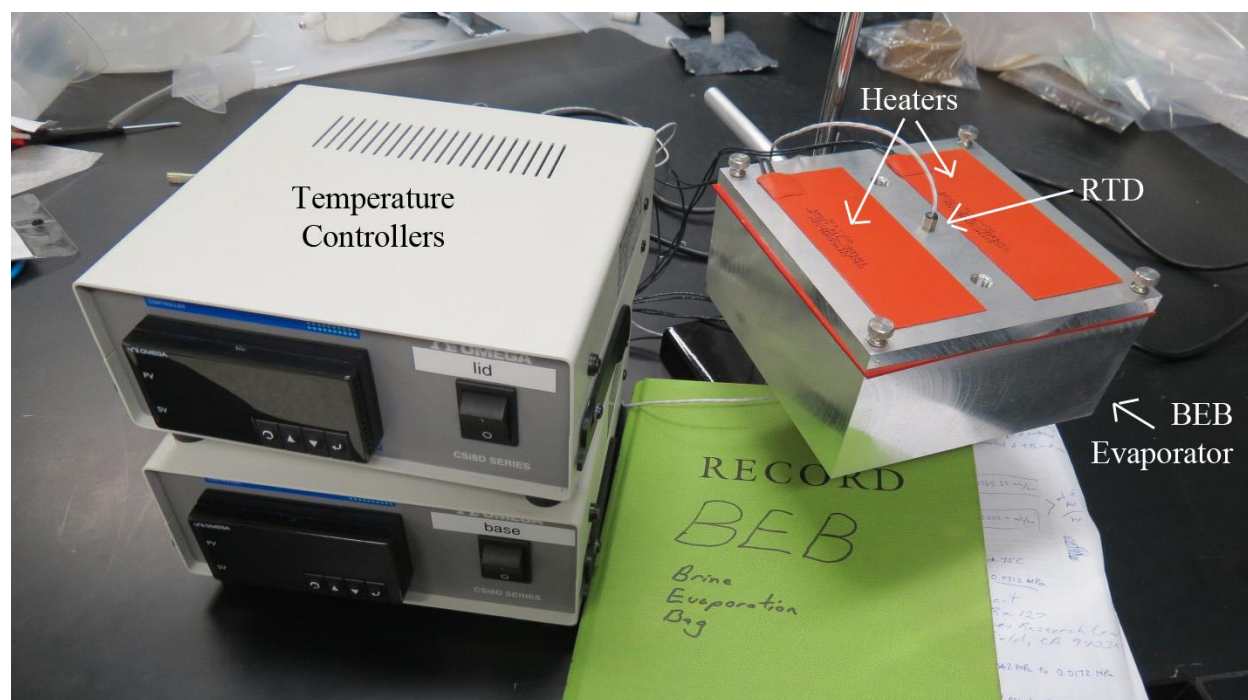

Figure 3. Breadboard BEB Evaporator.

## III. Experimental

For the brine processing test, the Breadboard BEB System which runs in a batch mode of operation was chosen due to the limited quantity of brine that was available for the testing. The Breadboard BEB Evaporator was lined with a polyurethane bag to simulate the resistance to heat flow that would be experienced through the BEB. The chamber was filled with ~400 mL of brine. The membrane top was then installed completely sealing the BEB Evaporator chamber from the vacuum. The BEB Evaporator was pulled under vacuum. The base vacuum was nominally 10 torr with higher operating pressure due to the evaporation of water from the brine. The BEB Evaporator was heated to 70 °C. A 0.1 L/min purge gas through the BEB Evaporator was also used. The external dimensions of the Breadboard BEB Evaporator are 6" x 6" x 2.5".

The steam produced by the process was collected using an ice condenser. 0.1% of the effluent gas from the process was collected on a Tenax TA column and analyzed by headspace GCMS.

The process ran until the observed water production rate was less than 10 mL/hr.

Two different brines were processed. The first was a urine brine containing chromic acid known as ISS Alternate Pretreatment Brine.<sup>8</sup> This brine is an 85% (v/v) dewatered pretreated urine feed that is being developed to replace the currently used ISS urine pretreatment method. This new pretreatment method is being developed to allow the ISS primary water processor to recover a high water recovery rate. The second brine, known as Hygiene Brine,<sup>8</sup> is a mixture of approximately 45% ISS Alternate Pretreatment Brine and 55% hygiene wastewater composed of an expected future hygiene feed stream. Each brine was tested in triplicate. Feed brine, brine residue, and water condensate samples were also collected for analysis.

#### IV. Results

Tests were conducted in triplicate for both the ISS Alternate Pretreat Brine and the hygiene brine. The three runs for the ISS Alternate Pretreat Brine were highly reproducible with no leakage of the brine through the membrane.

The three runs for the hygiene brine were the first attempts at running a surfactant containing brine through a BEB. These runs showed the need for further development of the BEB system with hygiene brines.

#### C. Results of the ISS Alternate Pretreatment Brine Runs

Three runs using the ISS Alternate Pretreatment Brine were conducted. These three runs were highly reproducible with no sign of membrane leakage (Figure 4). The exterior of the membrane (Figure 4A, B, and C) remained a pristine white while the inside of the membrane (Figure 4D, E, and F) was coated with brine.

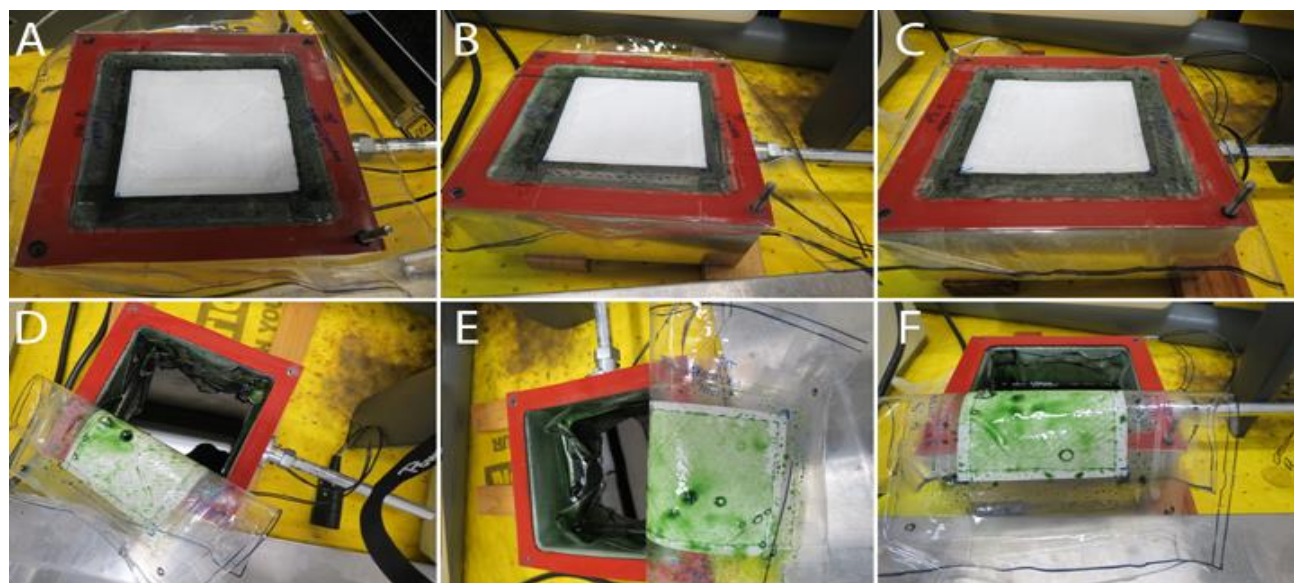

**Figure 4. Images of the membrane and ISS Alternate Pretreatment Brine after the run. A, B, and C show the exterior of the membrane after run for runs one, two, and three, respectively. D, E, and F show the interior of the chamber and the brine residue for the first, second, and third runs, respectively.**

The ARC in-house chemical analysis of the feed and condensate are shown in Table 1. The concentration of the ions within the condensate for the three ISS Alternate Pretreatment Brine runs were highly reproducible with the concentration of all ions being less than <math>0.5</math> ppm except for chloride which was less than 6 ppm, sulfate which was less than 3 ppm, and ammonium which was less than 2 ppm.

Cr analysis is presented in Table 2. The BEB System demonstrated the ability to produce condensate with no detectible (<math><0.00010</math> ppm) Cr(VI). The concentration of Cr(III) within the condensate is 0.013 and 0.035 mg/L (ppm). The concentration of Cr that was reported for the condensate of the Wiped Film Rotating Disk (WFRD) in the Exploration Life Support Distillation Down Select Test (ELSDDST) boil-off of 2010 was 0.0285 and 0.0200.<sup>9</sup> It is therefore proposed that the Cr(III) within the BEB's condensate is a result of the Stainless Steel construction of the BEB Evaporator, pumps, and tubing, and not leakage of Cr through the membrane of the BEB.

**Table 1. BEB chemical analysis.**

Sample I.D.	Sodium	Ammonium	Potassium	Magnesium	Calcium	Chloride	Nitrite	Bromide	Nitrate	Phosphate	Sulfate
BEB CrBrine Feed	5647	1421	6370	244	414	2276	ldl	ldl	ldl	8767	1329
BEB CrBrine Condensate Run1	0.5	2.0	<0.5	<0.5	<0.5	4.0	<0.5	<0.5	<0.5	<0.5	2.1
BEB CrBrine Condensate Run2	0.8	1.3	<0.5	<0.5	<0.5	1.4	<0.5	<0.5	<0.5	<0.5	1.6
BEB CrBrine Condensate Run3	0.8	1.8	<0.5	<0.5	<0.5	6.2	<0.5	<0.5	<0.5	<0.5	2.8
BEB Hygiene Brine Cond. Feed	5993	868	3771	ldl	ldl	9478	ldl	ldl	ldl	42242	7469
BEB Hygiene Brine Condensate Run1	<0.5	1.9	<0.5	<0.5	<0.5	2.0	<0.5	<0.5	<0.5	<0.5	1.6
BEB Hygiene Brine Condensate Run2	16.5	14.0	14.5	1.0	1.5	22.8	<0.5	<0.5	0.7	102	28.2
BEB Hygiene Brine Condensate Run2 - Confirmation	16.7	13.3	13.5	<0.5	<0.5	22.8	<0.5	<0.5	0.7	103	27.8
BEB Hygiene Brine Condensate Run3	8.9	11.0	8.9	<0.5	1.1	42.8	ldl	ldl	ldl	47.2	16.3
	ldl - less than the detection limit at the dilution required.										
	All results reported in ppm (ug/ml) unless otherwise indicated.										
Sample I.D.	TOC	pH	Cond(uS)	%TSS	%TDS	%TSS					
BEB CrBrine Feed	111400	2.0	*	*	*	*					
BEB CrBrine Condensate Run1	204	3.3	232	*	*	*					
BEB CrBrine Condensate Run2	186	3.3	240	*	*	*					
BEB CrBrine Condensate Run3	185	3.4	236	*	*	*					
BEB Hygiene Brine Cond. Feed	21320	2.2	*	*	*	*					
BEB Hygiene Brine Condensate Run1	164	3.4	194	*	*	*					
BEB Hygiene Brine Condensate Run2	451	3.3	529	*	*	*					
BEB Hygiene Brine Condensate Run3	207	3.2	402	*	*	*					
	*unable to determine due to presence of chromic acid										
	All results reported in ppm (ug/ml) unless otherwise indicated.										

**Table 2. Cr Analysis of the Feed, Condensate and Residue from Accutest Laboratories.**

Client Sample ID:		BEB FEED BRINE	BEB RUN 2 CONDENSATE	BEB RUN 3 CONDENSATE	IWP BRINE TEST 1, DAY 6 RESIDUE
Lab Sample ID:		C35669-2	C35669-6	C35669-7	C35669-1
Date Sampled:		08/14/2014	08/21/2014	08/25/2014	08/04/2014
Matrix:		Water	Water	Water	Water
<b>Metals Analysis</b>					
Chromium	ug/l	3660000	12.5	34.7	6870000
<b>General Chemistry</b>					
Chromium, Hexavalent	mg/l	0.53 <sup>a</sup>	0.00010 U <sup>a</sup>	0.00010 U <sup>b</sup>	2.6 <sup>a</sup>
Chromium, Trivalent	mg/l	3660 <sup>c</sup>	0.013 <sup>c</sup>	0.035 <sup>c</sup>	6870 <sup>c</sup>
Client Sample ID:		BEB RUN 1 BRINE RESIDUE	BEB RUN 2 BRINE RESIDUE	BEB RUN 3 BRINE RESIDUE	
Lab Sample ID:		C35669-3	C35669-4	C35669-5	
Date Sampled:		08/20/2014	08/21/2014	08/25/2014	
Matrix:		Soil	Soil	Soil	
<b>Metals Analysis</b>					
Chromium	mg/kg	13400	13800	13300	
<b>General Chemistry</b>					
Chromium, Hexavalent	mg/kg	1.6	1.4	2.4	
Chromium, Trivalent	mg/kg	13400 <sup>c</sup>	13800 <sup>c</sup>	13300 <sup>c</sup>	

U for the concentration of Cr(VI) within the BEB's condensate samples means that the concentration is less than the 0.00010 mg/l (<0.1 ppb) detection limit of the method used by Accutest Laboratories.

The performance of the BEB System is shown in Table 3, Table 4, and Table 5. Table 3 is the raw data collected. Table 4 shows the calculated performance of the BEB System. Table 5 shows the percent mass reduction.

The "mean time" presented within Table 4 is used for the plotting of the associated value in the middle of the time increment for the calculation. For example, the production rate for the very first reading of run 1 was taken at 0.25 hr; the point is plotted in the middle of that time increment at 0.125 hr.

The Specific Power is calculated as cumulative (from the beginning of the run) and instantaneous (for the time segment of that data point). The cumulative is the Specific Power normally reported within Life-Support. The instantaneous specific power is plotted to determine if there is a point at which the cost of recovering water becomes more expensive than launching it.

The last 2% of the water collected from the brine costs approximately 40 kWhr/L. An in-depth systems analysis needs to be done to determine at what point it is no longer cost-effective to collect the water.

**Table 3. Raw data for the three ISS Alternate Pretreatment brine runs.**

Raw Data														
Run 1					Run 2					Run 3				
Time	Vol	Energy	Temp	Vac	Time	Vol	Energy	Temp	Vac	Time	Vol	Energy	Temp	Vac
(Hrs)	(mL)	(kWhr)	( C )	(in Hg Vac)	(Hrs)	(mL)	(kWhr)	( C )	(in Hg Vac)	(Hrs)	(mL)	(kWhr)	( C )	(in Hg Vac)
0	0	0	20	29.1	0	0	0	20	28.8	0	0	0	18	29
0.25	5	0.132	50	28.5	0.3	10	0.173	58	27.9	0.13	0	0.05	36	28.6
0.75	70	0.412	69	27.5	0.55	35	0.302	66	27.4	0.38	10	0.185	60	28.6
1.25	130	0.632	70	27.9	1.05	110	0.572	70	27.7	0.63	40	0.313	67	27.4
1.75	185	0.862	70	26.4	1.55	170	0.794	70	27.7	1.13	115	0.553	70	27.7
2.25	225	1.087	70	28.2	2.05	223	1.023	70	27.7	1.63	175	0.796	70	27.7
2.75	260	1.314	70	27.1	2.55	265	1.259	70	27.9	2.13	215	1.091	70	28
3.25	280	1.533	70	28.6	3.05	295	1.485	70	28.2	2.63	250	1.246	70	28.1
3.75	290	1.735	70	27.8	3.55	305	1.689	70	28.9	3.13	275	1.465	70	28.4
4.25	300	1.943	70	28.7	4.05	310	1.889	70	28.9	3.63	295	1.667	70	28.6
4.75	305	2.146	70	29.4	4.55	310		70	28.9	4.13	300	1.863	70	29.4
										4.63	300		70	29.4

**Table 4. Calculated results for the three ISS Alternate Pretreatment brine runs.**

Calculated Results														
Run 1					Run 2					Run 3				
Median	Production	Cumulative	Instantaneous	Percent	Median	Production	Cumulative	Instantaneous	Percent	Median	Production	Cumulative	Instantaneous	Percent
Time	Rate	Power	Power	Recovery	Time	Rate	Power	Power	Recovery	Time	Rate	Power	Power	Recovery
(Hrs)	(mL/hr)	(kWhr/L)	(kWhr/L)	(%)	(Hrs)	(mL/hr)	(kWhr/L)	(kWhr/L)	(%)	(Hrs)	(mL/hr)	(kWhr/L)	(kWhr/L)	(%)
0.125	20	26.4	26.4	1.6	0.15	33.33	17.3	17.3	3.2	0.07	0	-	-	0.0
0.5	130	5.9	4.3	23.0	0.425	100	8.6	5.2	11.3	0.26	40	18.5	13.5	3.3
1	120	4.9	3.7	42.6	0.8	150	5.2	3.6	35.5	0.51	120	7.8	4.3	13.3
1.5	110	4.7	4.2	60.7	1.3	120	4.7	3.7	54.8	0.88	150	4.8	3.2	38.3
2	80	4.8	5.6	73.8	1.8	106	4.6	4.3	71.9	1.38	120	4.5	4.1	58.3
2.5	70	5.1	6.5	85.2	2.3	84	4.8	5.6	85.5	1.88	80	5.1	7.4	71.7
3	40	5.5	11.0	91.8	2.8	60	5.0	7.5	95.2	2.38	70	5.0	4.4	83.3
3.5	20	6.0	20.2	95.1	3.3	20	5.5	20.4	98.4	2.88	50	5.3	8.8	91.7
4	20	6.5	20.8	98.4	3.8	10	6.1	40.0	100.0	3.38	40	5.7	10.1	98.3
4.5	10	7.0	40.6	100.0						3.88	10	6.2	39.2	100.0

The Total Solids analysis of the brine residue (Table 5) was performed by drying the brine residual in a vacuum oven at 50 °C and 48 torr with a 1 L/min air flow. At 48 torr, the boiling point of water is 37 °C. Thus 50 °C is 13 °C over the boiling point of water for the applied pressure. The average % Water Recovery that was obtained by the BEB System was 98% water recovery from the brine feed. This gives a total % water recovery of 99.7% from the original urine feed compared to the current 74% obtainable by the ISS UPA.

**Table 5. Measured Properties.**

	ISS Alternate Pretreat			Hygiene		
	Run 1	Run 2	Run 3	Run 1	Run 2	Run 3
Brine Residue	131.5	131.6	129.3	68.8	73.3	64.8
Brine Mass	450.0	452.4	444.1	420.0	423.2	425.6
% Mass Reduction	71%	71%	71%	84%	83%	85%
% Water in Residue 1		5.5	4.2	10.7	9.8	
% Water in Residue 2		5.0	3.3			
% Water Recovery 1 (Absolute)		97.8	98.3	97.9	98.1	
% Water Recovery 2 (Absolute)		98.0	98.7			
Avg % Water Recovery		98.2		98.0		
Std. Dev. % Water Recovery		0.4		0.1		
Max % Water Recovery due to Humidity re-adsorption		93.3	93.1			



It was also observed that as the brine residual was exposed to air, it quickly regained water from the humidity within the air. This would be largely due to the hygroscopic nature of the brine residue, i.e., the acid which the brine contains. If all of the water remaining within the brine residue was associated with only the acid, it would be less than a 1/100<sup>th</sup> hydrate (one water molecule per 100 acid molecules). As the brine continued to be exposed to air over a 24 hr period, the thick paste of a residue turned into a viscous liquid and began to run. Figure 5 shows the brine residue as a thick paste after processing, and a viscous liquid after adsorbing atmospheric water.

After 24 hr of air exposure, the % Water Recovery decreased 98% to 93%. Therefore, the method of brine storage after dewatering is important to the extent of water recovery that should be performed. For example, if 100% water recover was a necessity, then the brine would need to be stored in a hermetically sealed container to prevent it from re-adsorbing water, i.e., prevent it from effectively decreasing the % water recovery that was obtained.

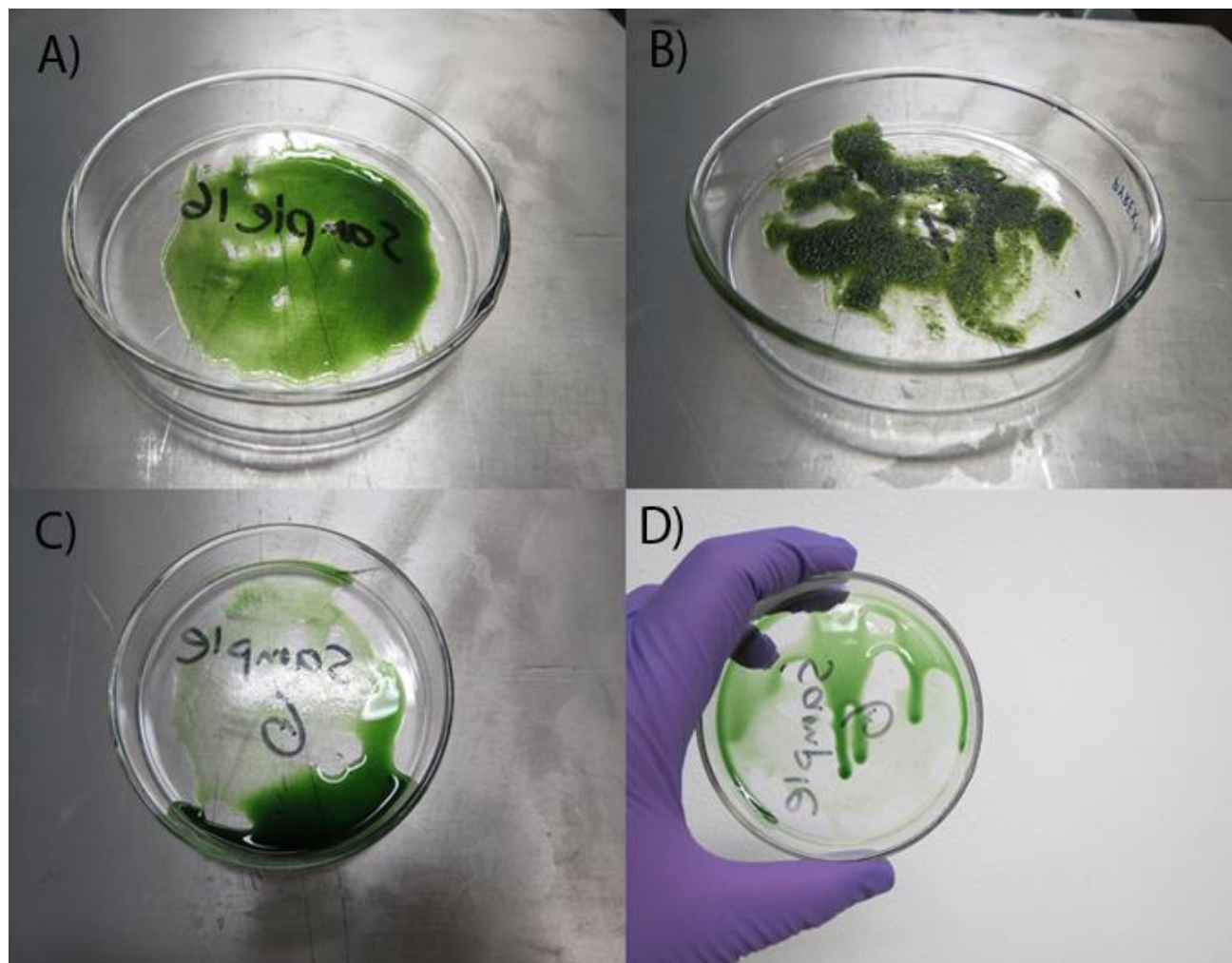

**Figure 5. Shows A) the ISS Alternate Pretreatment brine and B) Hygiene brine residues as a thick paste, and C) and D) an ISS Alternate Pretreatment brine as a viscous liquid after adsorbing atmospheric water.**

Figure 6 and Figure 7 show the production rate and cumulative water collection of the three runs. As the system is heated to the operating temperature (70 °C), the BEB's production rate rapidly increased over the first 30 minutes of each run. At this point the production rate is nominally 150 mL/hr. As the brine is dewatered, the

production rate linearly decreased with time until the brine is “100%” dewatered, nominally 4 hours later. The final residue produced from the dewatering is a thick paste.

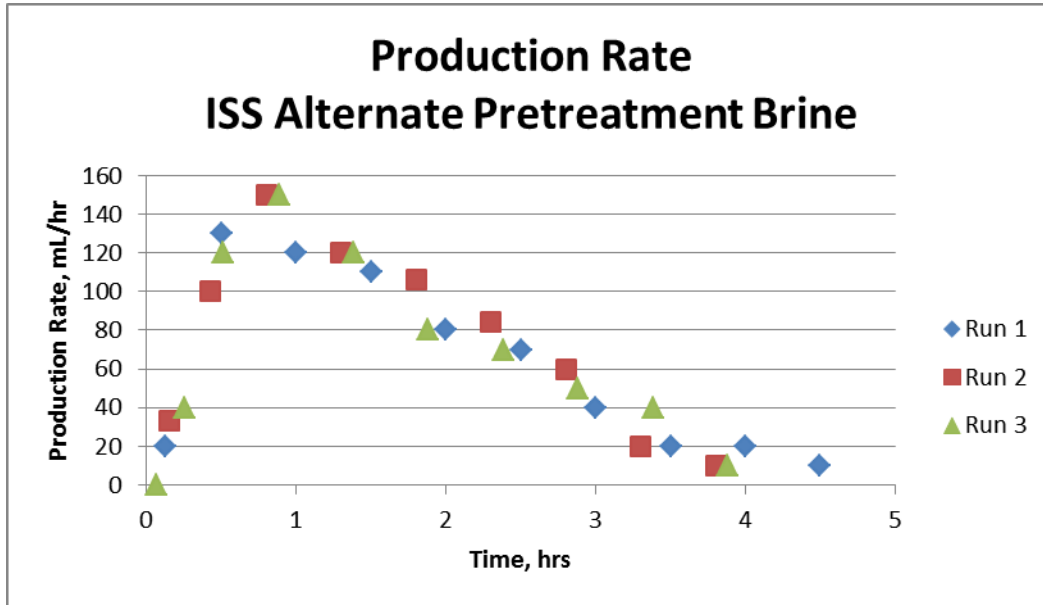

Figure 6. Production rate for the three ISS Alternate Pretreatment Brines.

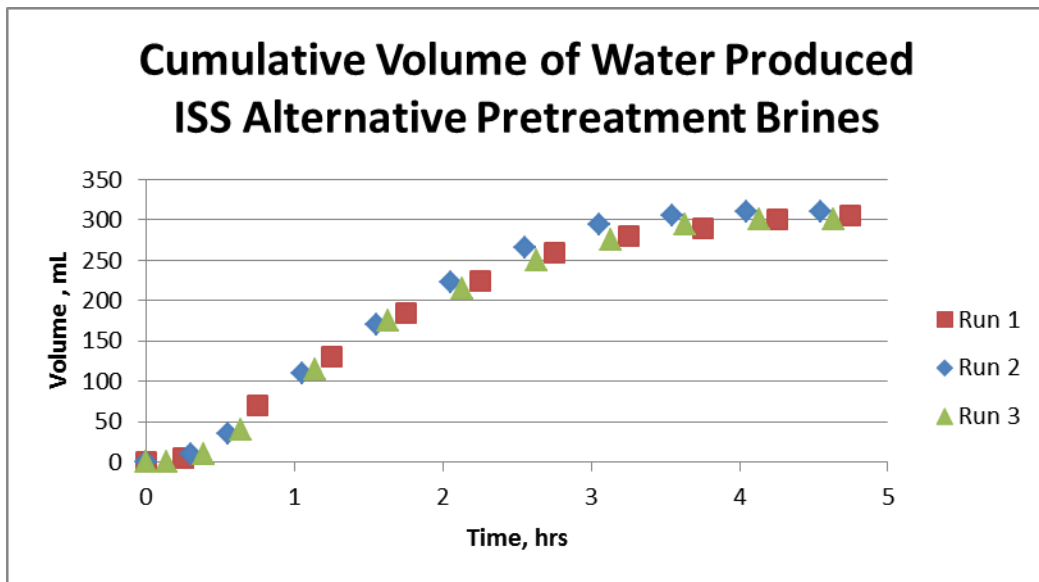

Figure 7. The cumulative water collected for each of the three ISS Alternate Pretreatment Brines.

The BEB was operated to 100% water recovery of the ISS Alternate Pretreatment brine. However, the comparison testing only requires a water recovery of 86.7% for the ISS Alternate Pretreatment brine. Figure 8 shows the percent water recovery versus time. The BEB System dewatered 0.449 kg (0.4L) of ISS Alternate Pretreatment brine runs to 86.7% water recovery in 2.77 hr (std.dev. 0.14hr). This is an average processing rate of 95 mL/hr with a specific power of 5.02 kWhr/L (std.dev. 0.20kWhr/L) (Figure 8). For the 4-crew, 360-day proposed mission, 899 kg of ISS Alternate Pretreatment brine would need to be processed. The as-tested BEB system would be able to process all of the brine in 231 days. It would also require 195 bags.

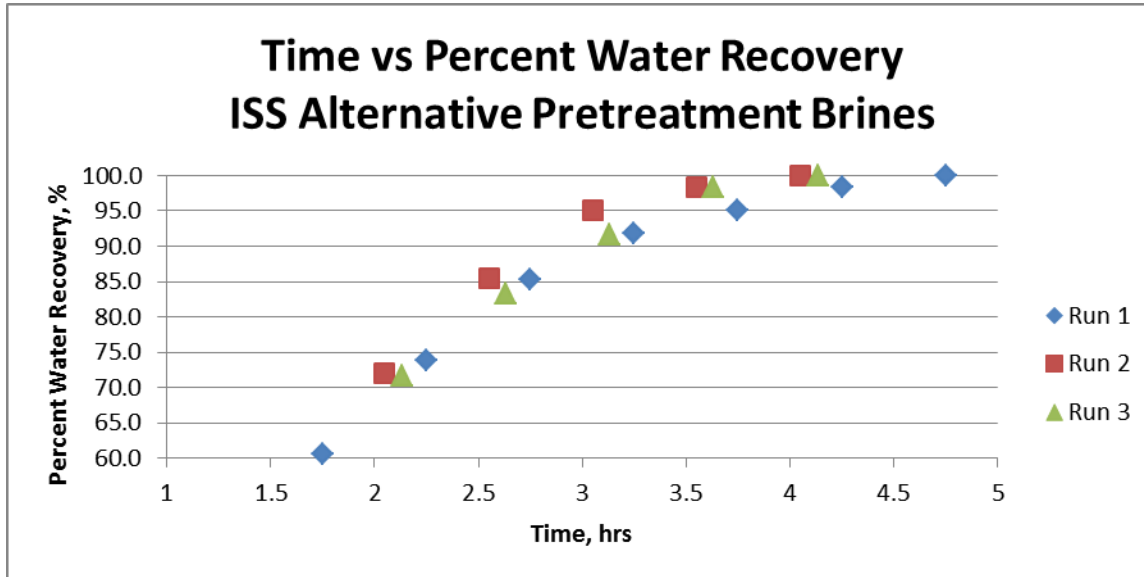

Figure 8. Plot showing the time required to reach a given water recovery.

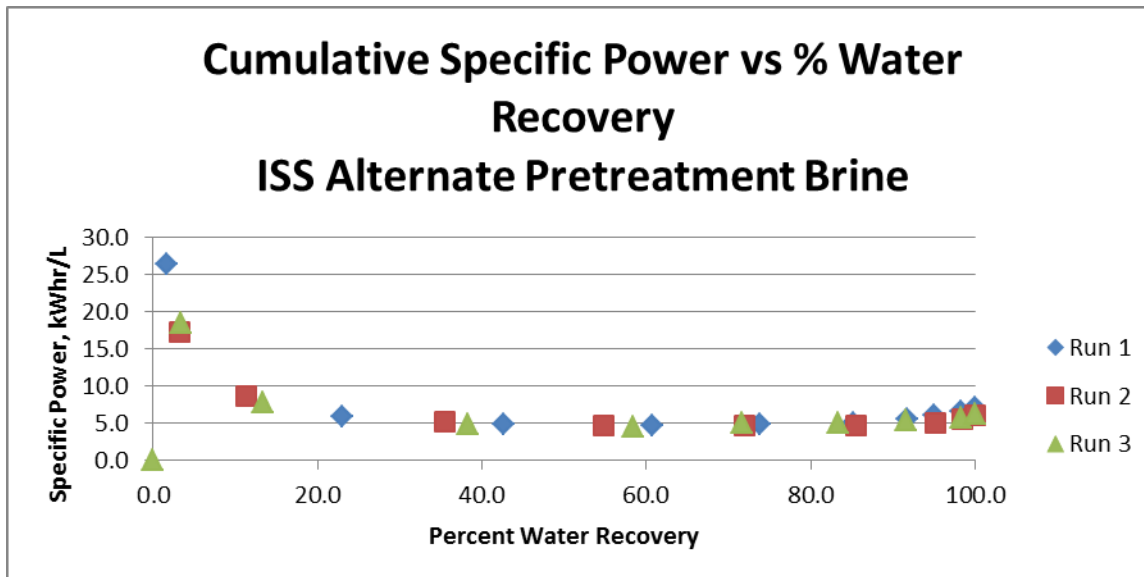

Figure 9. The graph shows what the specific power that will be required for a run ending at the give percent water recovery. The initial high specific power is due to startup costs. The only slight increase at the end of the run is due to the averaging of the higher costs over the entire run.

#### D. Results of the Hygiene Runs

Three runs using the Hygiene brine were performed (Figure 10). The data for these runs were more scattered than the ISS Alternate Pretreatment brine runs, yet still had a decent reproducibility. The first run used a simple single layer of ePTFE membrane as the ISS Alternate Pretreatment brine runs had used. The ePTFE membrane failed to contain the Hygiene Brine as was expected. In an attempt to solve the membrane leakage, the

second run used a multi-layered membrane construct and a higher lid temperature in an attempt to prevent the Hygiene Brine from penetrating through all of the layers of the membrane construct. The membrane construct was built from three layers of repeating ePTFE membrane, PP spunbond, and PU screen spacer. This membrane construct did decrease the leakage of the Hygiene Brine, however, there was still leakage. The third run used an oleophobic ePTFE membrane in an attempt to prevent membrane leakage. Oleophobic membranes are both oil-phobic and hydrophobic.

Figure 10 A, B, and C show wetting of the ePTFE membrane by the Hygiene Brine. Run 2 had significantly less wetting of the membrane than the first run. Additionally, the exterior surface of the membrane from the third run was wiped with a white cloth after the run, and no green residue was present, signifying no brine residue was on the exterior of the membrane. Finally, the screen spacer that is against the ePTFE membranes is shown in Figure 11. The screen from run 1 using the hydrophobic ePTFE membrane was completely covered with brine residue, however, the screen from run 3 using the oleophobic ePTFE membrane had almost no residue. Additionally, the contamination was limited to the screen area along the edge of the oleophobic membrane. Inspection of the membrane heat seals indicate that the heat seal of the oleophobic membranes were not as good as the heat seals of the hydrophobic membranes. This may signify that the leakage is not a membrane issue but rather a heat sealing issue.

The results, shown in Figure 10 and Figure 11, show that the hydrophobic membrane does not work for a Hygiene Brine containing surfactants. However, the oleophobic membrane could potentially be built into a construct that would work. A third type of PTFE membrane is also available, which is based upon ion channels, which can exclude both hydrocarbons and ions. An example of this type of membrane is Nafion and according to the literature, it is not susceptible to surfactant induced leakage. Future plans for dewatering Hygiene Brines will include the investigation of oleophobic and ion channel PTFE membranes.

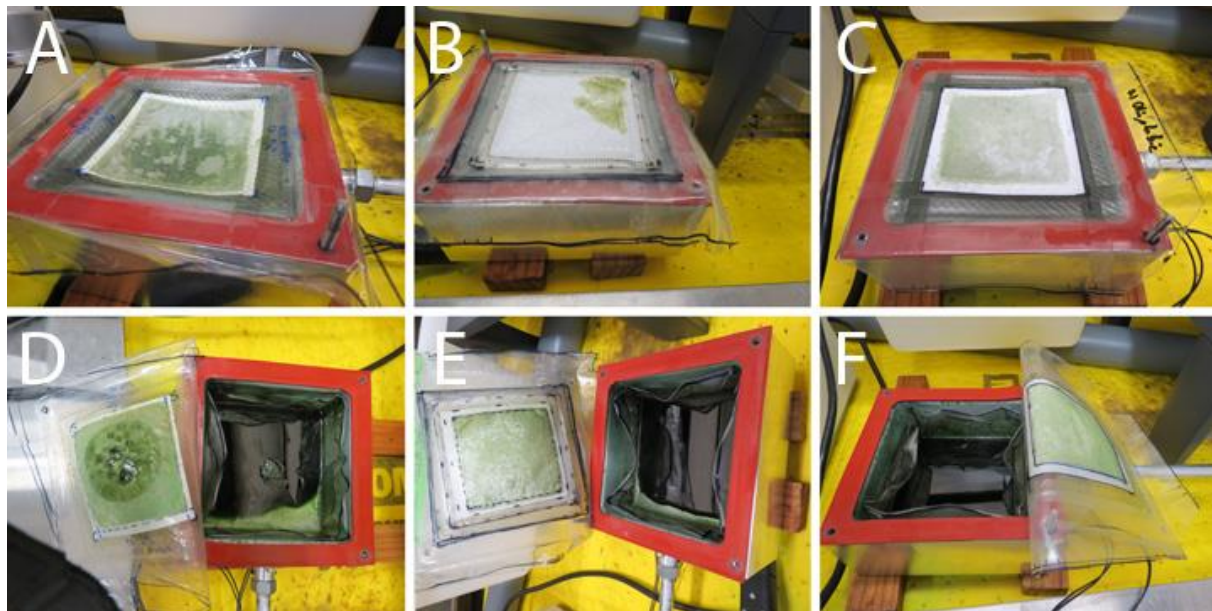

**Figure 10. Images of the membrane and Hygiene Brine residue after the run. A, B, and C show the exterior of the membrane after run one, two, and three, respectively. D, E, and F show the inside of the chamber and the brine residue for the first, second and third runs, respectively.**

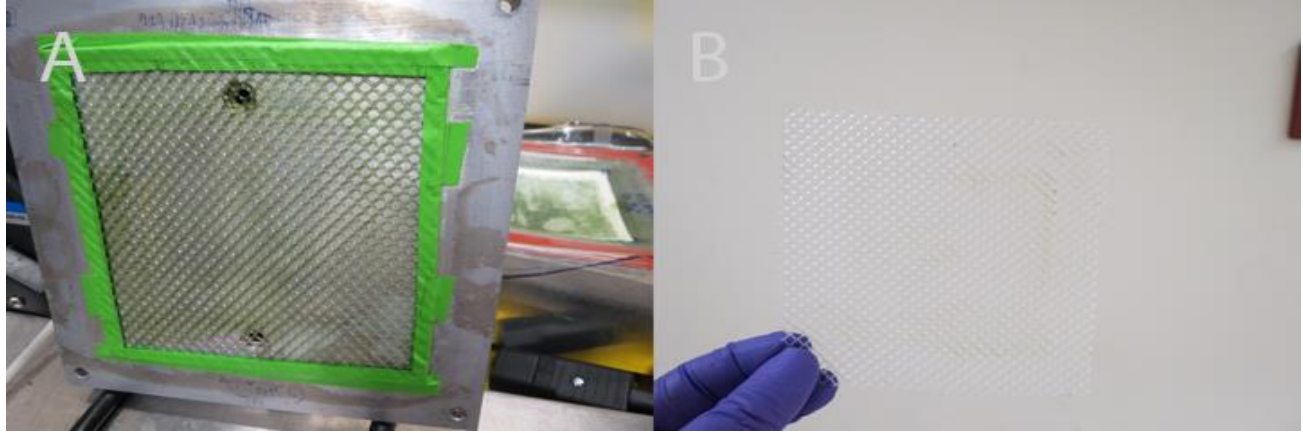

**Figure 11. Image of the external screen spacer of the BEB Evaporator showing the degree of membrane leakage for (A) first and (B) third runs.**

The chemical analysis of the feed and condensate are shown in Table 1. The first Hygiene Brine run (which was run in sequence with the three ISS Alternate Pretreatment brine runs), showed the same ion concentrations as the ISS Alternate Pretreatment brine runs. The second and third Hygiene Brine runs showed increased ion concentrations. Additionally, it was observed that the first few mL of condensate that was collected was highly discolored to a dark yellowish color. As the condensate collection continued, the discoloration of the condensate decreased. The discoloration of the condensate was barely noticeable by the end of the run. When pouring the condensate of the third run out of the collection cylinder, there was precipitate at the bottom of the cylinder. This precipitate was probably associated with the initial discoloration. It is postulated that during the time between the first and second Hygiene Brine runs that biological growth or chemical attack had happened within the tubing between the BEB System and the condensate collection.

The performance of the BEB System is shown in Table 6 and Table 7. The Hygiene Brine runs took substantially longer to dewater than the ISS Alternate Pretreatment brine runs. Therefore, the end point of the first run was not collected and was estimated using the ISS Alternate Pretreatment brine drying profile slowed to the Hygiene Brine's slower dewatering rate. For the second and third run, the end point was estimated and a data point was collected at that point and again the next morning for confirmation.

**Table 6. Raw data for the three Hygiene brine runs.**

Raw Data															
Run 1					Run 2					Run 3					
Time	Vol	Energy	Temp	Vac	Time	Vol	Energy	Temp	Vac	Time	Vol	Energy	Temp	Vac	
(Hrs)	(mL)	(kWhr)	( C )	(in Hg Vac)	(Hrs)	(mL)	(kWhr)	( C )	(in Hg Vac)	(Hrs)	(mL)	(kWhr)	( C )	(in Hg Vac)	
0.00	0	0.000	20.00	29.20	0	0	0.000	17	29.2	0	0	0	17	28.9	
0.22	1.00	0.123	57.00	29.40	0.45	1	0.252	72	28.1	0.25	0.1	0.156	57	29	
0.72	30.00	0.365	70.00	28.40	0.95	65	0.490	70	28.1	0.75	25	0.409	70	28	
1.72	90	0.796	70.00	28.7	1.45	100	0.702	70	28.5	1.25	55	0.628	70	29.1	
2.22	110	1.001	70.00	28.7	1.95	125	0.905	70	28.5	1.75	74	0.852	70	27.4	
2.72	130	1.202	70.00	28.7	2.45	150	1.106	70	28.5	2.25	100	1.053	70	28.3	
3.22	145	1.403	70.00	28.7	2.95	175	1.316	70	28.5	2.75	120	1.274	70	28.4	
3.72	160	1.602	70.00	28.7	3.45	195	1.518	70	28.5	3.25	135	1.479	70	28.4	
4.22	175	1.797	70.00	28.7	3.95	212	1.722	70	28.5	3.75	150	1.698	70	28.3	
4.72	185	1.995	70.00	28.8	4.45	230	1.925	70	28.5	4.25	165	1.913	70	28.4	
5.22	200	2.192	70.00	28.8	4.95	240	2.125	70	28.5	4.75	175	2.126	70	28.3	
5.72	210	2.390	70.00	28.8	5.45	250	2.323	70	28.6	5.25	185	2.34	70	28.3	
6.22	215	2.588	70.00	28.8	5.95	260	2.526	70	28.6	5.75	200	2.606	70	28.3	
6.72	225	2.782	70.00	28.8	6.45	265	2.725	70	28.6	6.25	207	2.767	70	28.3	
Estimated	13.00	303	5.132	70.00	29.6	6.95	270	2.927	70	28.6	6.75	220	3.019	70	28.9
	23.50	303	9.277	70.00	29.6	7.45	275	3.126	70	28.5	7.25	238	3.211	70	29.2
						12.12	297	5.127	70	29.6	11.75	285	5.185	70	29.4
						13.62	297				23.75	285			29.4
						20.42	296								

**Table 7. Calculated results for the three Hygiene brine runs.**

Calculated Results														
Run 1					Run 2					Run 3				
Median Time (Hrs)	Production Rate (mL/hr)	Cumulative Specific Power (kWhr/L)	Instantaneous Specific Power (kWhr/L)	Percent Water Recovery (%)	Median Time (Hrs)	Production Rate (mL/hr)	Cumulative Specific Power (kWhr/L)	Instantaneous Specific Power (kWhr/L)	Percent Water Recovery (%)	Median Time (Hrs)	Production Rate (mL/hr)	Cumulative Specific Power (kWhr/L)	Instantaneous Specific Power (kWhr/L)	Percent Water Recovery (%)
0.11	5	123.0	123.0	0.3	0.23	2	252.0	252.0	0.3	0.13	0	1560.0	1560.0	0.0
0.47	58	12.2	8.3	9.9	0.70	128	7.5	3.7	21.9	0.50	50	16.4	10.2	8.8
1.22	60	8.8	7.2	29.7	1.20	70	7.0	6.1	33.7	1.00	60	11.4	7.3	19.3
1.97	40	9.1	10.3	36.3	1.70	50	7.2	8.1	42.1	1.50	38	11.5	11.8	26.0
2.47	40	9.2	10.1	42.9	2.20	50	7.4	8.0	50.5	2.00	52	10.5	7.7	35.1
2.97	30	9.7	13.4	47.9	2.70	50	7.5	8.4	58.9	2.50	40	10.6	11.1	42.1
3.47	30	10.0	13.3	52.8	3.20	40	7.8	10.1	65.7	3.00	30	11.0	13.7	47.4
3.97	30	10.3	13.0	57.8	3.70	34	8.1	12.0	71.4	3.50	30	11.3	14.6	52.6
4.47	20	10.8	19.8	61.1	4.20	36	8.4	11.3	77.4	4.00	30	11.6	14.3	57.9
4.97	30	11.0	13.1	66.0	4.70	20	8.9	20.0	80.8	4.50	20	12.1	21.3	61.4
5.47	20	11.4	19.8	69.3	5.20	20	9.3	19.8	84.2	5.00	20	12.6	21.4	64.9
5.97	10	12.0	39.6	71.0	5.70	20	9.7	20.3	87.5	5.50	30	13.0	17.7	70.2
6.47	20	12.4	19.4	74.3	6.20	10	10.3	39.8	89.2	6.00	14	13.4	23.0	72.6
Estimated 9.86	12	16.9	30.1	100.0	6.70	10	10.8	40.4	90.9	6.50	26	13.7	19.4	77.2
15.11	5	30.6	83.3	100.0	7.20	10	11.4	39.8	92.6	7.00	36	13.5	10.7	83.5
					9.78	5	17.3	91.0	100.0	9.50	10	18.2	42.0	100.0

The BEB’s production rate rapidly increased over the first 30 minutes of a run as the system was heated to the operating temperature. As the brine dewatered, the production rate decreased with time until the brine was 100% dewatered 8 to 14 hours later (Figure 12). Figure 13 shows the cumulative water collection for each of the three runs. The final residue produced from the dewatering is a thick paste (Figure 5b).

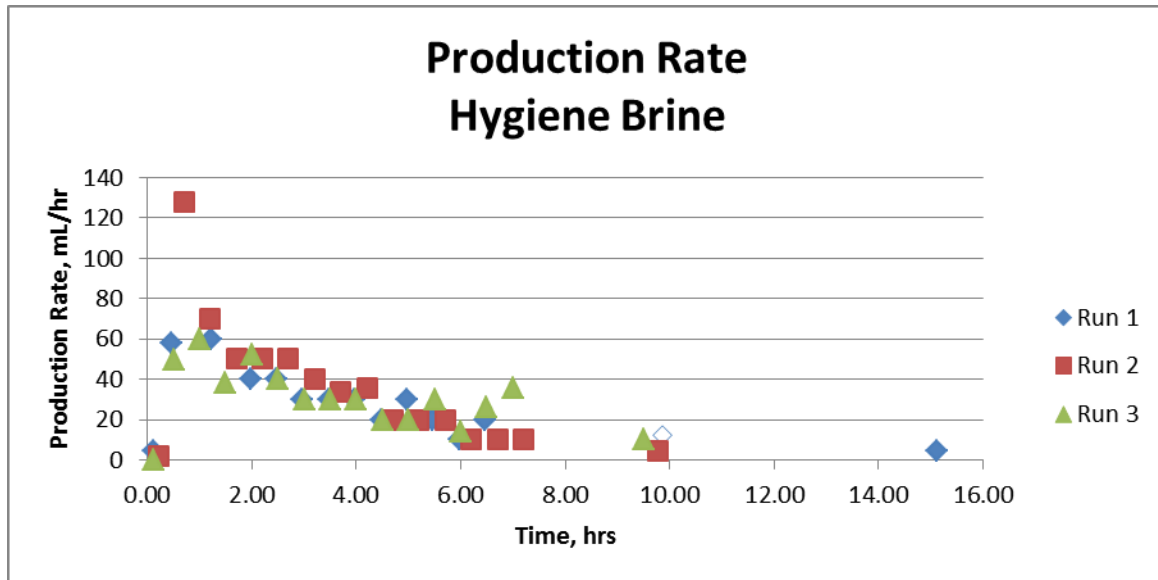

**Figure 12. Production rate for the three hygiene brine runs. The open diamond of the first run is the estimated end point for the run.**

It was determined that the brine was 100% dewatered when the vacuum of the system returned to the base pressure of nominally 29.4 in Hg vac. For the first Hygiene Brine run, the point of 100% dewatering was estimated based upon the dewater profile of the ISS Alternate Pretreatment brine (Table 7 above).

The BEB was operated to 100% water recovery of the Hygiene brine. However, the comparison testing only requires a water recovery of 84.4% for the Hygiene brine. Figure 14 shows the percent water recovery versus time. The BEB System dewatered 0.4L of Hygiene brine runs to 84.4% water recovery in 6.5 hr (std.dev. 1.4 hr) with a specific power of 11.5 kWhr/L (std.dev. 3.1 kWhr/L) (Figure 14). For the 4-crew, 360-day proposed mission, 770L of Hygiene brine would need to be processed. The as-tested BEB system would require 453 days (longer than the mission duration) to process the Hygiene brine. It would also require 195 bags.

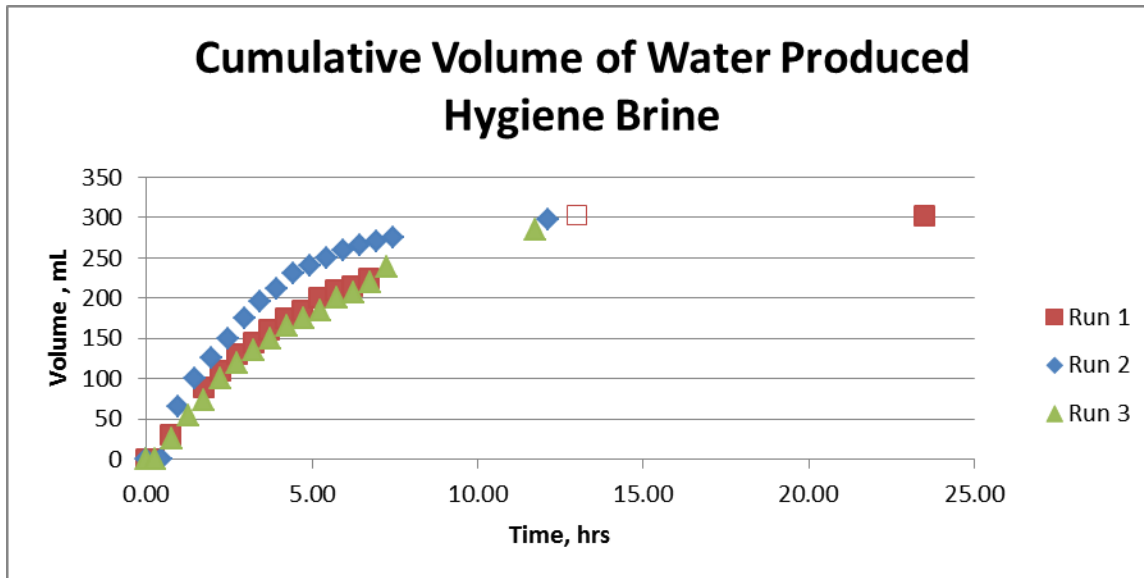

Figure 13. The cumulative volume of condensate collected for each of the three hygiene brine runs. The open square is the estimated end point for the first run.

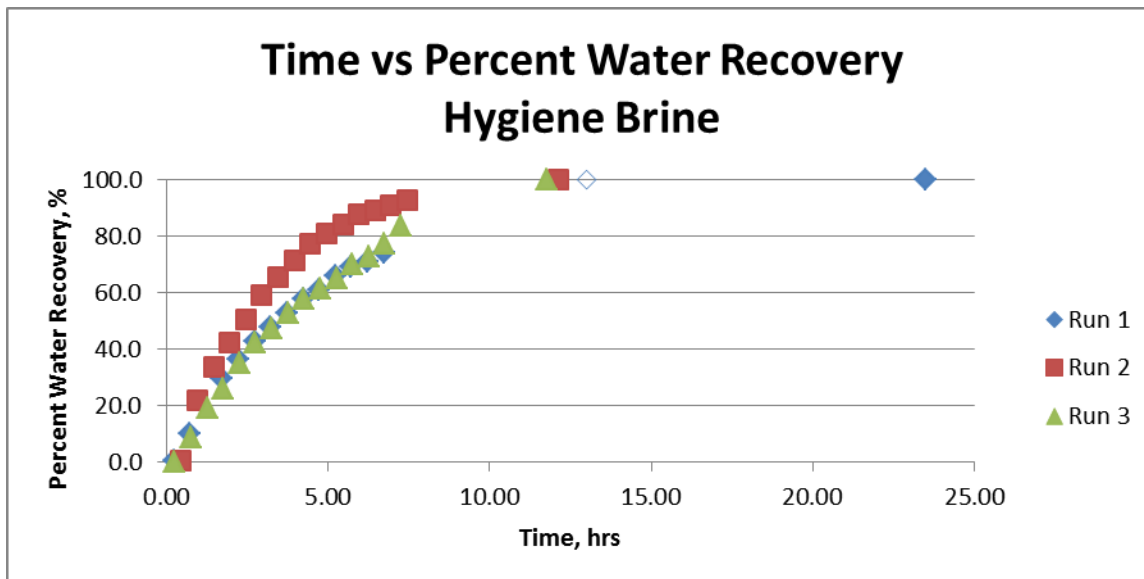

Figure 14. Plot showing the time required to reach a given water recovery.

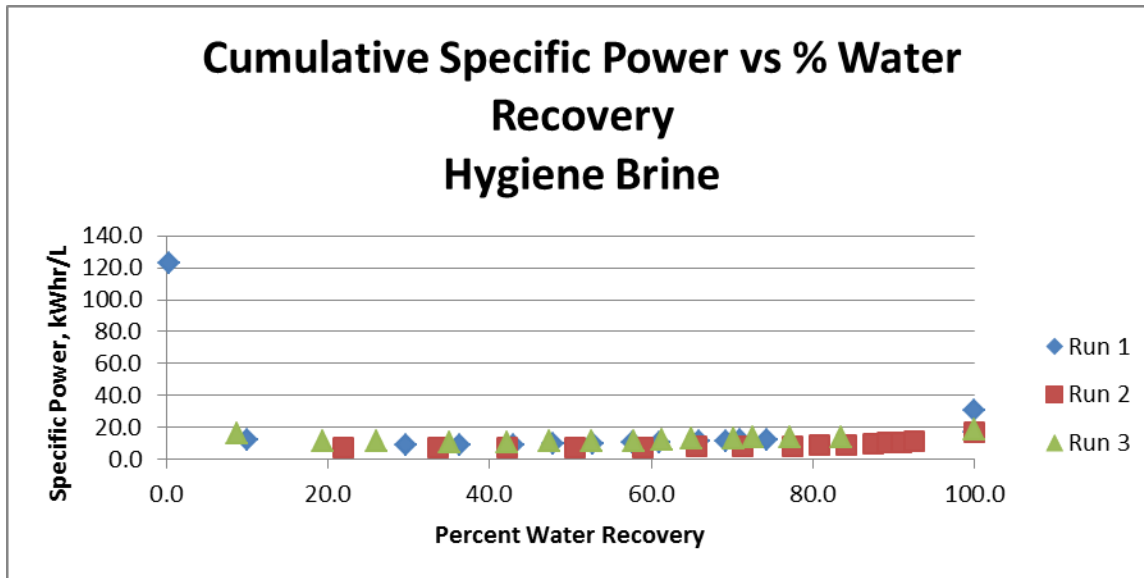

Figure 15. The graph shows the specific power that will be required for a run ending at the give percent water recovery. The initial high specific power is due to startup costs (the first point for runs 2 and 3 are not shown). The only slight increase at the end of the run is due to the averaging of the higher costs over the entire run.

It is postulated that the wetting of the membrane causes a plugging of the pores resulting in a decreased production rate. This is exemplified in Figure 16, which shows how the time required to reach a given percent water recovery for 3 cases of membrane area leakage.

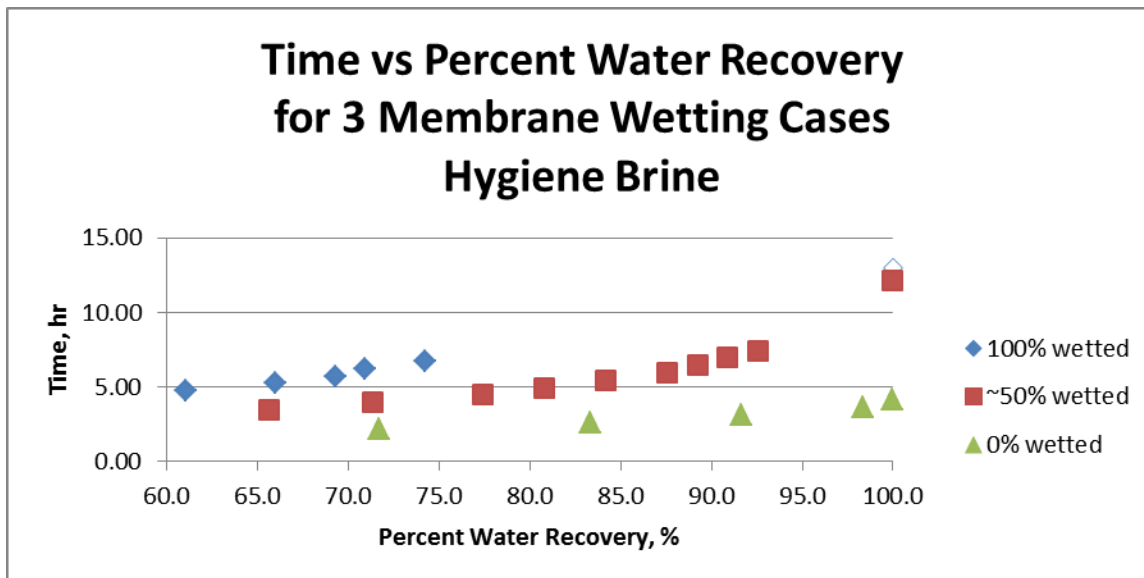

Figure 16. Plot showing the increase in processing time required as the membrane leakage increases.



## V. ESM Estimates

The ESM for the BEB is based upon the assumption that the BEB will need to process 899 kg of ISS Alternate Pretreatment brine to 86.7% water recovery and 770 kg of Hygiene brine to 84.4% water recovery. The average continuous power used was 0.48 kW for the ISS Alternate Pretreatment brine and 0.43 kW for the Hygiene brine. The mass of the BEB Evaporator, heaters, RTDs, and controllers is 6.3 kg. The mass of the Air Squared V16 scroll pump used is 6.4 kg. The BEB Evaporator measures 6" x 6" x 3" which gives 108 in<sup>3</sup> (0.002 m<sup>3</sup>). The Air Squared V16 scroll pump measures 7" x 7" x 14" which gives 686 in<sup>3</sup> (0.11 m<sup>3</sup>). An ESM estimate for a more ESM-optimized ISS Alternate Pretreatment brine at 100% water recovery will also be presented. The parameters for the calculation of the ESM for the ISS Alternate Pretreatment and Hygiene brines are presented in Table 8 and Table 9.

**Table 8. ESM Parameters for the as-tested BEB System at 86.7% water recovery from the ISS Alternate Pretreatment brine.**

<b>Mass (kg)</b>		<b>12.7 kg</b>
6.4	Vacuum pump	
6.3	BEB Evaporator, heaters, RTDs, controllers, and tubing	
<b>Power (kW)</b>	(0.48kW x 231/360 days running = 0.31KW average power)	<b>0.31 kW</b>
0.37 - 0.27 ca.	Vacuum pump (Total - Heaters)	
0.1 - 0.2 Est.	Heaters [Est. (5W/in <sup>2</sup> x 40in <sup>2</sup> = 200W) or (660Whr/L x 0.4L / 2.75hr = 96W)]	
<b>Cooling (kW)</b>	(0.48kW x 231/360 days running = 0.31KW average power)	<b>0.31 kW</b>
0.37 - 0.27 ca.	Vacuum pump (Total - Heaters)	
0.1 - 0.2 Est.	Heaters [Est. (5W/in <sup>2</sup> x 40in <sup>2</sup> = 200W) or (660Whr/L x 0.4L / 2.75hr = 96W)]	
<b>Volume (m<sup>3</sup>)</b>		<b>0.013 m<sup>3</sup></b>
0.011	Vacuum Pump	
0.002	BEB Evaporator	
<b>Consumables (kg)</b>		<b>11.7 kg</b>
11.7	BEB (0.06kg/bag x 195 bags/mission)	
<b>Crew Time (Hrs)</b>		<b>49 Hrs</b>
48.75	0.25 hrs to change bag x 195 bags/mission	

**Table 9. ESM Parameters for the as-tested BEB System at 84.4% water recovery from the Hygiene brine.**

<b>Mass (kg)</b>	(6.4 + 6.3 x 453/360 days running = 15.5 kg mass scaling)	<b>16 kg</b>
6.4	Vacuum pump	
6.3	BEB Evaporator, heaters, RTDs, controllers, and tubing	
<b>Power (kW)</b>	(0.43kW x 360/360 days running = 0.43kW average power)	<b>0.43 kW</b>
0.43	Average power usage - system scaled to run 360 days	
<b>Cooling (kW)</b>	(0.43kW x 360/360 days running = 0.43kW average power)	<b>0.43 kW</b>
0.43	Average power usage - system scaled to run 360 days	
<b>Volume (m<sup>3</sup>)</b>		<b>0.019 m<sup>3</sup></b>
0.011	Vacuum Pump	
0.008	BEB Evaporator - upscaled	
<b>Consumables (kg)</b>		<b>12.4 kg</b>
12.4	BEB (0.08kg/bag x 155 bags/mission) - fewer larger bags	
<b>Crew Time (Hrs)</b>		<b>38.75 Hrs</b>
38.75	0.25 hrs to change bag x 155 bags/mission	

The as-tested BEB System is not an optimized system. It could be further optimized by replacing the Air Squared V16 scroll pump with the Air Squared V11 scroll pump, which is much lighter and uses less power. Previous studies have shown that the V11 has difficulties below 60 °C, however, it works well at temperatures of 70 °C and above. With the limited NH<sub>3</sub> in the condensate, the BEB process can run at the higher temperatures allowing for the use of the lighter V11 scroll pump.

The BEB Evaporator is already small in size, so decreasing its size further would not significantly decrease its ESM. In fact, the smaller size would require more bags and change outs, so it would actually increase the ESM. Quadrupling the size of the BEB Evaporator (12" X 12" X 3") would greatly reduce the number of bags and change out required, and only slightly increase the mass, thus resulting in an ESM savings. For this optimized system (Table 10), the processing rate will be assumed to not increase as a conservative approximation. Even if the processing rate doubled, it would only result in about a 5 kg mass savings for power and cooling.

To obtain 100% dewatered ISS Alternate Pretreatment brine required an average of 4 hrs to process 0.4L. The ESM parameters for the 100% dewatered ISS Alternate Pretreatment brine for an optimized system is presented in Table 10.

**Table 10. ESM Parameters for an optimized BEB System processing ISS Alternate Pretreatment at 100% water recovery.**

<b>Mass (kg)</b>		<b>11.4 kg</b>
2.0	Air Squared V11 scroll pump	
9.4	BEB System increased 4x in size (12" x 12" x 3" w/ 1/4" walls)	

<b>Power (kW)</b>	(0.25kW x 195/360 days running = 0.09KW average power)	<b>0.13 W</b>
0.05	Air Squared V11 scroll pump	
0.2	Max Heater Output [Est. (5W/in <sup>2</sup> x 40in <sup>2</sup> = 200W) (Over estimate)	

<b>Cooling (kW)</b>	(0.25kW x 195/360 days running = 0.09KW average power)	<b>0.13 kW</b>
0.05	Air Squared V11 scroll pump	
0.2	Max Heater Output [Est. (5W/in <sup>2</sup> x 40in <sup>2</sup> = 200W) (Over estimate)	

<b>Volume (m<sup>3</sup>)</b>		<b>0.009 m<sup>3</sup></b>
0.001	Air Squared V11 scroll pump	
0.008	BEB Evaporator	

<b>Consumables (kg)</b>		<b>8.8 kg</b>
8.82	BEB (0.18kg/bag x 49 bags/mission)	

<b>Crew Time (Hrs)</b>		<b>12 Hrs</b>
12.25	0.25 hrs to change bag x 49 bags/mission	

The ESM for the three cases described above are presented in Table 11. The as-tested BEB System, processing ISS Alternate Pretreatment to 86.7% water recovery, would have an ESM of 77 kg. The ESM for the Hygiene brine would be 88 kg. This near invariance in the ESM is the net result of the increased size of the BEB Evaporator being offset by the reduction in the mass of the bags and the crew time ESM. Extending this mass savings even further (by quadrupling the size of the BEB Evaporator and replacing the pump) results in the optimized case where the ESM of the system is nearly reduced in half to 39 kg.

Table 11. ESM table for the three cases discussed.

<b>BEB System Configurations</b>						
		<b>As Tested</b>	<b>As Tested</b>	<b>Optimized</b>		
		<b>86.7%</b>	<b>84.4%</b>	<b>100%</b>		
		<b>Recovery</b>	<b>Recovery</b>	<b>Recovery</b>		
		<b>ISS Alt</b>	<b>Hygiene</b>	<b>ISS Alt</b>		
		<b>Pretreat</b>			<b>Pretreat</b>	
<b>Mass</b>	<b>Mass</b>	<b>(kg)</b>	24.4	28.4	20.2	
	<b>Factor</b>	<b>(kg/kg)</b>	1	1	1	
	<b>ESM Mass</b>	<b>(kg)</b>	<b>24.4</b>	<b>28.4</b>	<b>20.2</b>	
<b>Power</b>	<b>Power</b>	<b>(kW)</b>	0.31	0.43	0.13	
	<b>Factor</b>	<b>(kg/kW)</b>	23	23	23	
	<b>ESM Mass</b>	<b>(kg)</b>	<b>7.13</b>	<b>9.89</b>	<b>2.99</b>	
<b>Cooling</b>	<b>Cooling</b>	<b>(kW)</b>	0.31	0.43	0.13	
	<b>Factor</b>	<b>(kg/kW)</b>	60	60	60	
	<b>ESM Mass</b>	<b>(kg)</b>	<b>18.6</b>	<b>25.8</b>	<b>7.8</b>	
<b>Volume</b>	<b>Volume</b>	<b>(m<sup>3</sup>)</b>	0.013	0.019	0.009	
	<b>Factor</b>	<b>(kg/m<sup>3</sup>)</b>	216	216	216	
	<b>ESM Mass</b>	<b>(kg)</b>	<b>2.808</b>	<b>4.104</b>	<b>1.944</b>	
<b>Crew Time</b>	<b>Crew Time</b>	<b>(Hrs)</b>	49	39	12	
	<b>Factor</b>	<b>(kg/Hr)</b>	0.5	0.5	0.5	
	<b>ESM Mass</b>	<b>(kg)</b>	<b>24.5</b>	<b>19.5</b>	<b>6</b>	
<b>System</b>						
	<b>ESM</b>	<b>(kg)</b>	<b>77.438</b>	<b>87.694</b>	<b>38.934</b>	

An optimized and integrated BEB System could be vented back into the UPA such that no vacuum pump, condenser or trace contaminant control would be required. However, for completeness, if the BEB System was vented into the cabin, then it would only add 14 kg of ESM to the BEB System (Equation 1). The ESM for the Common Cabin Air Assembly (condenser) and the Trace Contaminant Control System (TCCS) are 135 kg and 95 kg, respectively. The BEB System is over sized, requiring only 231 out of 360 days of use. The BEB System is also only processing the brine to 86.7% water recovery. Finally, the Common Cabin Air Assembly currently processes 2.227L of humidity condensate per person per day. The amount of water added to this process would be the volume of urine wastewater produced times the percentage of water remaining in the brine times the percent water recovery from the brine.

Added ESM for TCCS and condenser if vented into cabin

$$\begin{aligned}
 &= \frac{\text{Vol. Brine to H.C. per cycle}}{\text{Vol. H.C. per cycle}} \times \frac{\text{days of operation}}{\text{days of mission}} \times \text{Condenser ESM} \\
 &= \frac{4.163 \text{ L Feed/CM} \times (1 - 0.85) \times 0.867}{2.27 \text{ L H.C./CM condensate}} \times \frac{4 \text{ mission crew}}{6 \text{ ISS crew}} \times \frac{231 \text{ mission use}}{360 \text{ mission length}} \times 135 \text{ kg} \\
 &= 14 \text{ kg} \qquad \qquad \qquad \text{Equation 1}
 \end{aligned}$$

If the BEB System is required to have its own condenser-separator, it could use a condenser-separator similar to flight qualified condenser-separator already on the ISS that has an ESM of 17 kg. This would allow for the condensate to be sent directly back to the UPA system for processing.

The TCCS would only be processing the 0.1 L/min purge of the BEB System which has been shown to be ultra-low in contaminants by the GCMS analysis. The GCMS would estimate the contaminants to be on the ultra-low ppb level if not non-detectable. The reason for this ultra-low contamination is first due to the ultra-low air flow through the BEB Evaporator, and second, as the water is condensed, so are the contaminants. Thus the condenser is acting as a scrubber for the effluent gas. Looking at the TOC levels for the condensates, it is observed that the ISS Alternate Pretreatment condensate produced 192 ug/ml (std. dev 8.7). Thus, a days' worth of processed brine would produce a total organic load of 0.41 g/day (Equation 2), or a TOC level, within the ISS (900m<sup>3</sup>), of less than 0.46 ppb (Equation 3) within the cabin. The GCMS analysis for the IWP and UBDS identified nearly 200 chemicals.<sup>5</sup> Thus, dividing the 0.46 ppb of organics between these 200 chemicals would result in any given chemical's concentration being much less than 0.46 ppb (part per billion).

$$\frac{899 \text{ kg}}{360 \text{ day}} \times \frac{1000 \text{ g}}{1 \text{ kg}} \times \frac{1}{1.15 \text{ g/mL}} \times \frac{192 \text{ ug/mL}}{1,000,000 \text{ ug/g}} = <0.41 \text{ g/day} \qquad \text{Equation 2}$$

$$<0.41 \text{ g/day} \times \frac{1 \text{e6 ug/g}}{900 \text{m}^3 \times 1 \text{e6 mL/m}^3} = <0.00046 \text{ ug/mL} = <0.46 \text{ ppb} \qquad \text{Equation 3}$$

Alternatively, the contaminant load that would be expected within node 3 if the BEB System was running within node 3 would be less than 7 ppb. The 7 ppb is based upon the reported air recycle rate is between 0.42 and 5.1 m<sup>3</sup>/min, and the BEB System has an average brine production rate of 1.25 mL/min.

## VI. Future Work

Future work for the BEB System will include several areas of development including, ion-channel membrane development, large BEB Evaporator, scaling requirements, ESM trade-offs, and a continuous-feed BEB Evaporator.

Hydrophobic pervaporation membranes are susceptible to surfactant fouling. Ion-channel PTFE membrane, however, are not. The ion channel is only 10s of nanometers in diameter and is lined by negatively charged moieties. The negative charge of the channel repels the negative charge of the surfactant molecules preventing it from entering and fouling the channel as in pervaporation membranes. The welding of the ion-channel membrane into the film will need development.

Increasing the physical size of the BEB Evaporator will slightly increase the mass of the system, however, it could be more then off-set by the ESM saving in resupply and crew time requirements. Additionally, studying two BEB Evaporators of differing sizes will allow for determination of the scaling factors for the system, i.e., does the production rate scale with membrane area, or does it scale with heat transfer (vacuum and temperature) for the system.

The as-tested BEB System was a batch system. The future plan is to develop the BEB System as a continuous feed system. Initial work had been done in this area, however, much more work is required.

## VII. Conclusions

The BEB System demonstrated the ability to process ISS Alternate Pretreatment brine without leaking Cr(VI). The Cr(VI) analysis by Accutest Laboratories, showed that the BEB's Cr(VI) concentration was less than their detection limit.

The hydrophobic ePTFE membrane is susceptible to surfactant fouling. However, an ion-channel ePTFE membrane (such as Nafion) is not susceptible to surfactant fouling. Nafion membrane permeability rates are affected by the ions of the solution it is in contact with. However, this is simply a production rate and sizing issue, and it has already been demonstrated that increasing the size of the BEB Evaporator will actually reduce its ESM (due to the bag and crewtime off-setting factors).

The BEB has demonstrated the ability to process both the ISS Alternate Pretreatment and Hygiene brines to the specified water recovery rates. In fact, the BEB processed both to 98% water recovery from the feed brine.

For the ISS Alternate Pretreatment brine, the BEB has a low ESM (77 kg). An optimized BEB System could reduce the as-tested ESM by approx. 50% to a mere 39 kg (this ESM also includes the estimated crew time ESM).

The as-tested BEB System has two levels of containment. Additionally, they are dissimilar containment systems (plastic bag and metal box) so that a failure mechanism of one layer would most likely not cause a failure of the second layer, i.e., a sharp object would not be able to puncture both layers of containment.

The BEB System can be vented directly back into the VCD of the UPA system or directly to the subsequent polishing step. This has two benefits. First, it eliminates any concern for releasing volatiles into the cabin, and second it will eliminate the need to reprocess a condensed liquid further saving ESM. Although the BEB System was operated with a small purge gas flow rate for this test, a purge gas is not required. It was only used due to the effluent gas collection requirement for GCMS analysis.

Connecting the BEB to the UPA would also reduce the total ESM for the entire system in that the UPA would be providing vacuum to the BEB eliminating the pump and much of the power and cooling requirements of reprocessing the condensate.

## Acknowledgments

This research was support by the AES Brine Project.

## References

- <sup>1</sup>Lance Delzeit, John Fisher, and Alex Polonsky, "Brine pH Change Resulting from Urea Hydrolysis and Implication to Brine Dewatering", 41st International Conference on Environmental Systems, 2011.
- <sup>2</sup>Lance Delzeit, John W. Fisher, Greg Pace, and Hali Shaw, "Brine Evaporation Bag Design Concept and Initial Test Results", 42nd International Conference on Environmental Systems, 2012.
- <sup>3</sup>Lance Delzeit, John Fisher, Greg Pace, Eric Gollhofer, "Microgravity Behavior of Water within the Brine Evaporation Bag", 43rd International Conference on Environmental Systems, 2013.
- <sup>4</sup>Lance Delzeit, John Fisher, Michael Flynn, Kevin Howard, Hali Shaw, and Deirdre Hyde, "Continued Development of the Brine Evaporation Bag", 44th International Conference on Environmental Systems, 2014.
- <sup>5</sup>Kelsey, *et al.*, "Ionomer-membrane Water Processor (IWP) Engineering Development Unit (EDU)", ICES-2015-124, Proceedings of the 45th International Conference on Environmental Systems, July 2015.
- <sup>6</sup>Akse, J., Holtsnider, J., Wheeler, R. Fisher, J., "Brine Dewatering Using Ultrasonic Nebulization" SAE Paper No. 2004-01-2448, *Proceedings of the 34th International Conference on Environmental Systems*, 2004.
- <sup>7</sup>Michael T. Flynn, *et al.*, "Microgravity Testing of the Forward Osmosis Bag (FOB), A Personal Water Purification Device", AIAA 2013-3472, 43rd International Conference on Environmental Systems, 2013.
- <sup>8</sup>Shaw, H., Flynn, M., Wisniewski, R. Delzeit, L., Lee, J., Jones, H., Shull, S., Sargusingh, M., Beeler, D., Howard, J., Howard, K., Kawashima, B., Parodi, J., "Evaluation of Selected Brine Processing Technologies for Spacecraft Wastewater", Paper No. ICES-2015-202, Proceedings of the 45th International Conference on Environmental Systems, July 2015.
- <sup>9</sup>Lance Delzeit and Michael Flynn, "Results and Interpretation of the WFRD ELS Distillation Down-Select Test Data", 40th International Conference on Environmental Systems, 2010.