

# Fiber Optic Sensing System (FOSS) Technology





*A New Sensor Paradigm for Comprehensive Structural  
Monitoring and Model Validation throughout the Vehicle  
Life-Cycle*

**Francisco Peña, Dr. Lance Richards, Allen. R. Parker, Jr.,  
Anthony Piazza, Patrick Chan, and Phil Hamory**

NASA Armstrong Flight Research Center  
Edwards, CA

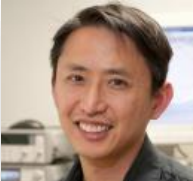
January 20<sup>th</sup>, 2015

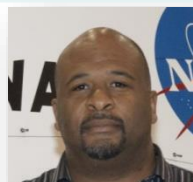
# The FOSS Team

	Team member	Field	Contributions to FOSS
	<b>Patrick Chan</b>	Optics Engineer	Optics Development, laser research and development
	<b>Philip Hamory</b>	Electrical Engineer	Advanced System Algorithm Development
	<b>Francisco Pena</b>	Structures Engineer	Structural Test and Analysis
	<b>Allen Parker</b>	Electrical Engineer	Systems design & development, data processing and visualization
	<b>Anthony Piazza</b>	Instrumentation Specialist	Sensor characterization, application, & interpretation
	<b>Lance Richards</b>	Structures Engineer	Aircraft structures, strain measurement research

# AFRC Structures Test and Analysis

## Structural Test and Analysis Products

- Experimental methods
  - Structural testing from coupon, subcomponent, component, qual-unit, flight component, full vehicle (for aircraft of all Mach no's, launch vehicles, spacecraft applications)
  - Ground testing (structural labs, wind tunnels, cryogenic labs)
  - Flight testing
  - Mechanical: Load frames, custom designed test setups, load introduction hardware, restraints,
  - Thermal: high & low temperature (radiant quartz lamps and cryogenic cooling, resp)
  - Aero
- Structural measurement methods
  - Strain (stress), temperature, displacement, load, heat flux, discrete, full-field
  - Strain gage technology, fiber optic sensors, load cells, LVDTs, potentiometers, TCs, digital image correlation, thermal imaging, Interferometry, Moire,
  - Experimental Stress Analysis, measurement uncertainty (temperature compensation methods)
  - Correlation of experimental / analytical results
  - Collaborate with analysts to correlate experimental results with analytical predictions
- Analytical, computational, empirical
  - Pre-test, pre-flight predictions
  - Validated structural analysis from coupon, subcomponent, component, qual-unit, flight component, full vehicle (for aircraft of all Mach no's, launch vehicles, spacecraft applications)
  - Collaborate with experimentalists to correlate real-time structural monitoring (comparison of structural performance vs analytical predictions)
  - Post-test, post flight, correlation of analytical/experimental results
    - Tuning of B/Cs, mat props, loads (mech/thermal, i.e applying measured data to analysis models)

# NASA Focused Structural Health Monitoring

## Key Drivers

Vehicle-focused  
Real-time,  
decision-making  
Online processing  
Onboard systems  
Lightweight,  
Small size,  
Low power,  
System solutions

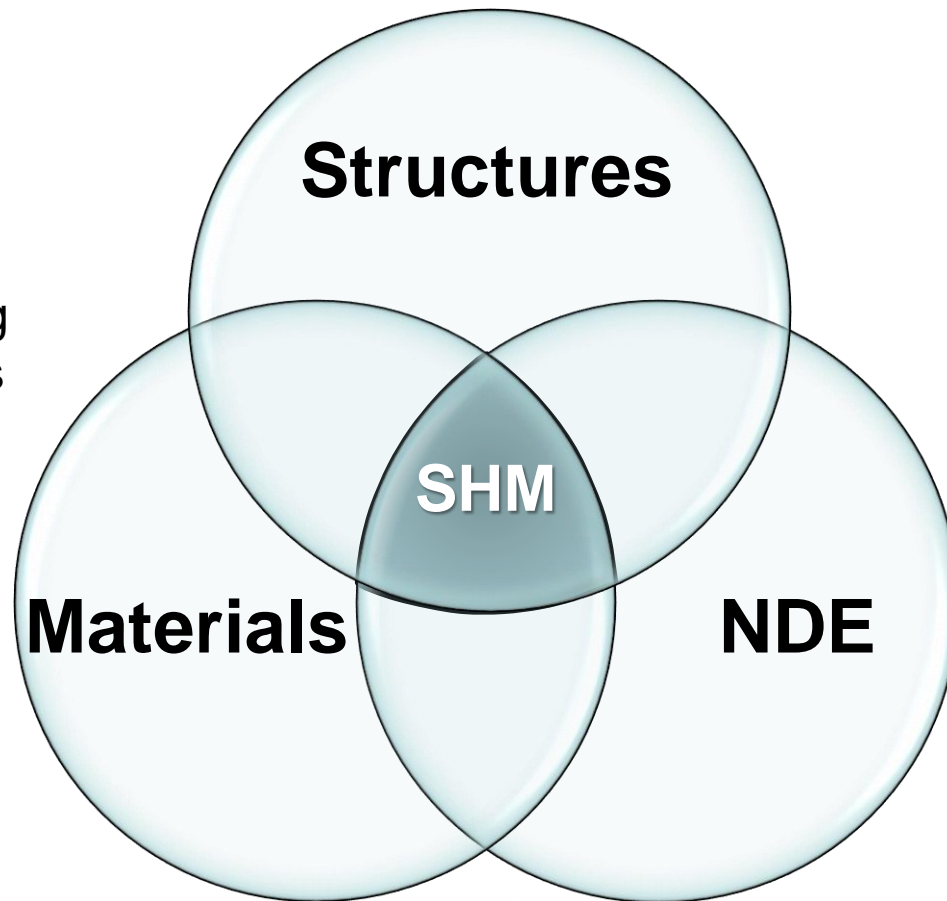

## Enabling Technologies

Advanced Sensing  
- Multi-parameter  
- Sensor arrays  
Advanced Systems  
and Processing  
- Solid state  
- Rugged  
- High Speed  
Ultra-Efficient  
Algorithms



# Background and Inspiration

## Biological Inspiration of Fiber Optic Smart Structures

### One Square-Inch of Human Skin

- Four yards of nerve fibers
- 600 pain sensors
- 1300 nerve cells
- 9000 nerve endings
- 36 heat sensors
- 75 pressure sensors
- 100 sweat glands
- 3 million cells
- 3 yards of blood vessels

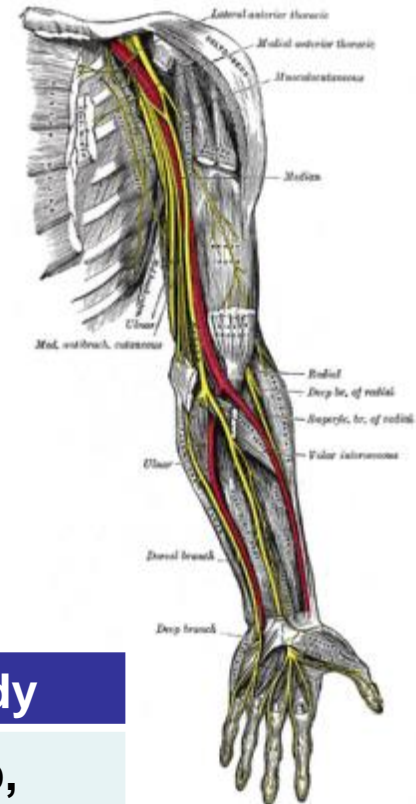
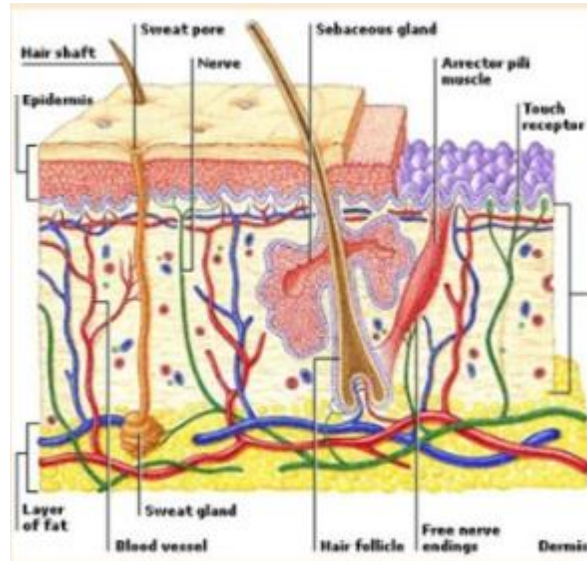

Smart Structure	Human Body
Fiber Optic Sensors	Pain, temp, pressure sensors
Piezo's, SMAs	Muscles
IVHM, Smart Systems	Brain

# Why Fiber Optic Sensors?

## One Of These Things (is Not Like The Others)

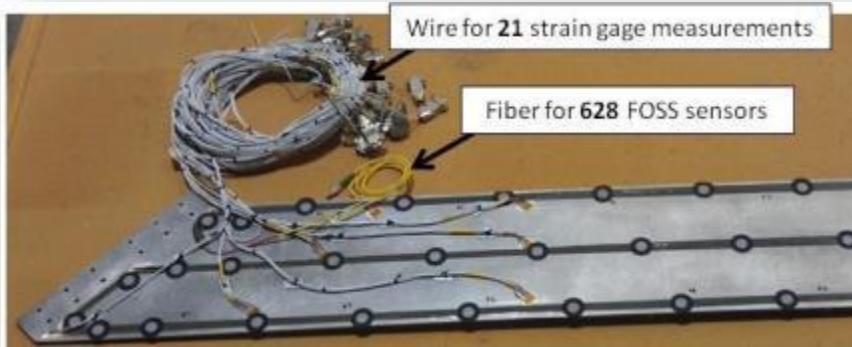

**(Heavy)**

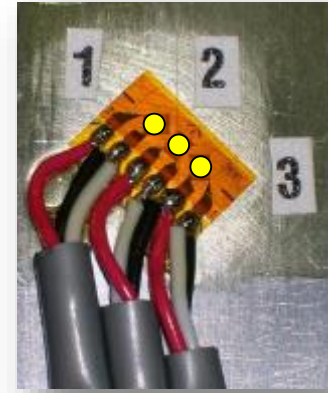

**(Big)**



**(Complex)**

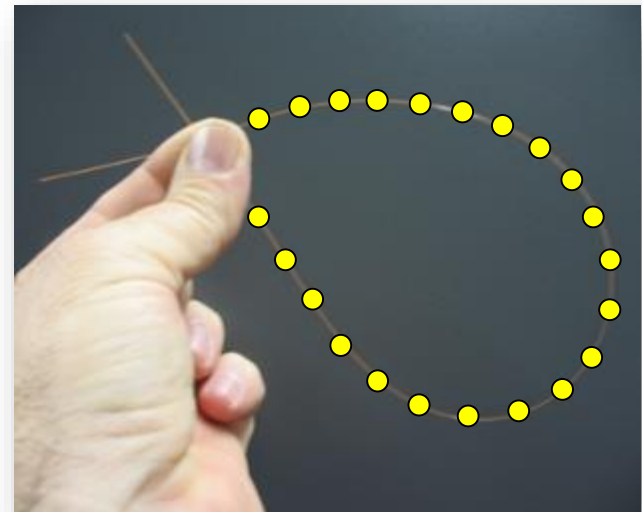

**(Light, small, easy)**

# Fiber Optic System Operation Overview

## Fiber Optic Sensing with Fiber Bragg Gratings

- Immune to electromagnetic / radio-frequency interference and radiation
- Lightweight fiber-optic sensing approach having the potential of embedment into structures
- Multiplex 100s of sensors onto one optical fiber
- Fiber gratings are written at the same wavelength
- Uses a narrowband wavelength tunable laser source to interrogate sensors
- Typically easier to install than conventional strain sensors
- In addition to measuring strain and temperature these sensors can be use to determine shape

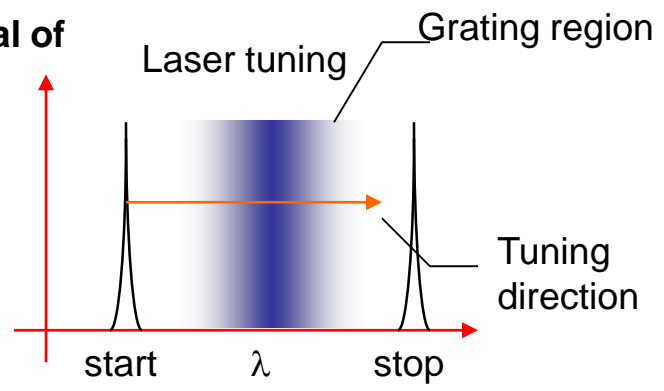

$$I_R = \sum_i R_i \cos(k2nL_i) \quad k = \frac{2\pi}{\lambda}$$

$R_i$  – spectrum of  $i^{\text{th}}$  grating  
 $n$  – effective index  
 $L$  – path difference  
 $k$  – wavenumber

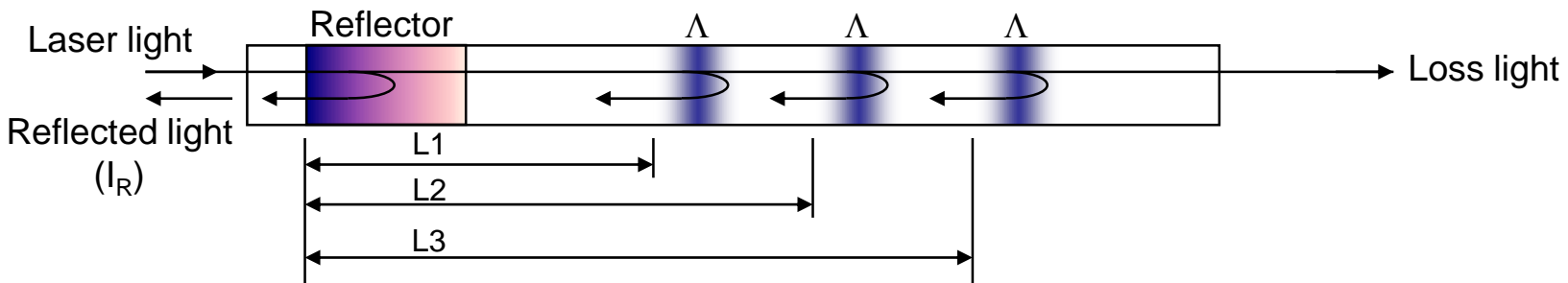

# How it Works: FBG OFDR Overview

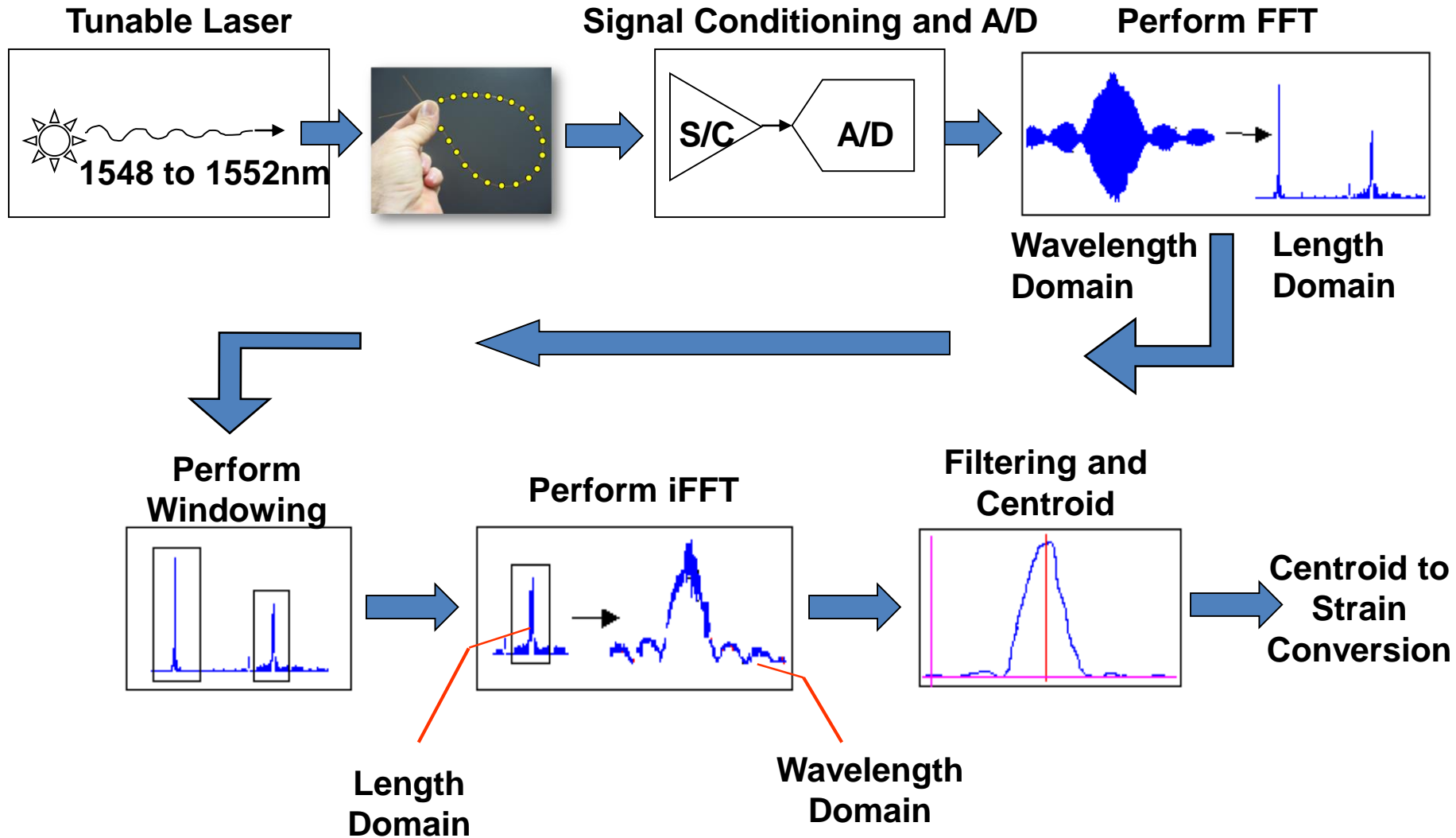



# Armstrong's FOSS Technology

## Current Capabilities

### Current system specifications

- Fiber count 16
- Max sensing length / fiber 40 ft
- Max sensors / fiber 2000
- Total sensors / system 32000
- **Max sample rate (flight) 100 sps**
- **Max sample rate (ground) 60 sps**
- Power (flight) 28VDC @ 4.5 Amps
- Power (ground) 110 VAC
- User Interface Ethernet
- Weight (flight, non-optimized) 27 lbs
- Weight (ground, non-optimized) 20 lbs
- Size (flight, non-optimized) 7.5 x 13 x 13 in
- Size (ground, non-optimized) 7 x 12 x 11 in

### Environmental qualification specifications for flight system

- Shock 8g
- Vibration 1.1 g-peak sinusoidal curve
- Altitude 60kft at -56C for 60 min
- Temperature  $-56 < T < 40C$



Flight System



Ground System



Predator -B in Flight

# Fiber Bragg Grating (FBG)

## Optical Frequency Domain Reflectometry (OFDR)

**FBG-OFDR can dramatically improve structural and system efficiency for space vehicle applications by improving both affordability and capability by ...**

- Providing >100x the number measurements at 1/100 the total sensor weight
- Providing validated structural design data that enables future launch systems to be lighter and more structurally efficient
- Reducing data system integration time and cost by utilizing a single small system for space / launch vehicles
- Increasing capability of measuring multiple parameters in real time (strain, temp., accel, liquid level, shape, applied loads, stress, mode shapes, natural frequencies, buckling modes, etc.)
- Providing an unprecedented understanding about system/structural performance throughout space craft and mission life cycle

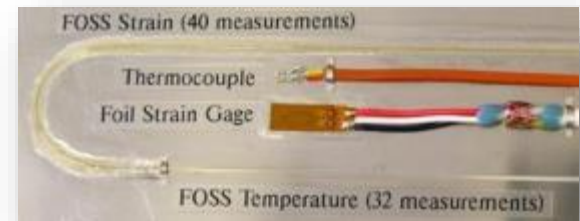

Metallic Coupon



Pressure monitoring



Liquid level sensing



ISS COPV strain & temp monitoring

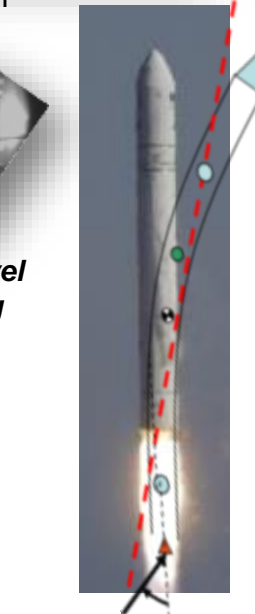
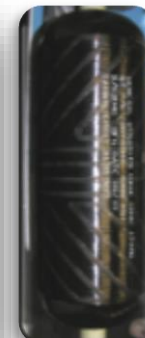

Shape sensing for vehicle control

# FOSS Advantages to Conventional Strain Measurements

- Unrivaled spatial density of sensors for full-field measurements
- Measurements immune to EMI, RFI and radiation
- Lightweight sensors
  - Typical installation is 0.1 - 1% the weight of conventional gage installations (based on past trade studies)
  - 1000's of sensors on a single fiber (up to 80 feet per fiber)
  - No copper wires
- With uniquely developed algorithms, these sensors can determine deformed shape and loads at points along the fiber for *real-time* feedback
- Great in high strain and fatigue environments
- Small fiber diameter
  - Approximately the diameter of a human hair
  - Unobtrusive installation
  - Fibers can be bonded externally or applied as a 'Smart Layer' top ply
- Single calibration value for an entire lot of fiber
- Wide temperature range
  - Cryogenic up to 500°F
  - Very linear thermal compensation

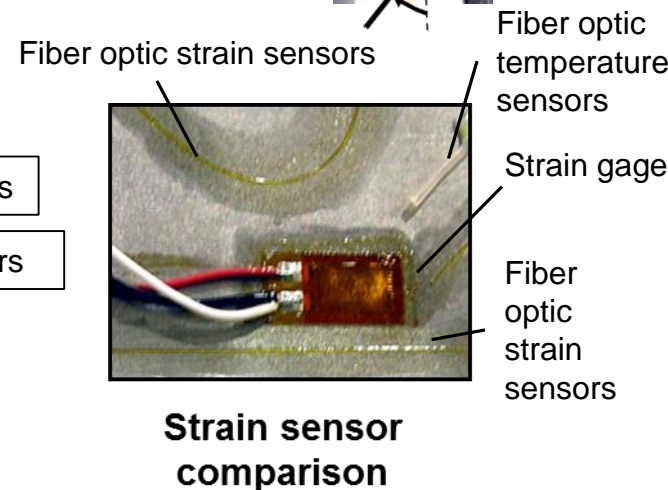
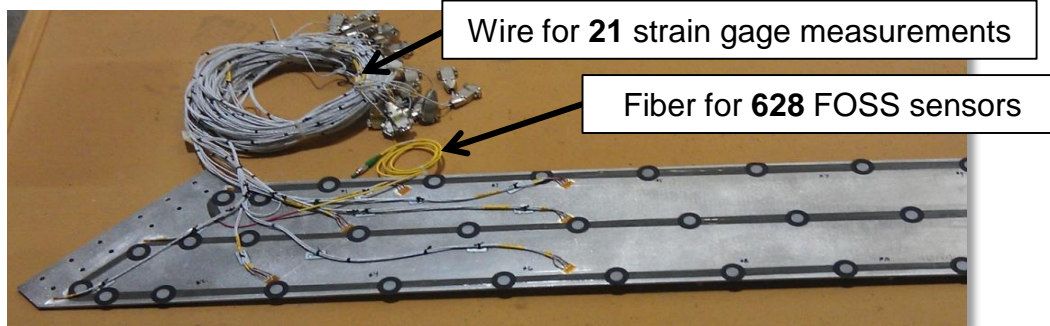
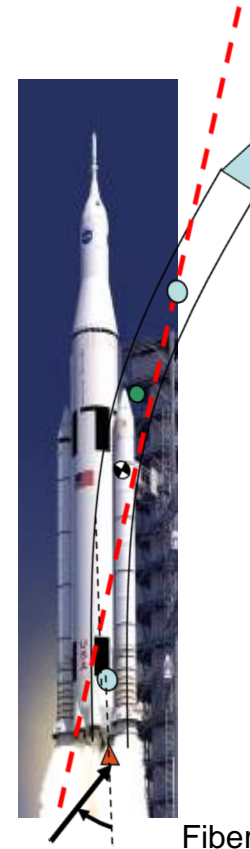

# FOSS Sensor Technology Comparison

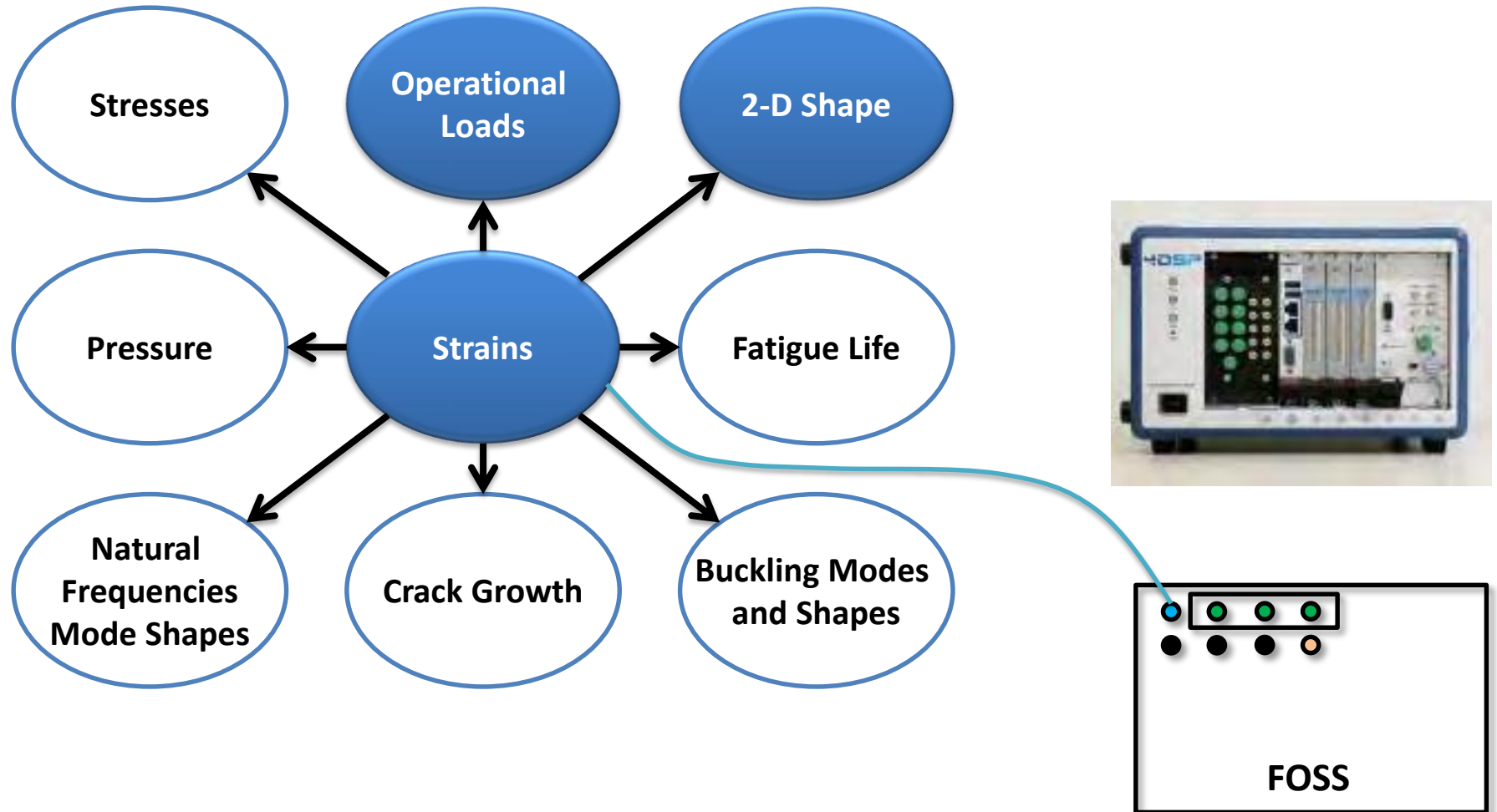

# Fiber Optic Sensing Applications

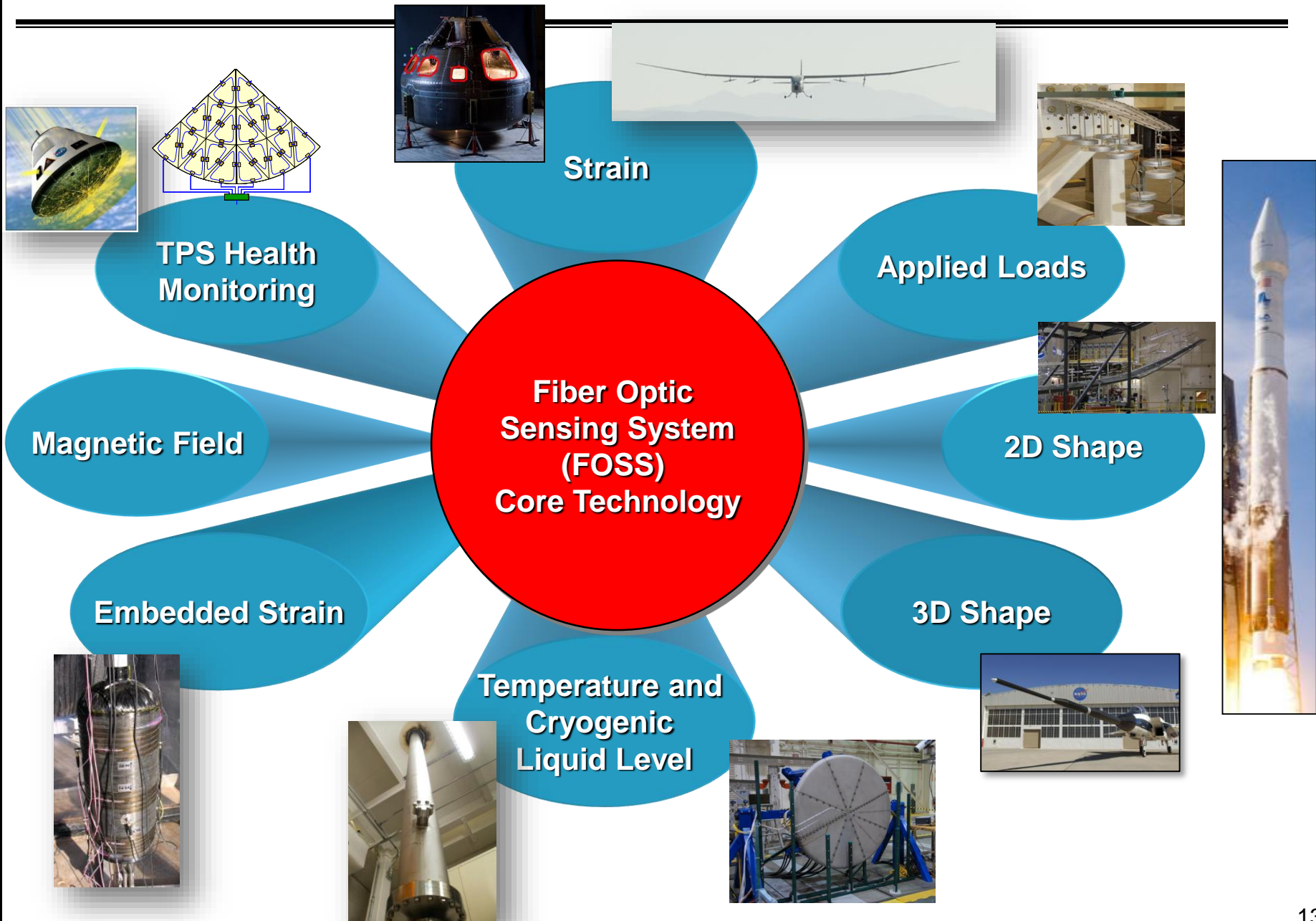

---

# Strain Sensing Applications

# Composite Overwrapped Pressure Vessel (COPV) Sensor Mapping – Surface Mounted Fiber

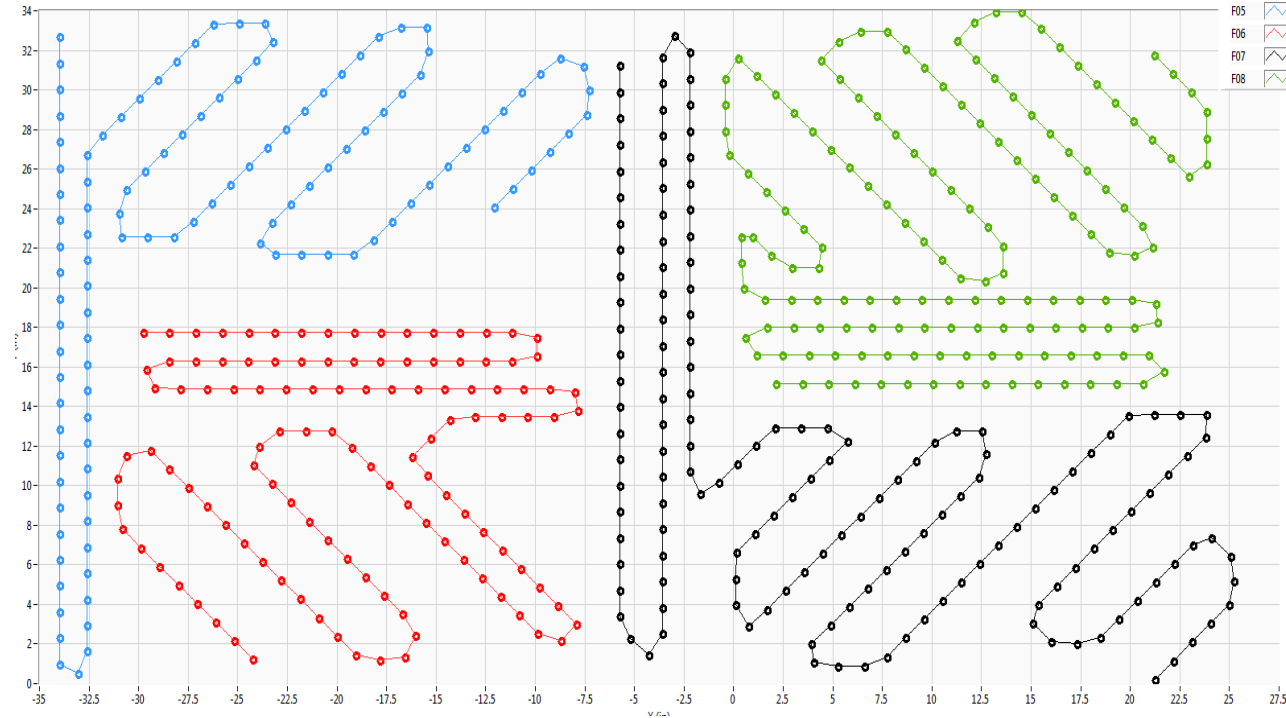
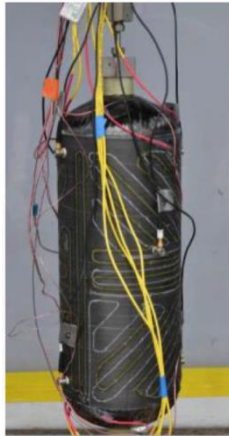
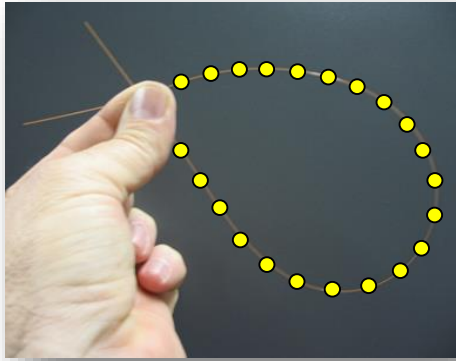

530 Surface strain measurements



# COPV Stiffness / Pressure Monitoring, Individual Sensor

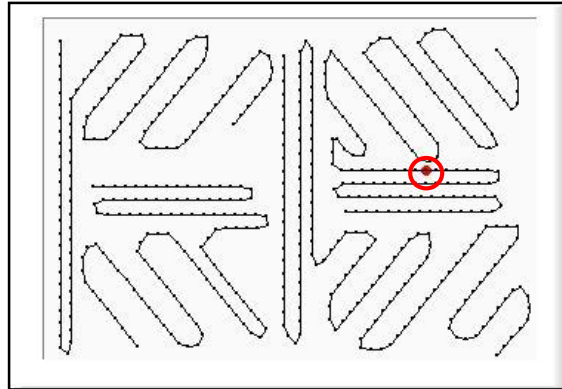

$$\frac{\epsilon_i}{P} = \left( \frac{D}{n_i t} \right) \cdot \left( \frac{1}{E_i} \right)$$

**Fiber line #8, FBG #97,  
Micro-strain & Pressure (psi) Vs. Time**

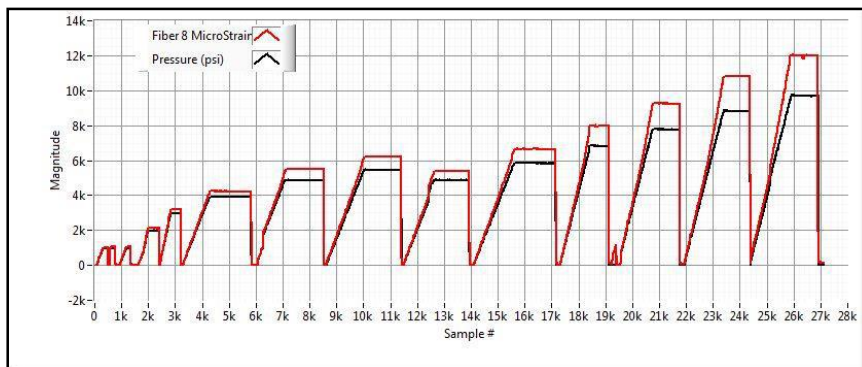

**Fiber line #8, FBG #97,  
Micro-strain Vs. Pressure (psi)**

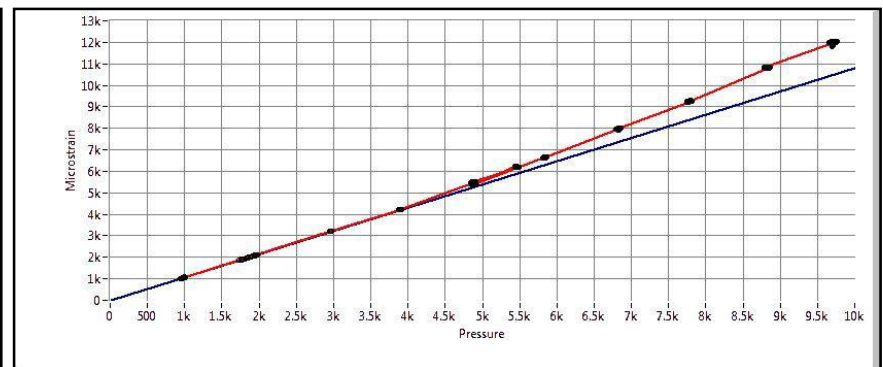

Pena, F., Strutner, S., Richards, W. L., Piazza, A., Parker, A. R. "Evaluatin of Embedded FBGs in Composite Overwrapped Pressure Vessels for Strain Based Structural Health Monitoring", Proc. SPIE 2014-9059



# COPV Stiffness / Pressure Monitoring

- Expands previous studies performed by the Armstrong NNWG on the structural health monitoring techniques
- Implementation of real-time finite-element-like fringe plots
- Further studies into stiffness/pressure monitoring as SHM parameter

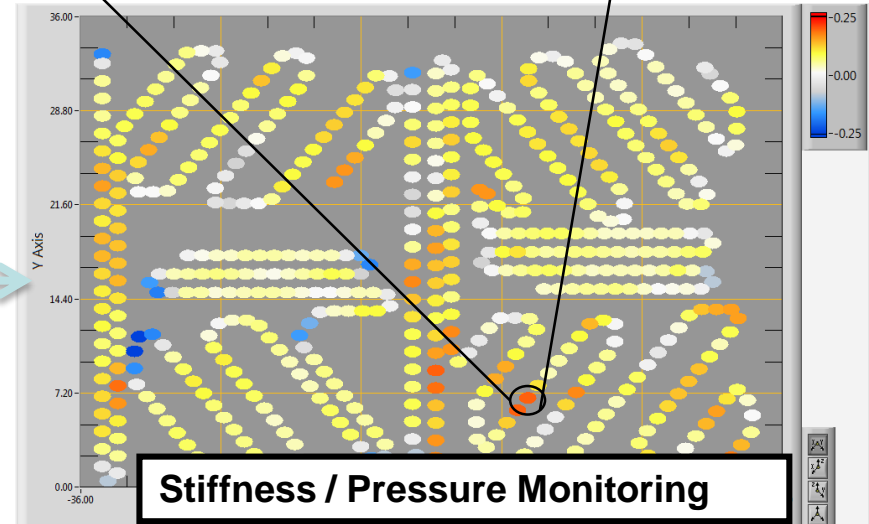
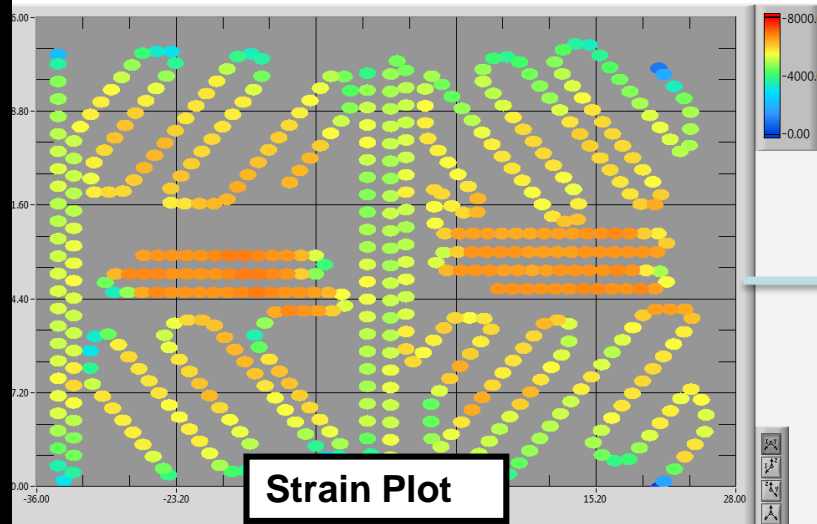
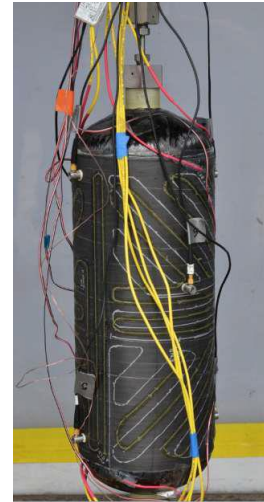
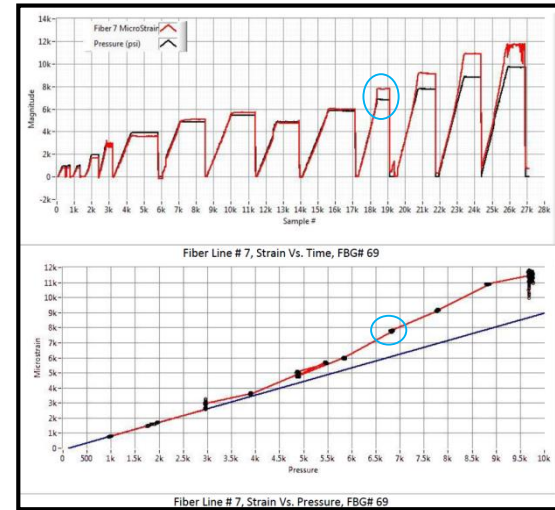

Pena, F., Strutner, S., Richards, W. L., Piazza, A., Parker, A. R. "Evaluatin of Embedded FBGs in Composite Overwrapped Pressure Vessels for Strain Based Structural Health Monitoring", Proc. SPIE 2014-9059

# Simulated Shield MMOD Testing with Fiber Optic Sensors

Utilize Fiber Optic Sensors on a simulated MMOD shield structure to monitor the response to hypervelocity impacts

Use Fiber Optic Sensors to determine:

1. If an impact occurred
2. When did the event occur
3. Where did the impact occur
4. Quantify Damage

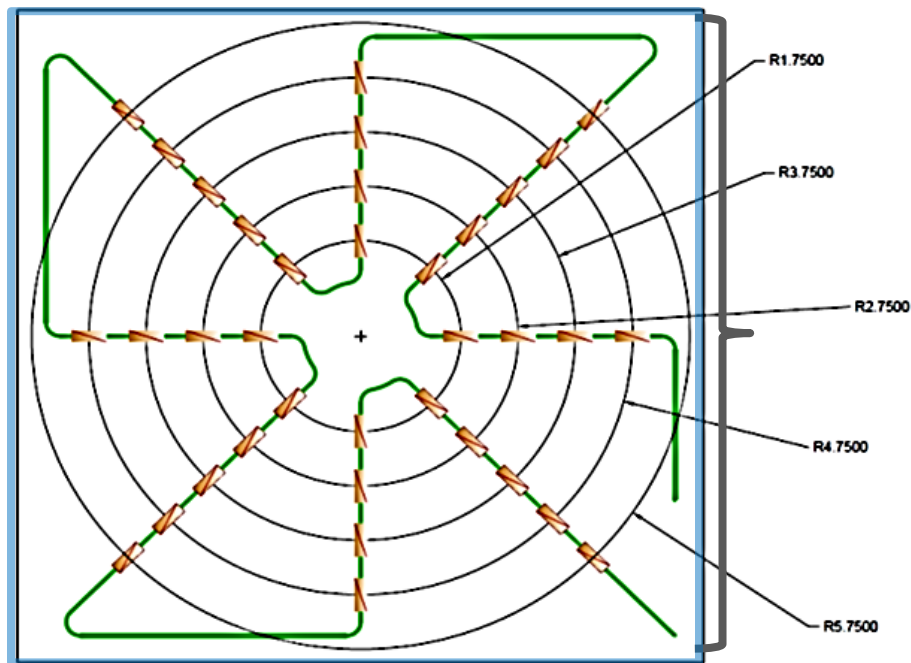

**Fiber Optic Routing and Location of Sensors  
(as seen from back of plate)**

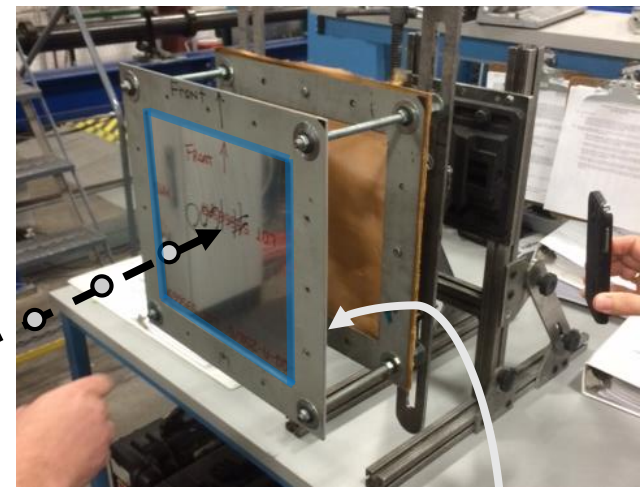

A NASA New Technology Report (NTR) has been filed for the MMOD detection method described in this technical presentation and is therefore patent protected. Those interested in using the method should contact the NASA Fiber Optic Sensing System Subject Matter Experts for more information

# MMOD Impact Detection (Target 1)

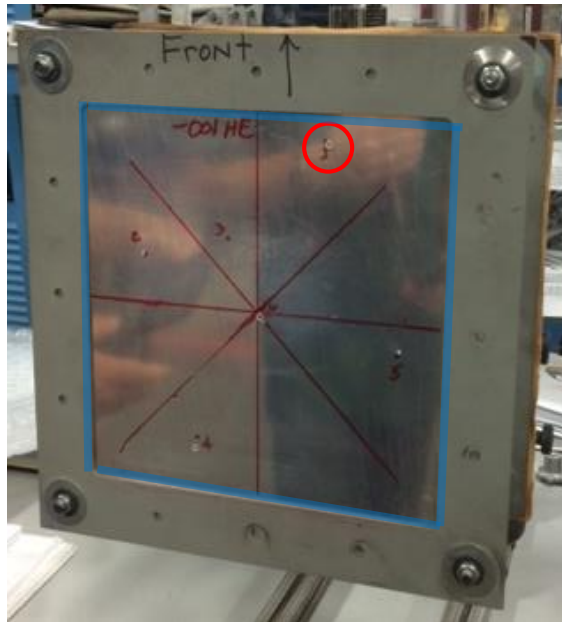

## Target 1

Projectile Diameter: 0.99mm  
Projectile mass: 0.0014g  
Projectile Velocity: 7,100 m/s

Use Fiber Optic Sensors to determine:

1. If an impact occurred
2. When did the event occur
3. Where did the impact occur
4. Quantify Damage

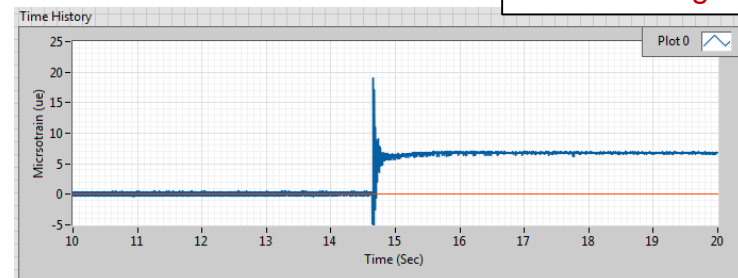
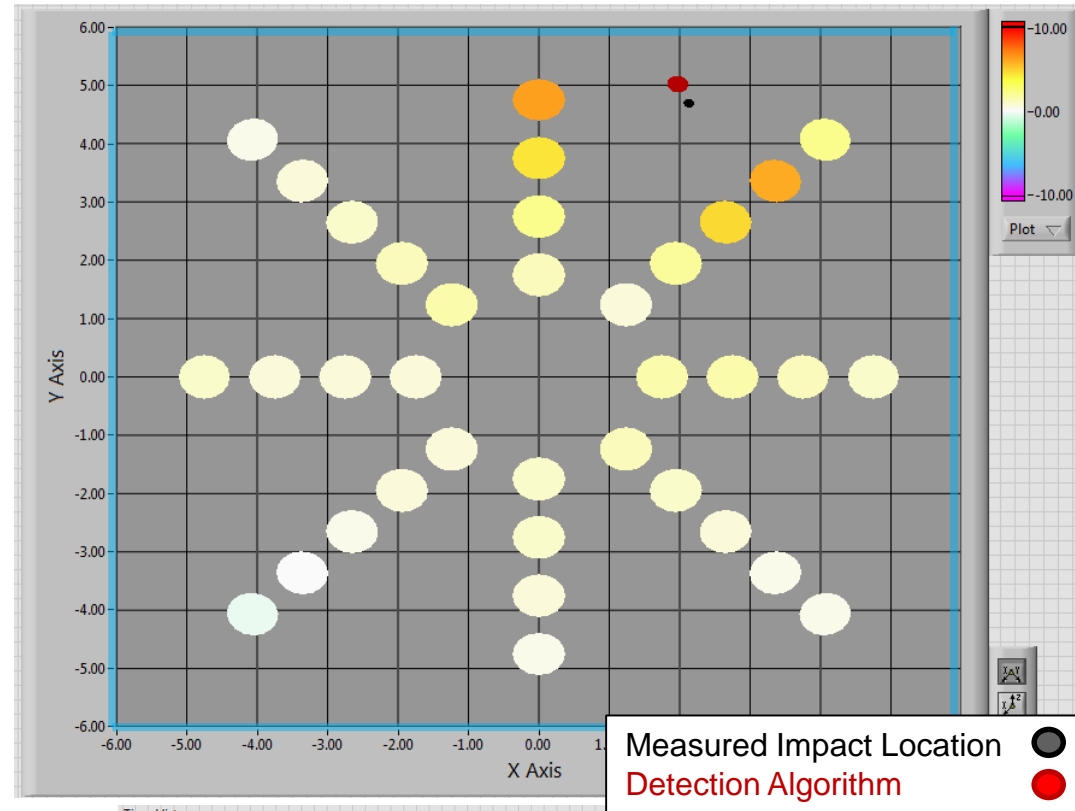

A NASA New Technology Report (NTR) has been filed for the MMOD detection method described in this technical presentation and is therefore patent protected. Those interested in using the method should contact the NASA Fiber Optic Sensing System Subject Matter Experts for more information

# MMOD Impact Detection (Target 2)

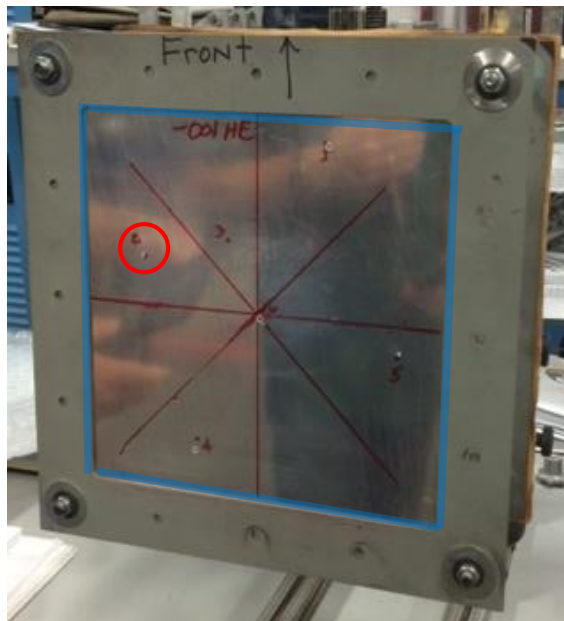

## Target 2

Projectile Diameter: 0.49mm

Projectile mass: 0.00017g

Projectile Velocity: 6,980 m/s

Use Fiber Optic Sensors to determine:

1. If an impact occurred
2. When did the event occur
3. Where did the impact occur
4. Quantify Damage

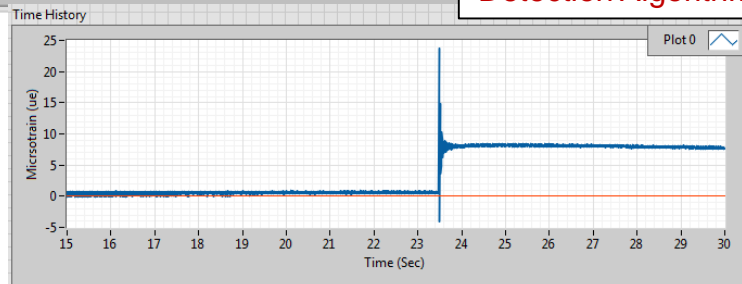
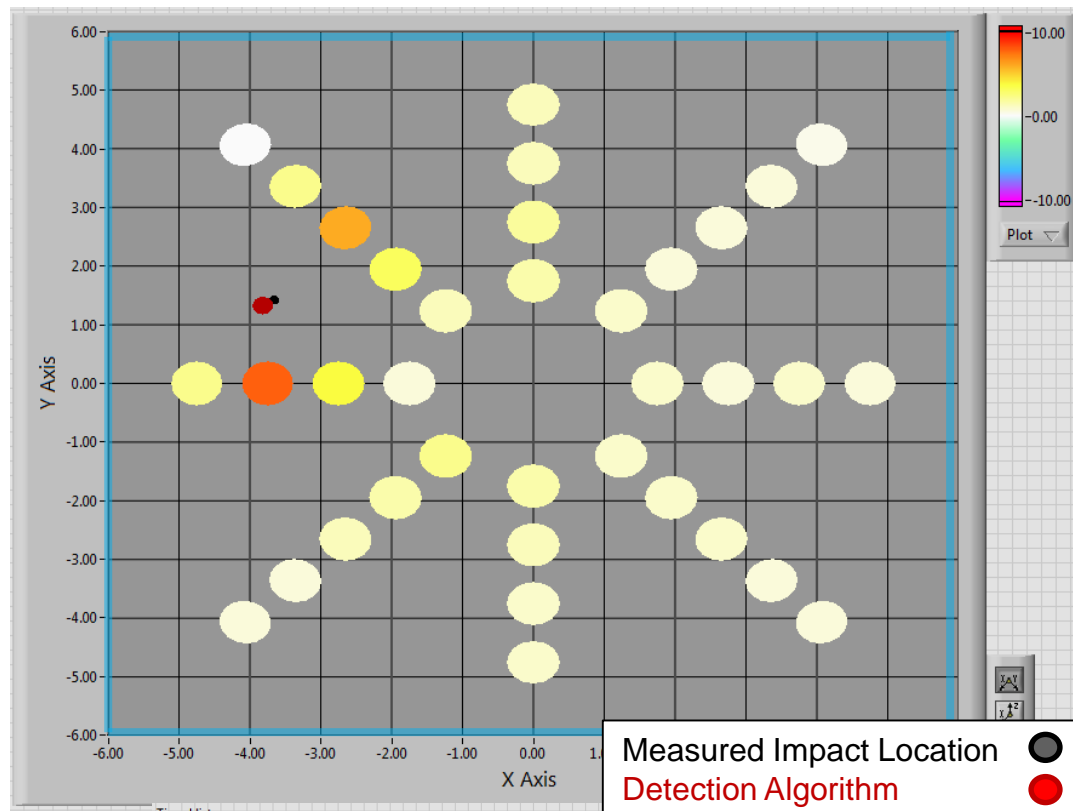

A NASA New Technology Report (NTR) has been filed for the MMOD detection method described in this technical presentation and is therefore patent protected. Those interested in using the method should contact the NASA Fiber Optic Sensing System Subject Matter Experts for more information

# Strain Sensing

## NESC Composite Crew Module

- Four fibers were installed around the module's three windows and one hatch
- 3300 real-time strain measurements were collected at 30Hz as the module underwent 200%DLL pressurization testing
- Measured strains were compared and matched well to predicted model results
- Project concluded:
  - “Fiber optics real-time monitoring of test results against analytical predictions was essential in the success of the full-scale test program.”
  - “In areas of high strain gradients these techniques were invaluable.”

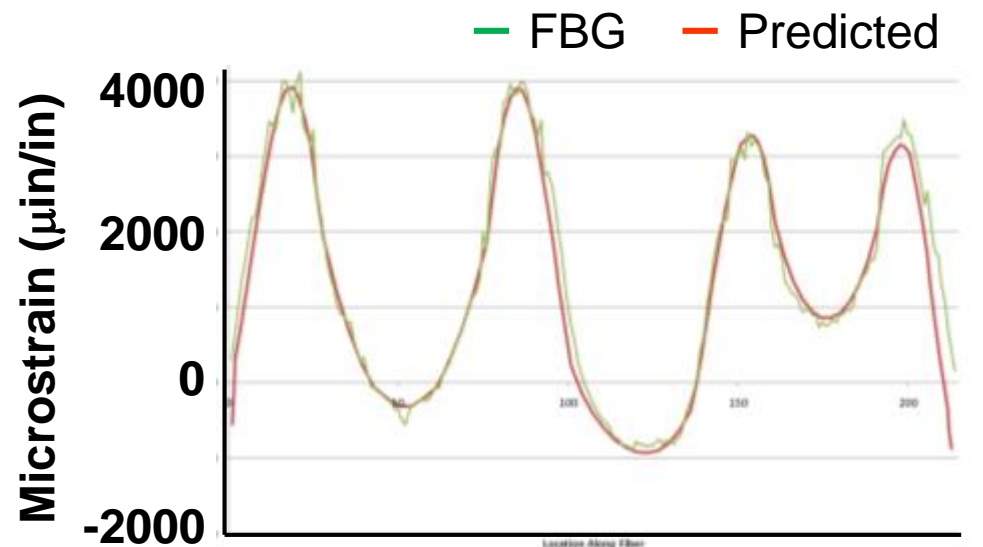

Inner Hatch FBG Strains, Max Pressure

# In-Flight Strain Sensing Small Scaled UAV

- Four Fibers were installed on the aircraft wings on top and bottom of the Left and Right wing
- 2000 time strain measurements were collected at 20Hz during flight

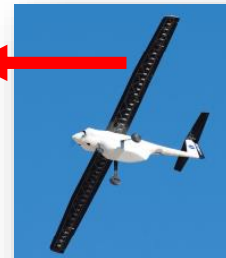
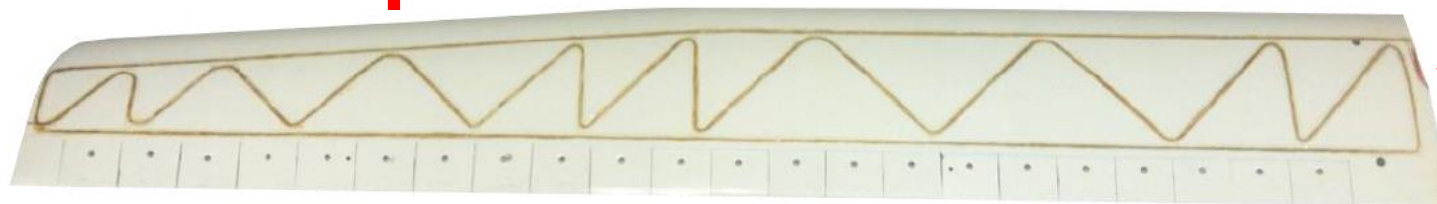
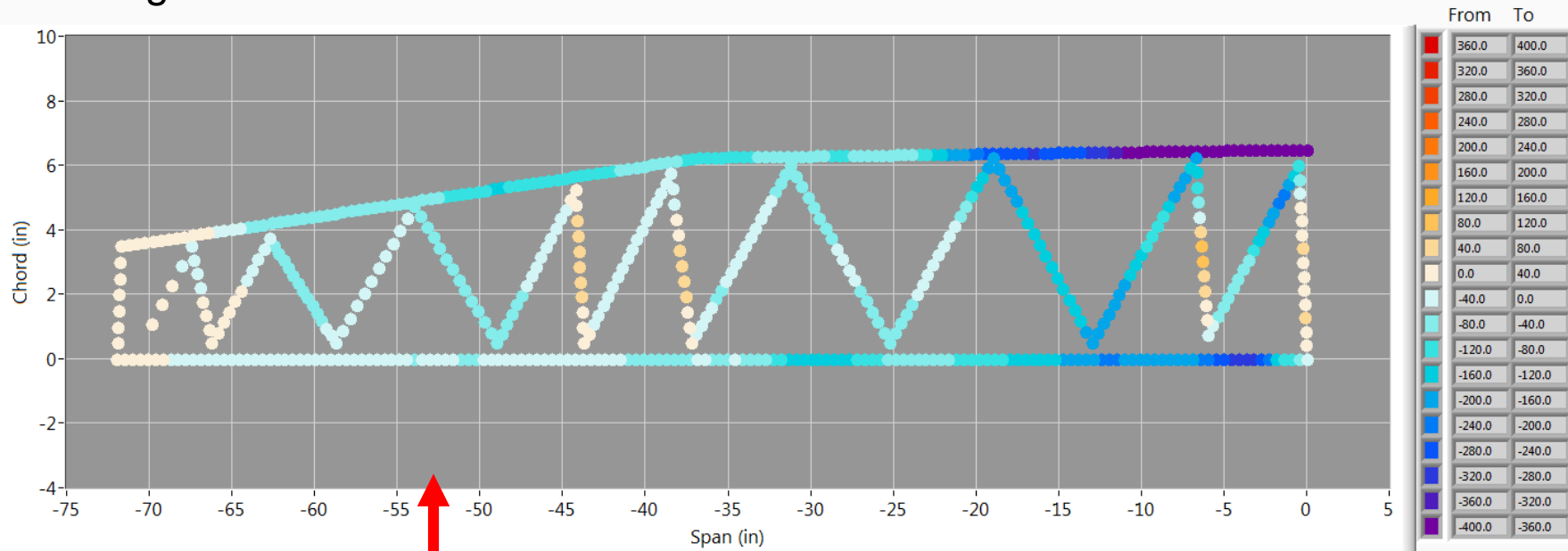

# Current Project:

## NESSC Shell Buckling Knockdown Factor (SBKF)

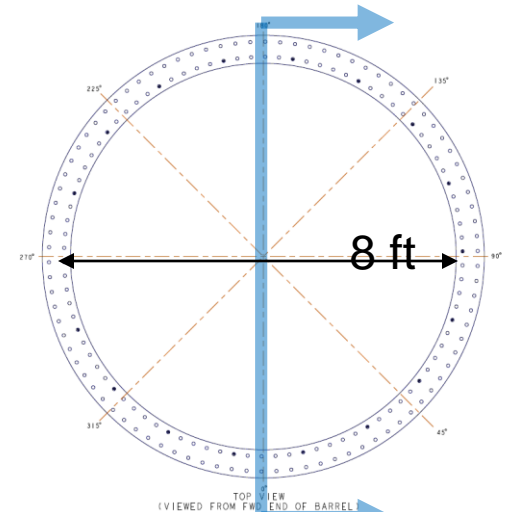
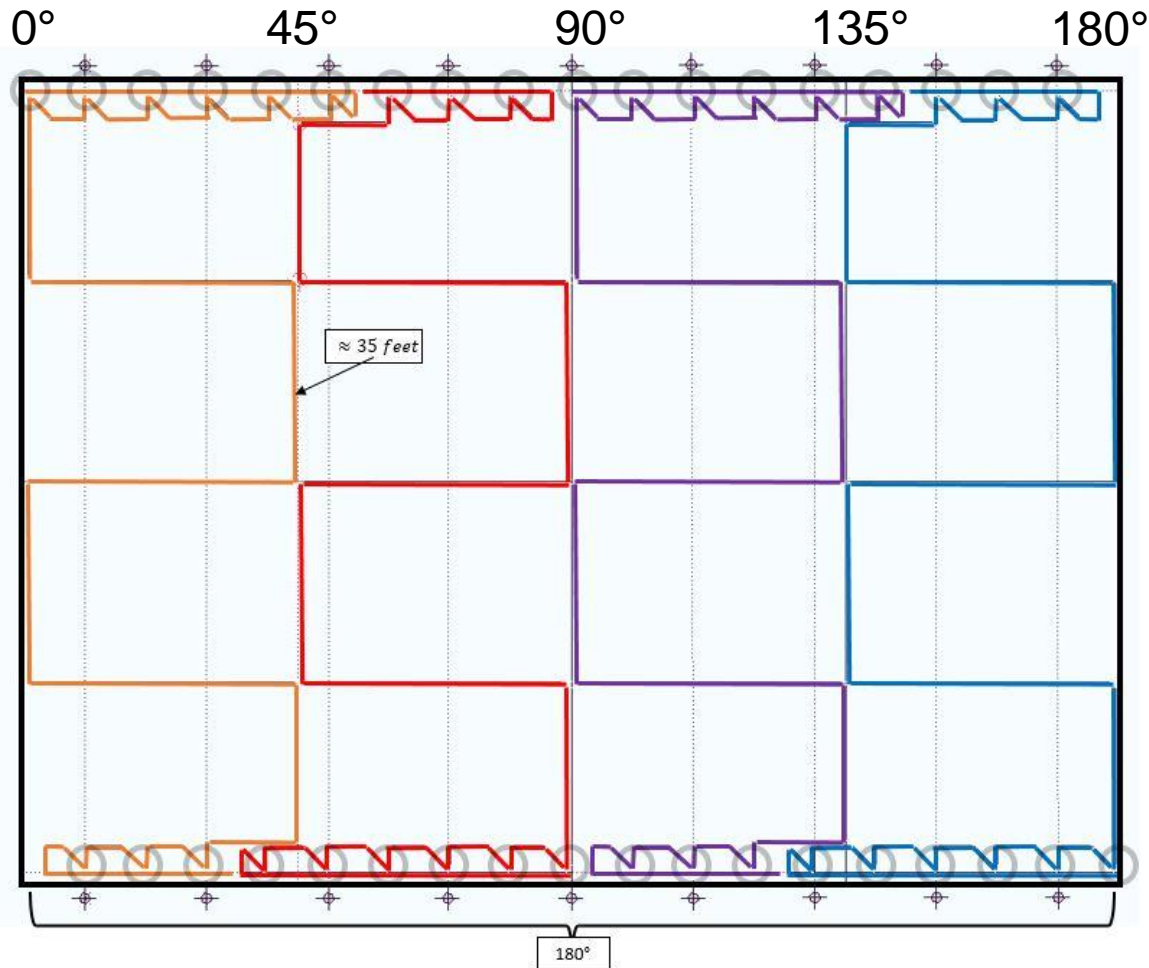

# Current Project:

## Shell Buckling Knockdown Factor (SBKF)

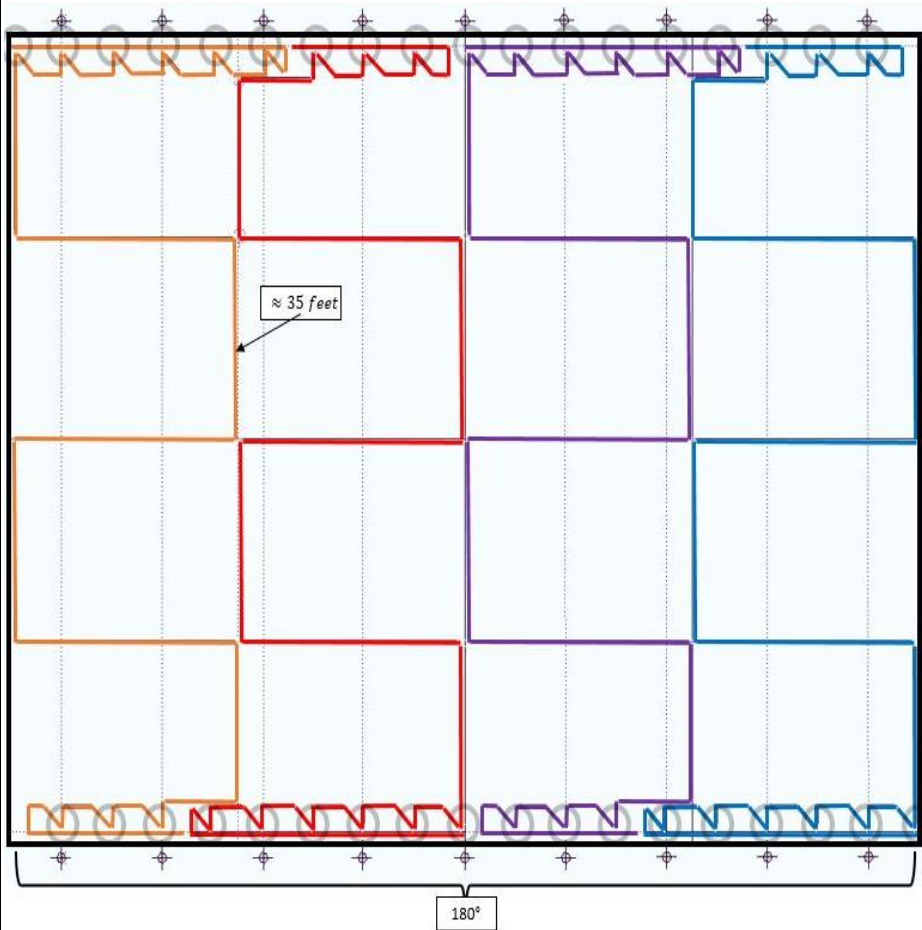

- FOSS Install goals
- Fibers installed on OML and IML surface
- Each fiber near 40 foot long
- FOSS rosette near each bolt interface plus a second rosette halfway between two bolts
- Nearly continuous axial measurements every 45° from top to bottom
- Five nearly continuous hoop measurements around the circumference of the cylinder
- No interference with existing conventional strain gage locations



# Current Project: Shell Buckling Knockdown Factor (SBKF)

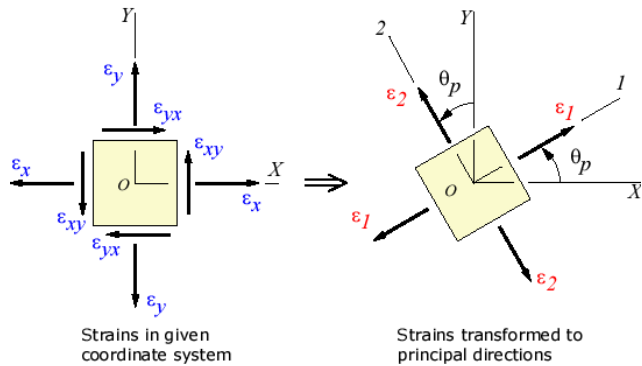

- Rosettes are installed in critically loaded areas
- Principle strain orientation and magnitude can be determined
- Distributed strain measurements could be used to verify proper load introduction into the test article

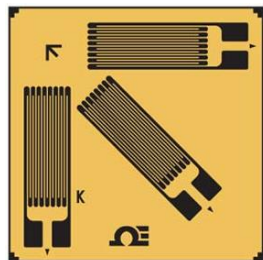

Example Conventional Rosette

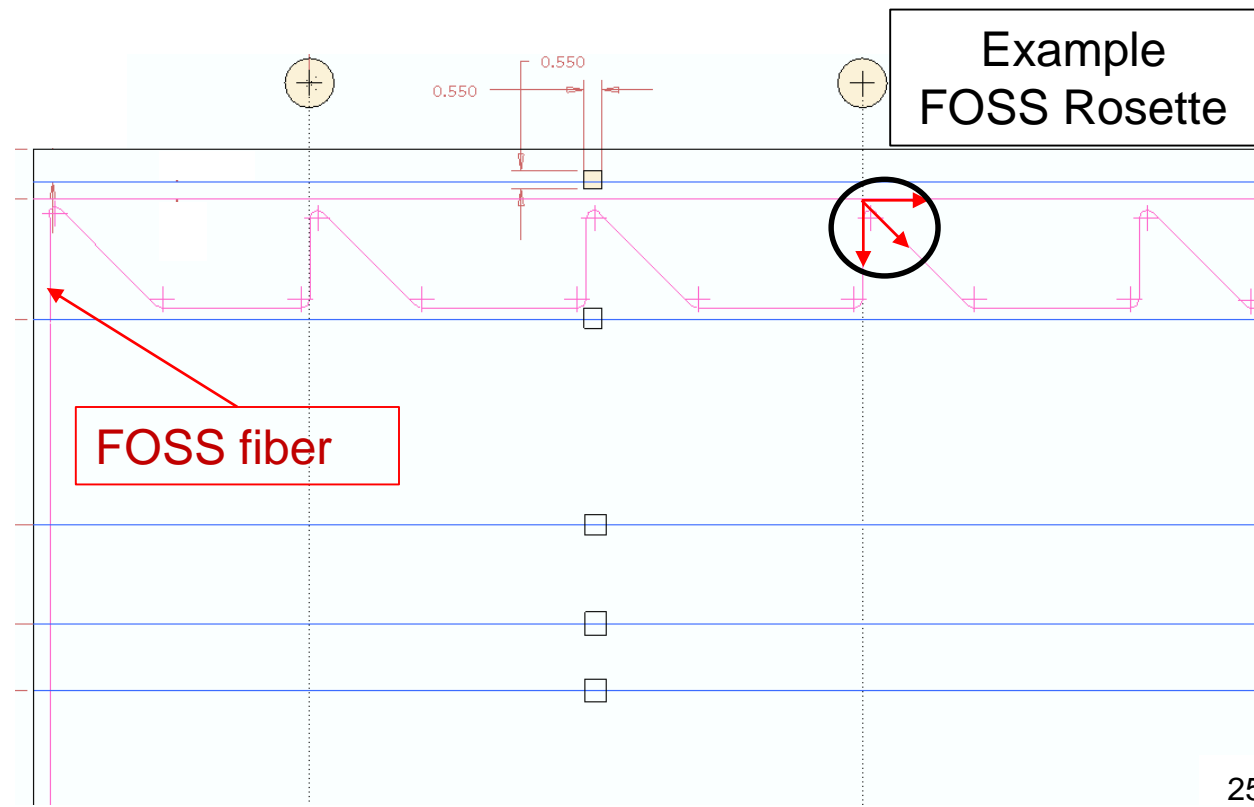

---

# Shape Sensing Applications

# Two Strain-Based Deflection Methods

## 2D Shape Sensing Method

- Uses structural strains to get deflection in one direction
- Fibers on top and bottom surface of a structure (e.g. wing)

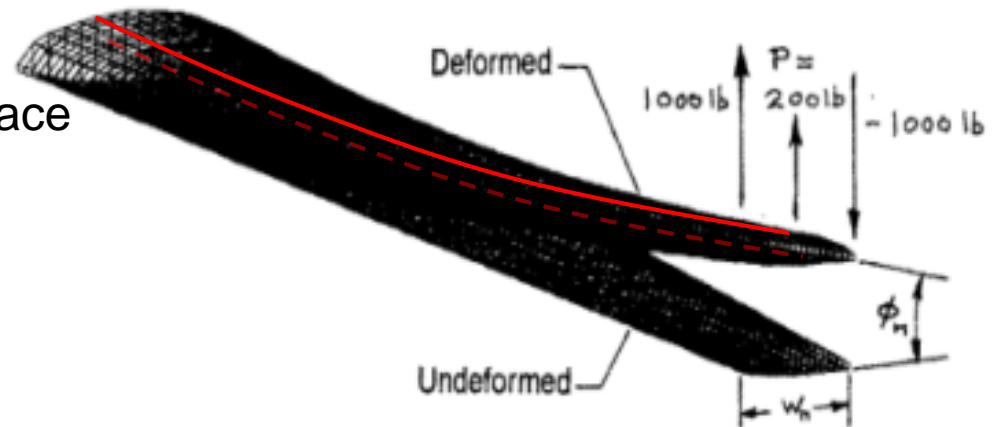

## 3D Shape Sensing Method

- Uses strains on a cylindrical structure to get 3D deflections
- 3 fibers 120 apart on a structure or a lumen

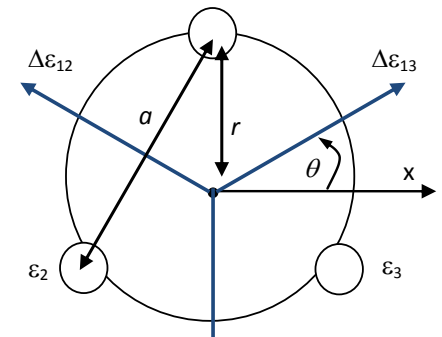
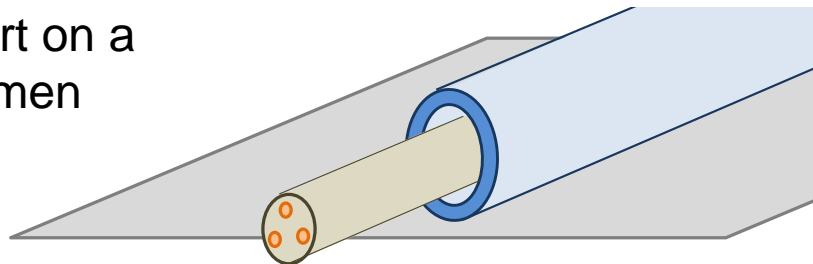

# Uninhabited Aerial Vehicles

## Global Observer UAS - Aerovironment

- Proof-load testing of components and large-scale structures

Global Observer Wing Loads Test

Wing Span: 175 ft

Whiffletree Loading System

# 2D Shape Sensing Results

## Global Observer UAS

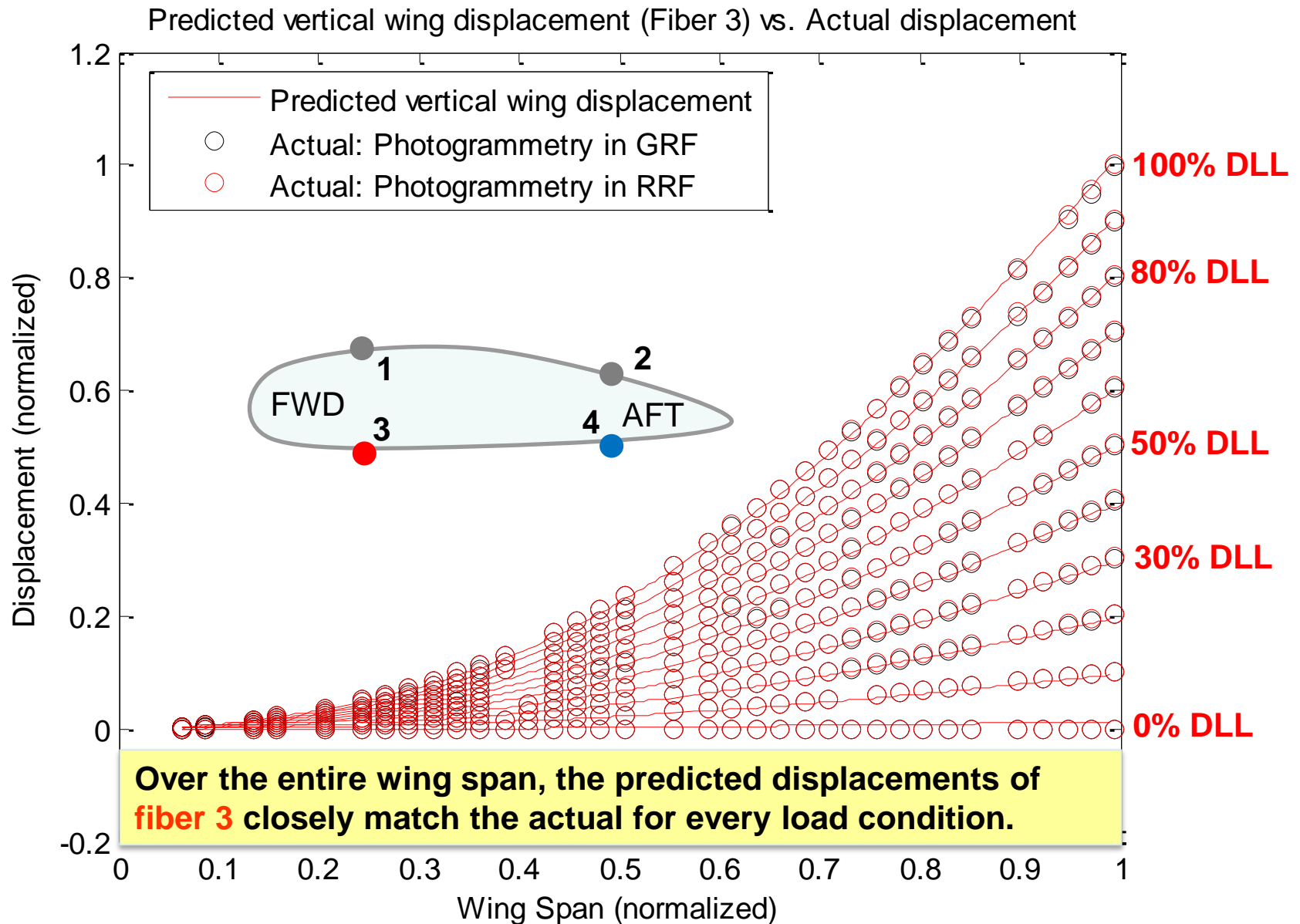

# 3D Shape Sensing

## Prototype Quiet Spike Testing

- Fibers are installed on the prototype of 35ft quiet spike at Gulfstream in Savannah GA
- Performed tests to determine benefits of deploying FOSS on Low Boom Experimental Vehicle
- Installed a total of 5 fibers measuring strain at  $\frac{1}{2}$ " increments (2,570 strain sensors)
- Deflection shape of the Quiet Spike evaluated through the 3D shape algorithm

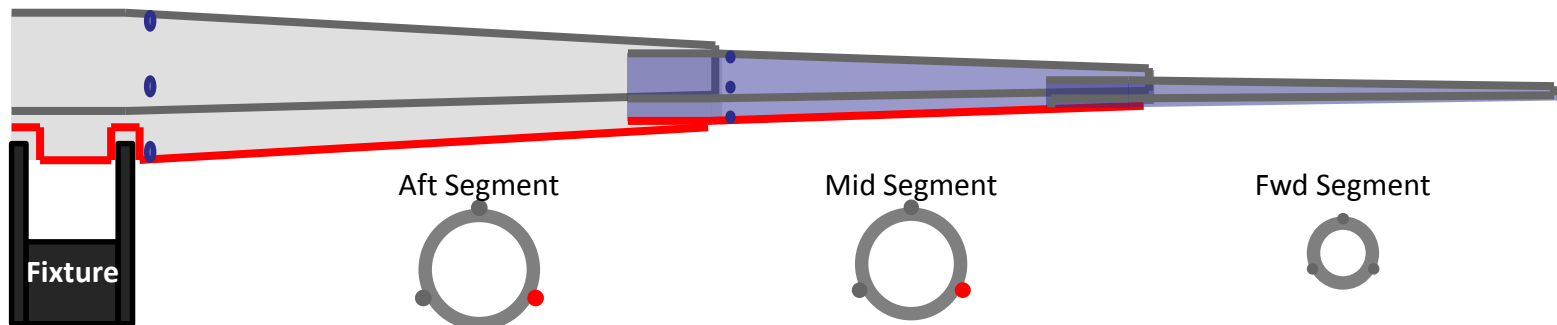
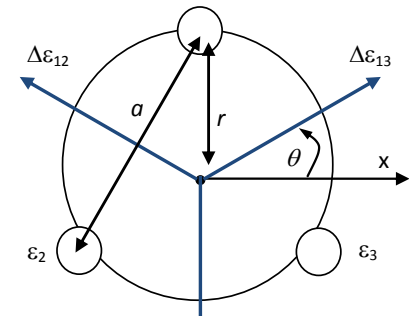

# 3D Shape Sensing

## Quiet Spike Testing Results – lateral deflection

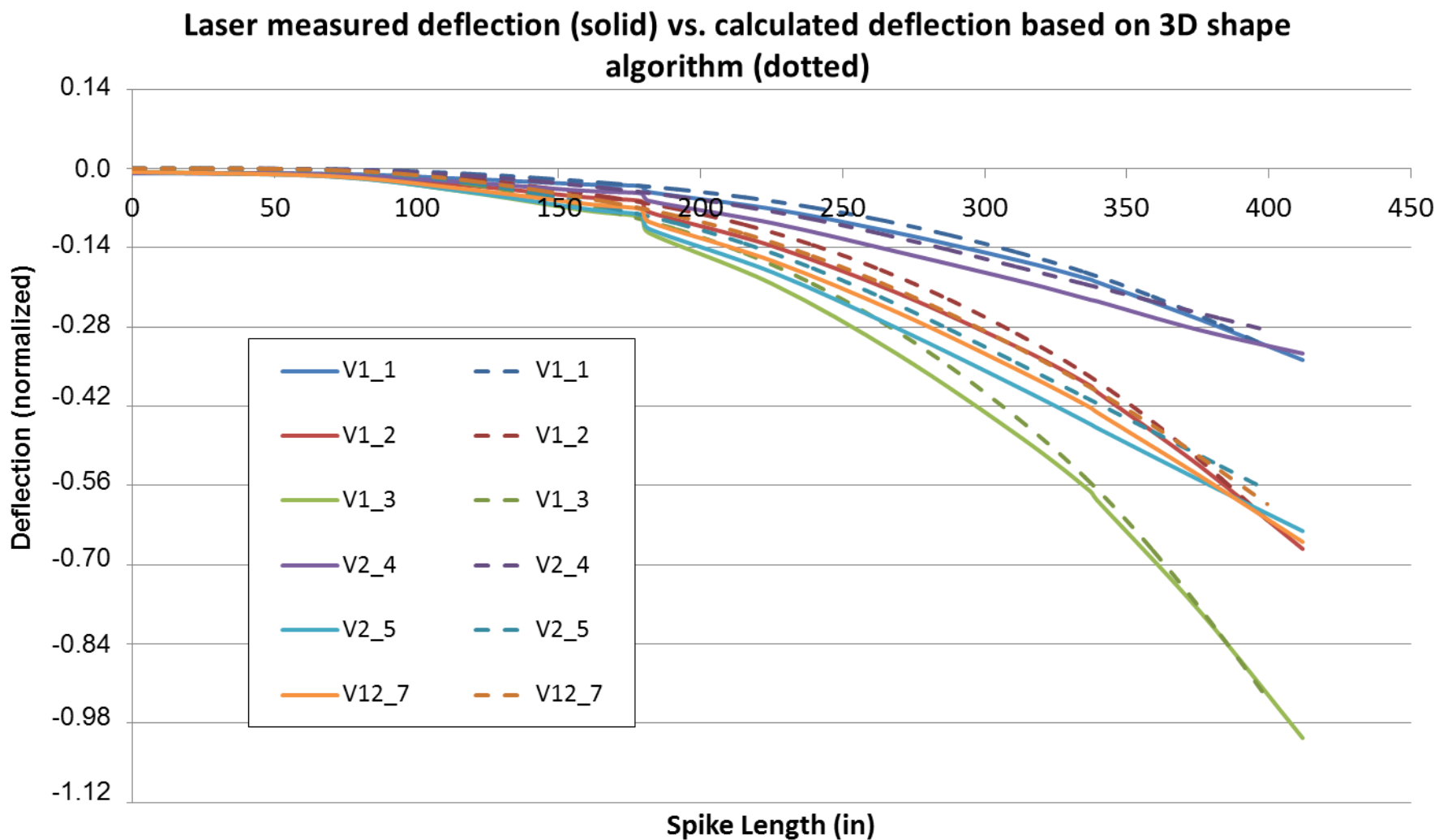

# 2D Shape + Twist Sensing

- Real-time algorithms enable vertical deflection and twist to be obtained from distributed strain measurements
- LabVIEW user interface allows the user to visualize an estimate of the full field deformation
- A digital inclinometer is used to verify twist estimates

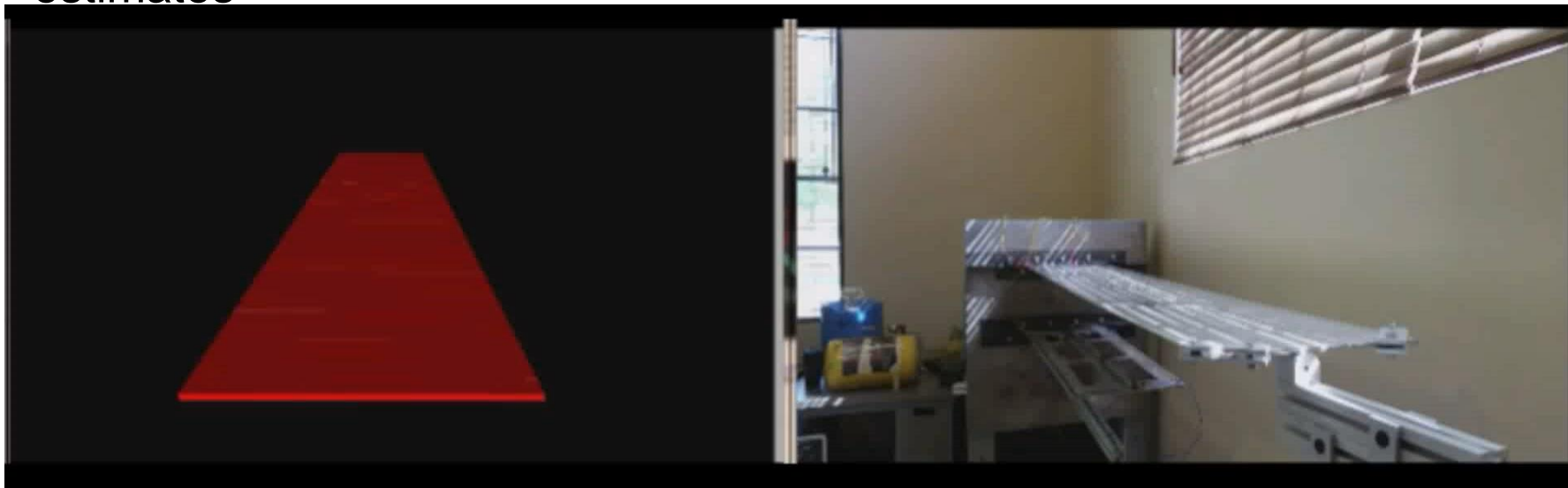

A NASA New Technology Report (NTR) has been filed for the Twist Sensing Method described in this technical presentation and is therefore patent protected. Those interested in using the method should contact the NASA Technology Transfer Program Office at NASA Armstrong Flight Research Center for more information



---

# Load Sensing

# Loads Calibration with conventional strain gage technology

Loads calibrations on A/C wings with conventional strain gages have been successfully performed for over 50 years

- Skopinsky and Aiken Loads Calibration Method allows engineers to obtain:
  - Lift or Shear Force
  - Bending Moment
  - Pitching Moment or Torque

## Typical Conventional Loads Calibration requires:

- Dozens of metallic strain gages
  - One sensor per channel
  - Installed on interior load bearing structure of wing
  - Wing skins need to be removed
  - Installation time of approx. 4 to 8 hours per sensor
  - Finite point measurements
- Removal of ground-test-specific instrumentation prior to flight
  - Bulky sensor size restricts the use in high lift regions
- 16 channels of load actuators
  - Application of an array of mechanical loads to determine bending and torsional stiffness properties
- Limited Span-wise load sensing capabilities



Conventional Loads Calibration Setup

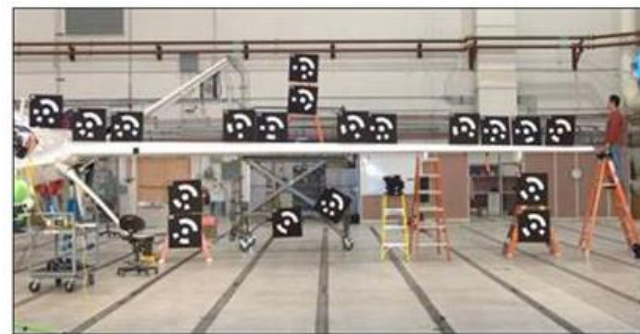

Simplified Approach with FOSS

# Investigations of Fiber Optic Sensing System (FOSS) for Distributed Load Calibration Methodology

## Technical Challenge:

- Future projects require a method for monitoring the load distribution within aerospace structures
- Instrumentation weight and installation time of conventional strain gages limit the ability to monitor and control distributed loads within aerospace structures



Helios Wing



In-flight breakup

## Current State-of-the-Art:

- Fiber optic strain sensing (FOSS) technology is transitioning to an airworthy alternative to conventional strain gages and will change the approach to aircraft loads calibrations
- FOSS will open up new opportunities to monitor and facilitate control of future launch vehicles

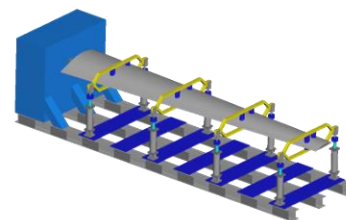

## Potential Applications:

- Improved understanding of distributed aerodynamic loading
- Optimized process for aircraft structural loads calibrations for monitoring and controlling flexible, high aspect ratio wings and rocket bodies
- A detailed understanding of the span-wise load distribution will be required for optimizing the aerodynamic performance of future aerospace structures

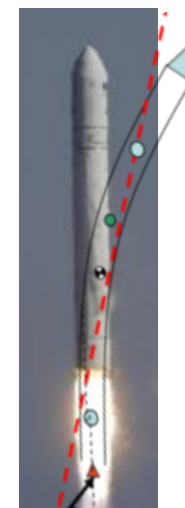
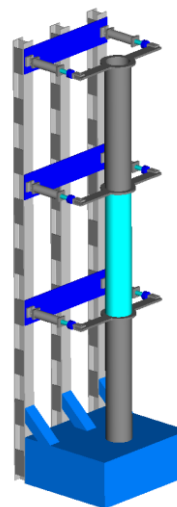

Shape sensing for vehicle control 35

# Aircraft Vehicle Load Control

- **cFOSS 1.0 sUAS Flight system specifications (Convection)**

- 4 Fiber system
- Total sensors: 4000
- Sample rate (max) 100 sps
- Weight 5 lbs
- Size 3 x 5 x 11in

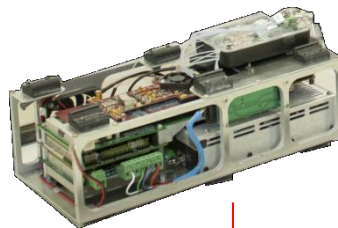

- **Autonomously Piloted Vehicle 3 (APV3)**

- Span: 12 ft
- Max Takeoff Weight: 55 lbs
- 22 control surfaces per wing
- 2,000 fiber optic strain sensors on wings (top and bottom surfaces)

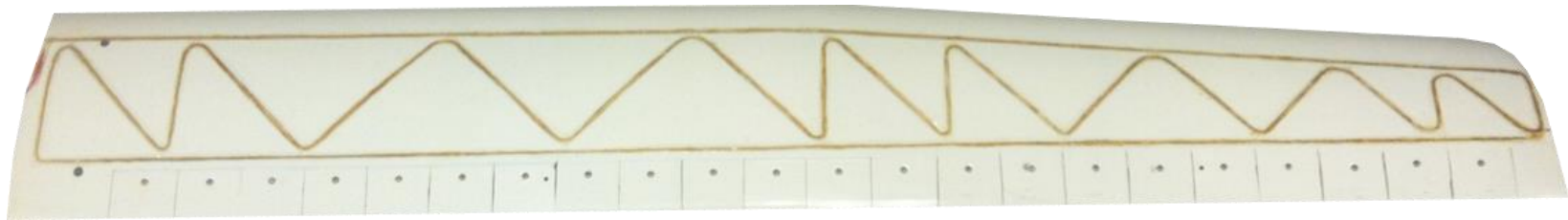

# APV3 Segmented Control Surfaces

- Segmented Control Surfaces (SCS) can be utilized to redistribute load in-board to reduce loads during high-g maneuvers
- FOSS strain and/or deflection measurements could be used with a flight controller to provide load alleviation control

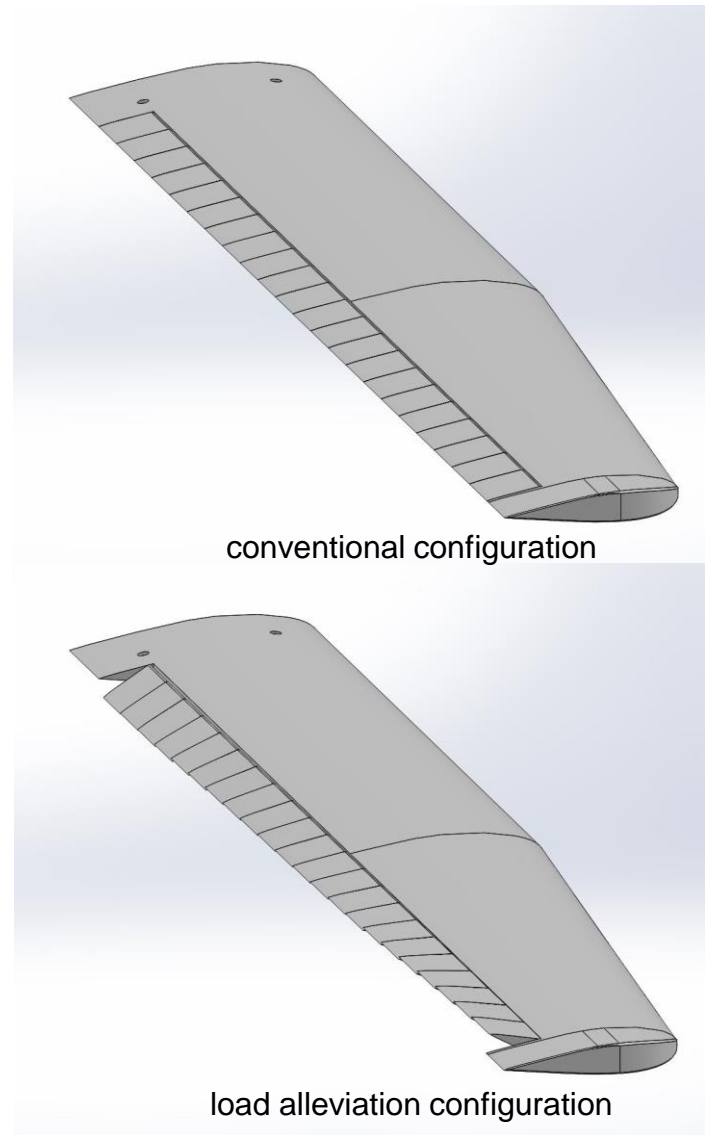
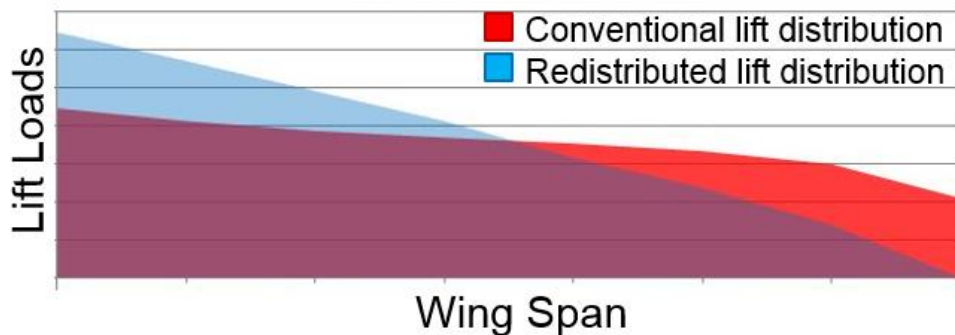

# Operational Load Estimation Method Applied Results With Flight Data



APV3 in flight

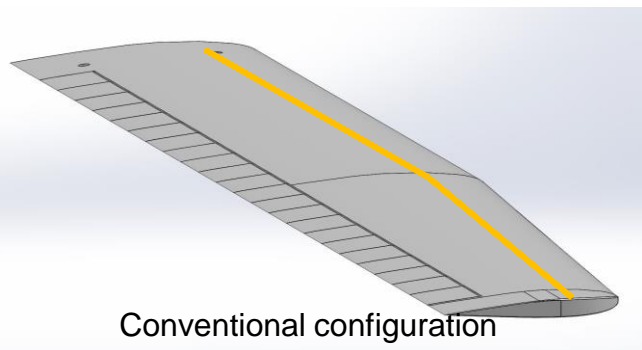
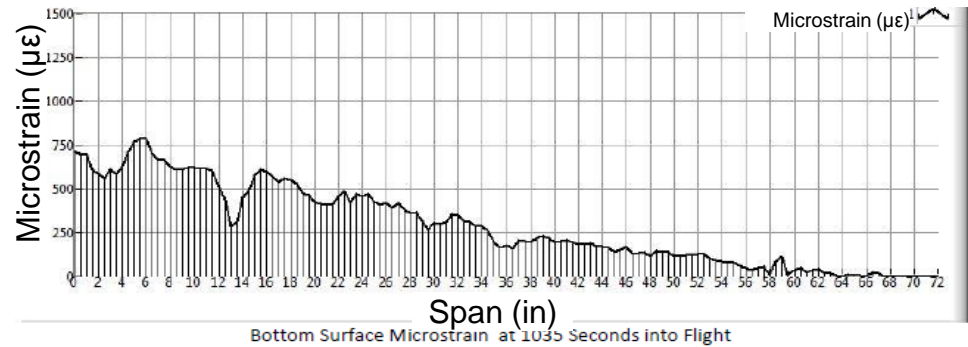
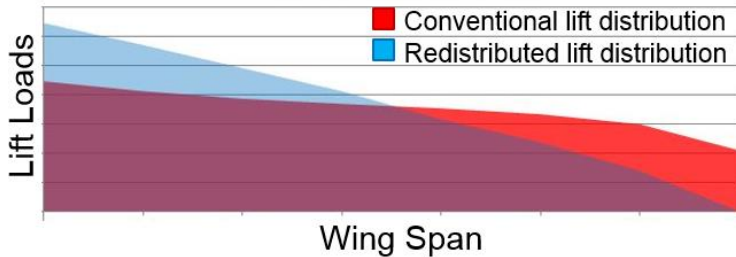
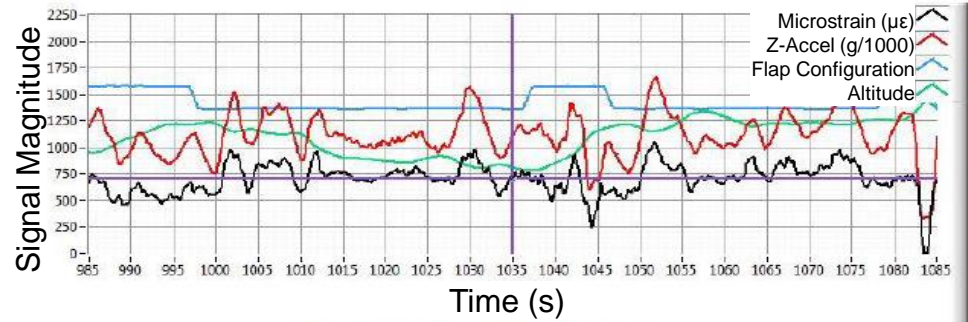

Conventional configuration

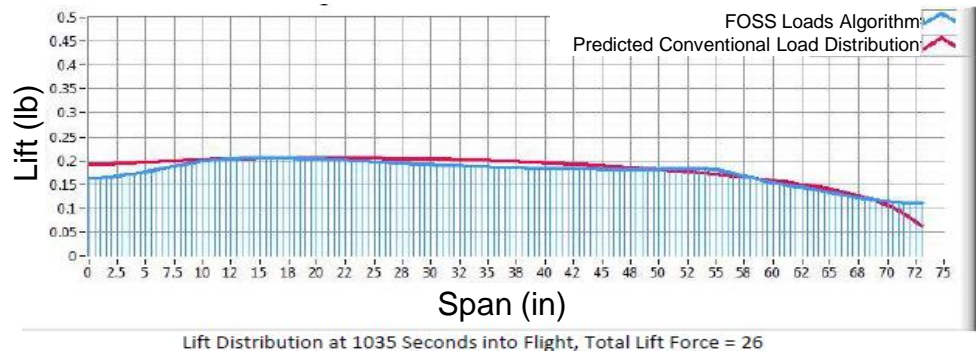

A NASA New Technology Report (NTR) has been filed for the Load Sensing Method described in this technical presentation and is therefore patent protected. Those interested in using the method should contact the NASA Technology Transfer Program Office at NASA Armstrong Flight Research Center for more information

# Operational Load Estimation Method Applied Results With Flight Data



APV3 in flight

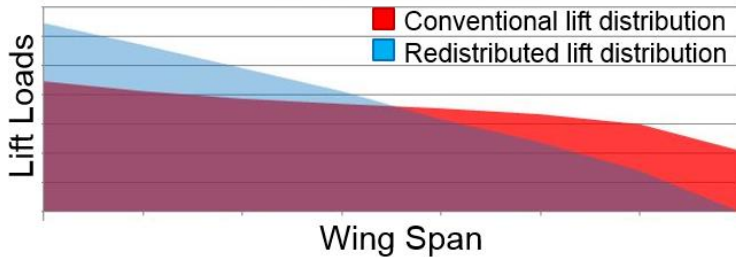

Wing Span

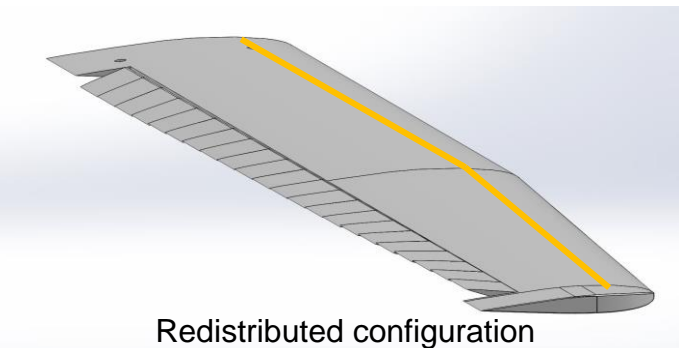

Redistributed configuration

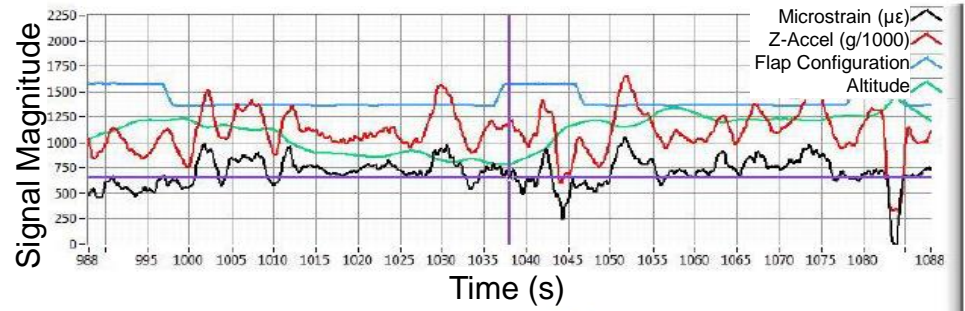

Flight Data at 1038 Seconds into Flight

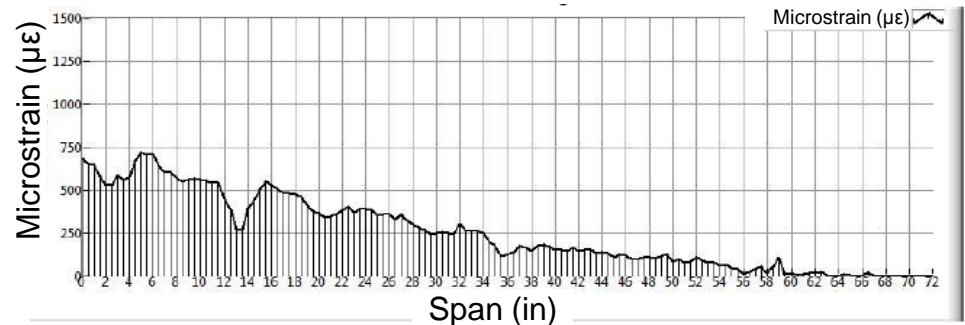

Bottom Surface Microstrain at 1038 Seconds into Flight

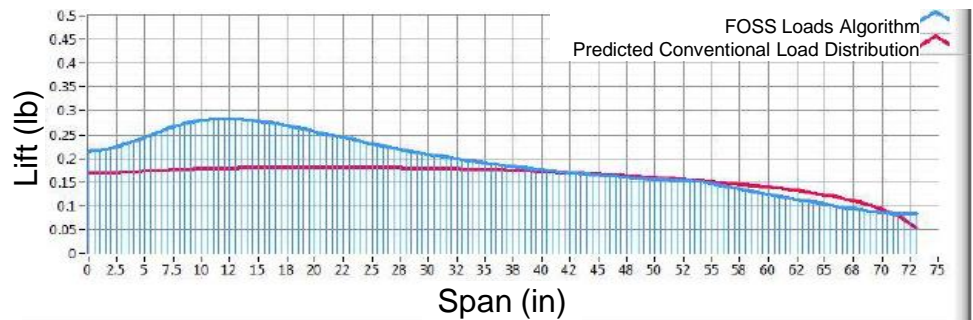

Lift Distribution at 1038 Seconds into Flight, Total Lift Force = 28

A NASA New Technology Report (NTR) has been filed for the Load Sensing Method described in this technical presentation and is therefore patent protected. Those interested in using the method should contact the NASA Technology Transfer Program Office at NASA Armstrong Flight Research Center for more information

# Operational Load Estimation Method

## Trusses and Moment Frames



Moment Frame Test Article with FOSS

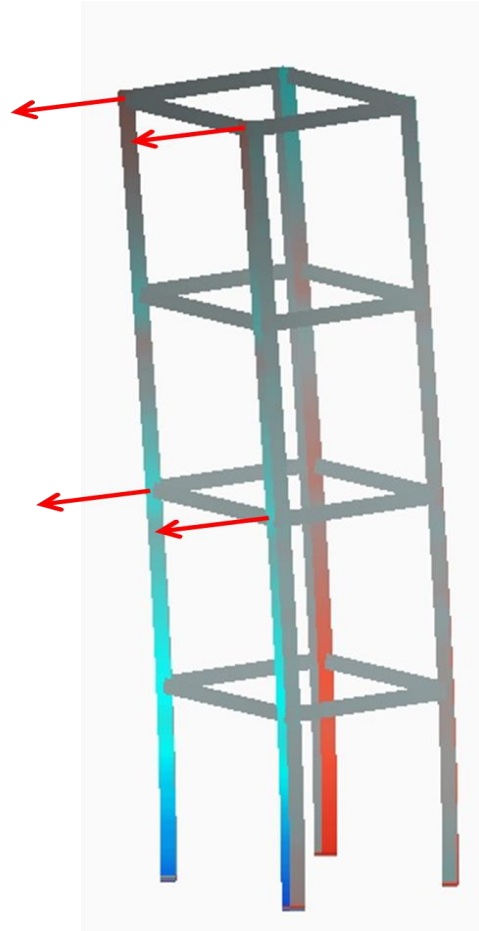

Real-time display of FOSS data

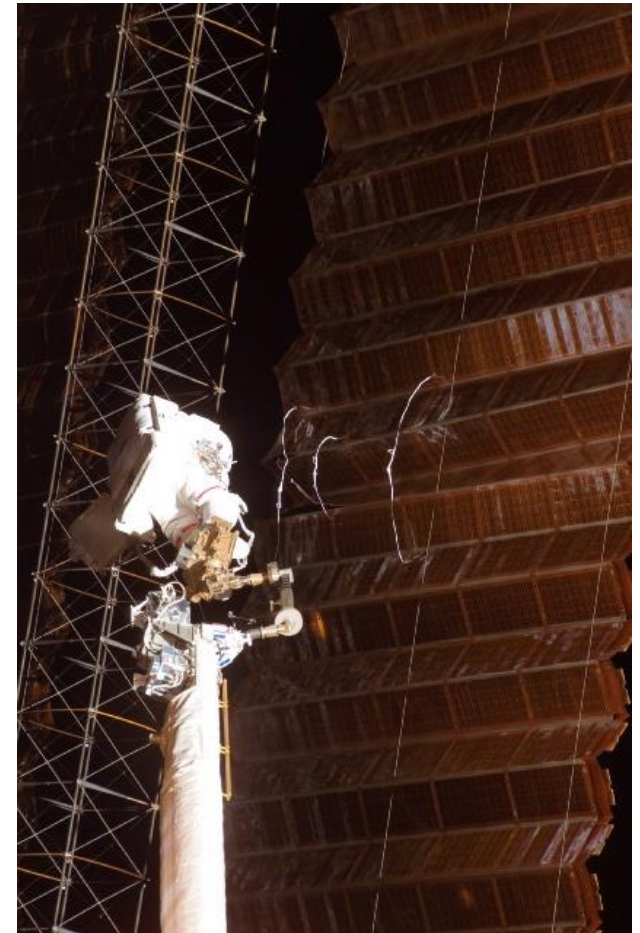

Solar Array and truss structure



# Operational Load Estimation Method

## Truss and Moment Frames

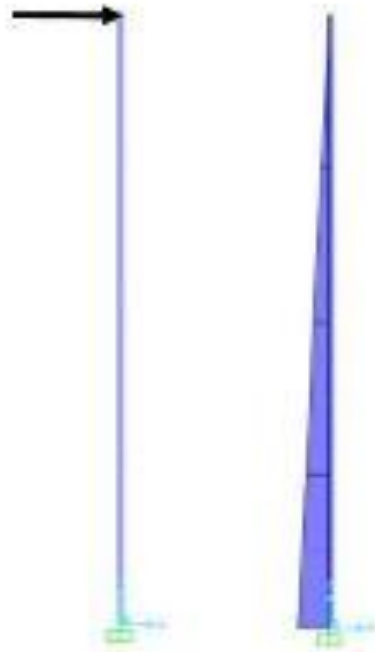

Cantilever  
Moment  
Diagram

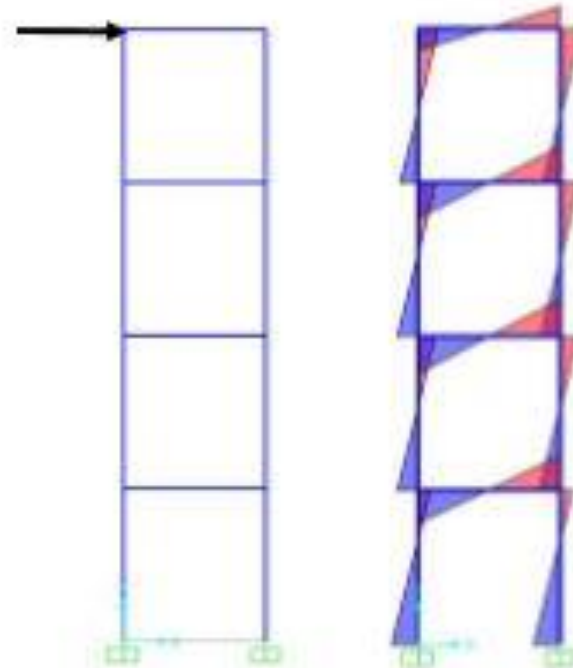

Frame Moment  
Diagram

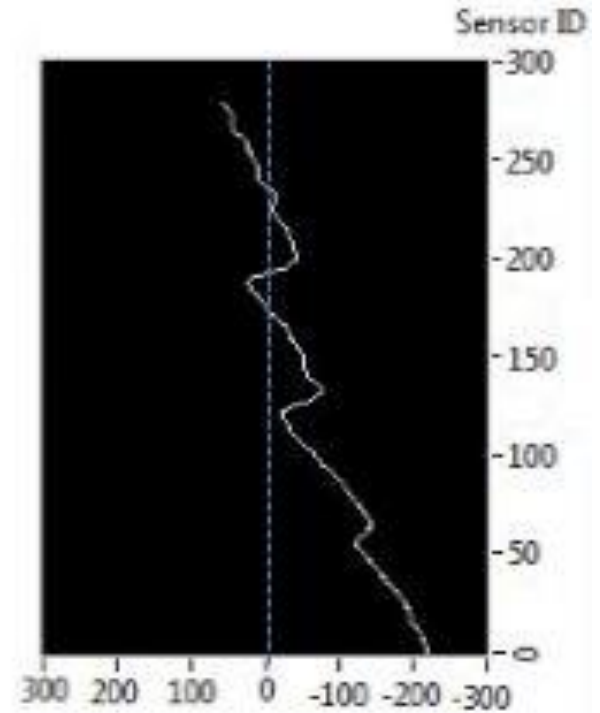

Measured Moment  
Diagram on Column  
*(Showing Semi-Frame  
Behavior)*

# Operational Load Estimation Method

## Truss and Moment Frames



Moment Frame Test Article with FOSS

### Preliminary OLEM Test Results on Moment Frame Test Article

Test (#)	Actual Force (lbf)	Estimated Force (lbf)	Difference (%)	Actual Location (in)	Calculated Location (in)	Difference (%)
1	10.0	10.0	0.0%	67.5	67.5	0.0%
2	10.0	9.1	-9.0%	60.5	61	0.8%
3	10.0	9.0	-10.0%	50.5	50.6	0.2%
4	5.0	5.4	8.0%	50.5	50.6	0.2%
5	10.0	10.3	3.0%	43	43.9	2.1%
6	5.0	5.0	0.0%	43	42.9	-0.2%
7	5.0	4.8	-4.0%	32.75	33.8	3.2%
8	10.0	9.0	-10.0%	32.75	33.8	3.2%
9	10.0	8.9	-11.0%	25.5	25.9	1.6%
10	5.0	5.1	2.0%	25.5	25.7	0.8%

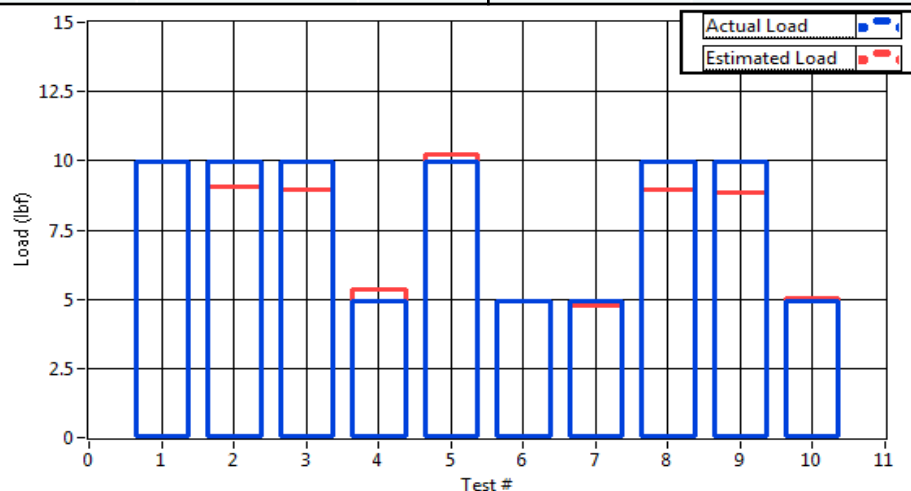

A NASA New Technology Report (NTR) has been filed for the Load Sensing Method described in this technical presentation and is therefore patent protected. Those interested in using the method should contact the NASA Technology Transfer Program Office at NASA Armstrong Flight Research Center for more information

# HyFOSS

# HyFOSS: What The Technology Does

- Hybrid fiber optic sensing system (HyFOSS) is a combination of two existing technologies both based on fiber Bragg gratings
- Technology #1: Wavelength Division Multiplexing (WDM) allows for high speed (kHz) acquisition speed but low number of gratings per fiber
- Technology #2: Optical Frequency Domain Reflectometry (OFDR) allows for high spatial resolution (1000s of grating) but inherently low sample rates (<100Hz)
- To combine the best of both technologies coupled on to the **same fiber** allows for high spatial resolution (lower sample rates) along the entire length of the fiber using OFDR as well as high sample rates at strategic points along the fiber using WDM



Example hyFOSS fiber layout

- High speed WDM sensor
- OFDR 1/4" Spatial Resolution

# HyFOSS, Frequency Sweep Vibration Testing

## Experimental setup

- Cantilever test article with discontinuous section properties.
- A Finite Element Model has been created to determine strain gage locations
- Aluminum wing plate structure is excited by an electrodynamic shaker
- 7 Accelerometers are mounted to the structure to monitor structure mode shapes
- OFDR and WDM sensors (3) are bonded to the plate
- Test article is 36 inches long and 12 inches wide

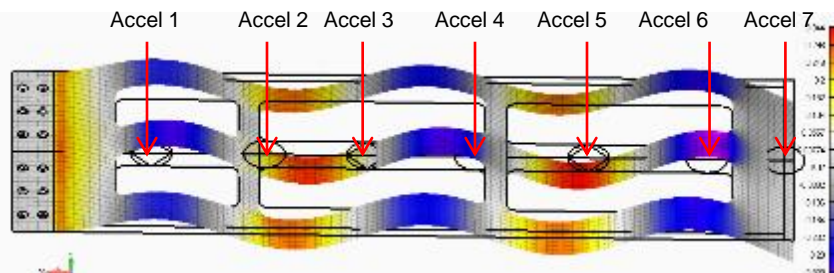
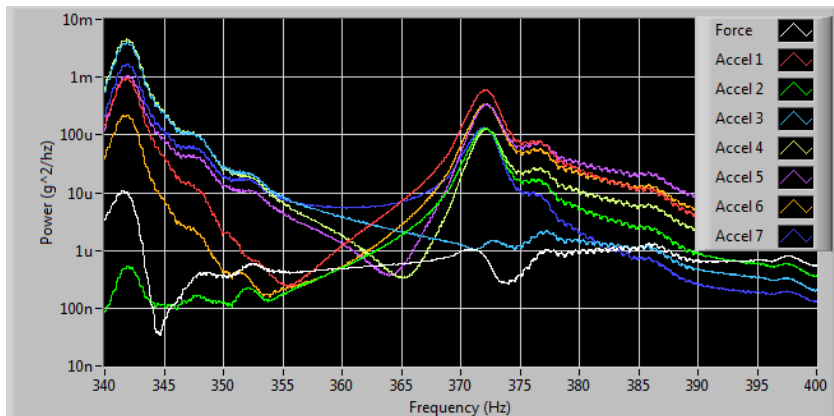

WDM / High Speed Fiber Optic Sensor

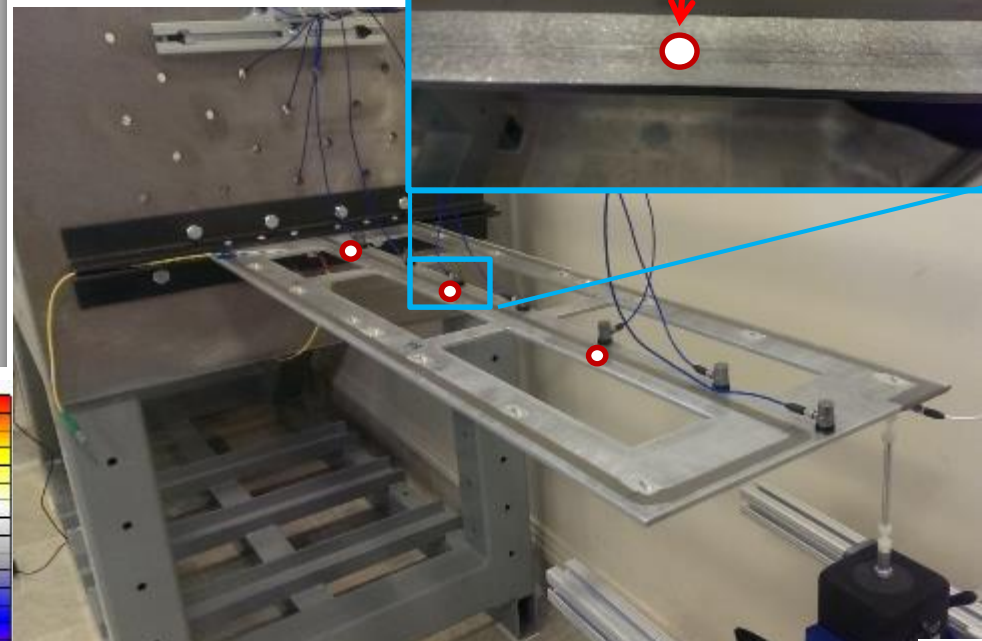
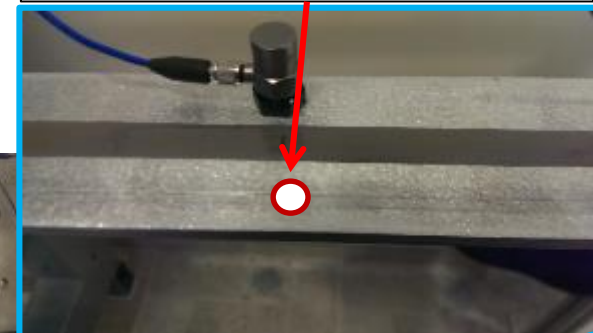

# HyFOSS Sensor Installation

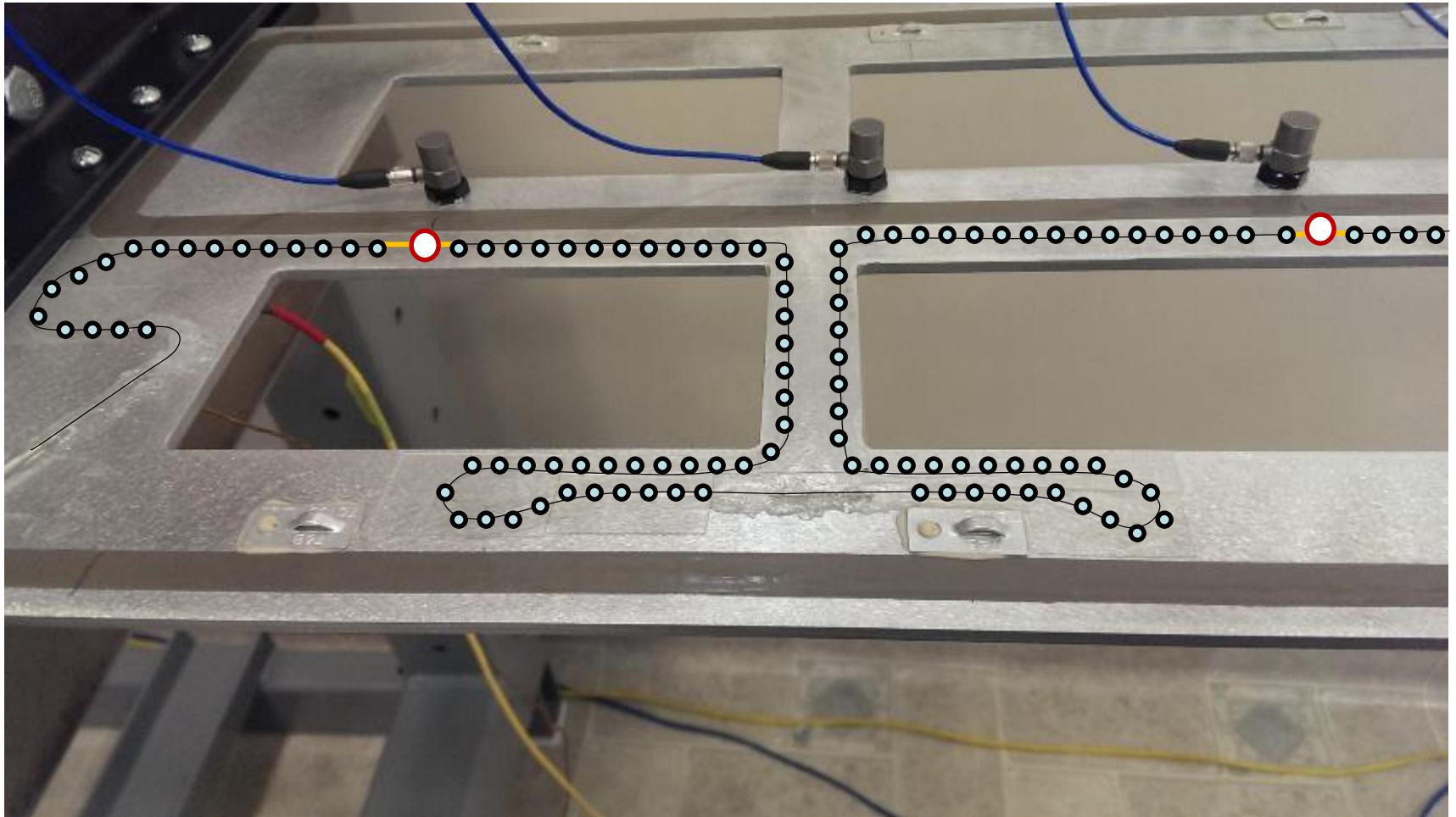

- - 100 Hz (OFDR)
- - 5,000 Hz (WDM)

# HyFOSS test – Fiber Optics & Accelerometer

## Frequency Sweep 475 Hz to 525 Hz

National Aeronautics and Space Administration

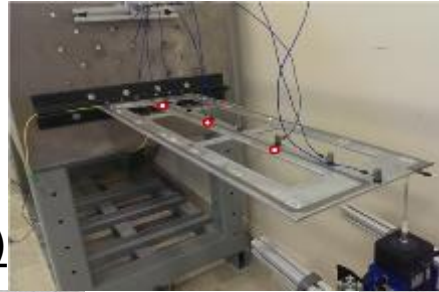

High Speed Fiber Optics (5 kHz)

Accelerometers (8 kHz)

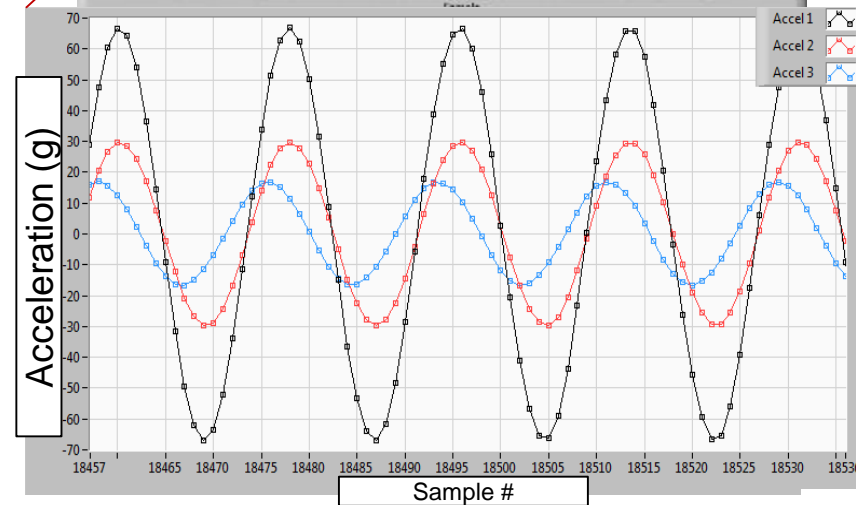
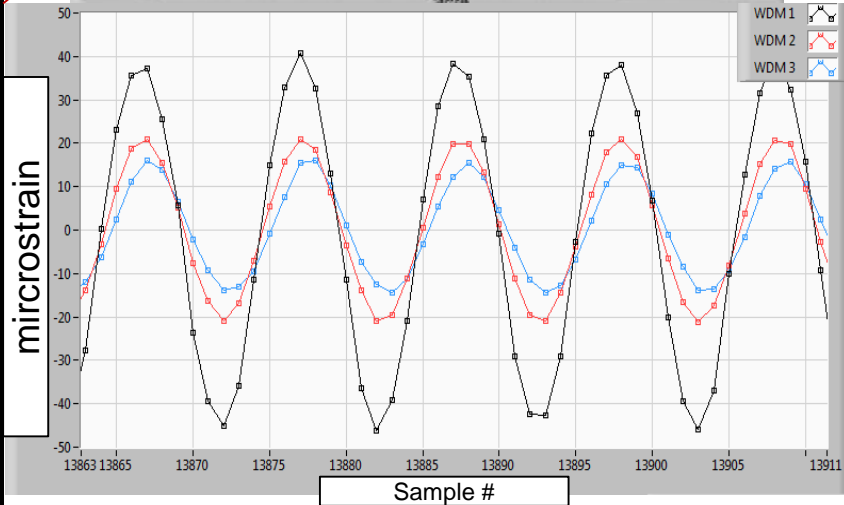
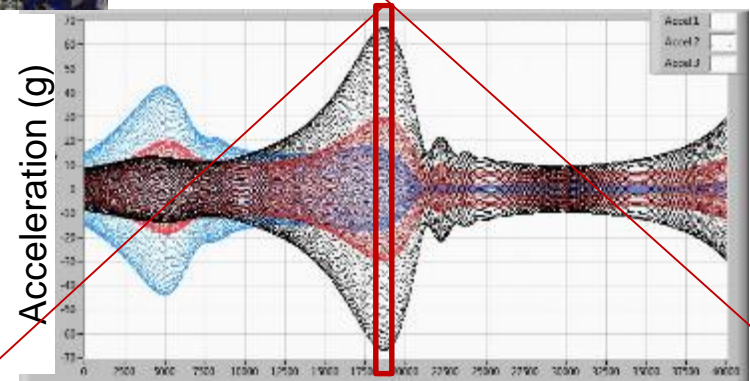
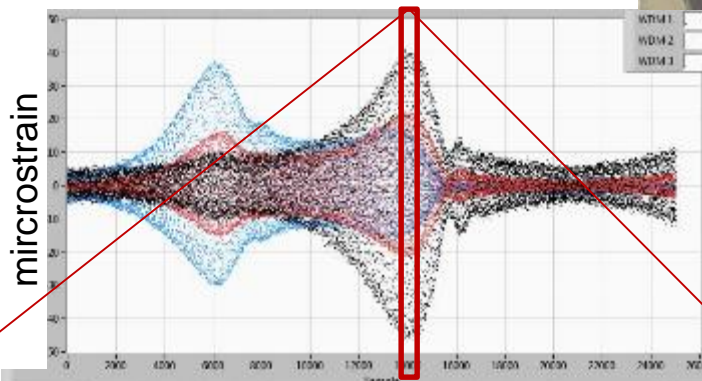





# Dedicated High Speed Testing, Impact Test

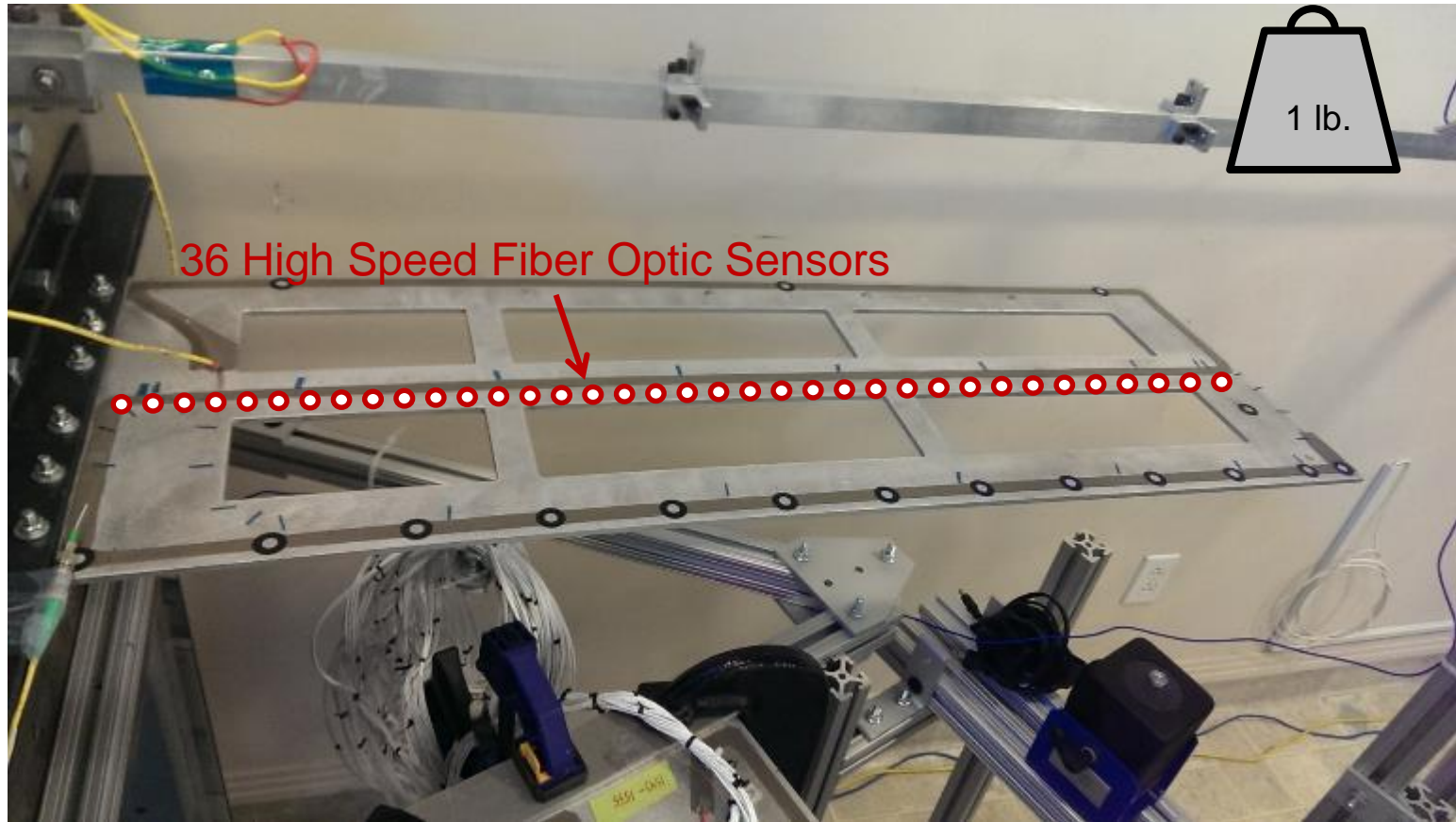

# Impact test, Strain Data time history

Raw  Filtered

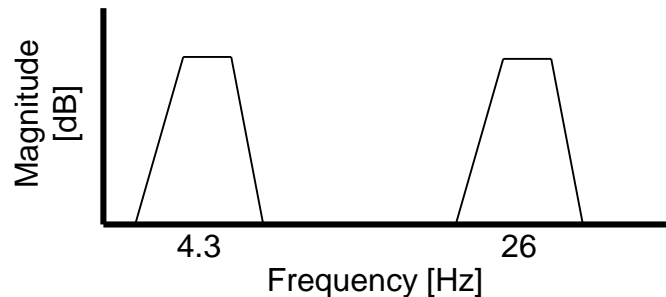
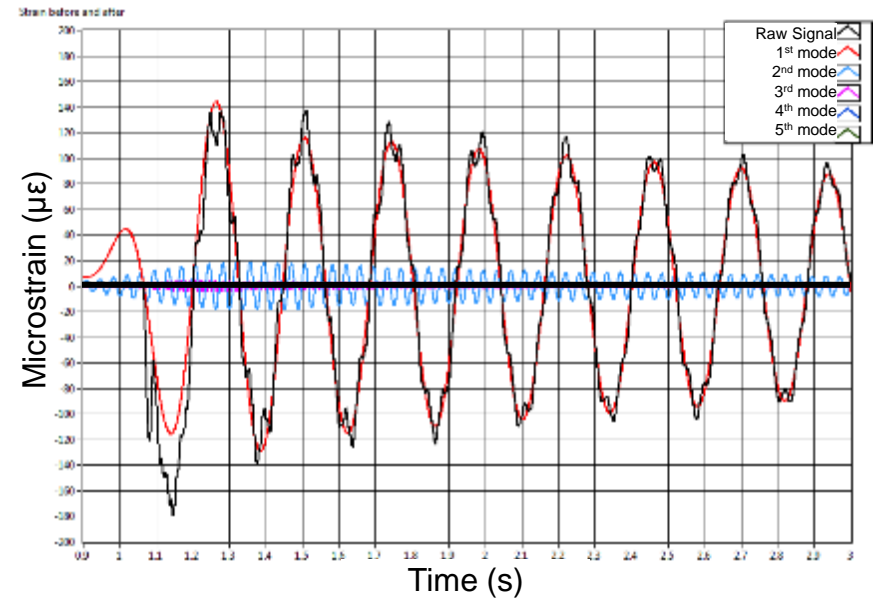
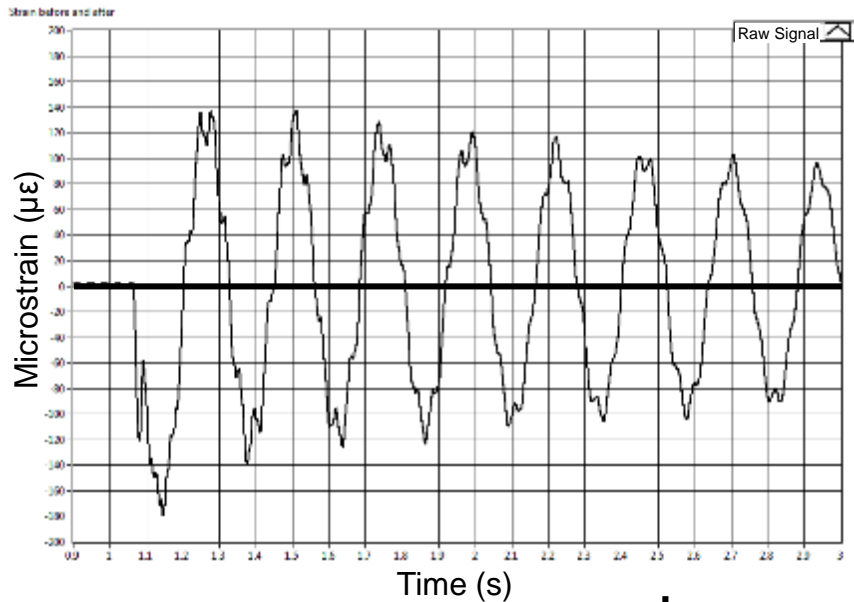

A NASA New Technology Report (NTR) has been filed for the Mode Shape and Acceleration Monitoring Method described in this technical presentation and is therefore patent protected. Those interested in using the method should contact the NASA Technology Transfer Program Office at NASA Armstrong Flight Research Center for more information

# Isolating Mode Shapes

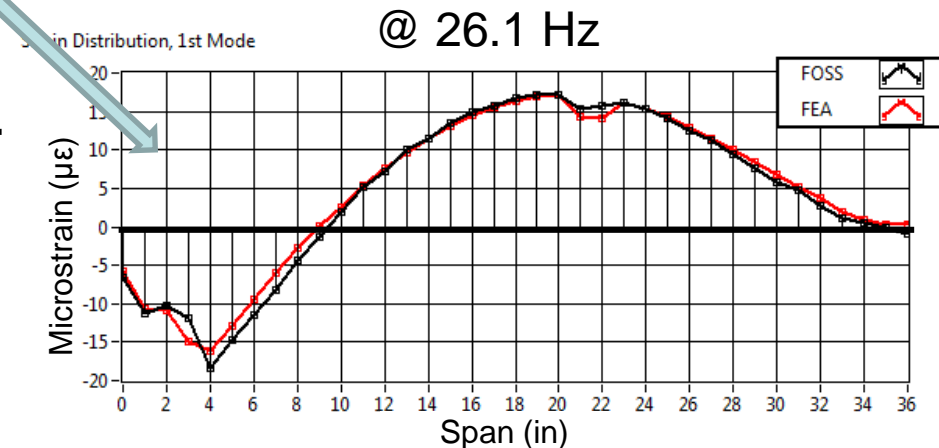
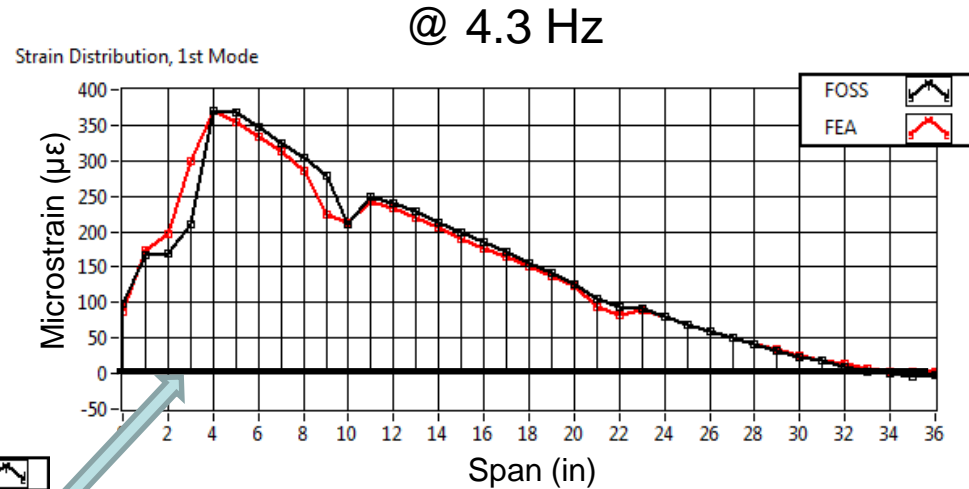
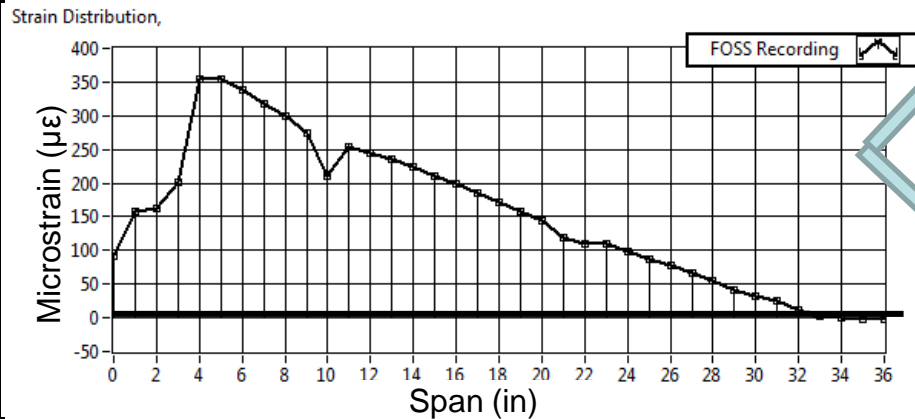
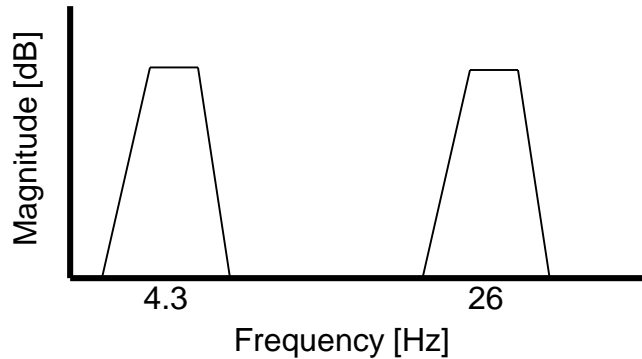

A NASA New Technology Report (NTR) has been filed for the Mode Shape and Acceleration Monitoring Method described in this technical presentation and is therefore patent protected. Those interested in using the method should contact the NASA Technology Transfer Program Office at NASA Armstrong Flight Research Center for more information

# 1<sup>st</sup> mode strain distribution (4 Hz)

Strain Distribution, 1st Mode

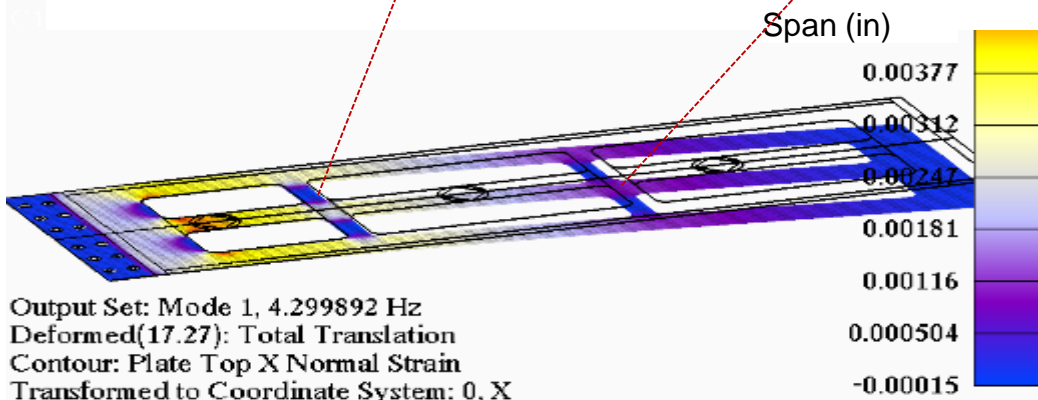
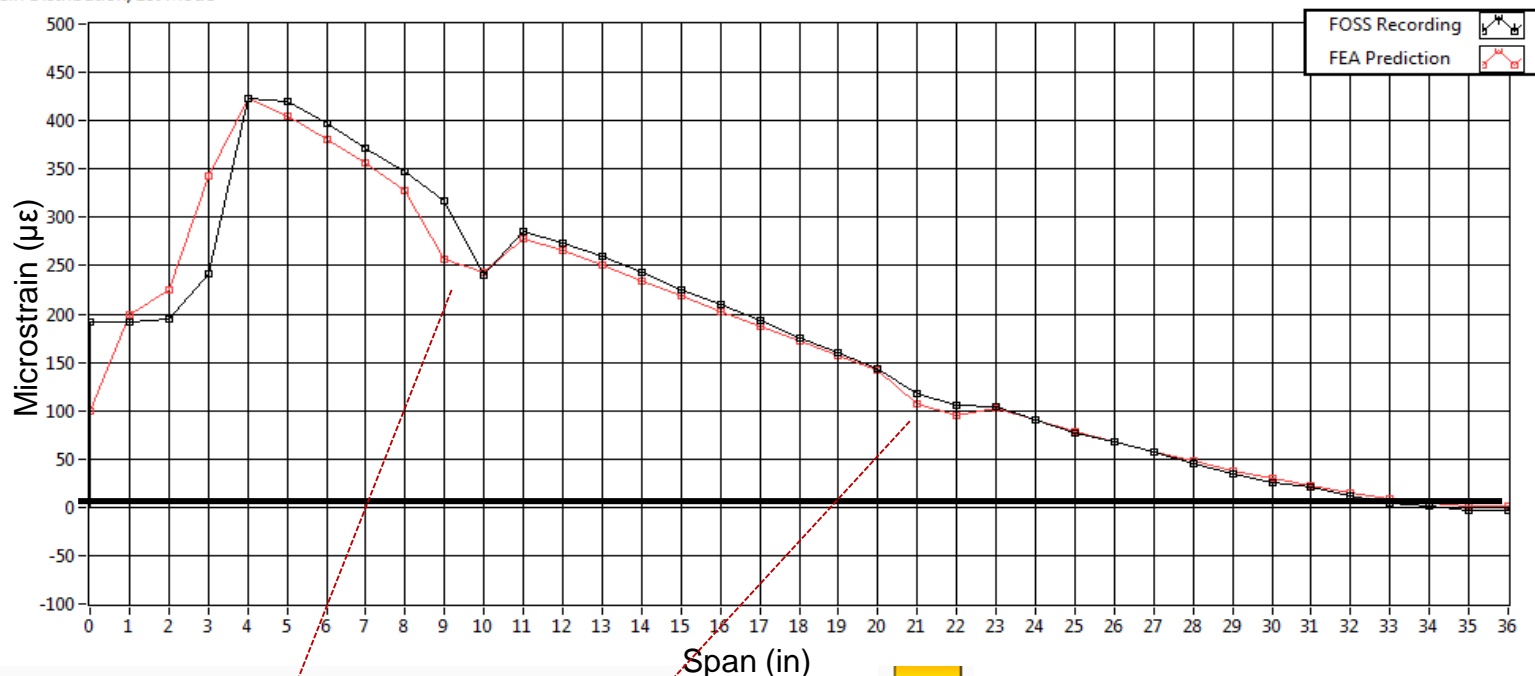

A NASA New Technology Report (NTR) has been filed for the Mode Shape and Acceleration Monitoring Method described in this technical presentation and is therefore patent protected. Those interested in using the method should contact the NASA Technology Transfer Program Office at NASA Armstrong Flight Research Center for more information

# 1<sup>st</sup> mode deflection comparisons (4 Hz)

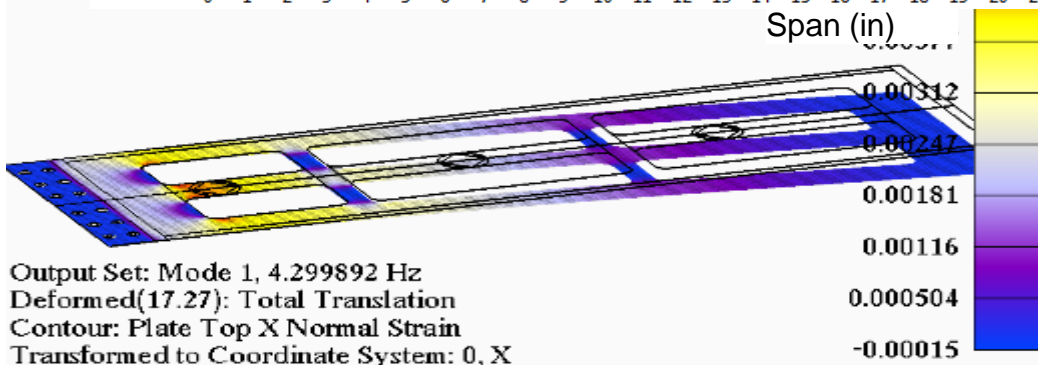
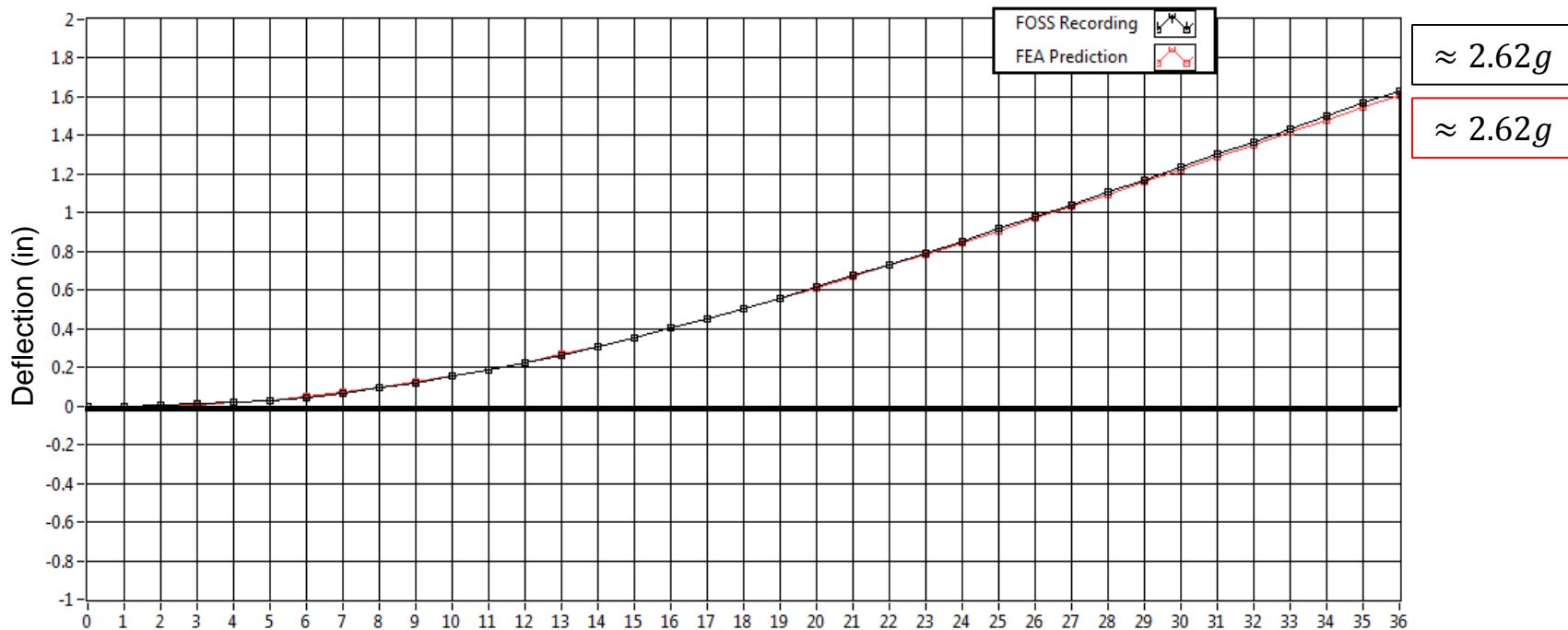

A NASA New Technology Report (NTR) has been filed for the Mode Shape and Acceleration Monitoring Method described in this technical presentation and is therefore patent protected. Those interested in using the method should contact the NASA Technology Transfer Program Office at NASA Armstrong Flight Research Center for more information

# 2<sup>nd</sup> mode strain distribution (26.5 Hz)

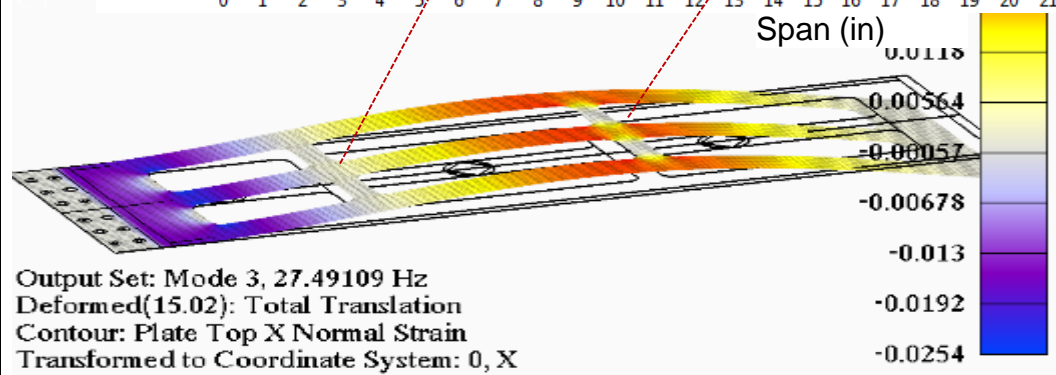
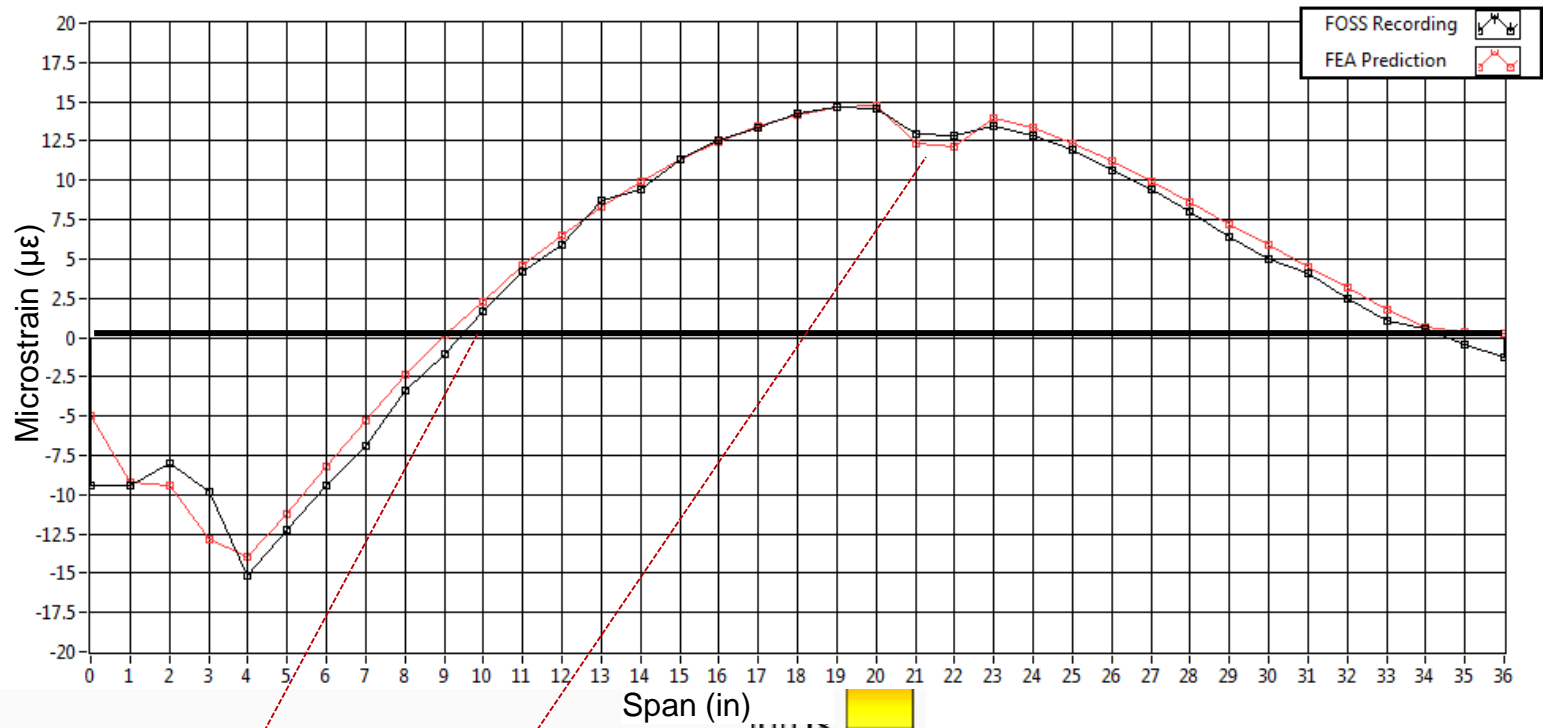

Output Set: Mode 3, 27.49109 Hz  
 Deformed(15.02): Total Translation  
 Contour: Plate Top X Normal Strain  
 Transformed to Coordinate System: 0, X

A NASA New Technology Report (NTR) has been filed for the Mode Shape and Acceleration Monitoring Method described in this technical presentation and is therefore patent protected. Those interested in using the method should contact the NASA Technology Transfer Program Office at NASA Armstrong Flight Research Center for more information

# 2<sup>nd</sup> mode deflection comparisons (26.5 Hz)

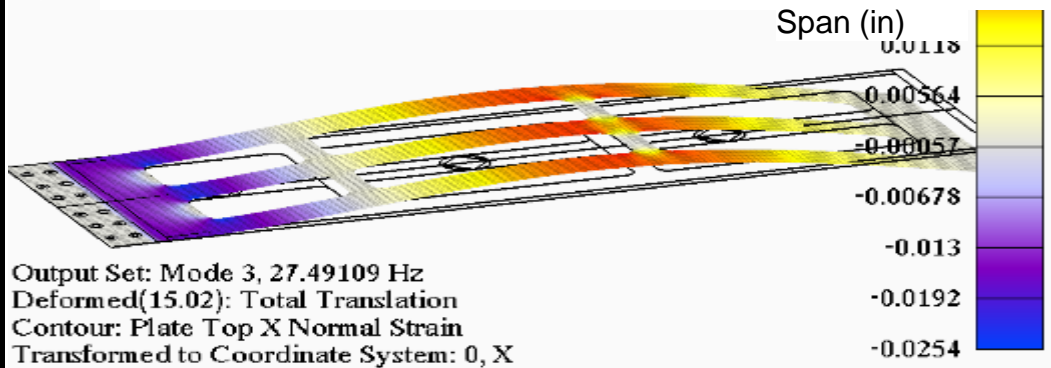
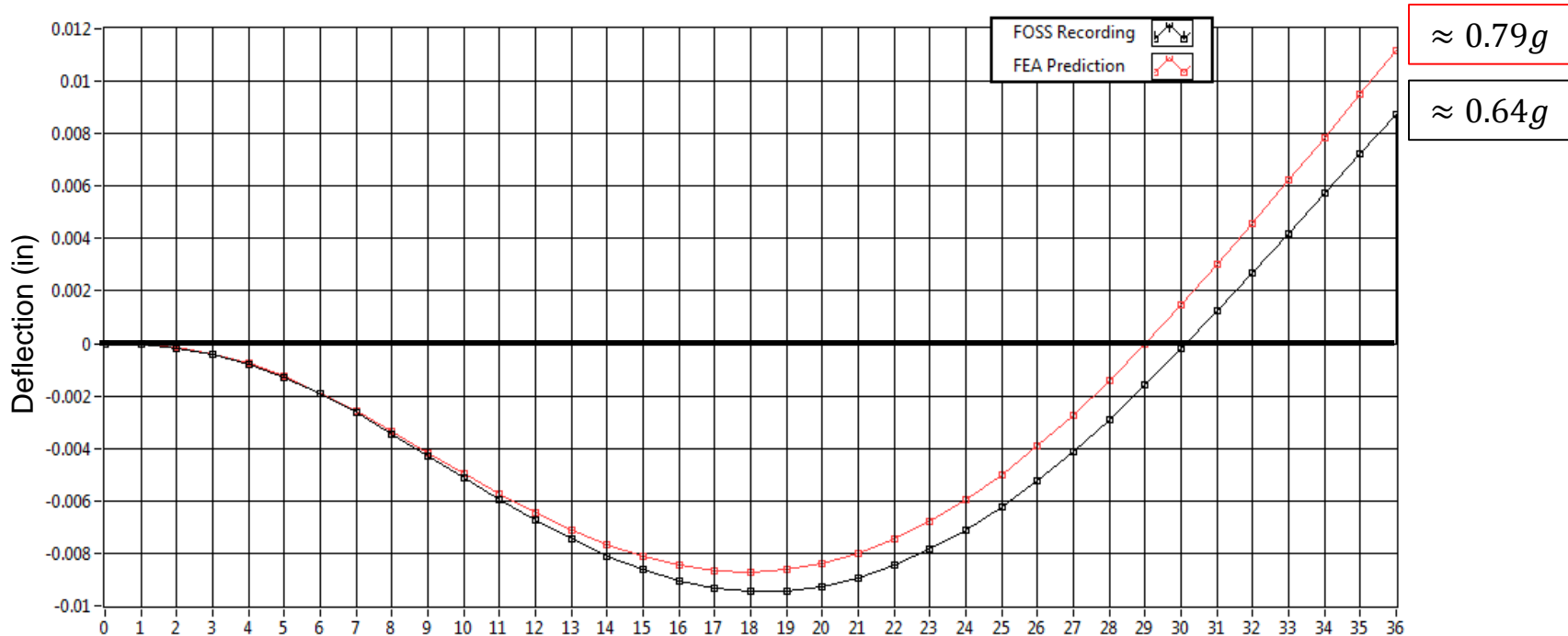

A NASA New Technology Report (NTR) has been filed for the Mode Shape and Acceleration Monitoring Method described in this technical presentation and is therefore patent protected. Those interested in using the method should contact the NASA Technology Transfer Program Office at NASA Armstrong Flight Research Center for more information

# Impact test, Accelerometer vs. High Speed Fiber Optics (5 modes) Test

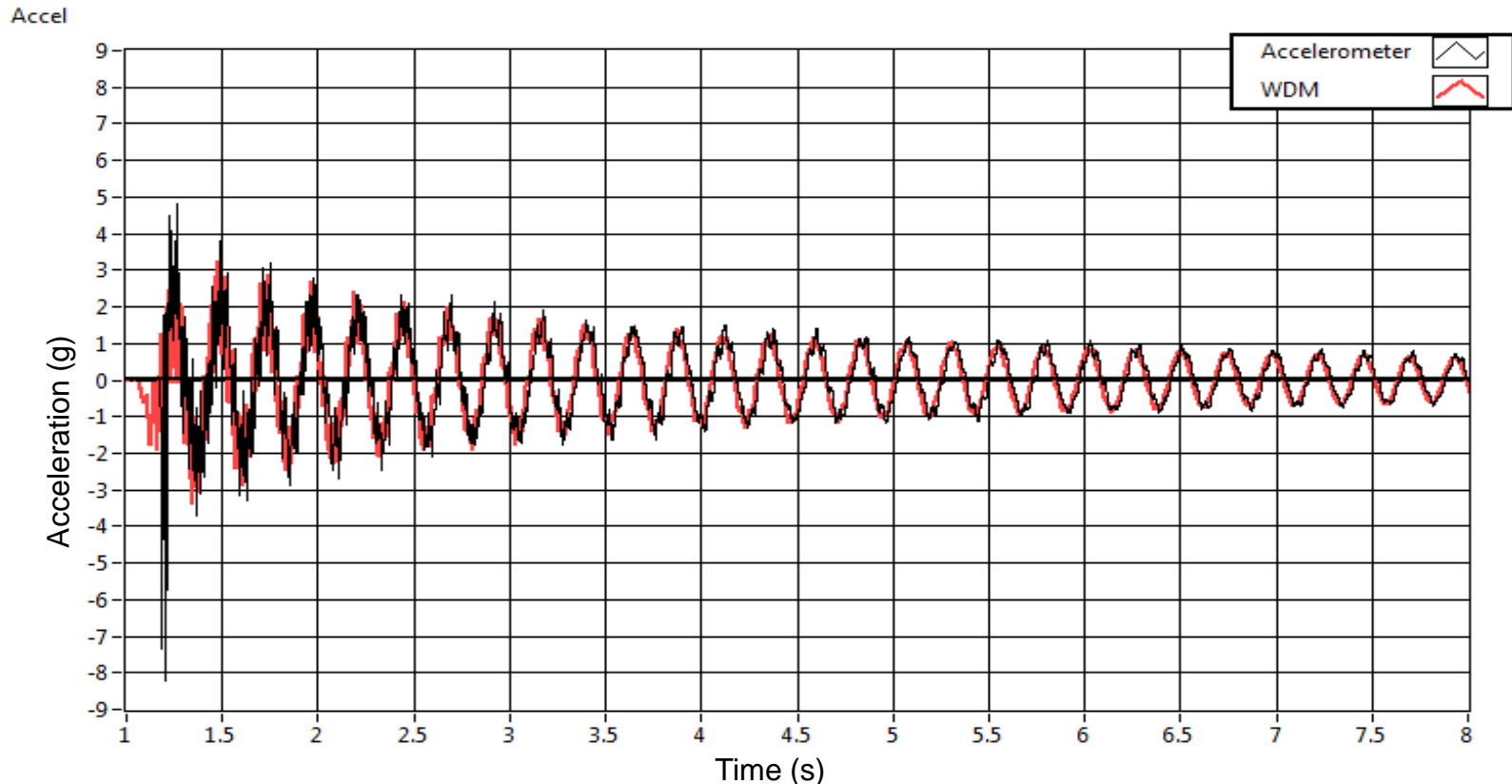

$$x = A_1 \cdot \sin(\omega_{n1}t + \phi_1) + A_2 \cdot \sin(\omega_{n2}t + \phi_2) \dots$$

$$\dot{x} = \omega_{n1} \cdot A_1 \cdot \cos(\omega_{n1}t + \phi_1) + \omega_{n2} \cdot A_2 \cdot \cos(\omega_{n2}t + \phi_2) \dots$$

$$\ddot{x} = -\omega_{n1}^2 \cdot A_1 \cdot \sin(\omega_{n1}t + \phi_1) - \omega_{n2}^2 \cdot A_2 \cdot \sin(\omega_{n2}t + \phi_2) \dots$$

A NASA New Technology Report (NTR) has been filed for the Mode Shape and Acceleration Monitoring Method described in this technical presentation and is therefore patent protected. Those interested in using the method should contact the NASA Technology Transfer Program Office at NASA Armstrong Flight Research Center for more information



# Anticipated Impact of Fiber Optic based SHM

- **Potential to revolutionize aerospace design and performance throughout the vehicle life-cycle**
  - Design and development
  - Fabrication
  - Test and Evaluation
  - In-flight operation
  - Off-nominal flight
  - End of life-cycle decisions



# Concluding Remarks

---

- **FOSS Benefits**
  - Provides >100x the number measurements at 1/100 the total sensor weight
  - Increases capability of measuring multiple parameters in real time (strain, temp., accel, liquid level, shape, applied loads, stress, mode shapes, natural frequencies, buckling modes, etc.)
  - Provides comprehensive datasets to validate loads / dynamics models
- **For most full-scale structural dynamics applications, FOSS sample rates (16,000 sensors at 100sps) are sufficient**
- **A single hybrid interrogation scheme that gleans the benefits of two different FBG sensing technologies, WDM and OFDR, has been developed and demonstrated**
  - OFDR acquires higher density FOSS measurements (16,000) and lower speed (100Hz)
  - WDM acquires FOSS measurements at higher speed (35kHz) and lower density (~80/fiber)
- **FOSS has the potential to “break the rules” for DFI; it can be used throughout loads/dynamics modeling effort (from ground to flight) by providing an unprecedented understanding about system/structural performance of LV/SC throughout the vehicle life cycle**

---

# ***Extra Slides***

# Fiber Bragg Gratings (FBGs)

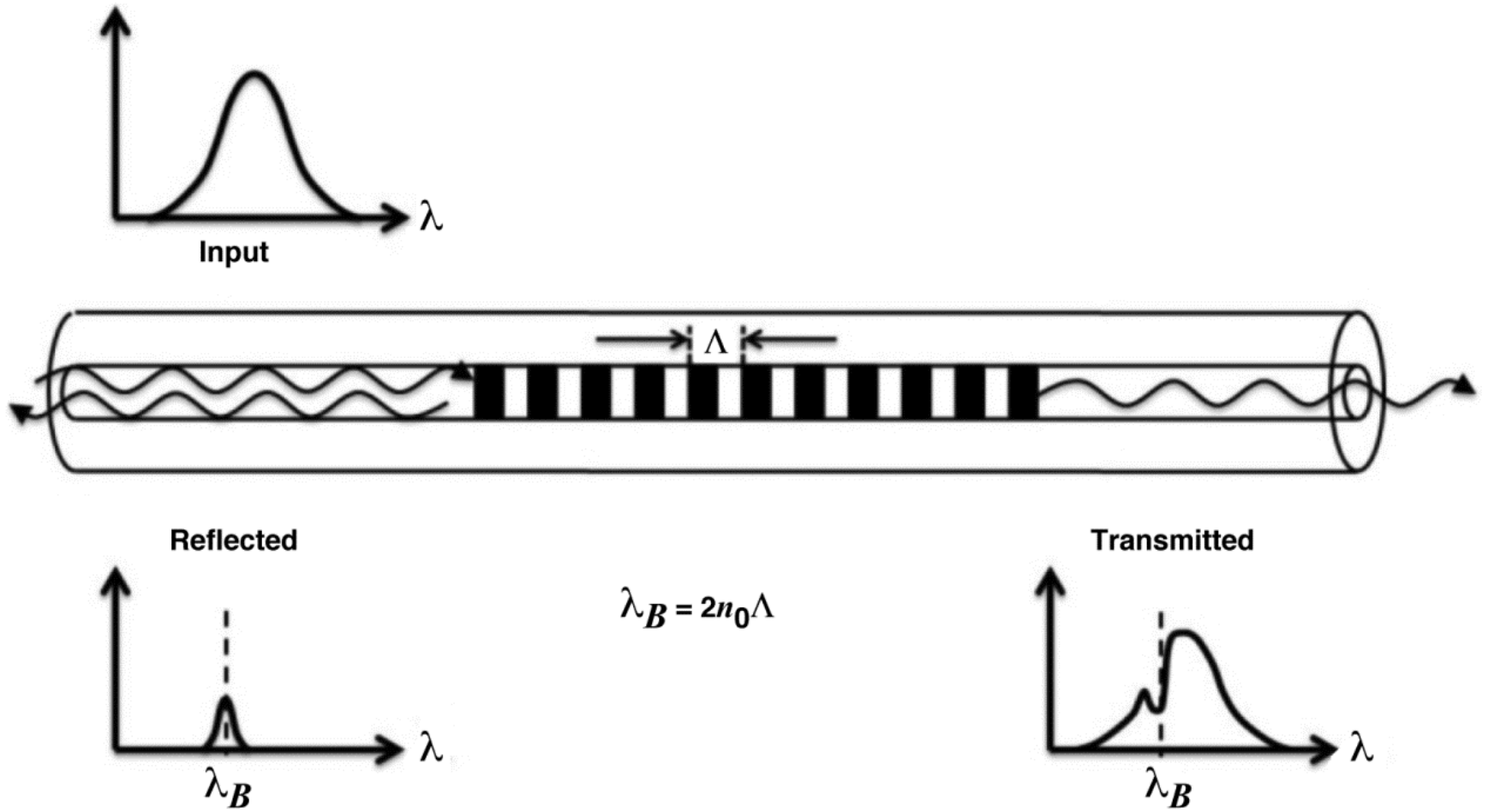

# OFDR

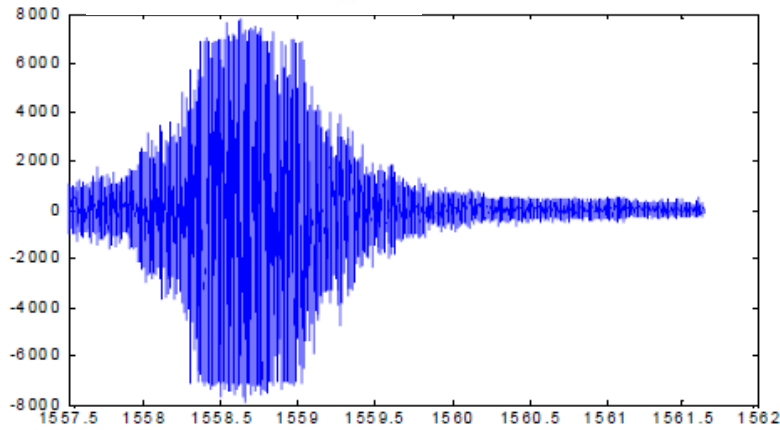
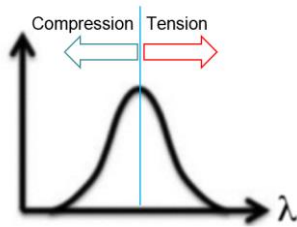
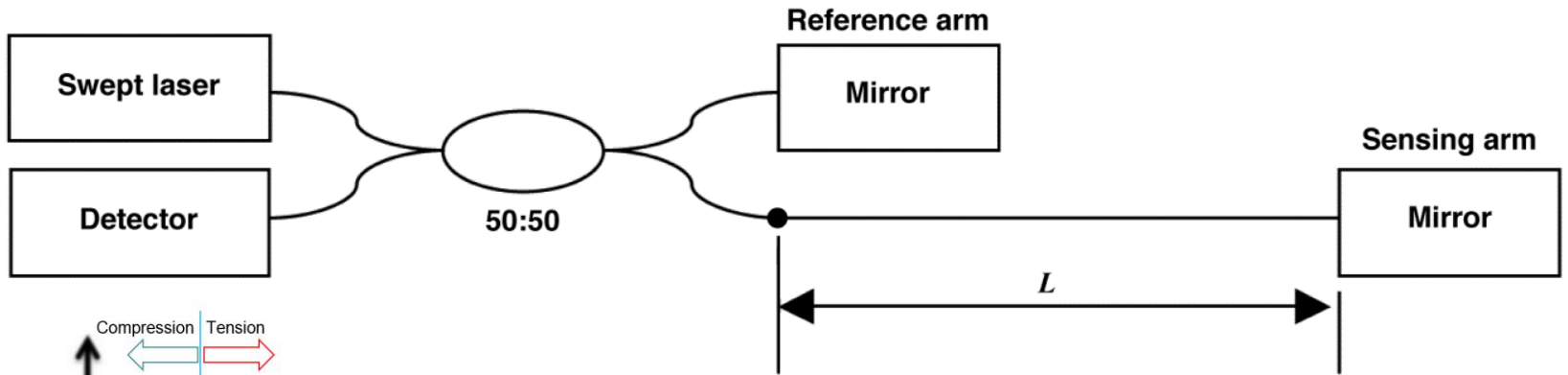

FFT

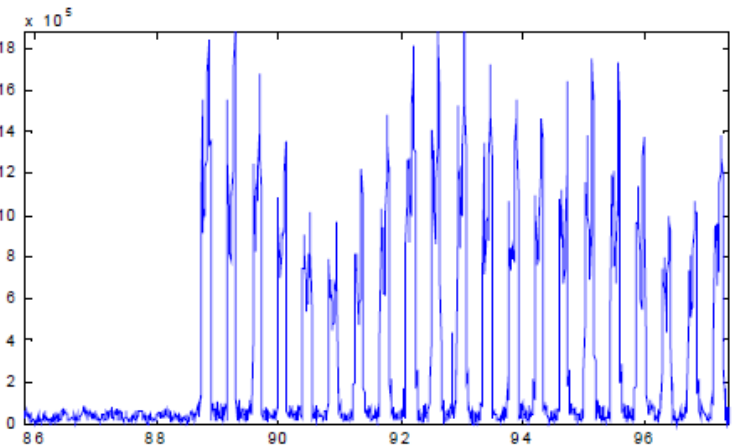

Wavelength ( $\lambda$ ) domain

Length ( $L$ ) domain

# WDM

