

Solar Thermal Propulsion at MSFC

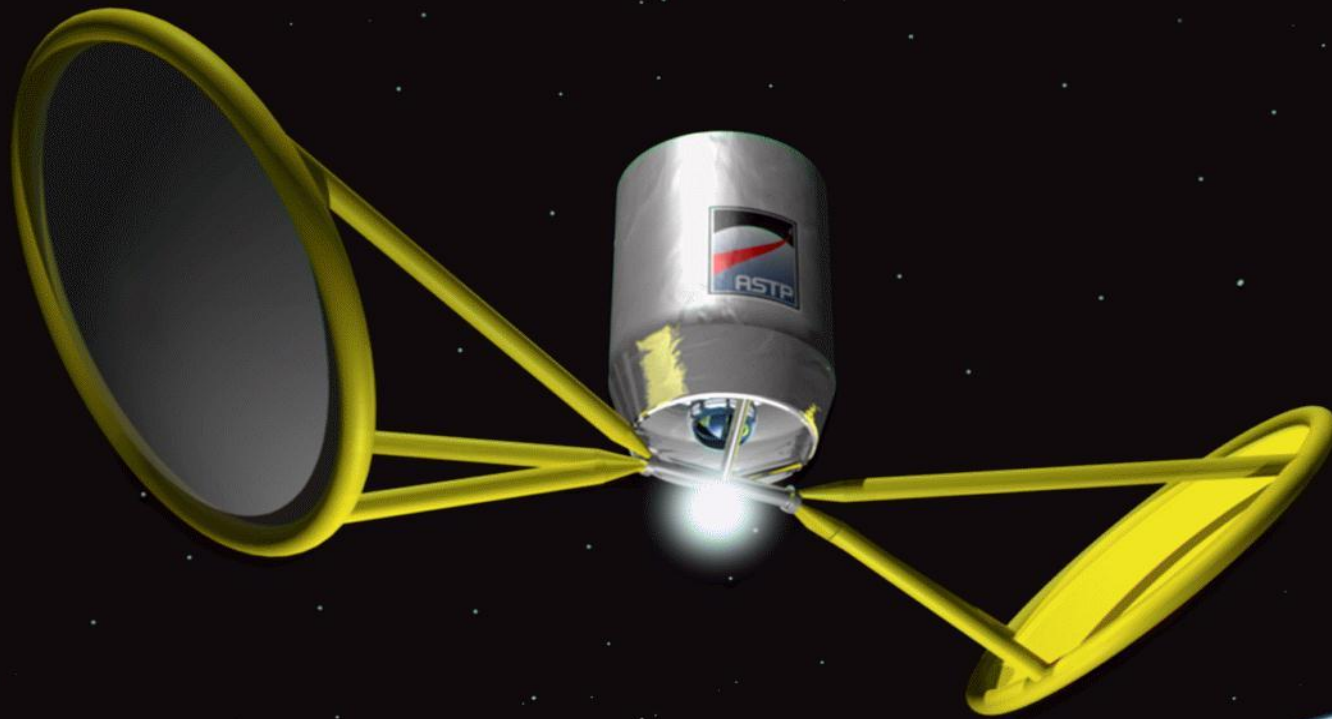

Harold P. Gerrish Jr.
Propulsion Systems Division
Marshall Space Flight Center
February 3, 2016

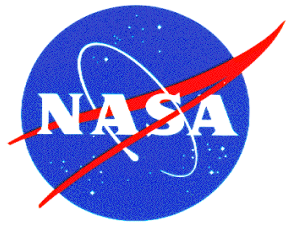

Agenda

- What is Solar Thermal Propulsion (STP)?
- Past Major STP Programs
- In-house Direct Gain Thruster
- MSFC STP Facility
- Other Subsystems
- Why STP Lost Momentum?
- Recommendations

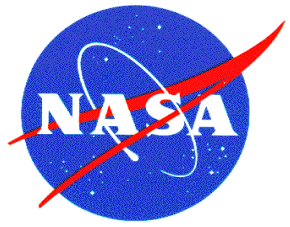

Solar (Fusion) Energy

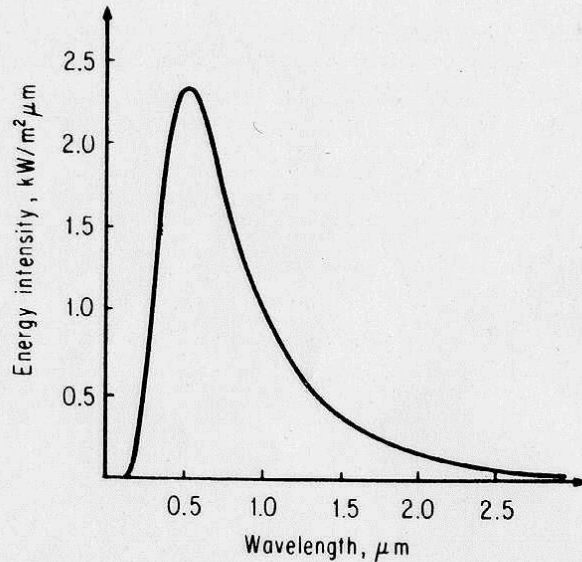

Spectral distribution of extraterrestrial solar radiation.

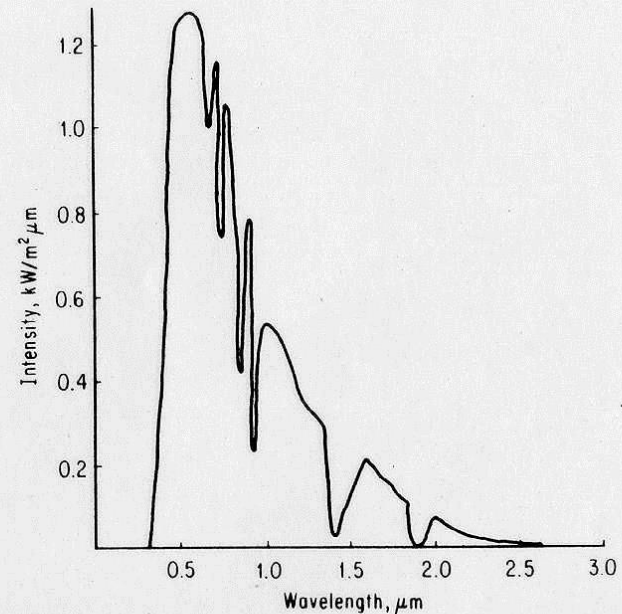

Approximate spectral distribution of solar radiation on earth with an air mass 2 atm.

- Solar Flux Intensity at Low Earth Orbit $\sim 1400 \text{ W/m}^2$
- Solar Flux Intensity at Mars $\sim 619 \text{ W/m}^2$
- Solar Flux Intensity at Huntsville, AL $\sim 1000 \text{ W/m}^2$ max

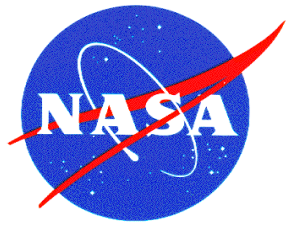

Solar Thermal Propulsion (STP)



CREDIT: NORTH AMERICAN ROCKWELL

Solar Thermal Propulsion
conceived in 1956 by Krafft Ehricke

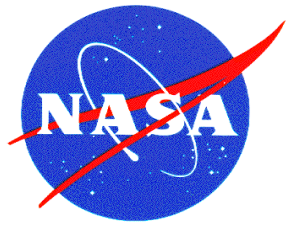

How Does STP Work?

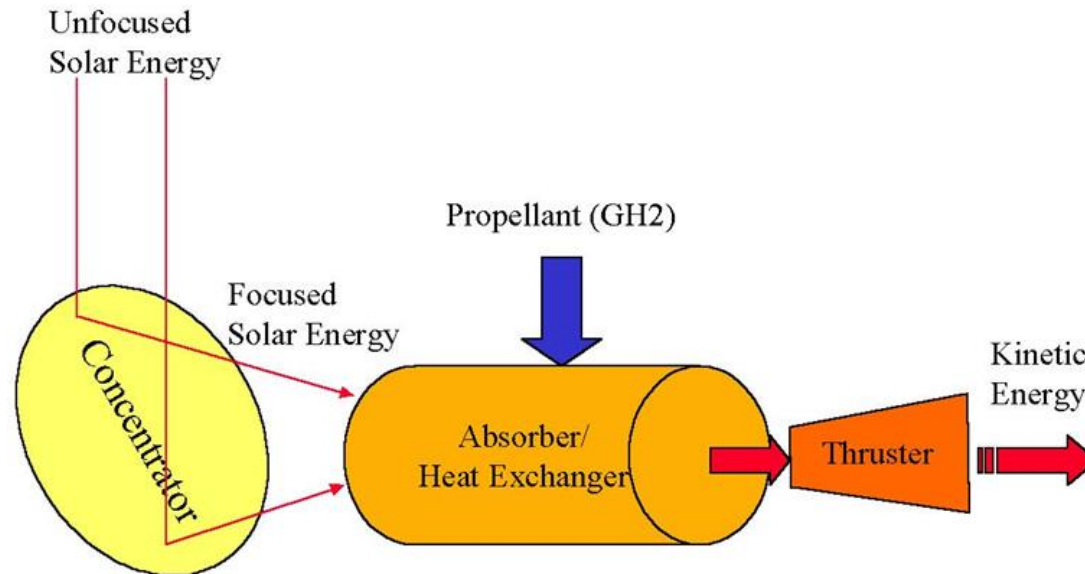

- Solar energy is collected via a concentrator (reflector or fresnel lens) and focused inside an absorber cavity
- The hot absorber cavity transfers heat to the propellant
- The hot propellant thermally expands in a conical nozzle

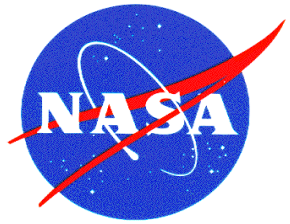

Space Propulsion Concepts

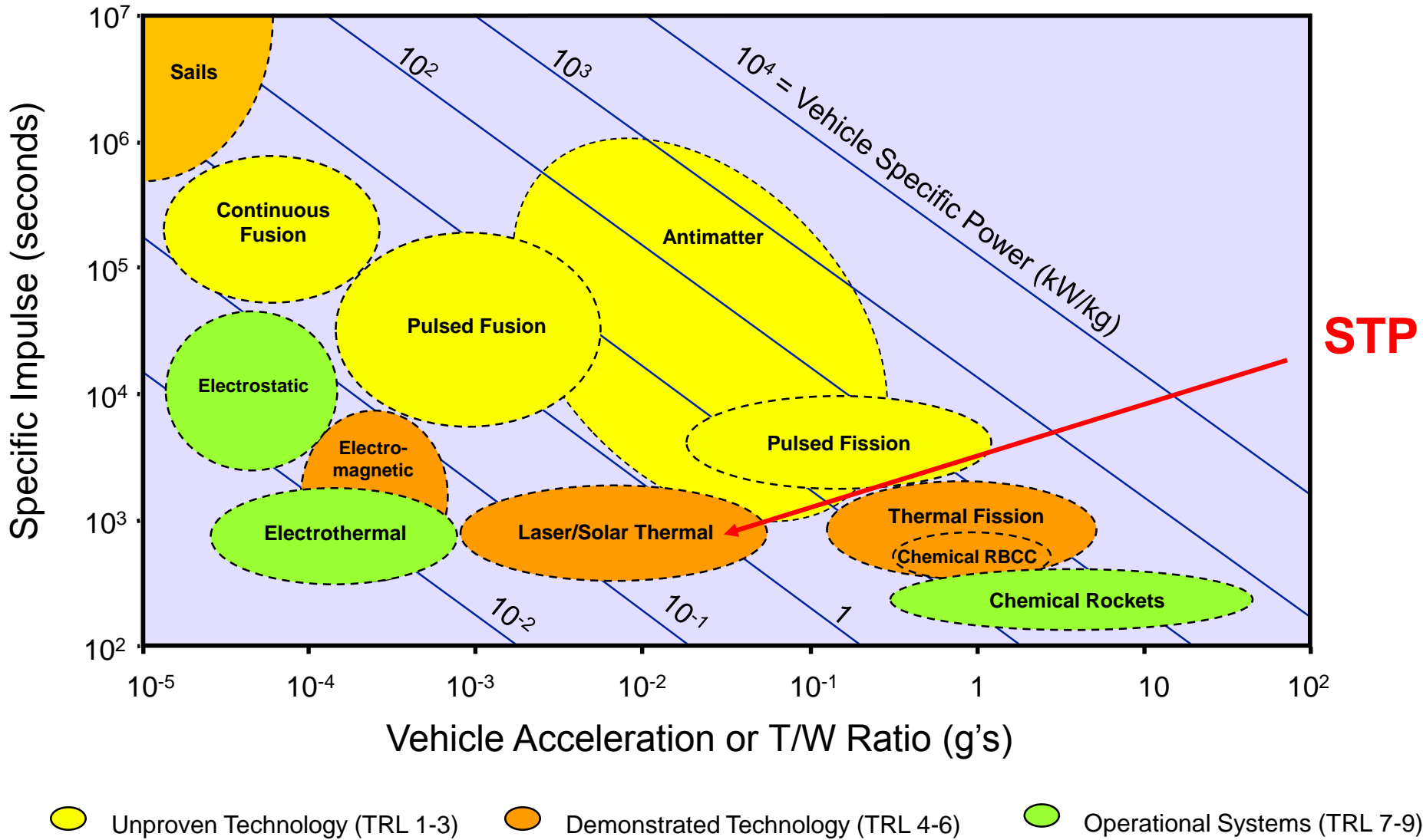

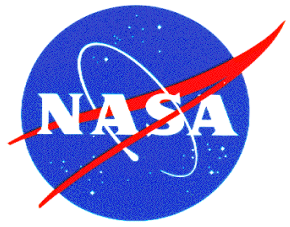

Solar Thermal Thruster (Rocketdyne)

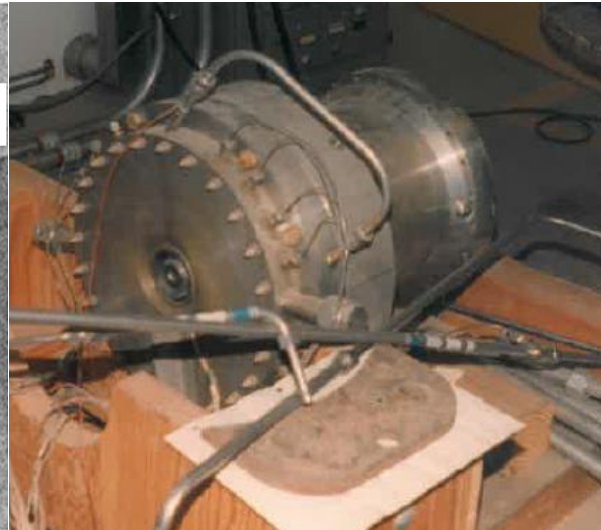
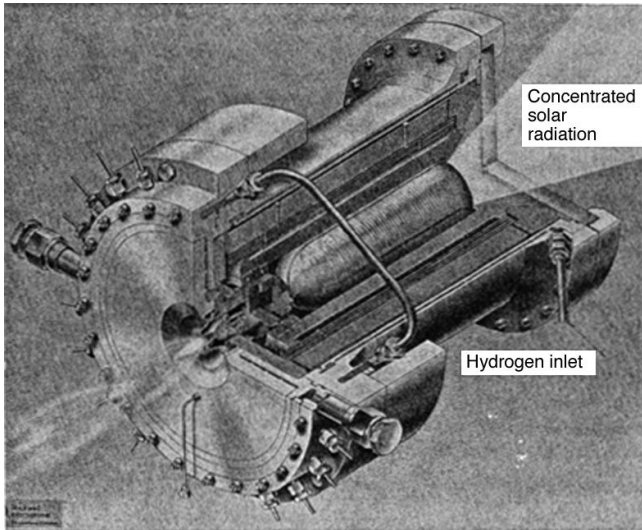

NASA SP-509 vol 2

- Air Force sponsored project in the late 1980's
- Rhenium absorber cavity designed to heat hydrogen to 2700K and provide .83 lbf of thrust and 7900 m/sec exhaust velocity
- Tested at AF Phillips Lab (now AFRL) for ~65 hours

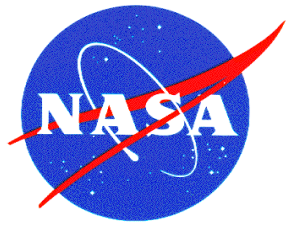

STP History at MSFC

- As the NASA Space Exploration Initiative (SEI) program was closing down in 1993, MSFC investigated a STP proposal from Hercules.
- A more in-depth feasibility study was done by MSFC in 1994 to determine both the technical and economic feasibility of a Solar Thermal Upper Stage.

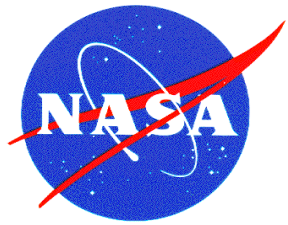

Solar Thermal Upper Stage

Ground Rules

- Thrust = 2 lbf
- Specific impulse I_{sp} = 860 sec with hydrogen
- Total # of burns = 155 (includes apogee and perigee)
- Engine inlet total pressure = 25 psia provided by hydrogen boil-off
- Off-axis inflatable concentrators

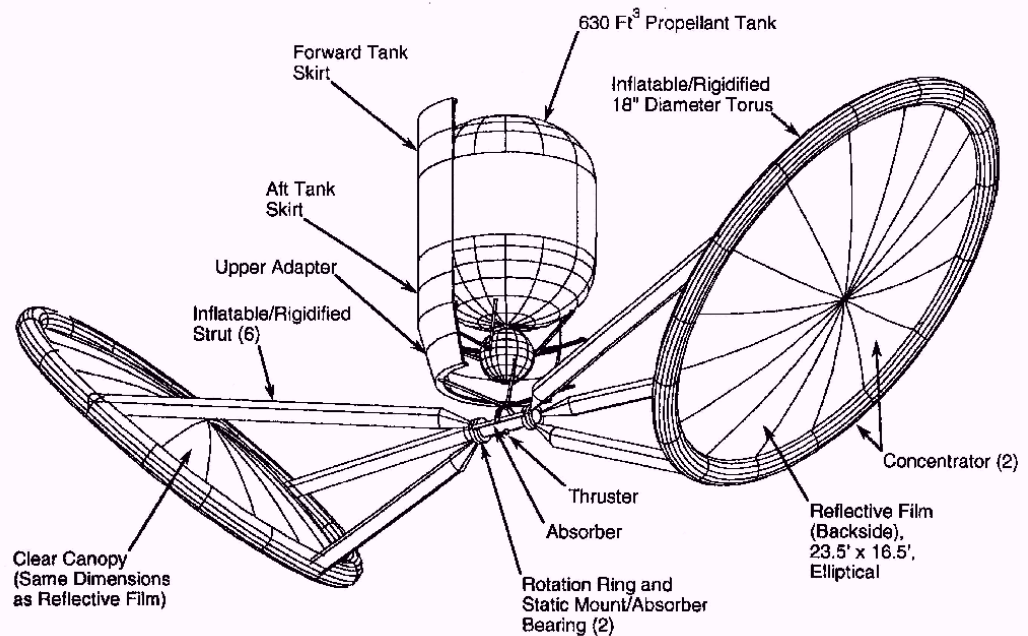

NASA TM-111062

- 30-day orbit transfer of 1000 lbs payload from low earth orbit to geosynchronous
- Allows greater initial mass in low earth orbit than traditional chemical upperstages
- Future use as orbital maneuvering vehicle for satellites
- Design simplicity leads to lower development cost
- Technologies can be used with other propulsion concepts
- Primary concern is propellant volume required. Higher I_{sp} reduces volume.

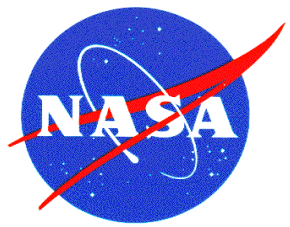

STP Operation in Orbit

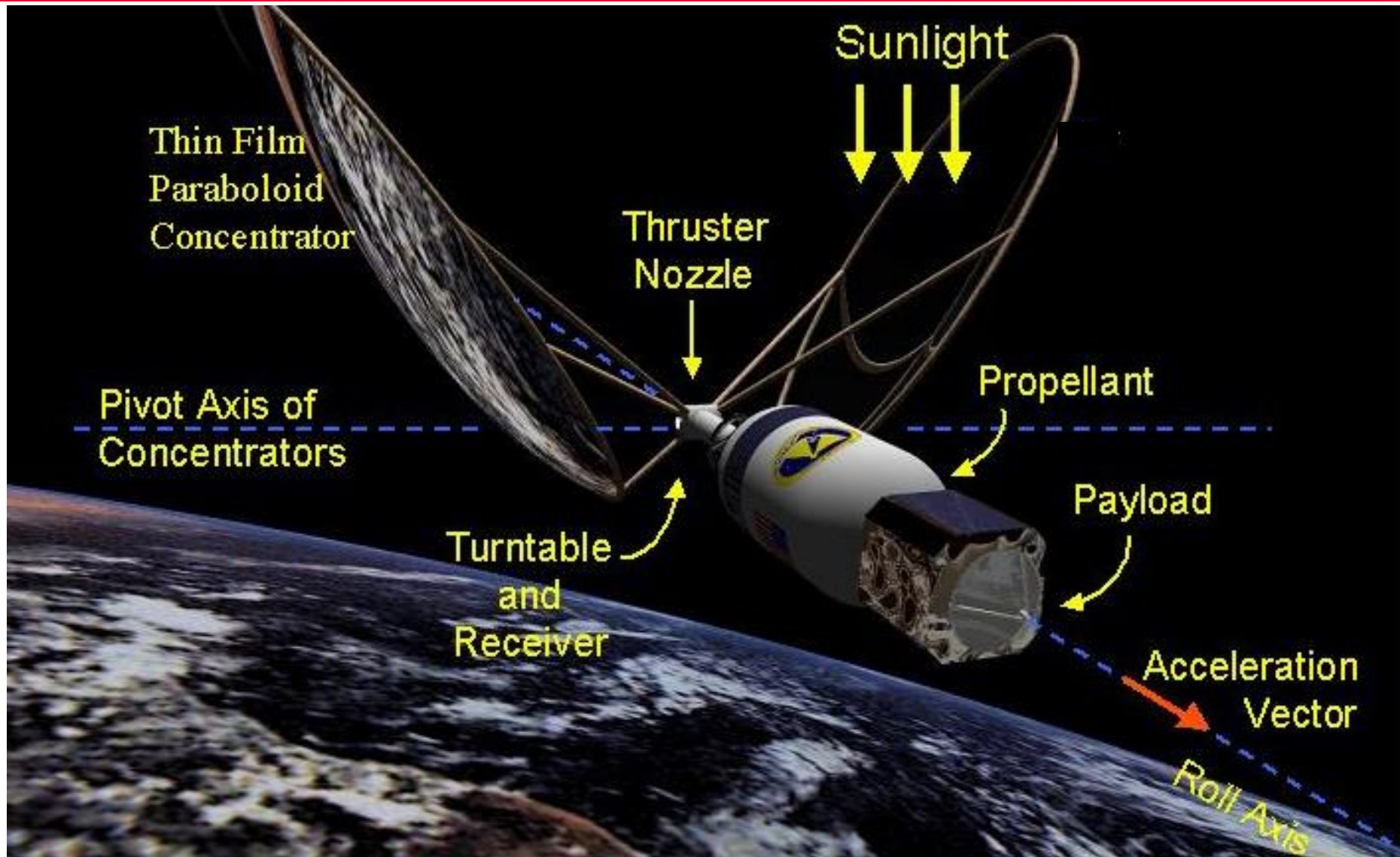

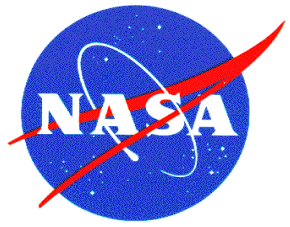

Shooting Star Experiment

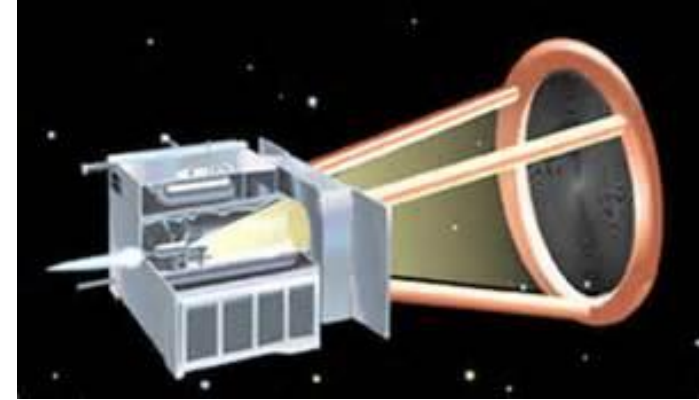
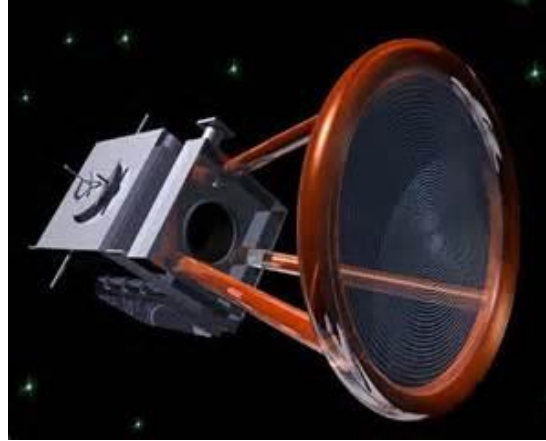

- Solar Thermal Flight Experiment “Shooting Star” MSFC project 1996-2000
- Spartan 208 mission to test an inflatable structural system, freznel lens, and thermal storage thruster
- Rhenium engine with a foam heat exchanger providing .5 lbf of thrust and $I_{sp} \sim 700$ sec.
- Freznel lens made of polyimide film with a 3000:1 concentration ratio



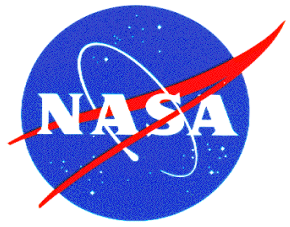

Air Force Research Lab STP Facility



- MSFC worked closely with colleagues at AFRL STP Facility
- Facility used for NASA AITP testing
- Test chamber used nitrogen ejector to provide high altitude ambient conditions ~1psi for open cycle thruster tests

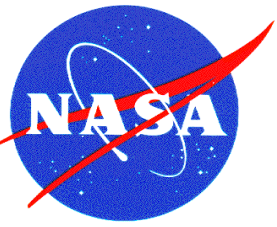

Solar Thermal Upper Stage Technology Demonstrator

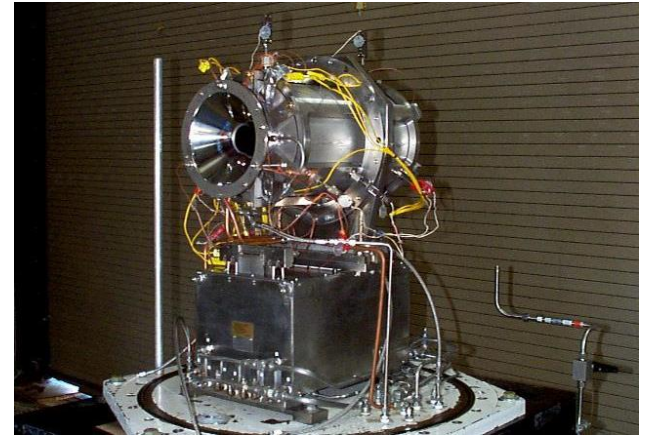

- One of several NASA Aerospace Industry Technology Program (AITP) contracts. 1995-1999
- Led by Boeing (then MDA), UAT, Thiokol, UAH, NASA-MSFC, NASA-GRC, and AFRL.
- Integrate flight type concentrator with absorber/thruster at AFRL and simultaneously test a flight type LH2 tank with innovative feed system concepts simulating a 30-day mission at MSFC.
- Limited performance of 12' diameter inflatable concentrator limited performance of thruster. The MDA cryogenic storage and feed system concept was proven.
- NASA-MSFC Cooperative agreement NCC-8-61. MDC 99H0078 final report

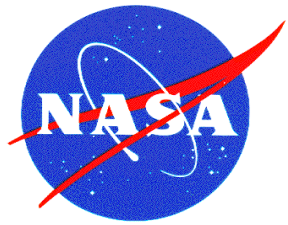

Major Air Force STP Programs

Integrated Solar Upper Stage (ISUS) mid 1990's

- Vehicle demonstrating solar bimodal power and propulsion
- ISUS functions as an upper stage then remains with satellite providing electric power for life of spacecraft
- Thrust~22 lbf and Isp~800 seconds
- Electric power via thermionic power conversion using solar receiver/absorber
- AIAA 95-3628



Solar Orbit Transfer Vehicle (SOTV) 1998-early 2000's

- Subscale demonstrator, including orbit transfer and plane change maneuvers, a solar bimodal system in the relevant space environment
- Integrates lessons learned from other STP projects (e.g., ISUS ground demo, STUSTD)
- Boeing, Thiokol, and SRS

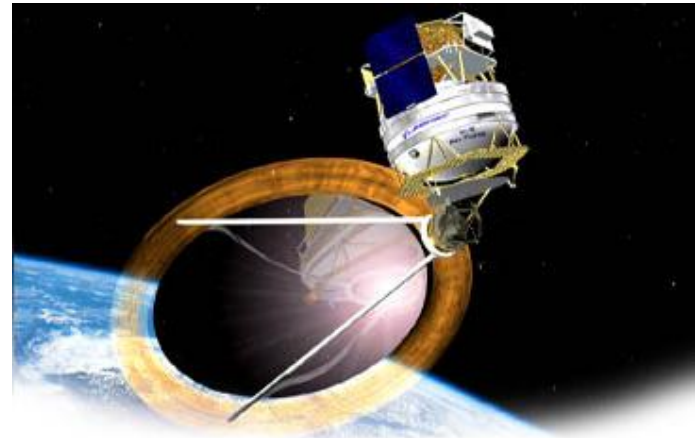

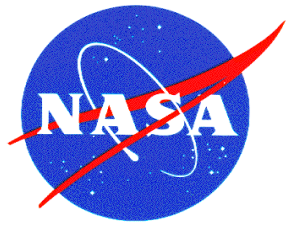

L'Garde Flight Experiment



- 1996 L'Garde Inflatable Antenna Experiment (IAE) seen from STS-77.
- Deployed from the space shuttle using a Spartan carrier spacecraft
- 14 meter diameter antenna
- Successful deployment, no entanglement

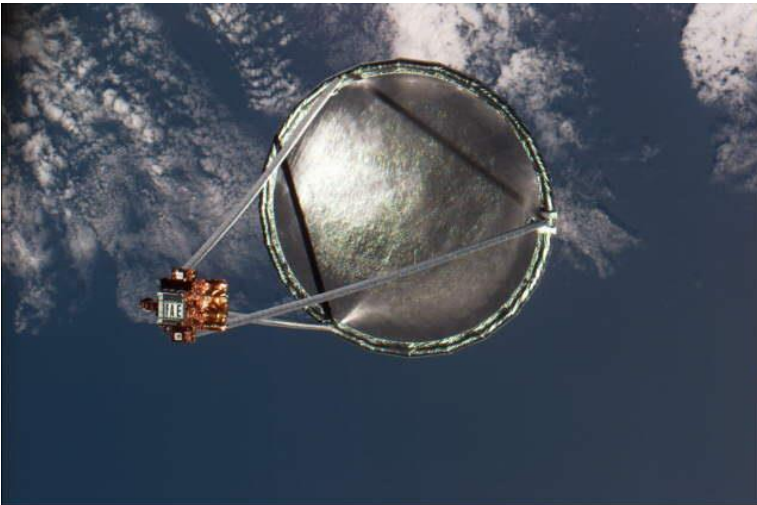

S77E5022 1996:05:20 08:04:38

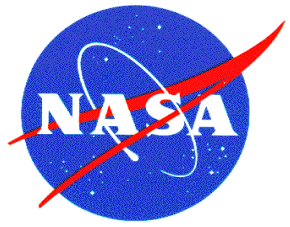

Types Of STP Engines Investigated at MSFC

Direct Gain Engine

- Engine operates directly with focused sunlight
- Requires larger concentrators for more power
- Does not function in earth shadow
- Capable of very high temperatures and higher Isp with critical joints at low temperatures

Storage Engine

- Engine stores heat in reservoir for later propulsion use, even in shadow
- Smaller concentrator than direct gain
- Can shorten trip times with slightly greater thrust
- More reaction control system propellant required
- Lower Isp than direct gain due to temperature constraints

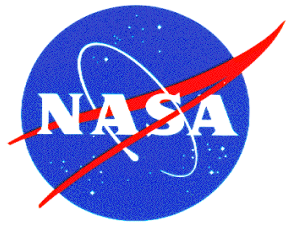

Melting Points of Various Materials

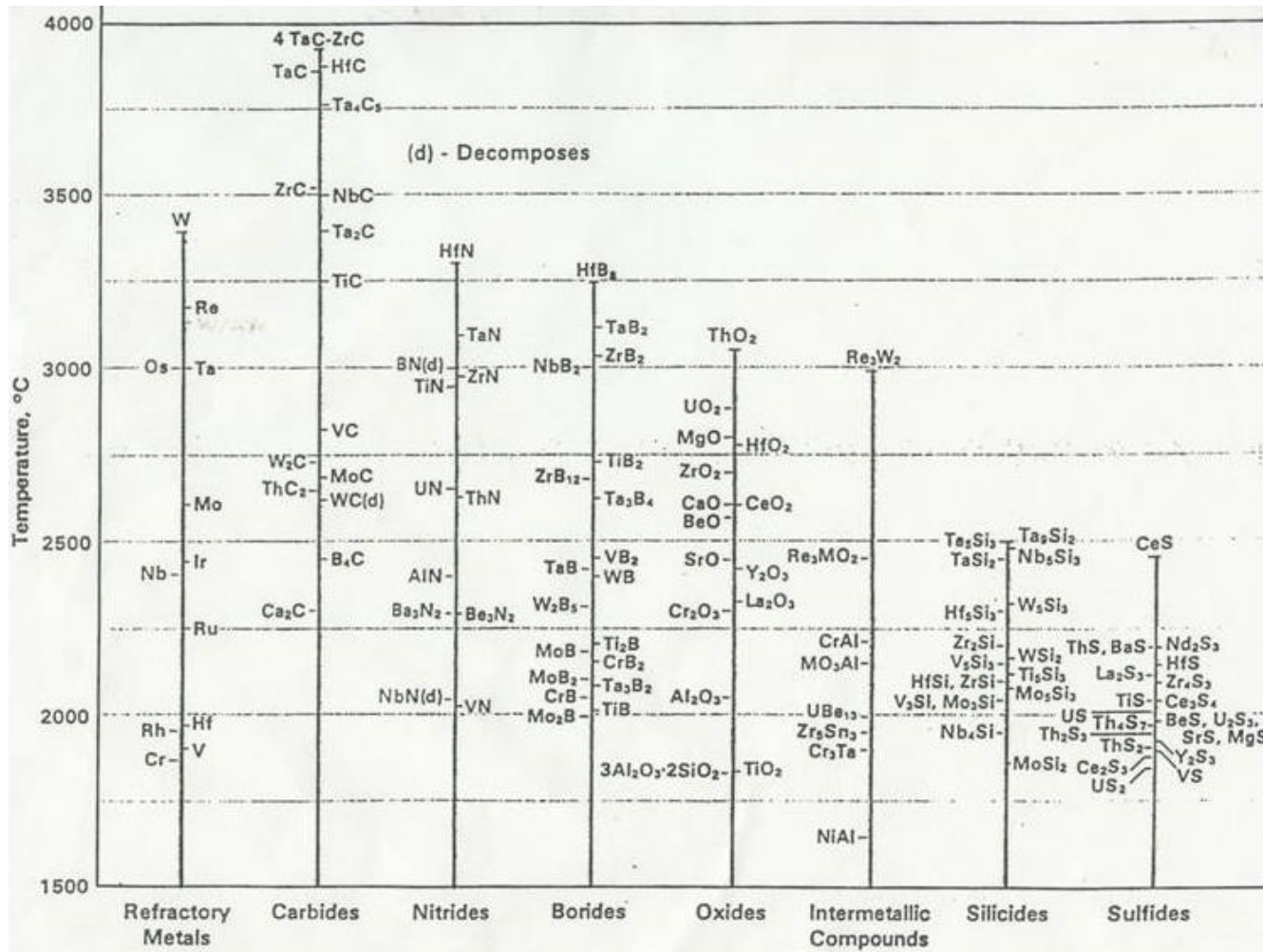

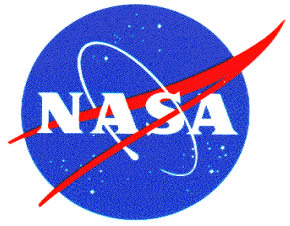

In-house MSFC STP project focused on direct gain thruster designs and a high altitude ground test facility

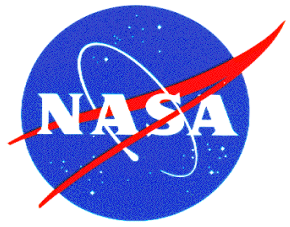

STP Direct Gain Assembly

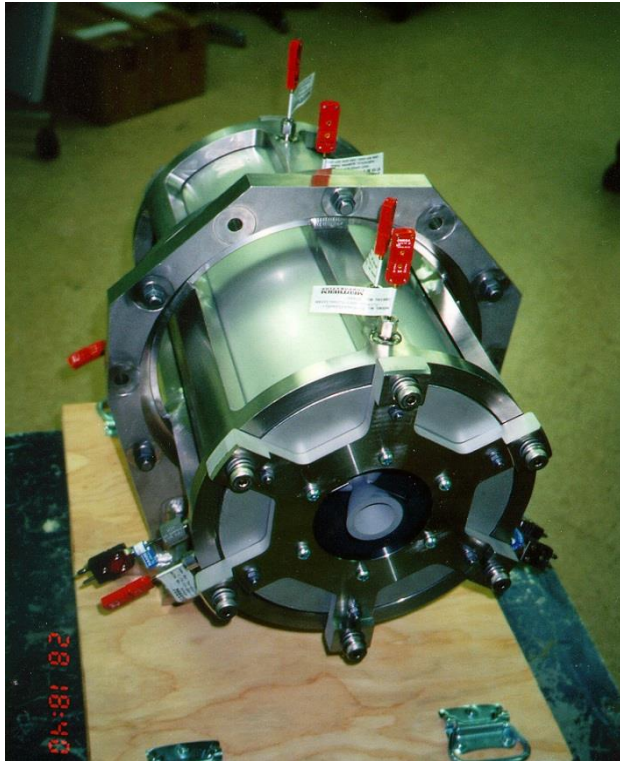

- .5 lbf thrust
- 2 lbs/hr flow rate hydrogen
- 10 kW solar power input

Solar Thermal Thruster STP-1

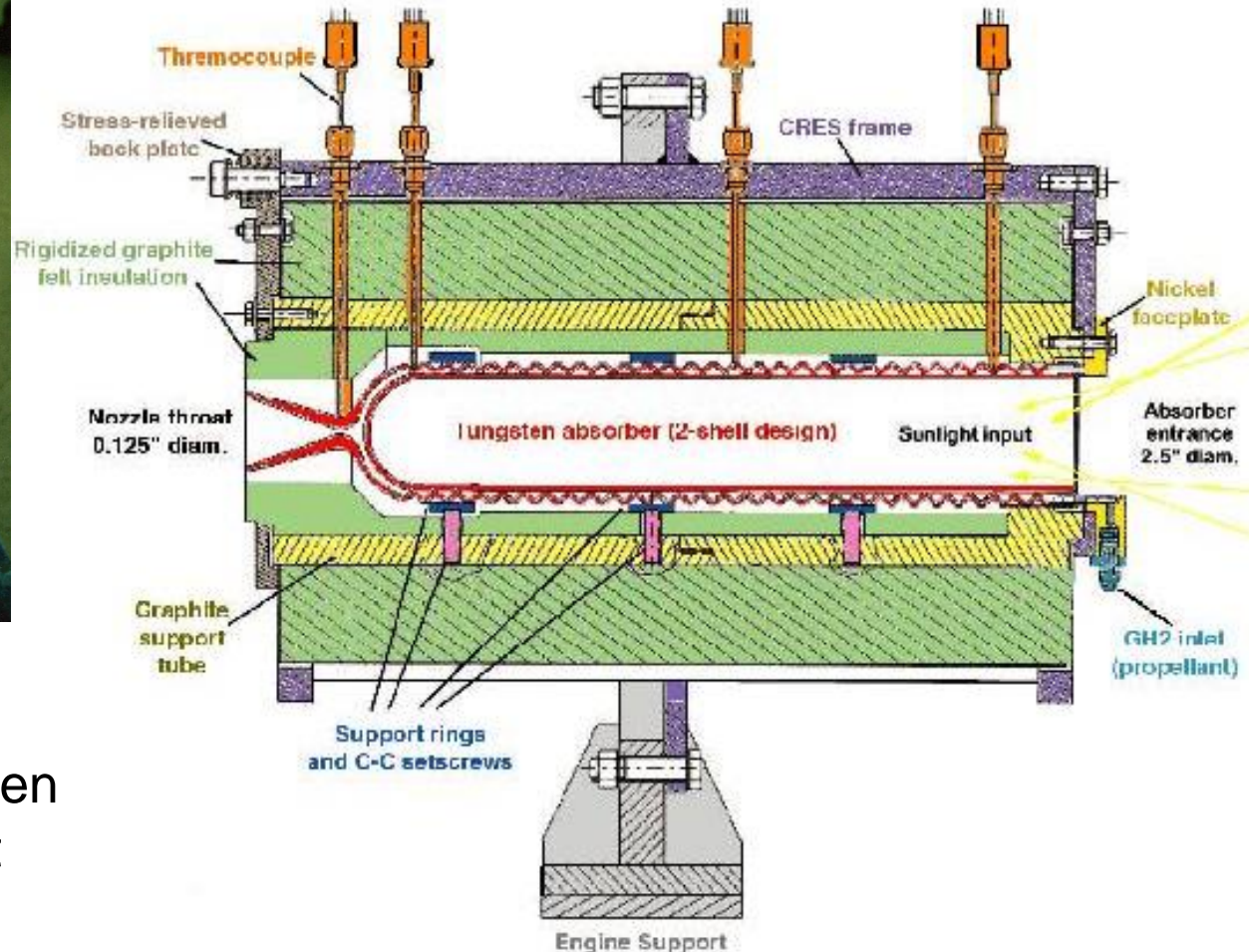

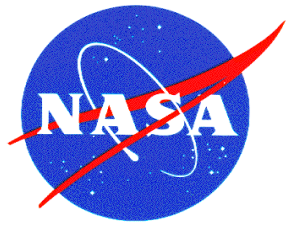

STP Direct Gain Components

Solar Thermal Thruster STT-1

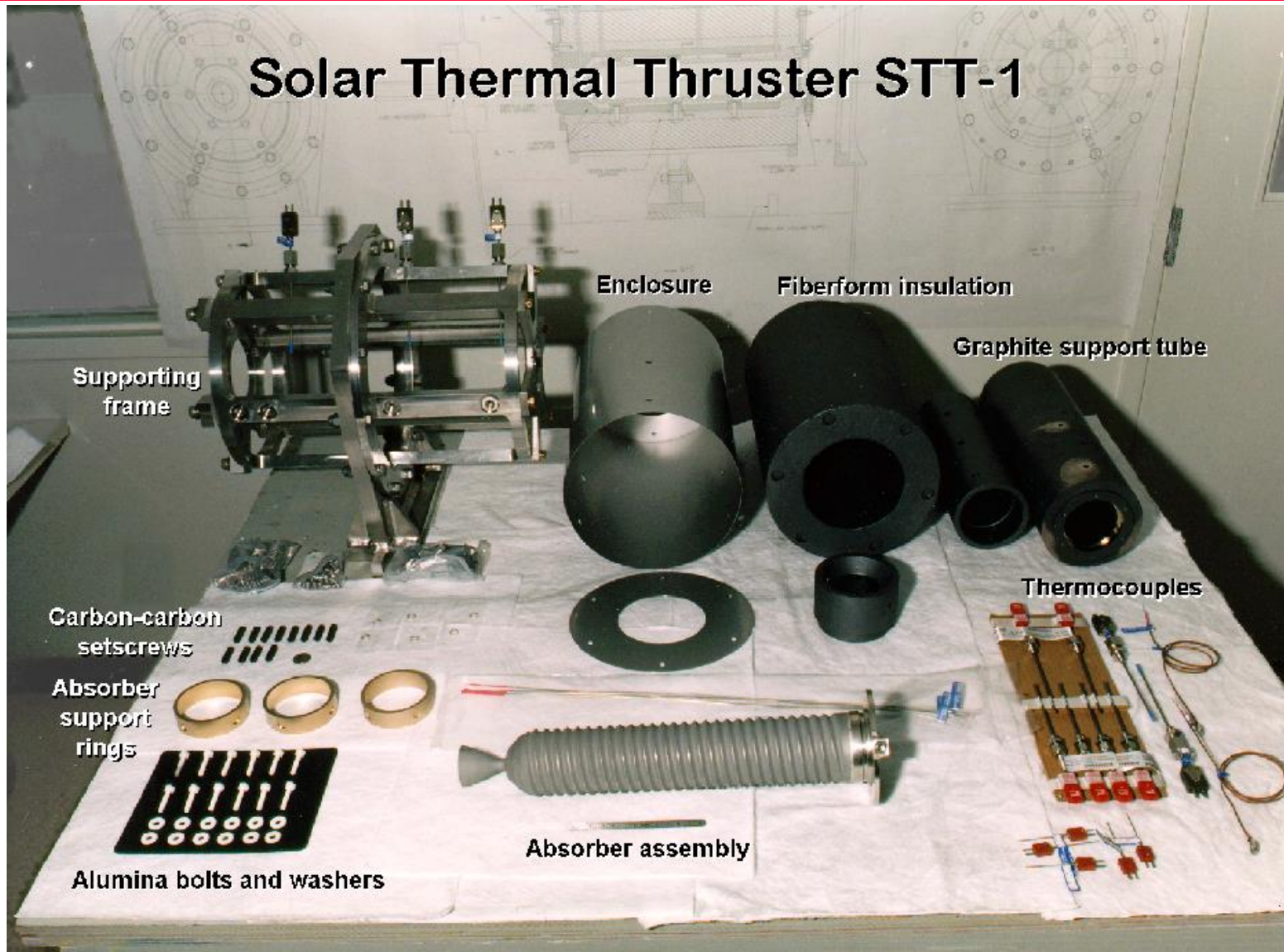

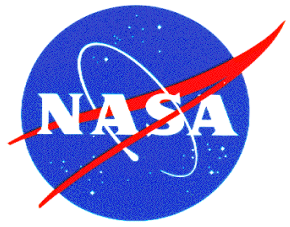

Direct Gain Thruster Types



Phase I Absorber/Thruster

- 100% Tungsten-Vacuum Plasma Sprayed
- Nickel Faceplate brazed



Phase II Absorber/Thruster

- 75% Tungsten/25% Rhenium Vacuum Plasma Sprayed
- 50% Rhenium/50% Molybdenum Faceplate
- Electron beam welded

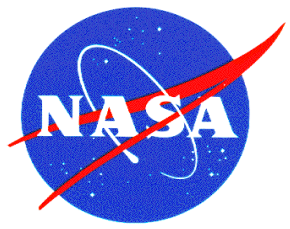

MSFC STP Facility

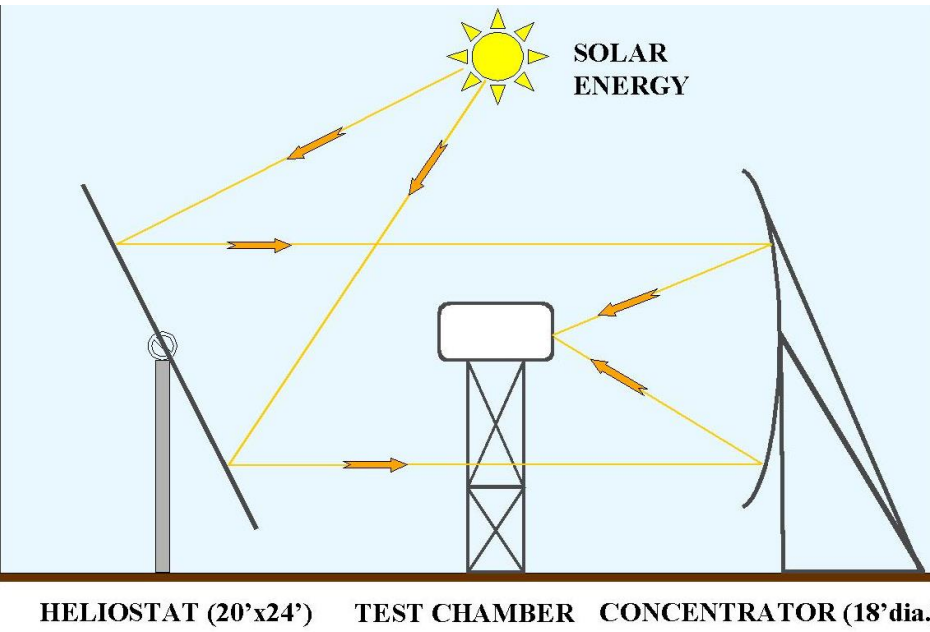

- 10 kW focused solar energy, 11cm dia.
- 91.5cm dia. X 123cm L vacuum test chamber
- Hot hydrogen open cycle test flow
- 4 hour operating window

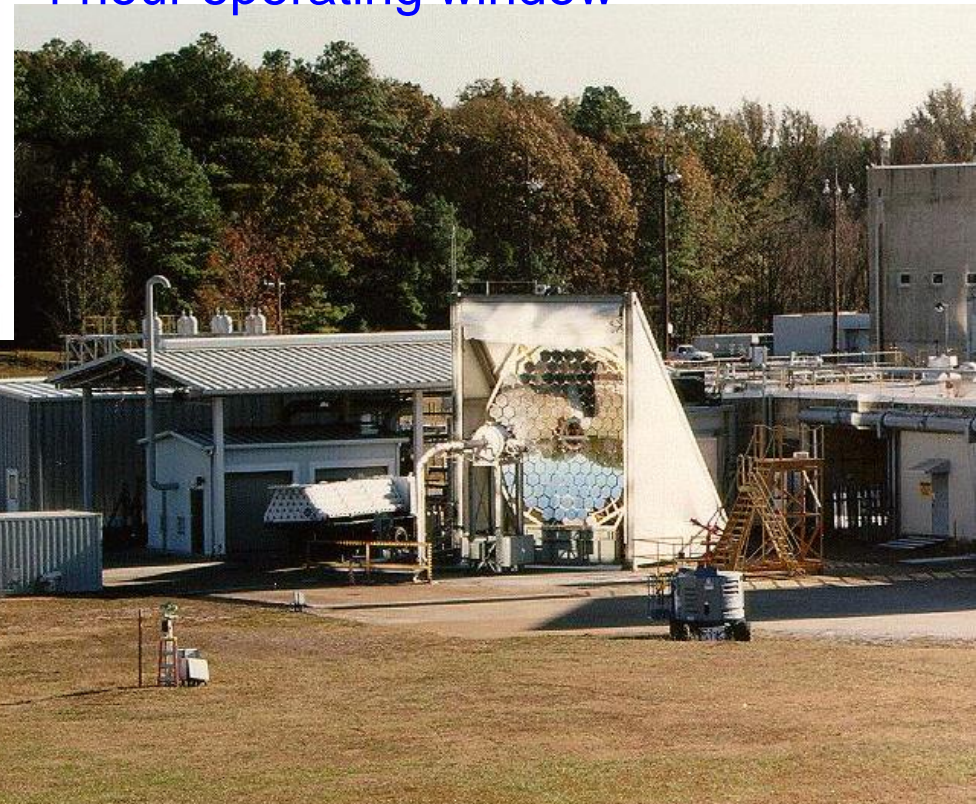

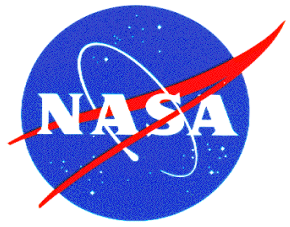

MSFC STP Facility



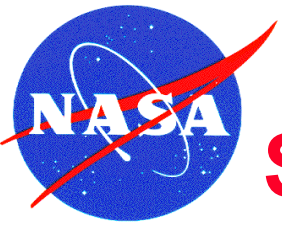

MSFC Solar Facility with Space Environment Simulator Option

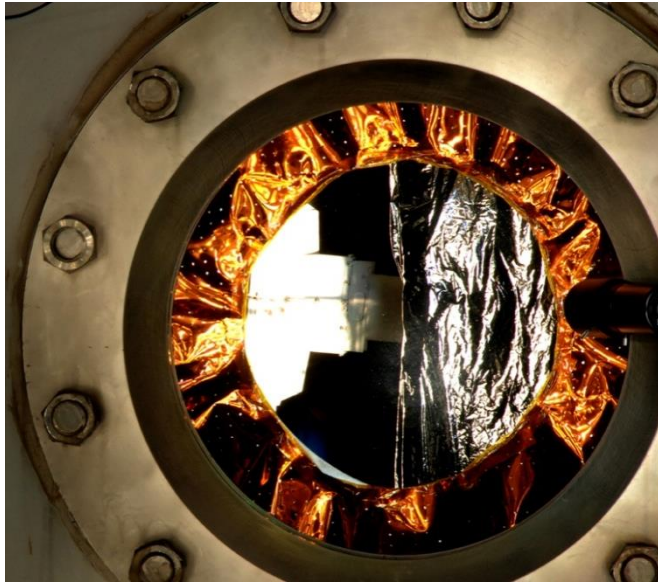

- Based on required solar intensity and shape of target, mirror covers adjustable
- Current full power on a blue sky day $\sim 1\text{MW}/\text{m}^2$
- Closed cycle tests with turbomolecular pump $\sim 10^{-6}$ Torr
- Black liquid nitrogen shrouds simulate deep space background

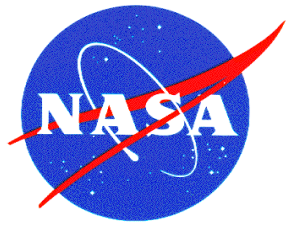

Engine Position Inside Test Chamber

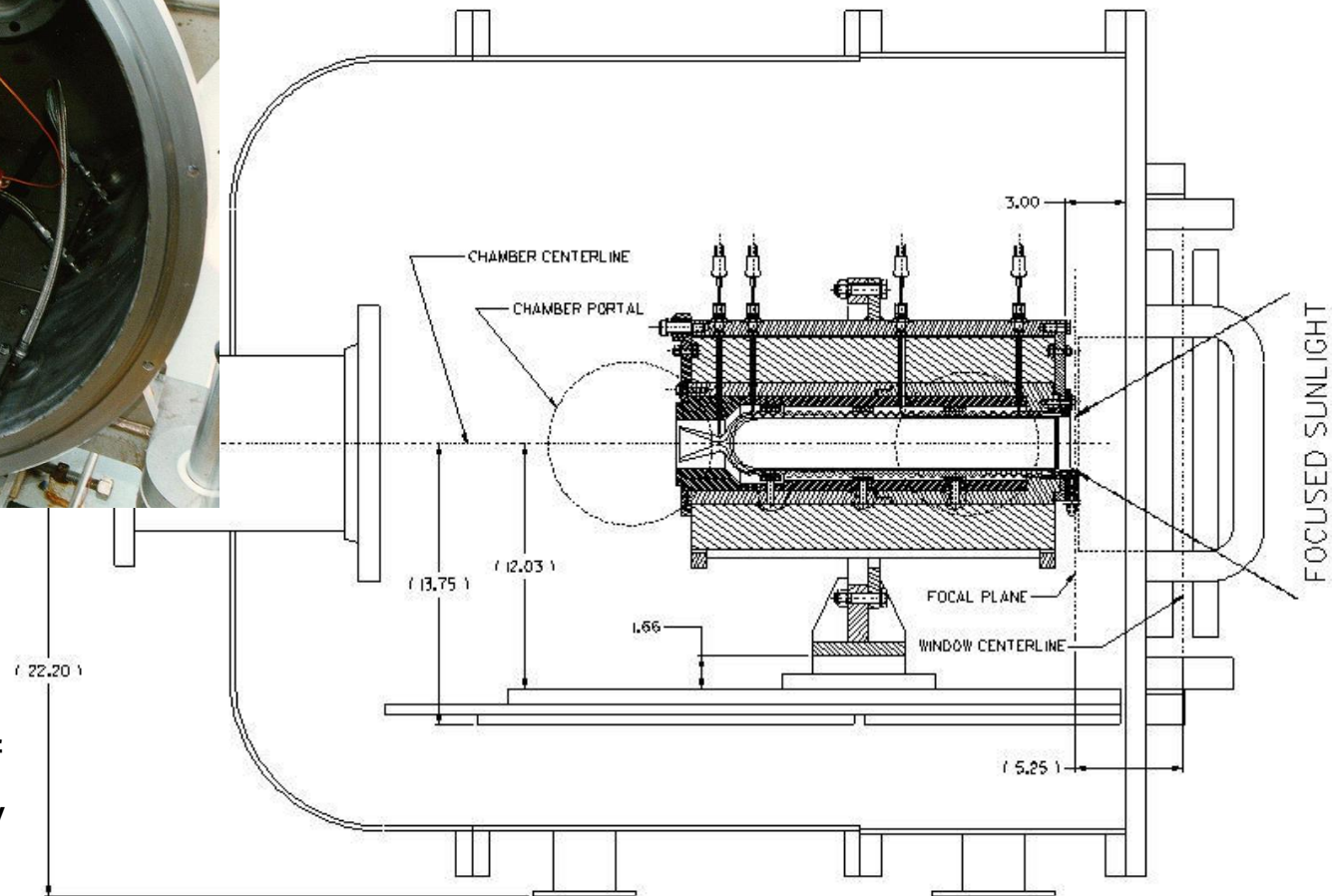
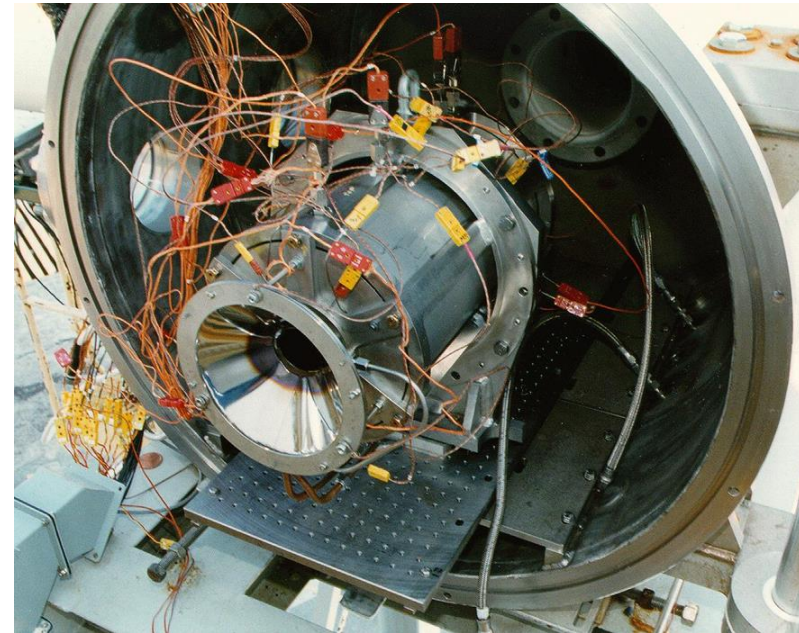

- Vacuum system lowers ambient pressure to $\sim .01$ psi for an open cycle .5 lbf thrust engine at steady state

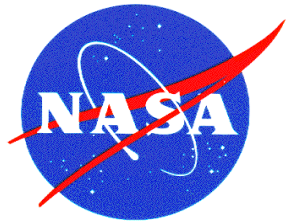

STP Test Results

Phase I Temperature Distribution

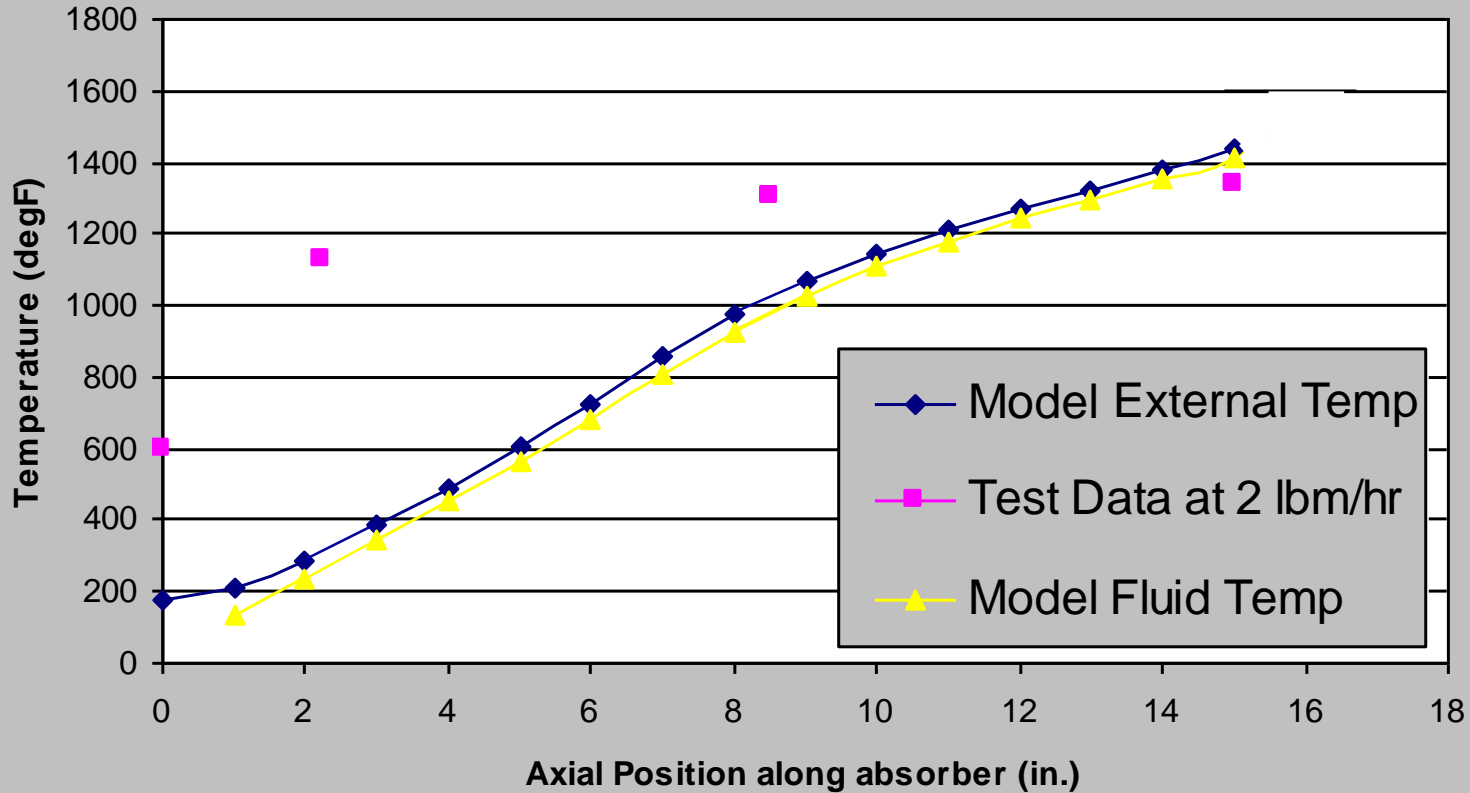

Only 4kW
solar input
to absorber
cavity

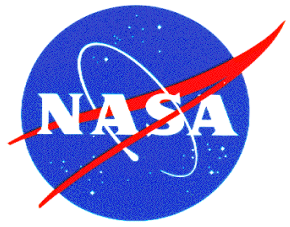

Secondary Concentrator

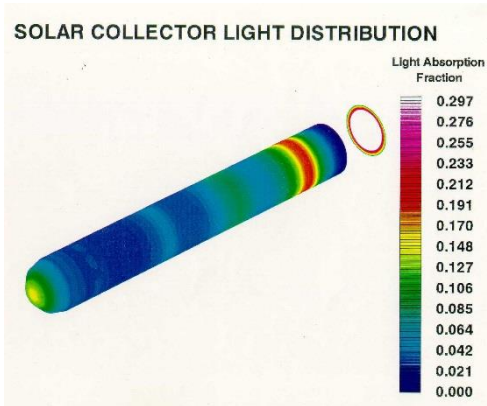

Light distribution with no secondary

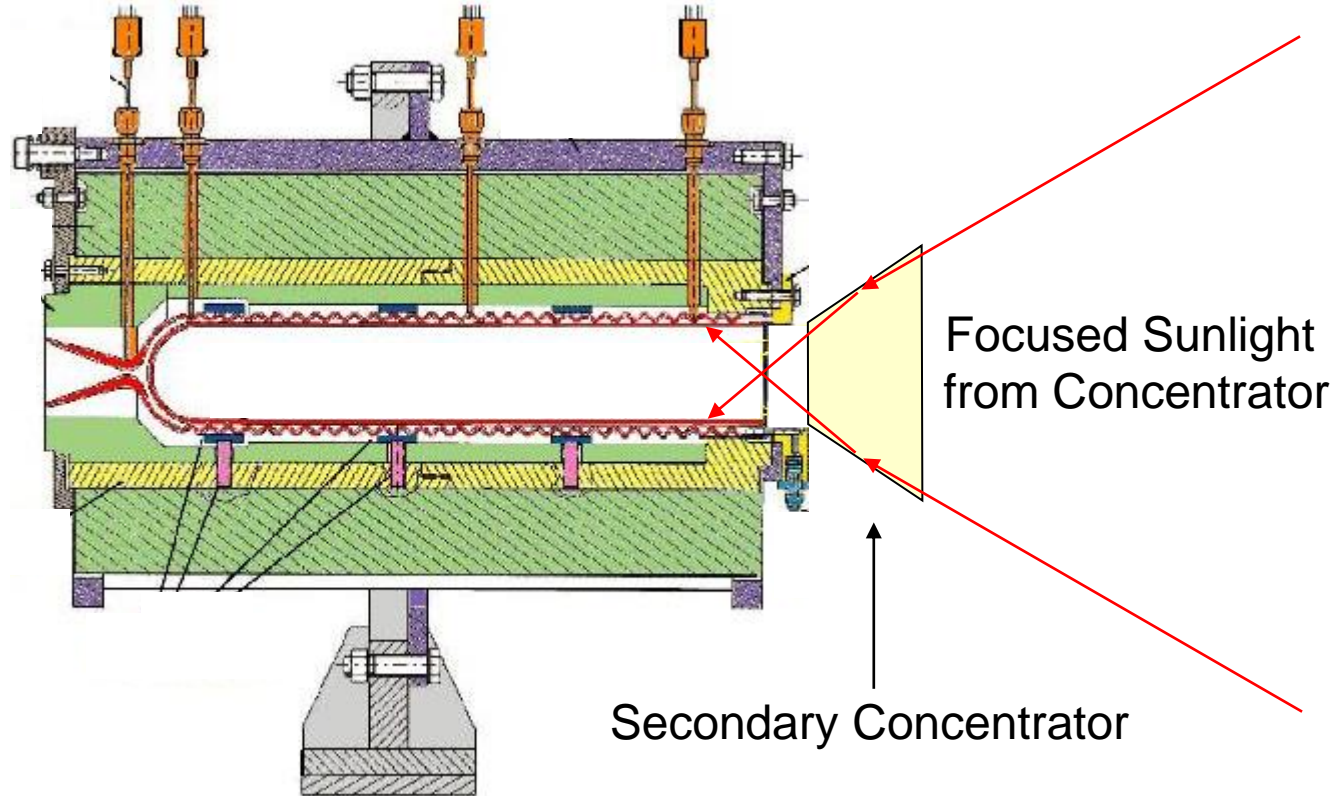

- Secondary can be reflective or refractive
- Larger capture area for absorber cavity
- Helps better distribute light inside the absorber cavity

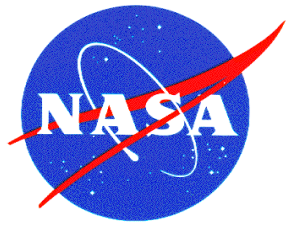

Refractory Secondary Concentrators



Prototype refractive secondary concentrator made of single-crystal sapphire

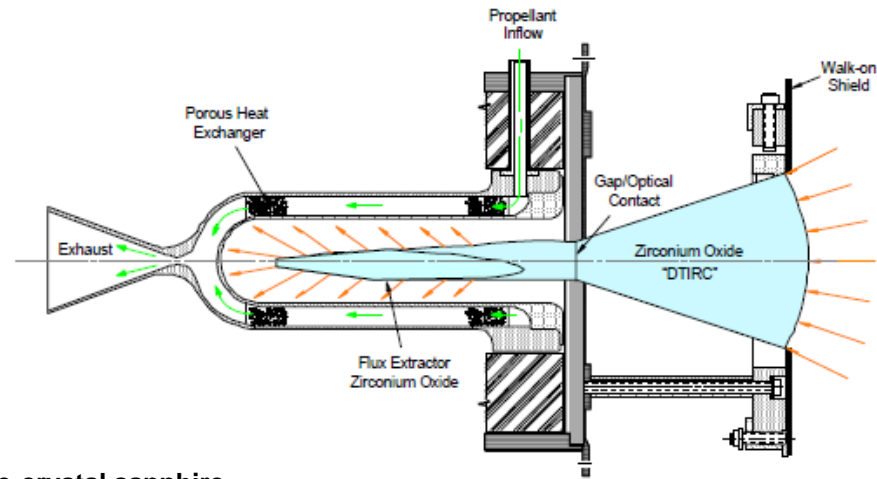

- A refractive secondary solar concentrator is a non-imaging optical device that accepts focused solar energy from a primary concentrator and redirects that light, by means of refraction and total internal reflection (TIR) into a cavity where the solar energy is used for power and/or propulsion applications
- The primary advantages are higher efficiency, higher concentration ratio, flux tailoring, and the ability to function without requiring elaborate cooling features.
- Past work done at GRC and Analex Corp. NASA TM-2000-208401 and link below:

http://r.search.yahoo.com/_ylt=AwrTccHzeqVWFw8AJ4QnnIIQ;_ylu=X3oDMTByb2lvbXVubGNvbG8DZ3ExBHBvcwMxBHZ0aWQDBHNIYwNzcg/RV=2/RE=1453714292/RO=10/RU=http%3a%2f%2fwww.ntrs.nasa.gov%2farchive%2fnasa%2fcasi.ntsr.nasa.gov%2f20050203997_2005204520.pdf/RK=0/RS=GEYM8map6dR6Tu4Rzo9NbvktPKs-

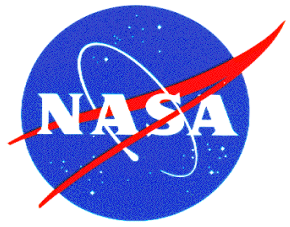

STP Ground Demonstration



+

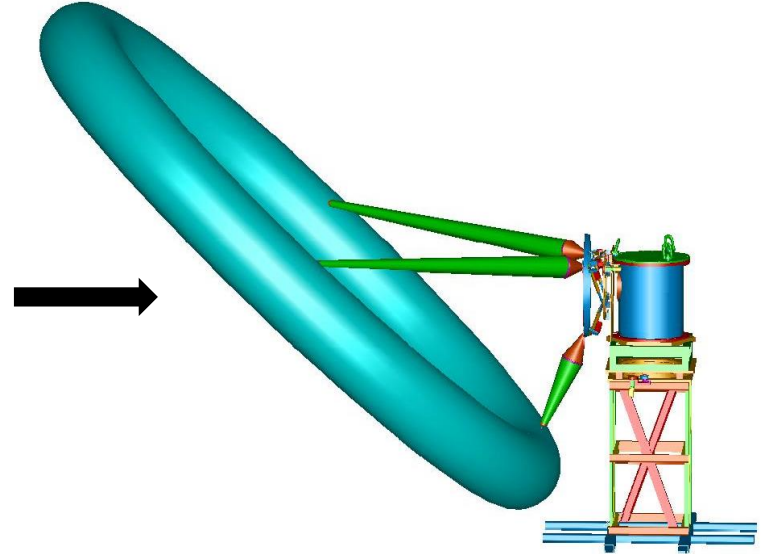

Past joint activity with MSFC, SRS, Thiokol and Air Force to have attempted a ground test rig that more closely simulates STP spacecraft operation:

- 4m x 6m inflatable concentrator attached to chamber with 6 DOF Hexapod
- High altitude test chamber rotates on a turn table like the spacecraft
- STP thruster inside test chamber
- Demonstrate start-up/shutdown transients and accounts for sun movement
- Eliminates heliostat mirror

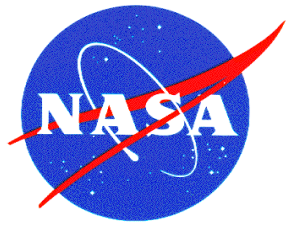

Inflatable Concentrator Deployment

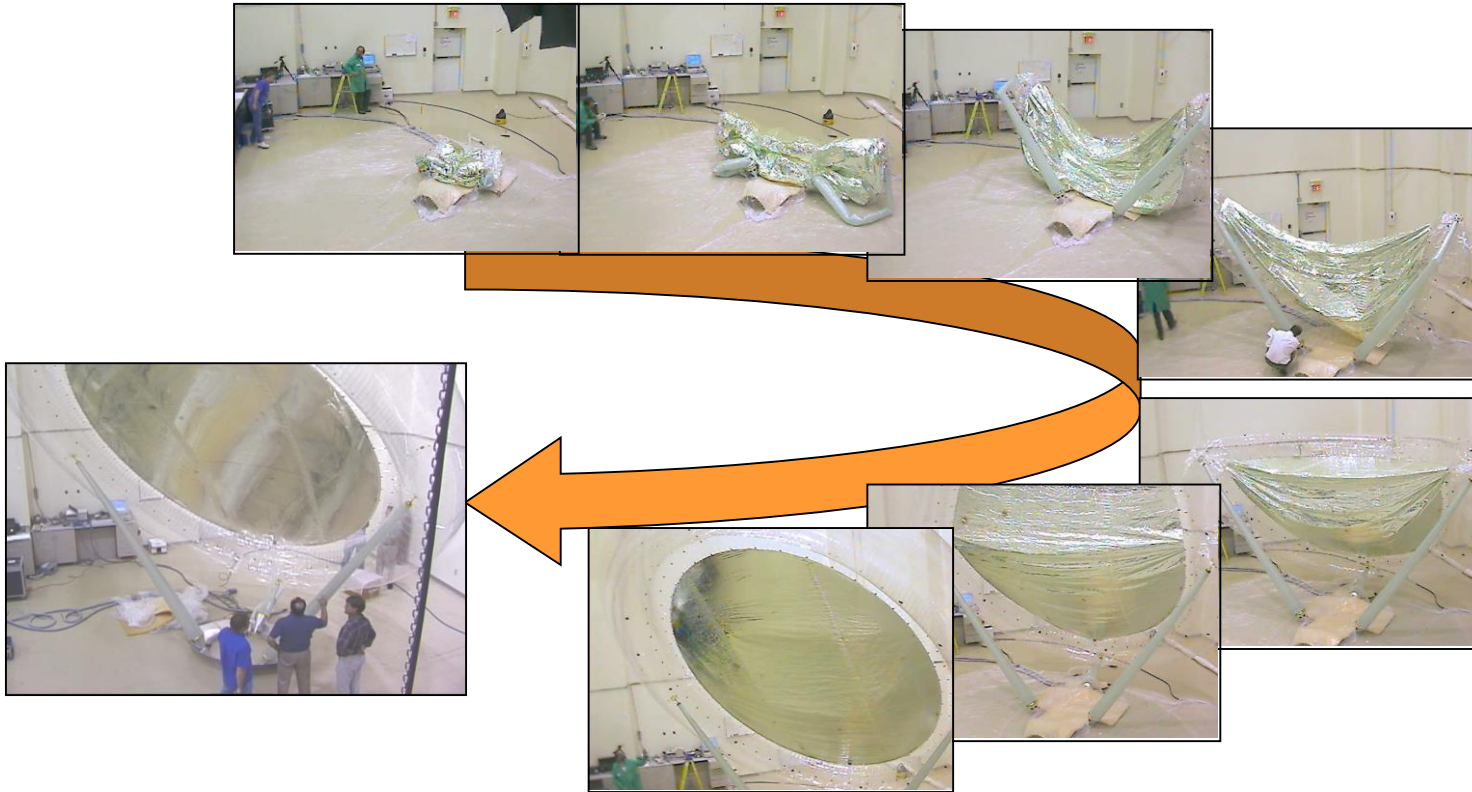

2000 Air Force Research Laboratory supported Thiokol and SRS integrated deployment test. Four deployment tests with maximum .5" variation in final position.

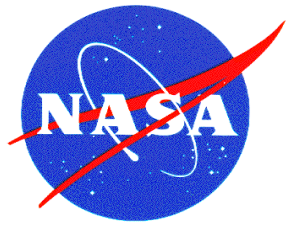

Why had STP lost Momentum?

“Results of Evaluation of Solar Thermal Propulsion”, AIAA-2003-5029

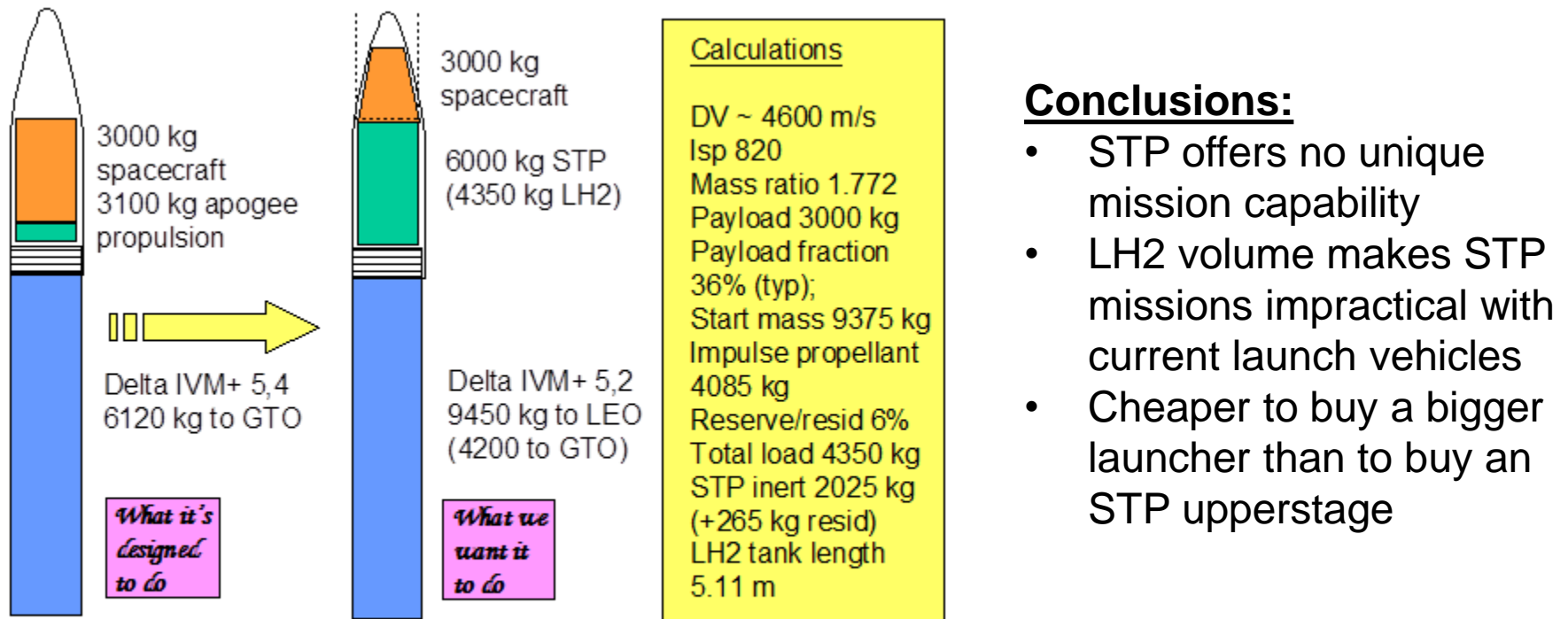

Current launch vehicles have too little fairing volume for STP GEO mission

Figure 6: Graphical Illustration of Payload Fairing Volume Problem

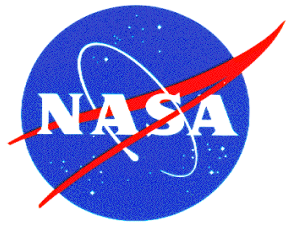

Recommendations

- 2015 NASA OCT Technology Roadmap TA02 for In-Space Propulsion describes STP in section TA 2.2.3.1 and a snapshot on page TA2-72.
- Reduce tank volume with increased STP specific impulse approaching 1200 seconds
 - Higher temperatures above 3000K increase Isp
 - At higher temperatures above 3000K and low pressures, hydrogen starts dissociating and lowers the average molecular weight, which also increases Isp
- Investigate using fuel depots and ISRU propellants.
- Since many new commercial companies are launching payloads, maybe re-examine current launch vehicle shroud volumes

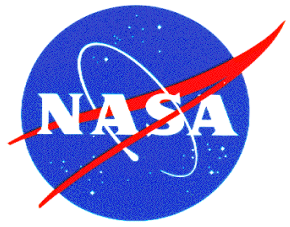

MSFC Solar Facility on Cable TV

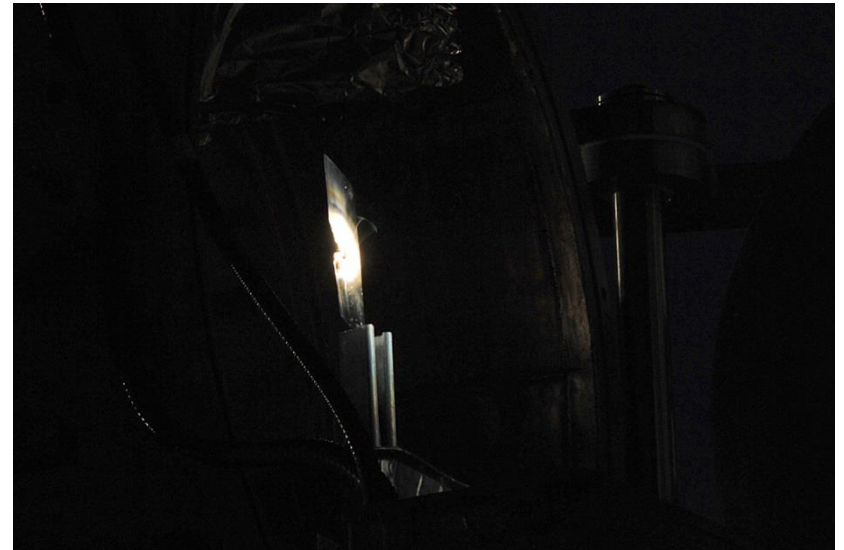

MSFC Solar Facility was on 2011 National Geographic Show “**Known Universe Season 3 Episode 03 Most Powerful Stars**”, 2:54 minutes to 6:15 minutes, to show what happens when you get too close to the Sun.

https://www.youtube.com/watch?v=W4Sp5iBx_6E