



# Beam Steering Mechanism (BSM) Lessons Learned

Kenneth A. Blumenstock, Alexander K. Cramer, Alan B. Gostin, Claef F. Hakun, Paul G. Haney, Matthew R. Hinkle, Kenneth Y. Lee, Carlos F. Lugo, Adam J. Matuszeski, Armando Morell, Nerses V. Armani, Joseph Bonafede, Molly I. Jackson, Peter J. Steigner, & Juan J. Strömsdörfer

NASA Goddard Space Flight Center, Greenbelt, MD  
Stinger Ghaffarian Technologies Inc., Greenbelt, MD

*Proceedings of the 43rd Aerospace Mechanisms Symposium  
NASA Ames Research Center  
May 4-6, 2016*





# Agenda

- ICESat-2 ATLAS Overview
- BSM Overview
- Three Lessons Learned
- Conclusion





# ICESat-2 ATLAS



Image illustrating AMSR-E sea ice courtesy of the NASA Scientific Visualization Studio.

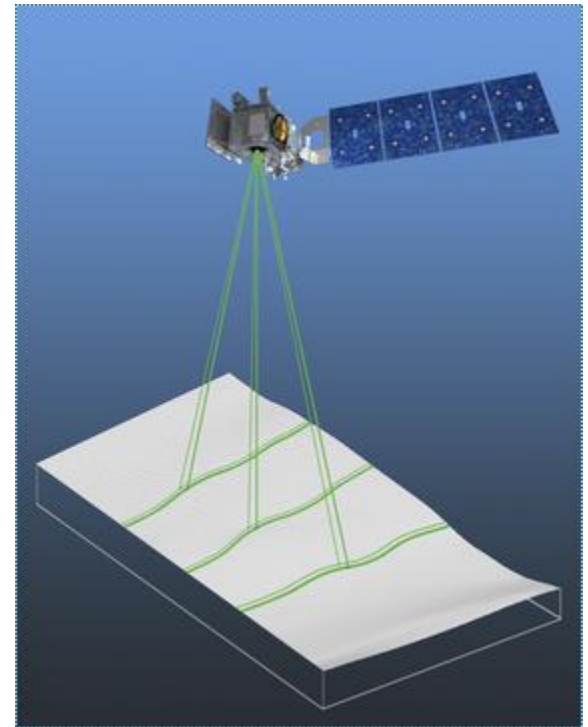

*Primary Mission Goals - Collect altimetry data of the Earth's surface optimized to measure ice sheet elevation change and sea ice thickness, while also generating an estimate of global vegetation biomass.*





# AMCS - Alignment Objective

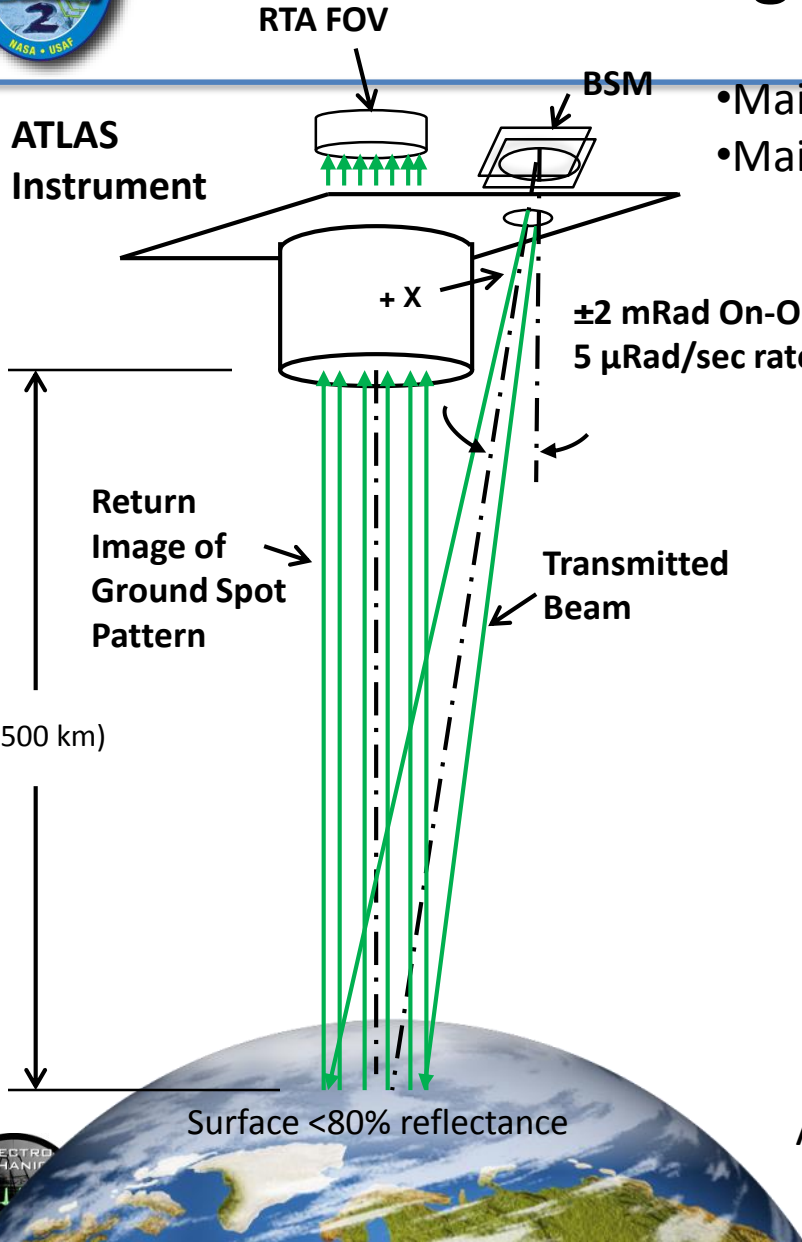

- Maintain return "spots" on and within RTA FOV
- Maintain alignment over mission as defined in TAR10

6 Receiver FOV 83.6°  
Fibers  
6 Ground Return Spots  
Nom. 20 μR Ø, r (1/e<sup>2</sup>)

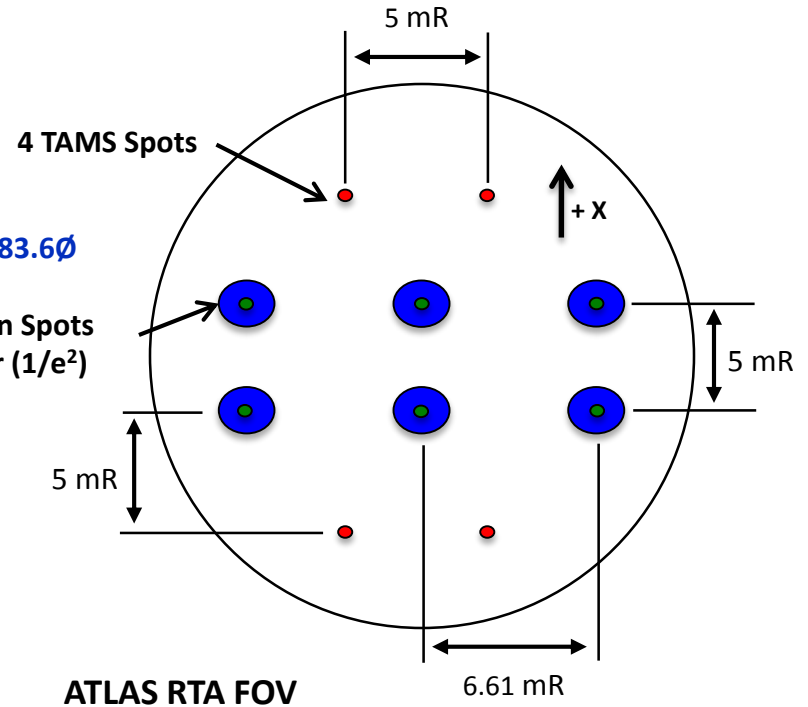

AMCS - Alignment Monitoring & Control System





# Transmit/Receive Alignment

- Necessary to maintain alignment between the transmitter and receiver
- MOLA, GLAS IR channel, MLA, and LOLA depended on structural stability
- GLAS green channel had ground-commandable steering mirror in receiver
- ATLAS has the smallest transmitted beam, smallest receiver FOV, and smallest alignment margin of GSFC space-borne laser altimeters
- With such small margin, only an active alignment system can guarantee the required signal capture

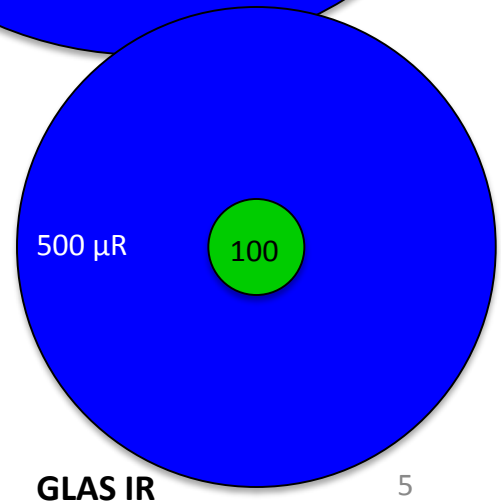
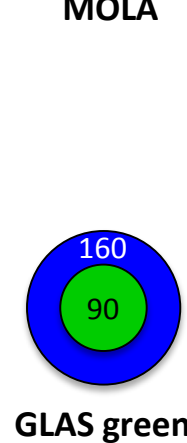
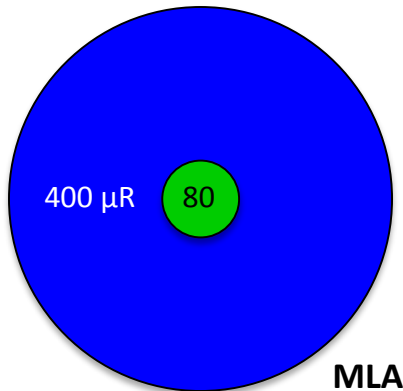
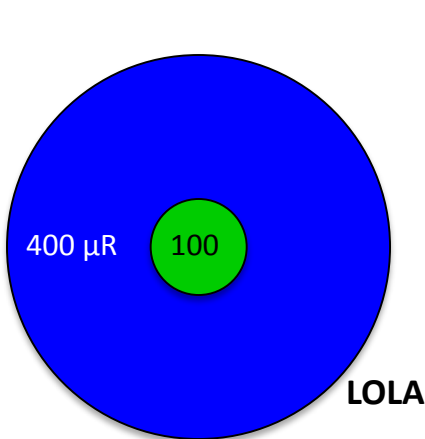
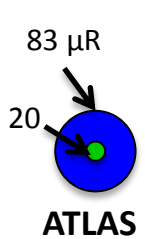
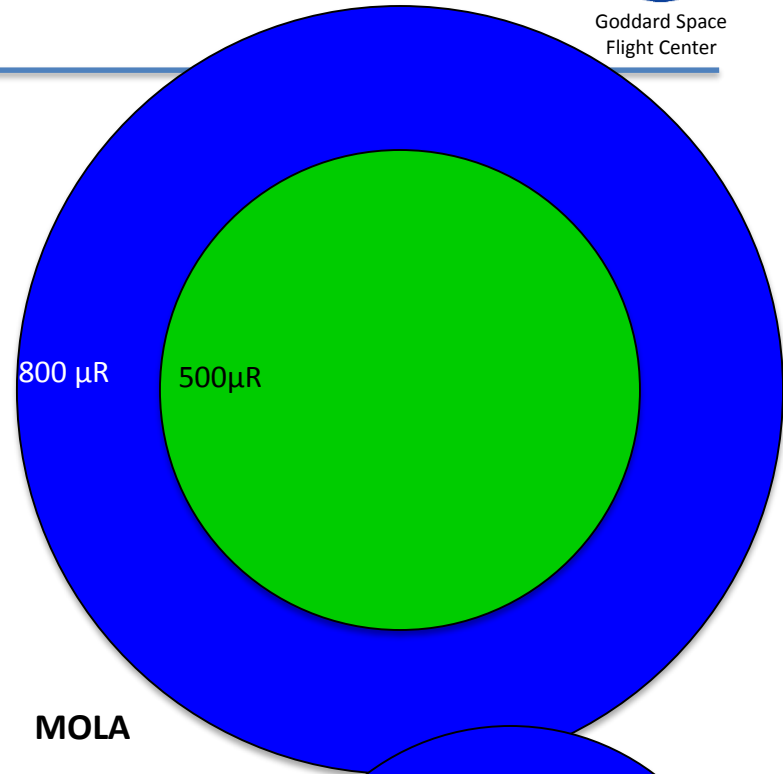



# ATLAS Instrument

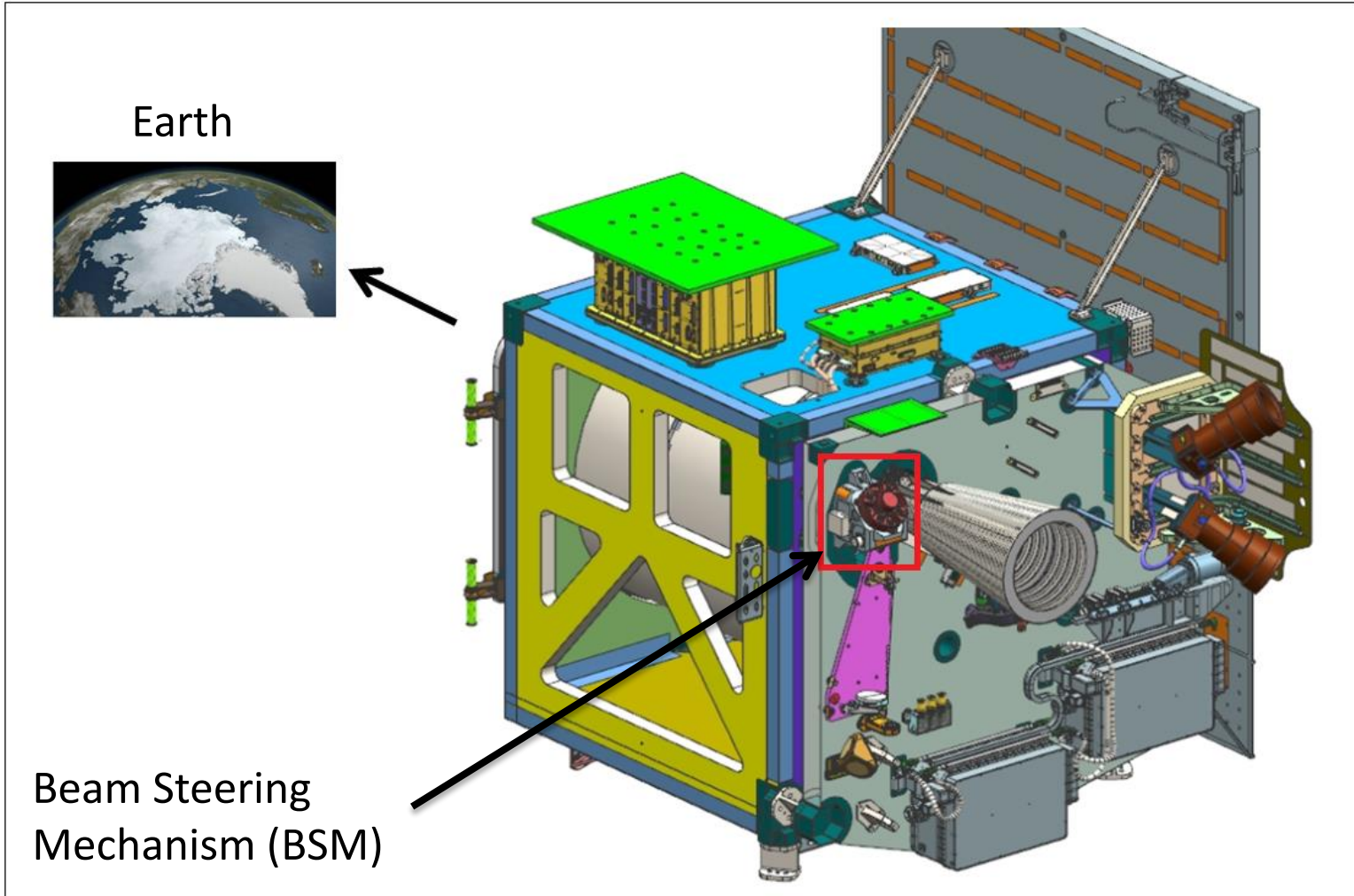



# BSM Views 1

BSM Assembly components:

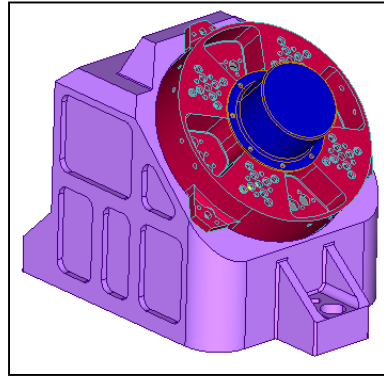

Mount

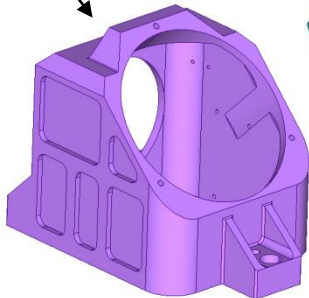

Mirror Mount

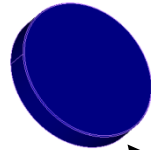

Mirror



Wave Washer

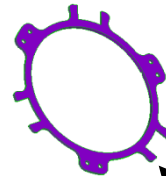

Compression Plate

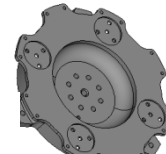

Moving Plate

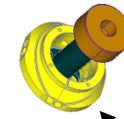

Flexure & Counterweight

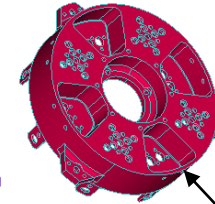

Fixed Plate

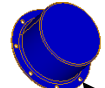

Cap



Flexure





# BSM Views 2

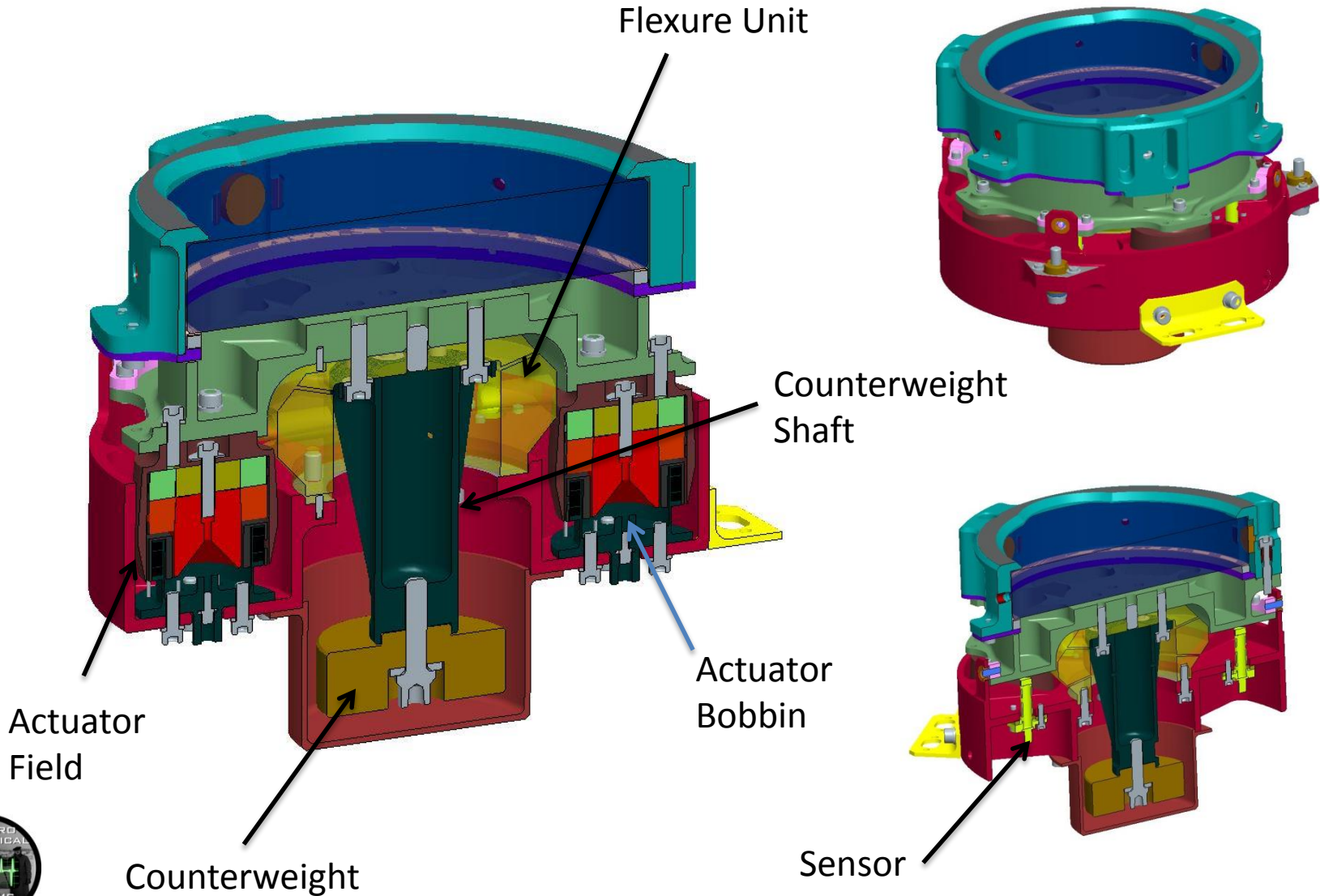





# Voice Coil Actuators

High performance flight actuators designed and built in-house

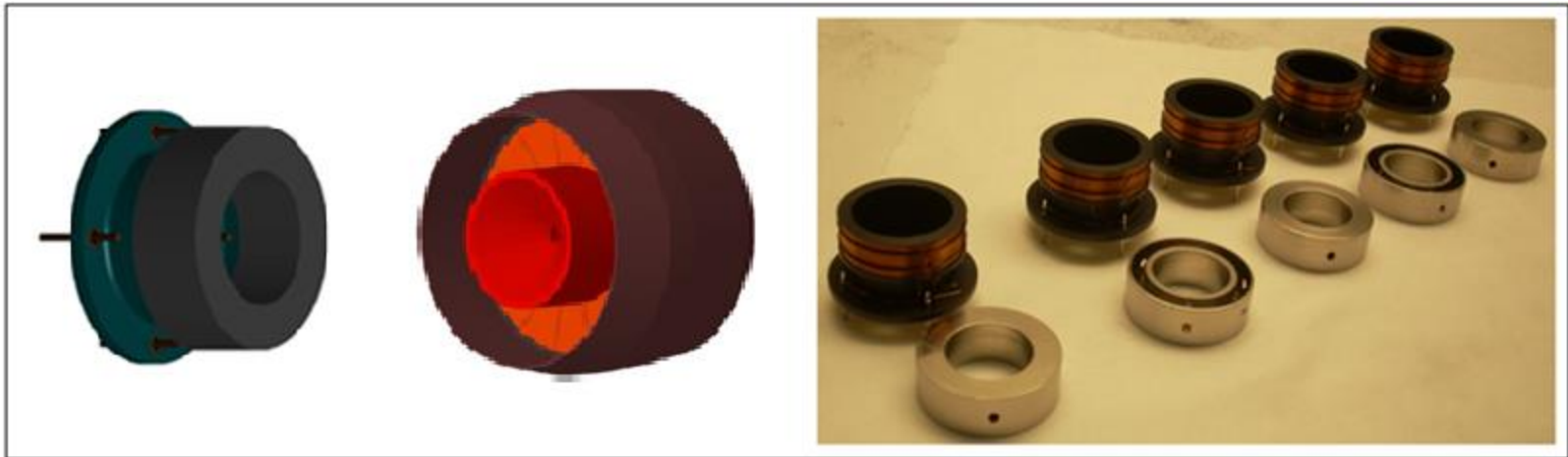
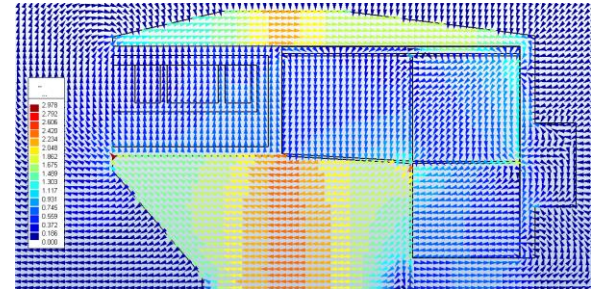
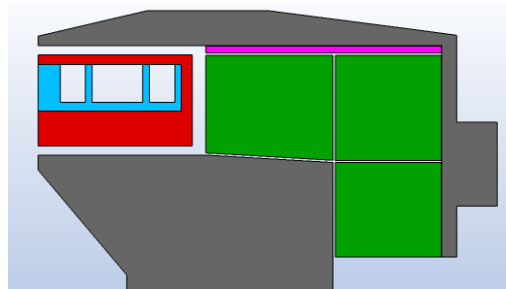
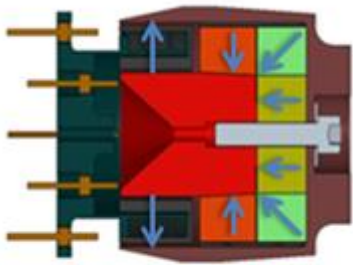



# Mechanism Control Electronics MCE

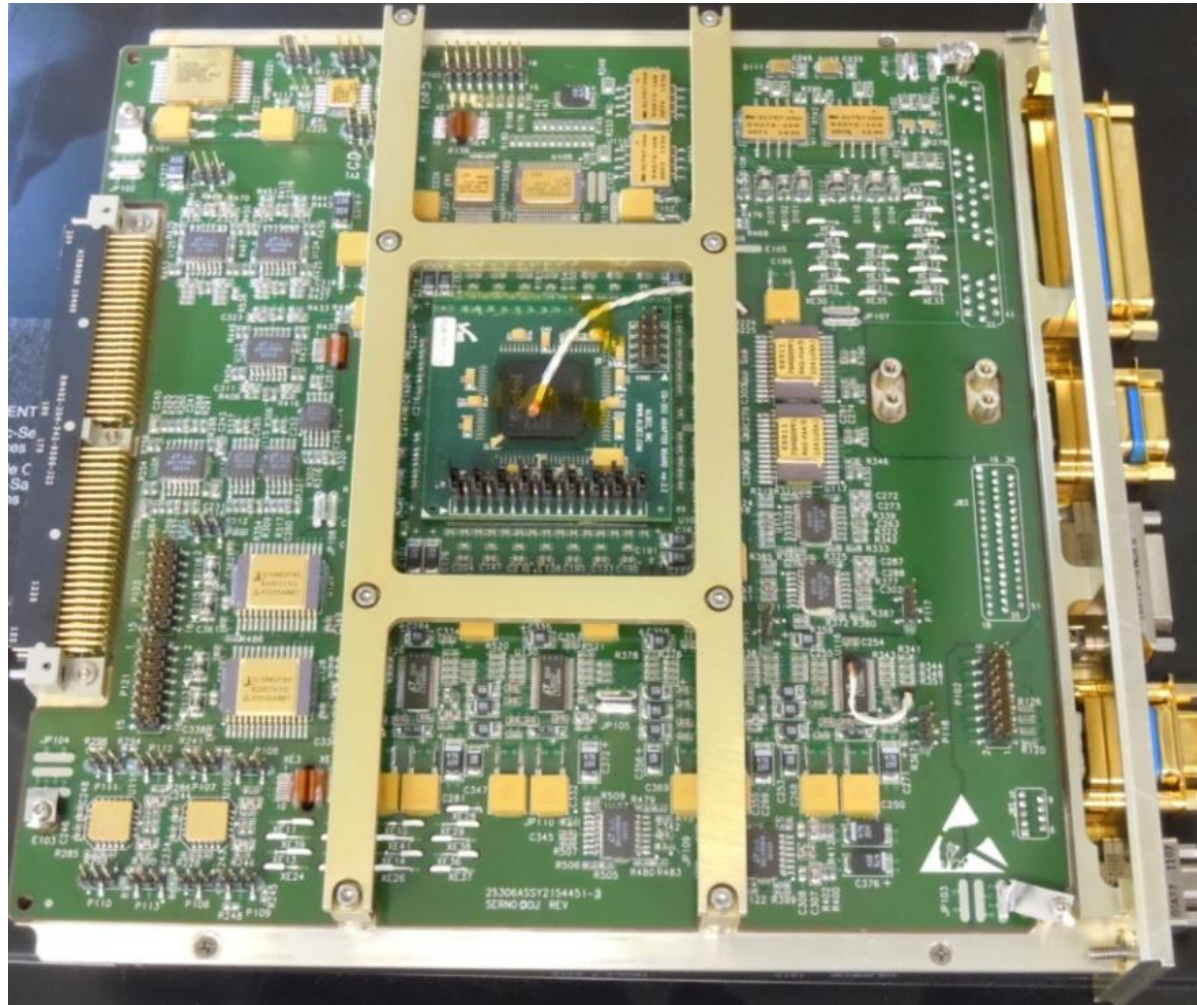



# BSM Driving Requirements

- Range of motion
  - Flexure configuration
- Position stability
  - High bandwidth
  - Structural modes
- Position knowledge
  - Accuracy
  - Sensor selection
- Very high mirror reflectivity at laser wavelength
  - Mitigates heating and distortion of mirror
  - Size, weight, coating, figure
- Environmental
  - Vibe: Avoid need for a launch lock if possible
  - Thermal Stability





# BSM Noteworthy Design Points

- Mirror
  - Dielectric coating resulted in heavy glass mirror
  - Allowed high reflectivity and tight figure
- Flexure
  - Significant engineering effort
  - Optimized to trade structural modes
- Actuators
  - Custom design for high performance
  - High damping for pointing performance
  - No launch lock needed due to high damping
- Sensors
  - Blue Line DIT sensors selected; aluminum targets
  - Optimization of performance parameters
- Thermal Stability
  - Material selection





# Lesson 1 – Pointing Verification

- Very challenging major focus.
- No single metrology solution.
  - Zygo 2-axis interferometer
  - Leviton Inter-target Differential Electronic Autocollimator (IDEA)
  - Leica T3000 Theodolite
- Needed high resolution, high accuracy, and absolute position verification over the BSM mirror's full range of motion.





# Pointing Verification Troubles

- The Zygo wavelength was not compatible with the dielectric coating rendering one axis useless due to severe non-linearity and requiring characterization of the non-linearity of the axis used so that it could be removed by means of post processing.
- Synchronization of internal sensor data and Zygo sensor data was troublesome.
- The Zygo angular range was much less than the BSM range of motion.





# Pointing Verification Setups

Zygo Interferometer Setup on Optical Bench

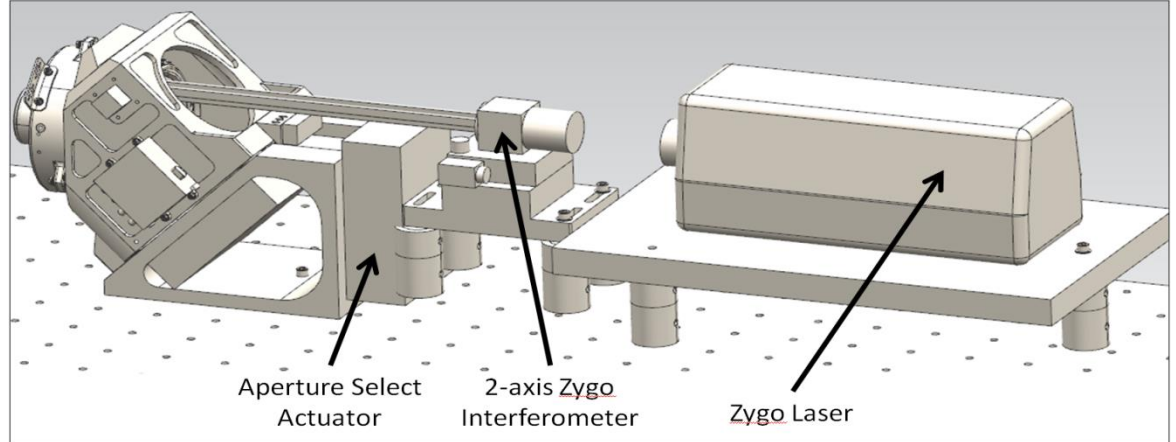

IDEA Setup Outside TVac Chamber

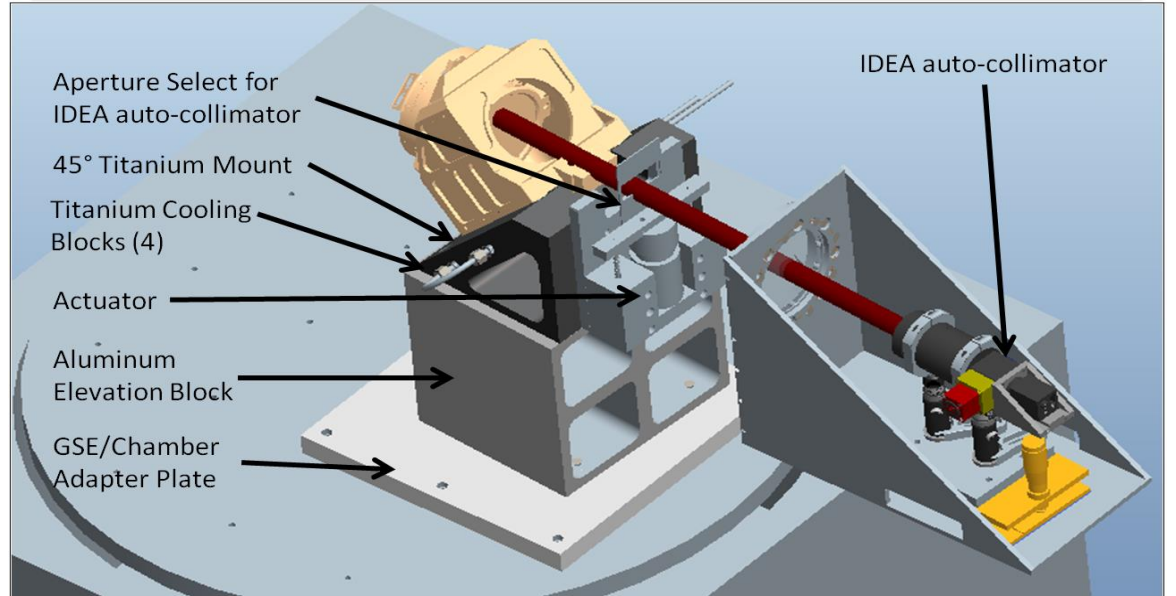



# BSM Optic and Optical References

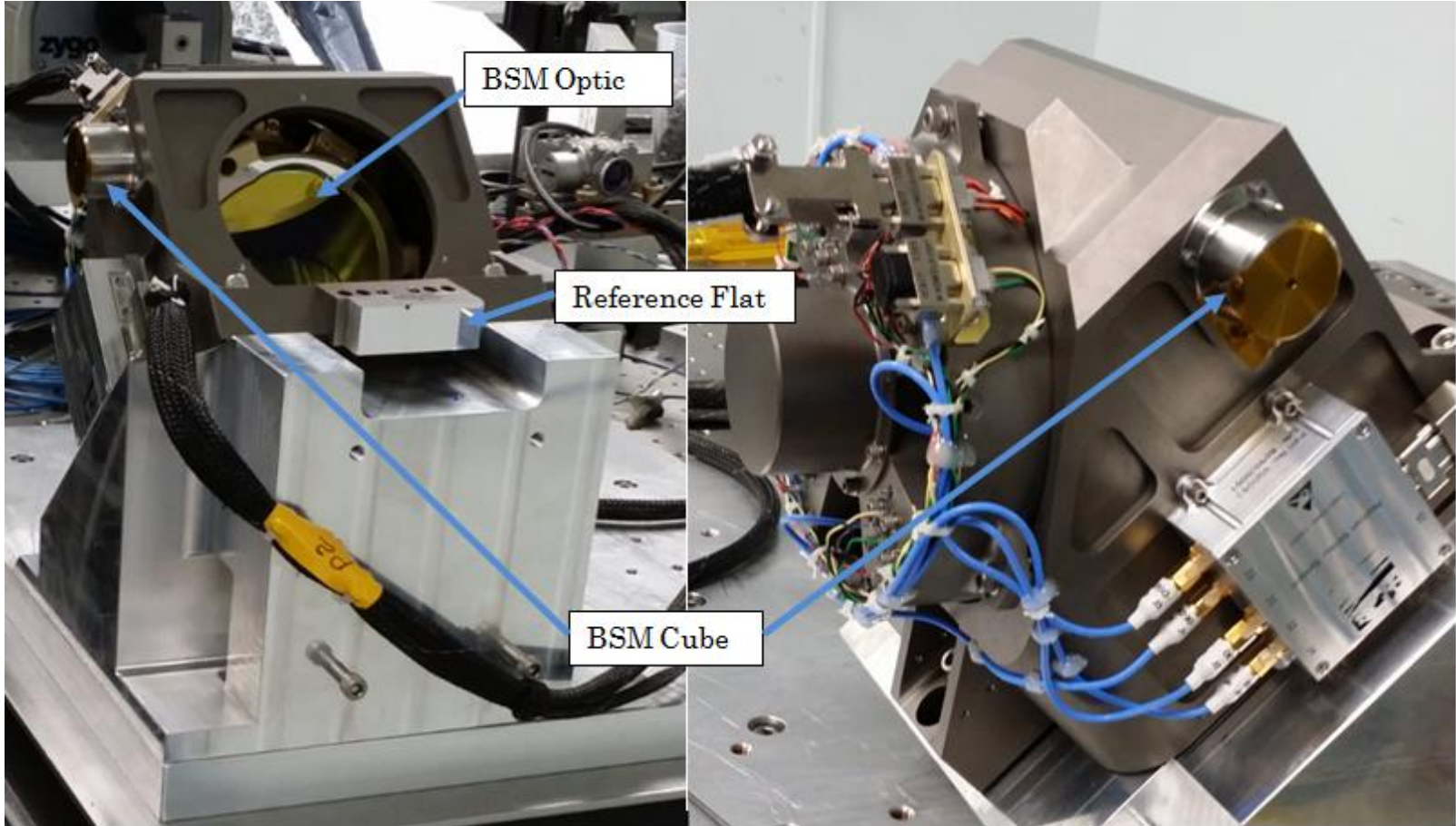





# Pointing Verification Strategy

- Optical measurements during TVac were taken using IDEA, whose wider FOV could tolerate gross motion of the BSM mount due to temperature changes in the vacuum chamber.
- IDEA measurements were used to make temperature-dependent adjustments to the scale factor, determined before TVac.
- Performance over the full range was quantified using interferometer data which had been post-processed to remove non-linearities.
- Processing a combination of data from these three instruments verified BSM pointing performance over its full required range of motion and temperature.





## Lesson 2 – Troubling Structural Mode

- Measurement of the frequency response revealed a very undesirable structural mode near 900 Hz.
- Using FEM modal analysis, we were unable to determine the source of this very troubling behavior.
- Performance was met with filtering, but consuming controller filtering capability for possible future structural mode changes.
- A brute force approach was utilized by replacing components.
- It was theorized that the counterweight shaft was lacking stiffness, so a ribbed shaft was designed and fabricated.
- The stiffer shaft solved the problem.





# Before/After Balance Shaft Replacement

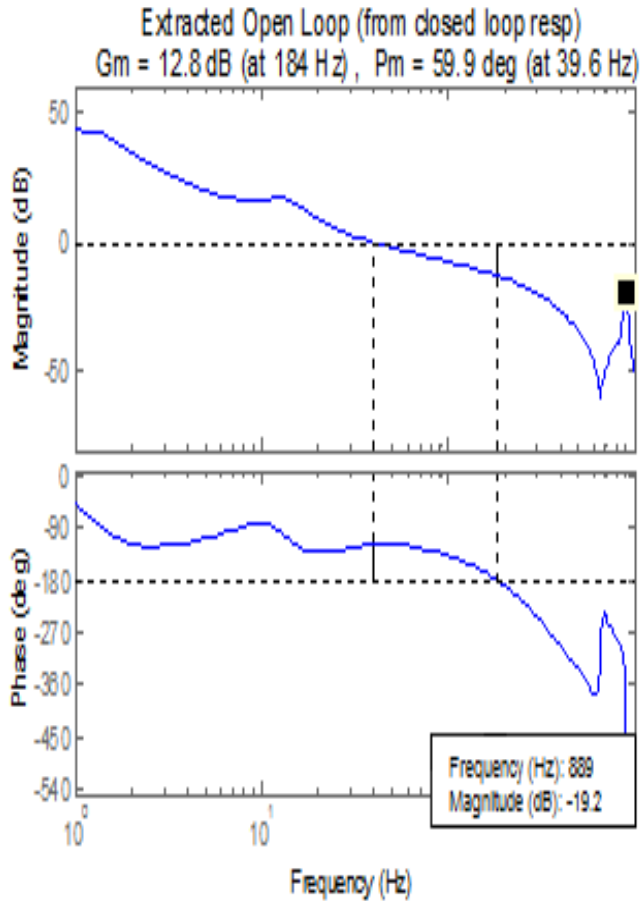

Before

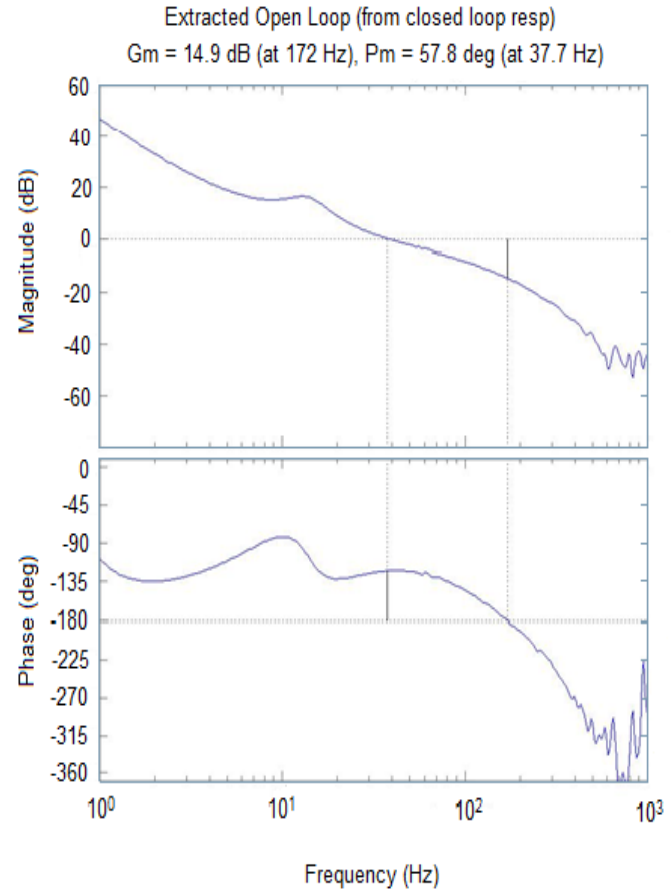

After





# Lesson 3 – Puzzling Flight Model Behavior

- Discovered in the Flight Model upon completion of performance testing just before environmental testing.
- Mirror motions from Point A to Point B resulted in passing the target and circling back at greater magnitudes than previously observed.
- Controls engineers believed there to be a balance problem
- Balancing was achieved by using a balance fixture to change the gravity vector by 180 degrees; then the counterweight was adjusted such that minimal motion occurs upon 180 degree gravity vector changes .





# BSM FM in the 6-Axis Balancing Fixture

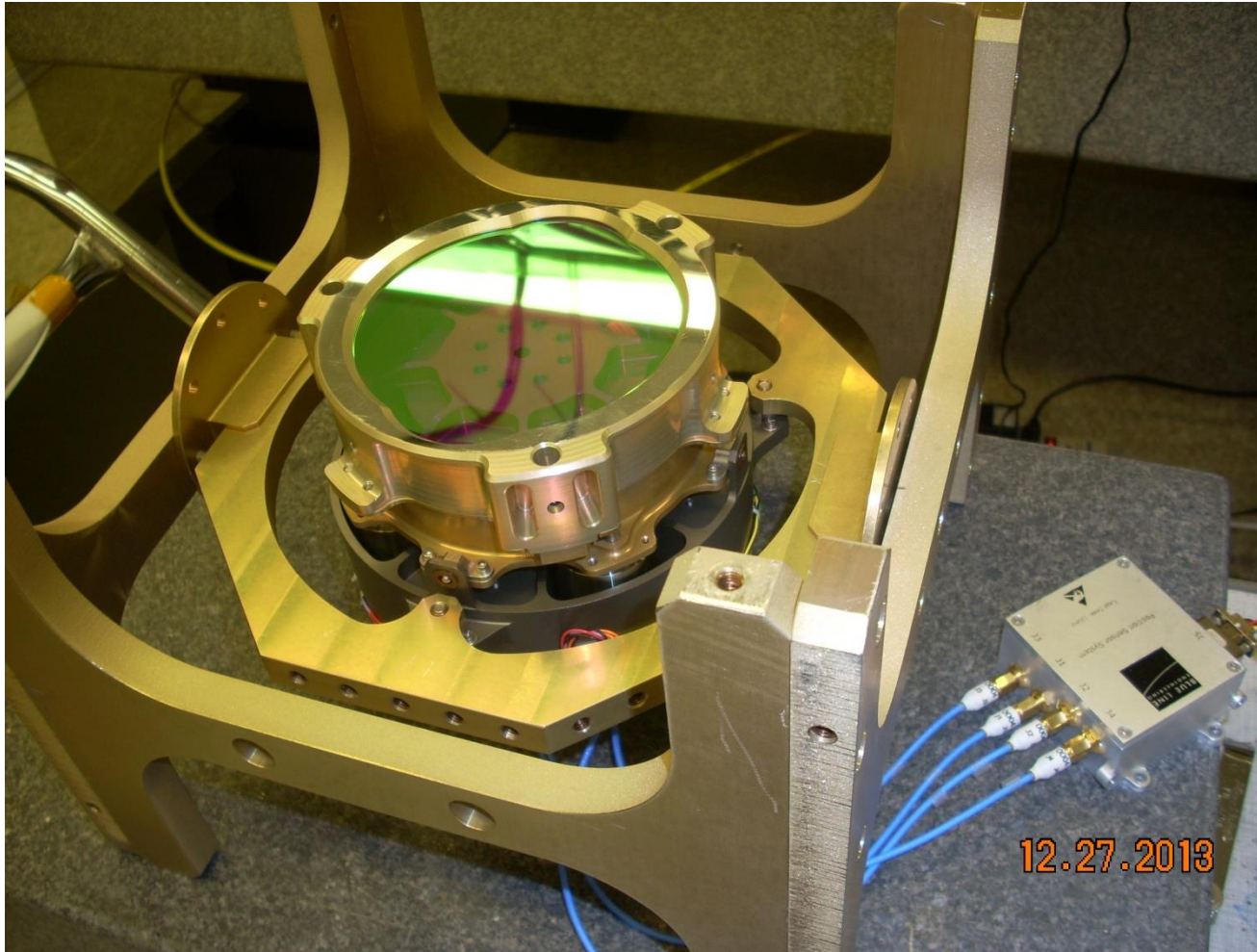



# Investigation

- Investigation revealed when balancing in the vertical (gravity) direction that our technician observed there was significant motion in the horizontal (non-gravity) direction.
- Our technician was instructed to ignore the horizontal axis motions when performing balancing.
- It was found that the horizontal motions were very significant in the Flight Model and were minimal in the Engineering Model.





# What Happened?

- It so happened that the flexure axes were rotated 45 degrees from the sensor axes.
- If the two flexure axes do not have their rotation axes located in the same place, the counterweight can balance one or the other flexure axis, or find a compromise.
- In this case, one flexure axis was balanced mirror light and the other flexure axis equally balanced mirror heavy, resulting in horizontal motion.
- The problem was in the manufacturing tolerance of the flexure being out of spec, resulting in a 9 mil (0.009 inch) separation of rotation axes.





# Imbalance Phenomena Graphic

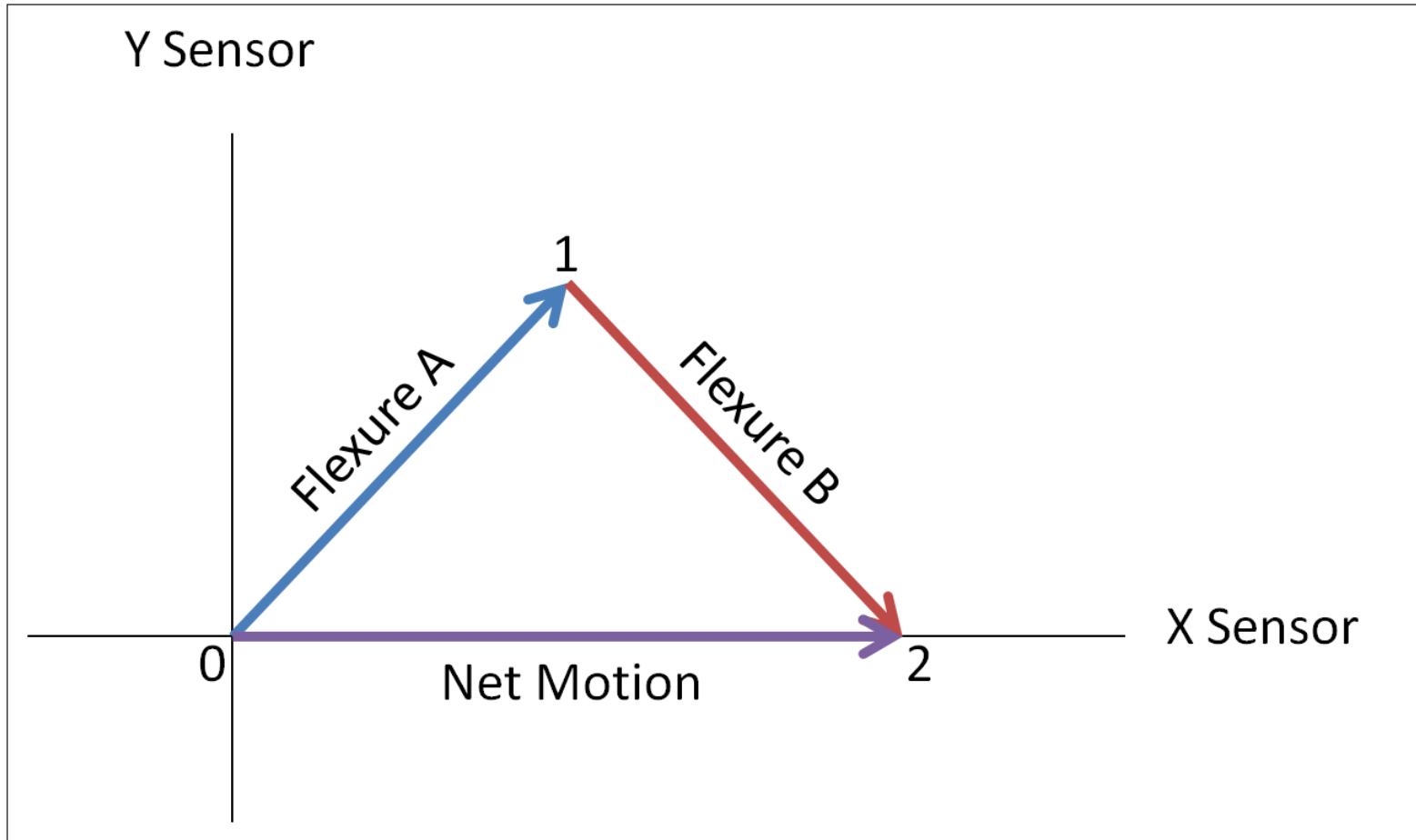





# In Hindsight

- Had the flexure axes been aligned with the sensor axes, we would have realized balancing one axis results in the other being unbalanced.
- Had we paid more attention to our technician, we would have discovered the problem earlier.
- We suffered a painful schedule slip to await flexure remanufacture, integrate into the Flight Model hardware, and repeat performance testing.
- It turned out that we had previously used our best flexure for vibe/life testing, so we needed to remanufacture as good or better for the Flight Model, which was achieved.





# Conclusion

- The team was very motivated to be tasked with meeting requirements not faced before.
- We never before developed hardware to meet sub-arcsecond levels of pointing.
- Pointing requirements were met with margin.
- Verification of systematic error throughout mission life, full range of motion, and full range of temperature, was extremely challenging.
- As position knowledge and pointing requirements for similar systems in the future become more demanding, verifying these requirements will require not only the synthesis of measurements from multiple references, but also deep understanding of the limitations of each reference chosen.





# BSM Pointing Stability

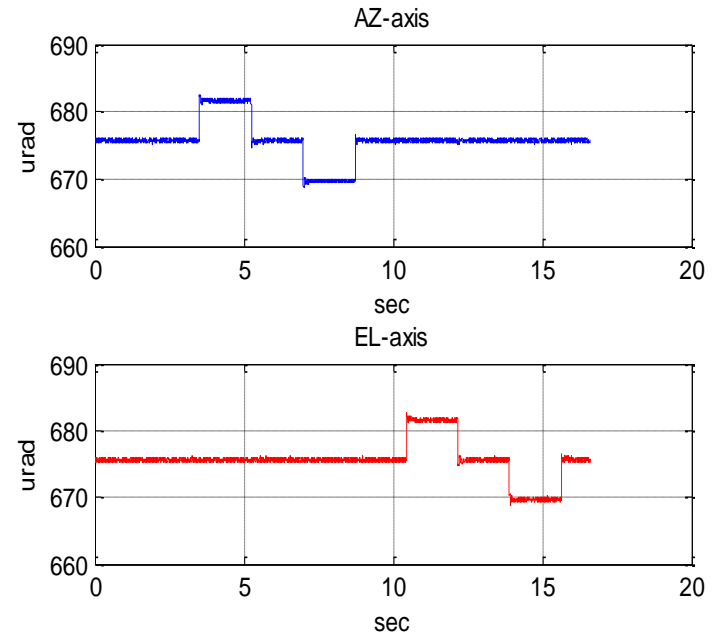
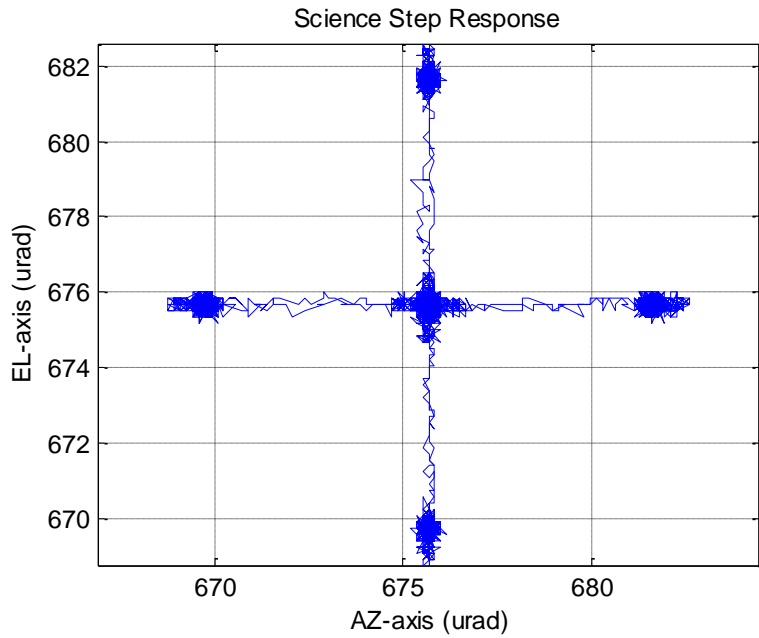



# BSM Pointing Stability

- We have achieved  $0.2 \mu\text{Rad}$  rms pointing stability, an order of magnitude better than our requirement
- If using the BSM, you reflected a laser from NASA Ames Research Center to San Francisco International Airport, which is 40 km away, the center of the spot would stay on a dime.

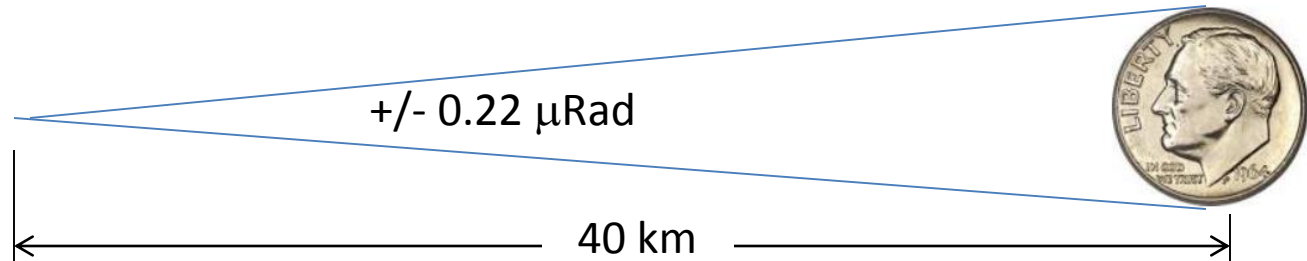



# BSM Integrated onto the ATLAS Bench

