



# *Engineering In Action*





# Paving the Path for Human Space Exploration: The Challenges and Opportunities

**Lauri Hansen**  
**Director, JSC Engineering**

Johnson Space Center  
May 2016

# The Future of Human Space Exploration

## NASA's Building Blocks to Mars

U.S. companies provide affordable access to low Earth orbit

Mastering the fundamentals aboard the International Space Station

Pushing the boundaries in cis-lunar space

The next step: traveling beyond low-Earth orbit with the Space Launch System rocket and Orion crew capsule

Developing planetary independence by exploring Mars, its moons, and other deep space destinations

*Missions: 6 to 12 months*  
*Return: hours*

*Missions: 1 month up to 12 months*  
*Return: days*

*Missions: 2 to 3 years*  
*Return: months*

Earth Reliant

Proving Ground

Earth Independent

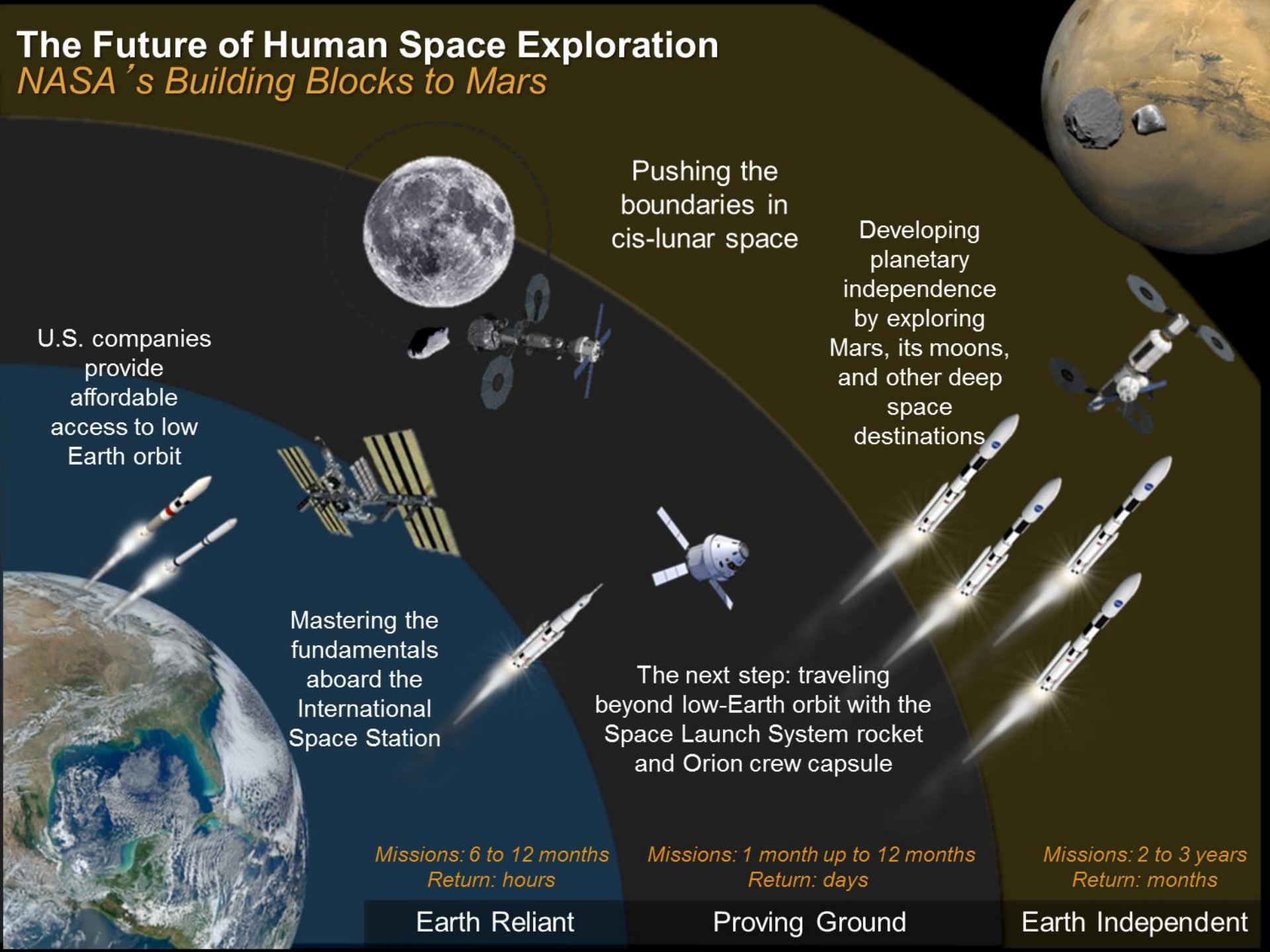

# Human Spaceflight in Low Earth Orbit (LEO)

## ▪ Low Earth Orbit (LEO)

### Challenges:

- Spacecraft design to endure harsh flight environments and maintain crew safety.
- Mass and volume constraints.
- Program budget constraints.
- Fluctuating flight schedule(s).
- Complex program level systems engineering.



**45 MINUTES TO EARTH**



# International Space Station

**AS BIG AS A FOOTBALL FIELD**

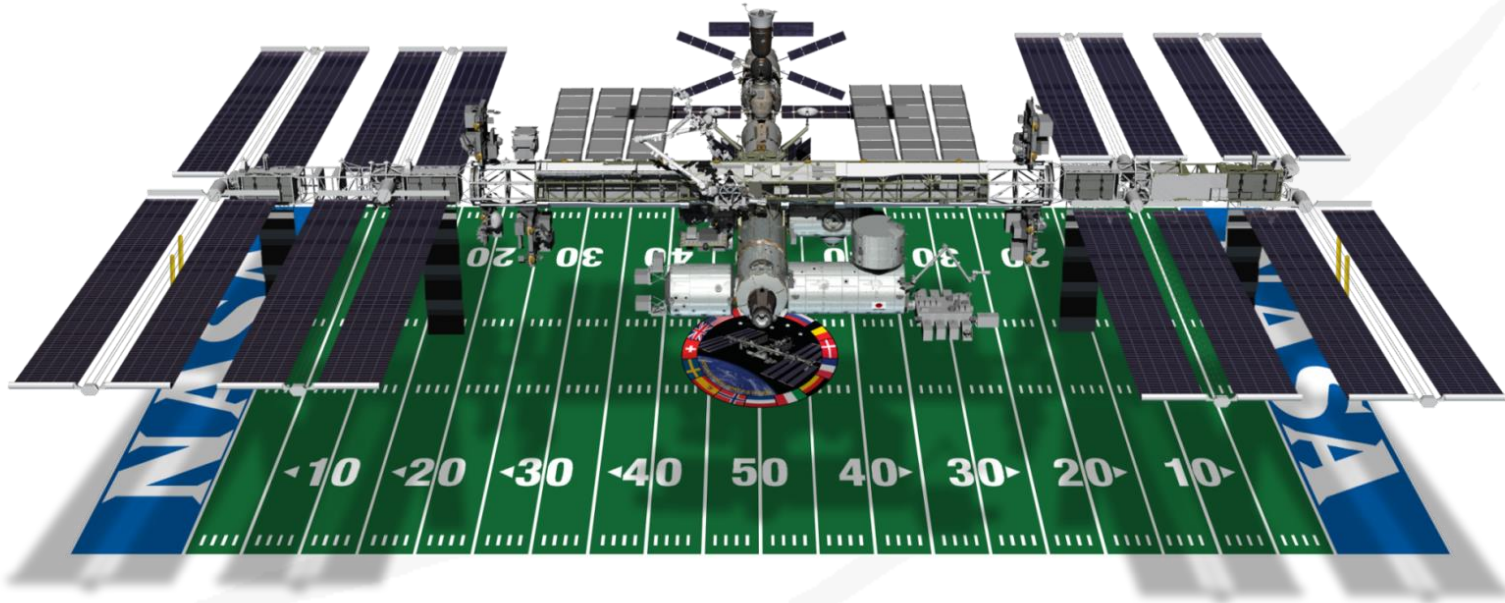

**5 Space Agencies Representing 15 Countries**

**Completion: ~1 million lb (~454,000 kg)**

**Velocity: 17,500 mph (28,100 kph)**

**Altitude: 220 miles (350 km) above Earth**

**Every day, station travels the equivalent distance to the moon and back seeing:**

**16 sunrises / 16 sunsets**

**24 hours a day**

**7 days a week**

**365 days a year**

**Requires Extensive Logistics & Maintenance**



# International Space Station

## LIVING AND WORKING IN ORBIT

ON THE INTERNATIONAL SPACE STATION



CREWS HAVE EATEN ABOUT  
**25,000 MEALS**  
SINCE THE FIRST CREW IN 2000

APPROXIMATELY  
**SEVEN TONS**  
OF SUPPLIES SUPPORT **A CREW OF THREE** FOR ABOUT  
**SIX MONTHS**



**SPACEWALKING**  
ASTRONAUTS AND COSMONAUTS  
HAVE SPENT MORE THAN **1,000 HOURS**  
WORKING OUTSIDE THE STATION

MORE THAN **1,500 SCIENTIFIC INVESTIGATIONS**  
PERFORMED ON THE INTERNATIONAL SPACE STATION



## INTERNATIONAL SPACE STATION BENEFITS FOR HUMANITY

**ADVANCED  
ROBOTIC SURGERY**

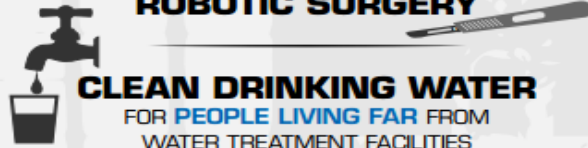

**CLEAN DRINKING WATER**  
FOR **PEOPLE LIVING FAR** FROM  
WATER TREATMENT FACILITIES

**REMOTE  
MEDICAL DIAGNOSTICS**



**EDUCATIONAL EVENTS**  
**42 MILLION** STUDENTS REACHED

## MICROGRAVITY AND LOW-EARTH ORBIT RESEARCH LABORATORY

CONDUCTING EXPERIMENTS IN:



**HUMAN RESEARCH**

**LIFE SCIENCES**



**PHYSICAL SCIENCES**

**EARTH SCIENCES**



**ASTROPHYSICS**

**TECHNOLOGY RESEARCH**



ONE THING YOU CAN SAY ABOUT THE INTERNATIONAL SPACE STATION

## IT'S BIG



**LARGER THAN A  
6-BEDROOM HOUSE**

**INTERNAL VOLUME OF A  
BOEING 747**

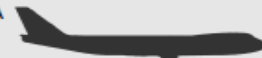

**WEIGHS ALMOST A  
MILLION POUNDS**  
(EQUIVALENT TO MORE THAN 320 AUTOMOBILES)

**TRAVELS THE EQUIVALENT DISTANCE  
TO THE MOON AND BACK**  
IN ABOUT A **DAY**





# ISS Top Research Accomplishment



- **New Targeted Method of Chemotherapy Drug Delivery**
- **Robotic Assist for Brain Surgery**
- **Understanding Mechanisms of Osteoporosis and New Drug Treatments**
- **Developing Improved Vaccines**
- **Improving Eye Surgery with Space hardware**
- **43 Million Students and Counting Touched by ISS Education**

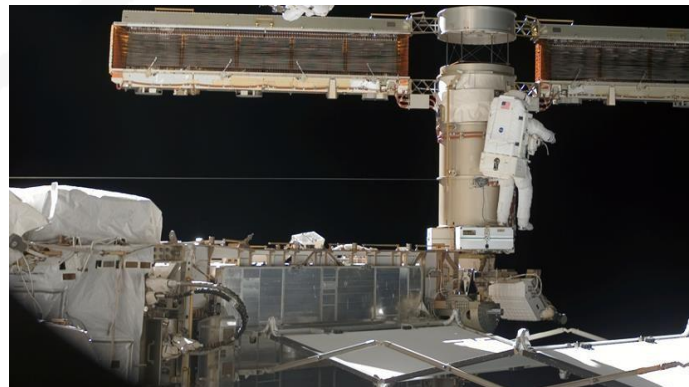
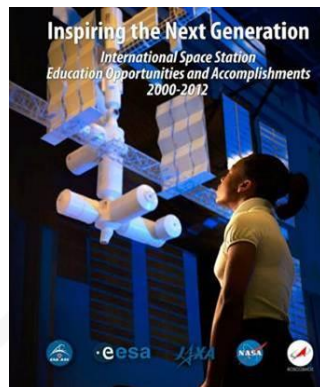
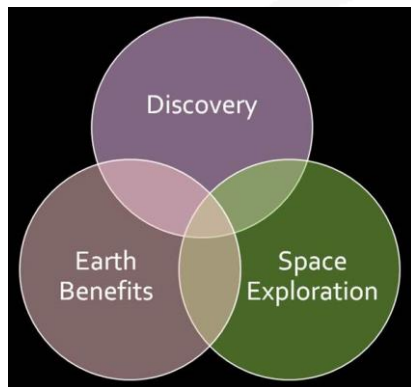

# Commercial Spaceflight Programs

## Low Earth Orbit Access

### Commercial Cargo

Facilitate U.S. private industry development of safe, reliable, and cost effective cargo space transportation capabilities to low-Earth orbit and the International Space Station.

- Two companies (SpaceX and Orbital Sciences) have successfully completed ISS cargo missions to date.

### Commercial Crew

Commercial Crew Program (CCP) is an innovative partnership to help the aerospace industry in the United States develop space transportation systems that can safely launch humans to low-Earth orbit and to the International Space Station in a safe, reliable, and cost effective way.

- JSC Engineering provides technical insight/oversight, recommendations, and shared practices for safety and mission success.





## ▪ Beyond Earth Orbit (BEO)

### Challenges:

- Spacecraft design to endure harsh flight environments and maintain crew safety.
- Spacecraft resupply for BEO missions not feasible.
- Increased reliability due to harsh radiation environment.
- Program budget constraints.
- Fluctuating flight schedule(s).
- Complex program level systems engineering.
- Mass and volume constraints.

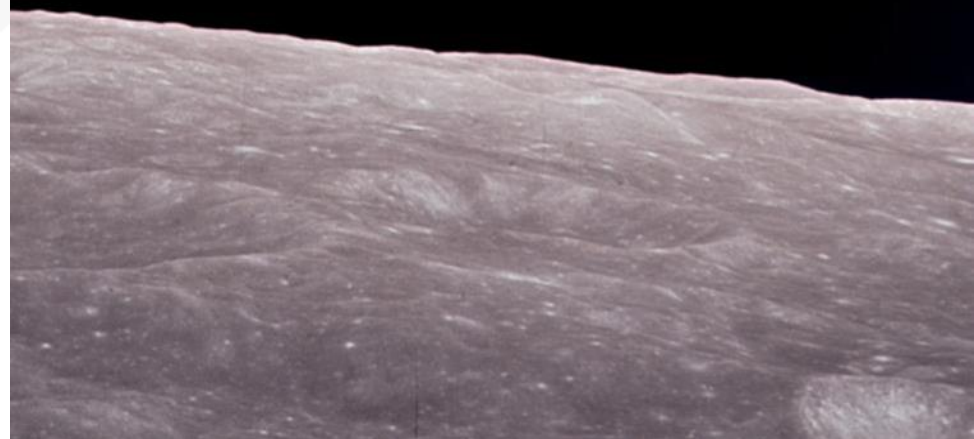

**5 TO 11 DAYS TO EARTH**

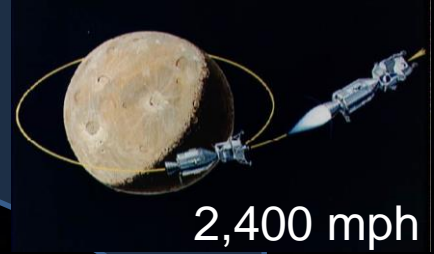
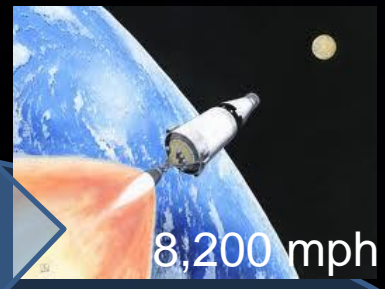

# 42,000 mph

3,900 mph

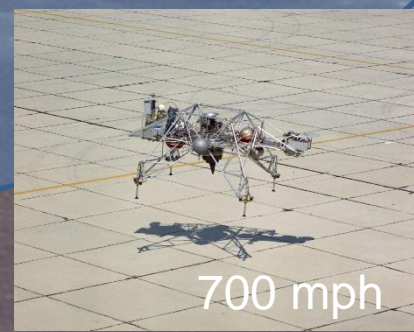
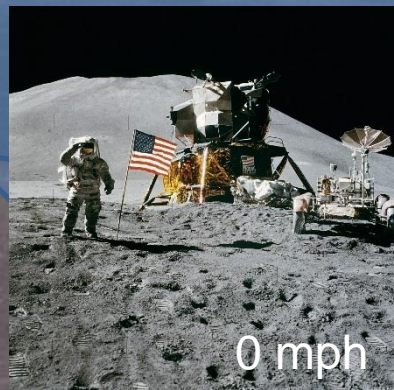
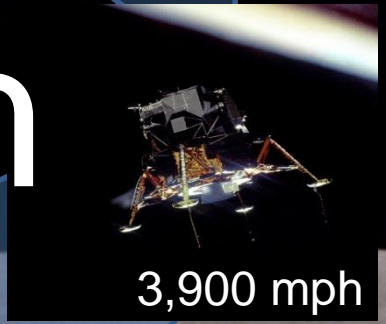

# Energy Required

0 mph

0 mph

8,200 mph

2,400 mph

2,400 mph

# 42,000 mph

3,900 mph

3,900 mph

700 mph

700 mph

0 mph

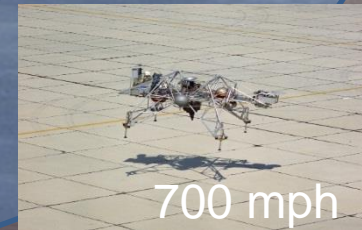
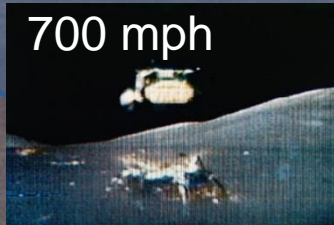
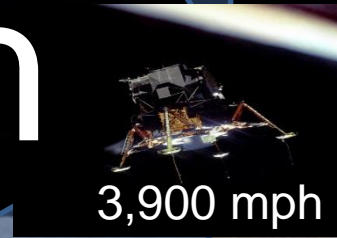
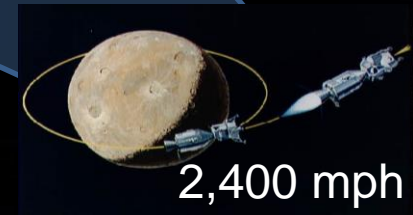
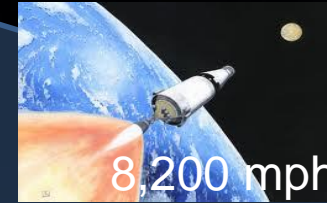



# Space Launch System (SLS) and Orion

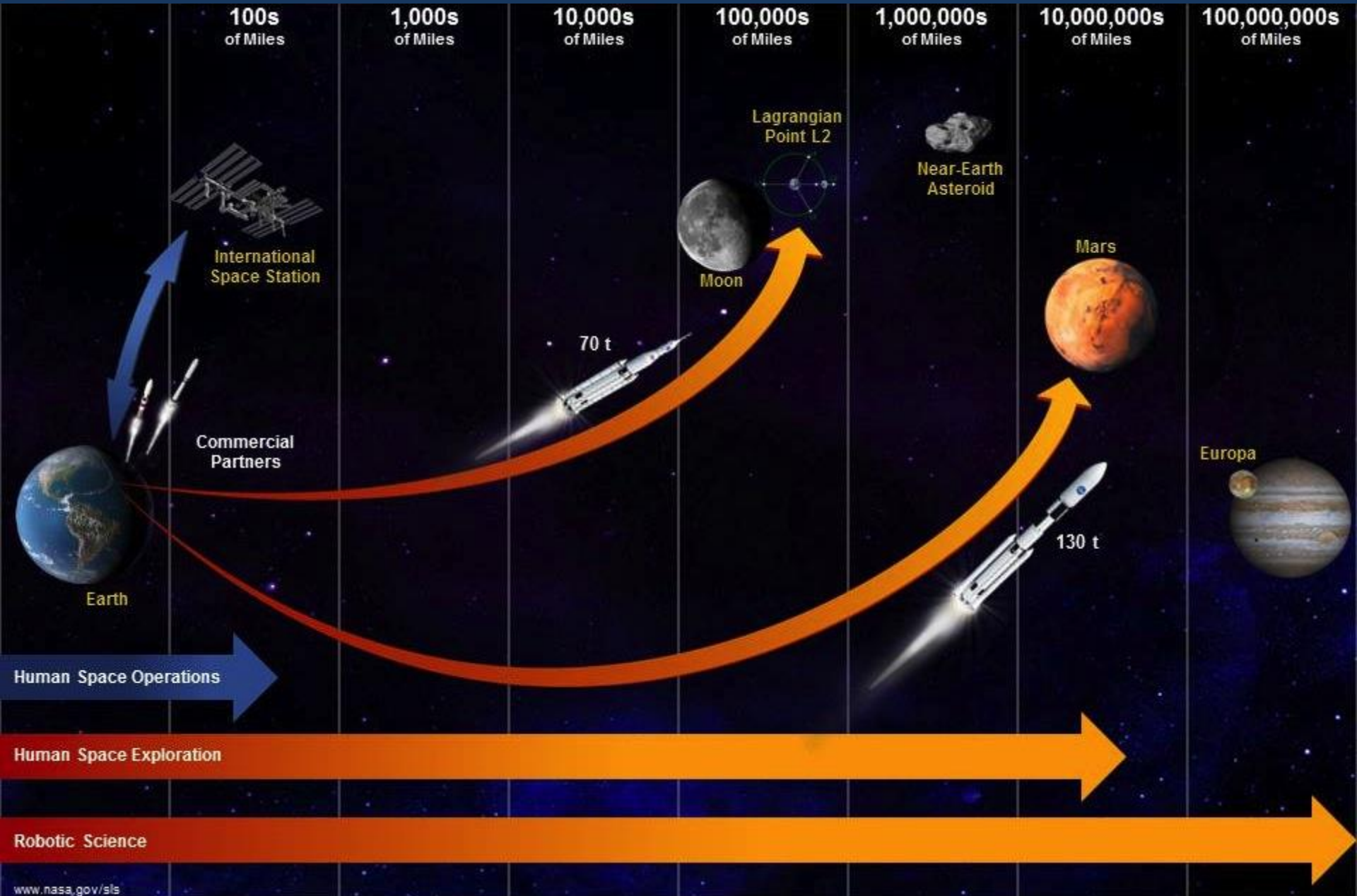



# SLS Capabilities



- 1) **SLS offers far greater mass and volume lift capability than any contemporary launch vehicle. This capability allows SLS to perform missions that no other vehicle can carry out, shorter travel times, and greater mission assurance. SLS is not designed to compete with industry launch vehicles, but to complement them by enabling new types of missions.**
- 2) **SLS enables human exploration and decadal-class science missions:**
  - Maintains reasonable number of launches per mission
  - Simplifies on-orbit operations
  - Maximizes mission reliability
- 5) **SLS investment can be leveraged for other missions:**
  - Deep Space Exploration
  - Planetary Landers
  - Human Habitats
  - Great Observatories
  - Space Solar Power
  - Outer Planet Missions
  - Department of Defense/NRO Payloads



# Most Capable U.S. Launch Vehicle

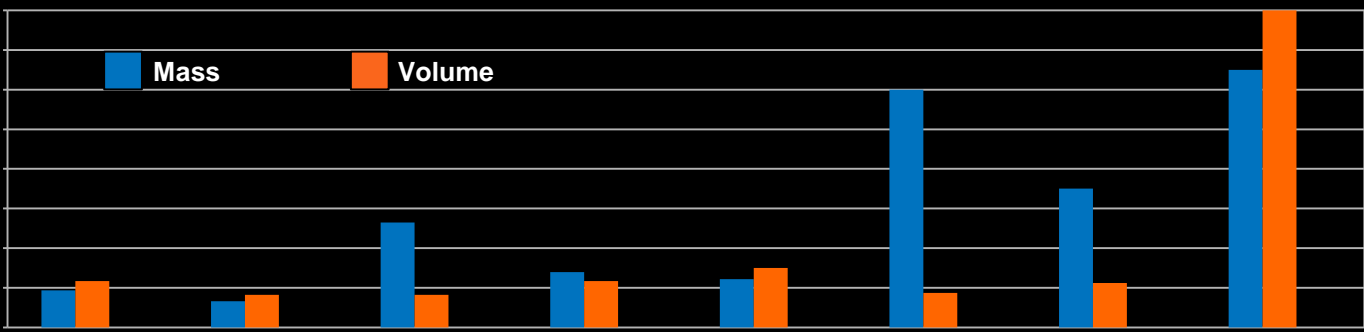
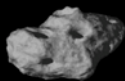
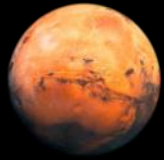
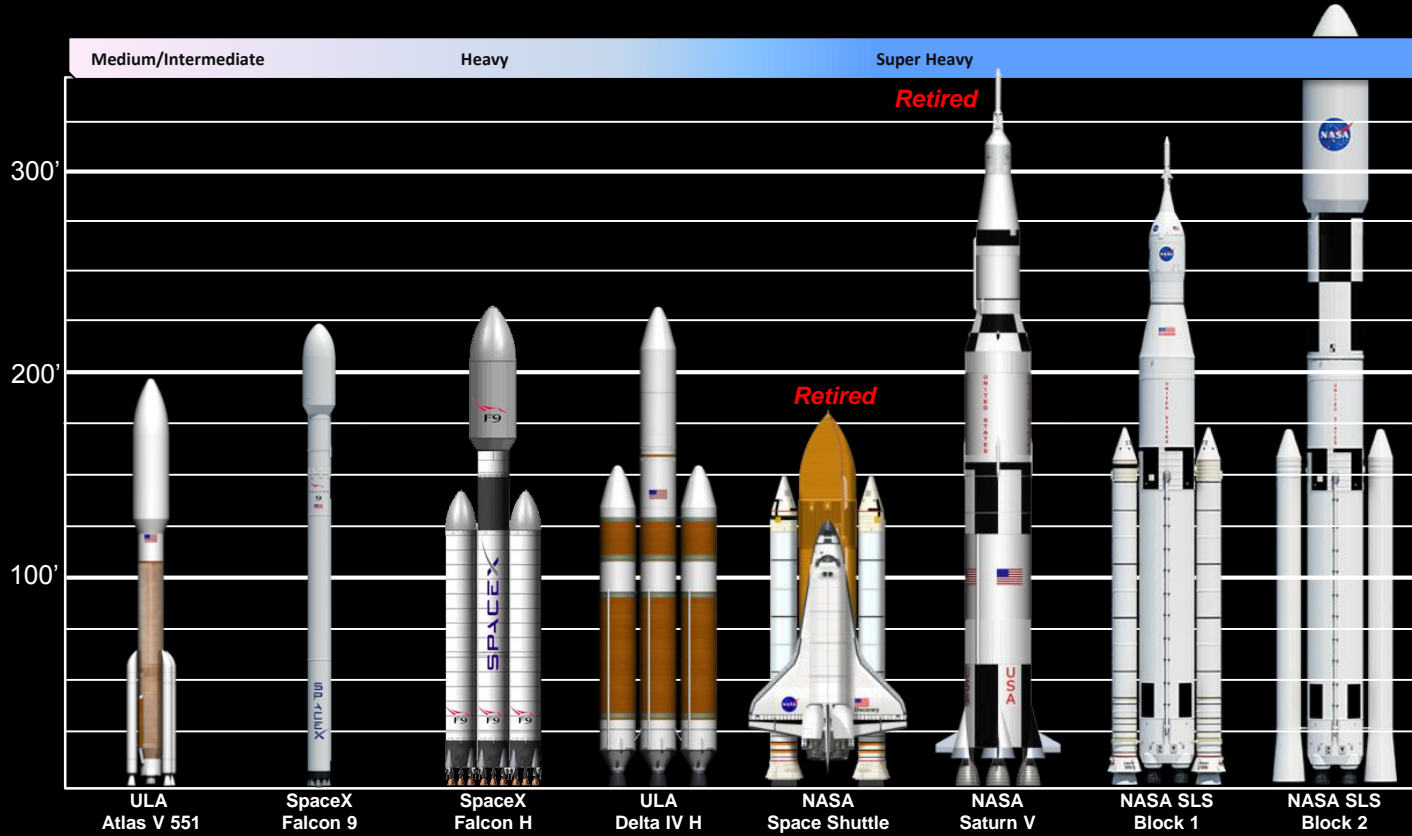



# The World's Most Powerful Rocket

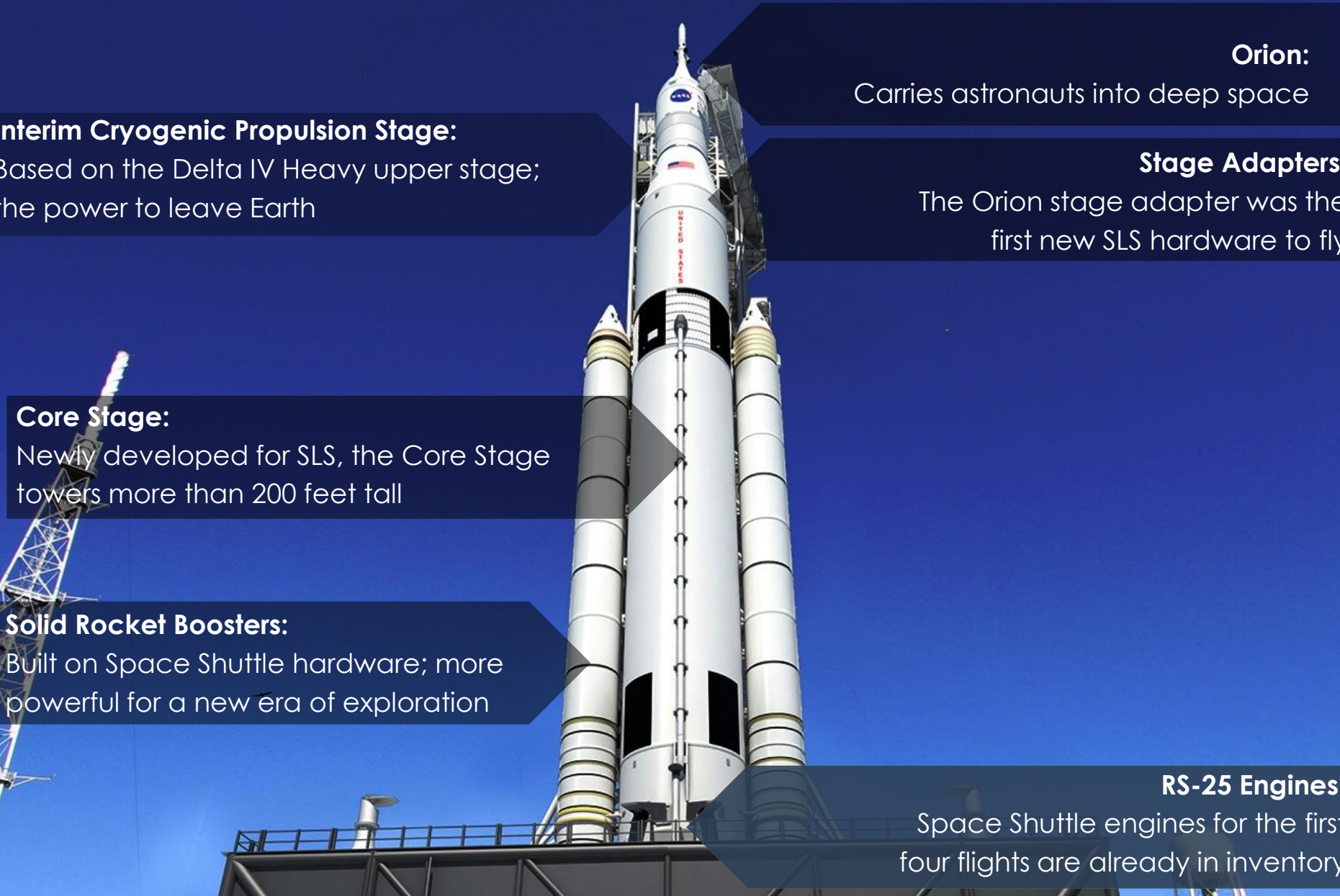

## Orion:

Carries astronauts into deep space

## Stage Adapters:

The Orion stage adapter was the first new SLS hardware to fly

## Interim Cryogenic Propulsion Stage:

Based on the Delta IV Heavy upper stage; the power to leave Earth

## Core Stage:

Newly developed for SLS, the Core Stage towers more than 200 feet tall

## Solid Rocket Boosters:

Built on Space Shuttle hardware; more powerful for a new era of exploration

## RS-25 Engines:

Space Shuttle engines for the first four flights are already in inventory



# The Orion Spacecraft

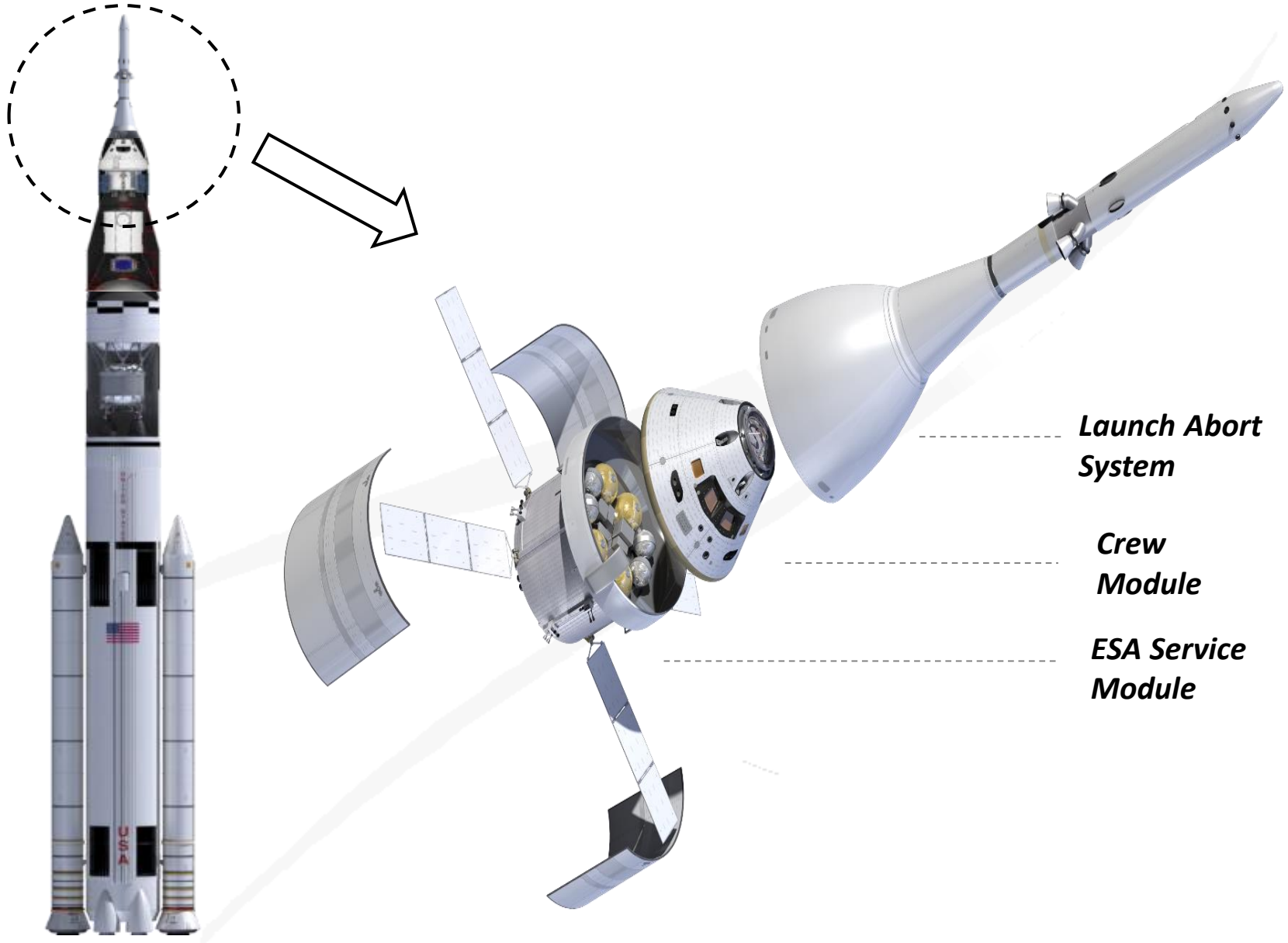

***Launch Abort System***

***Crew Module***

***ESA Service Module***



## Orion is built for going Beyond Earth Orbit

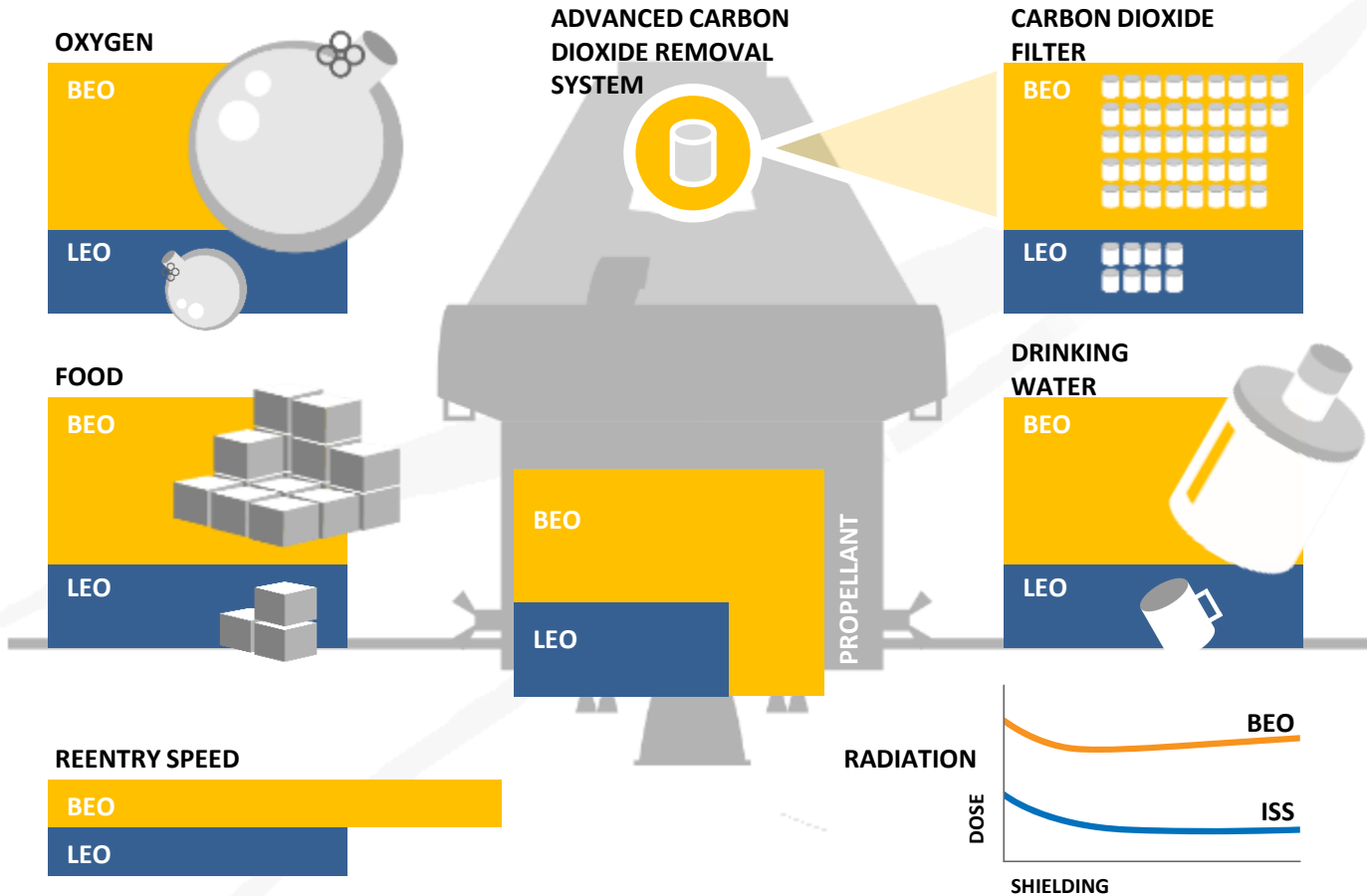

LEO: Low Earth Orbit  
 BEO: Beyond Earth Orbit



# ESA's Contribution to Orion

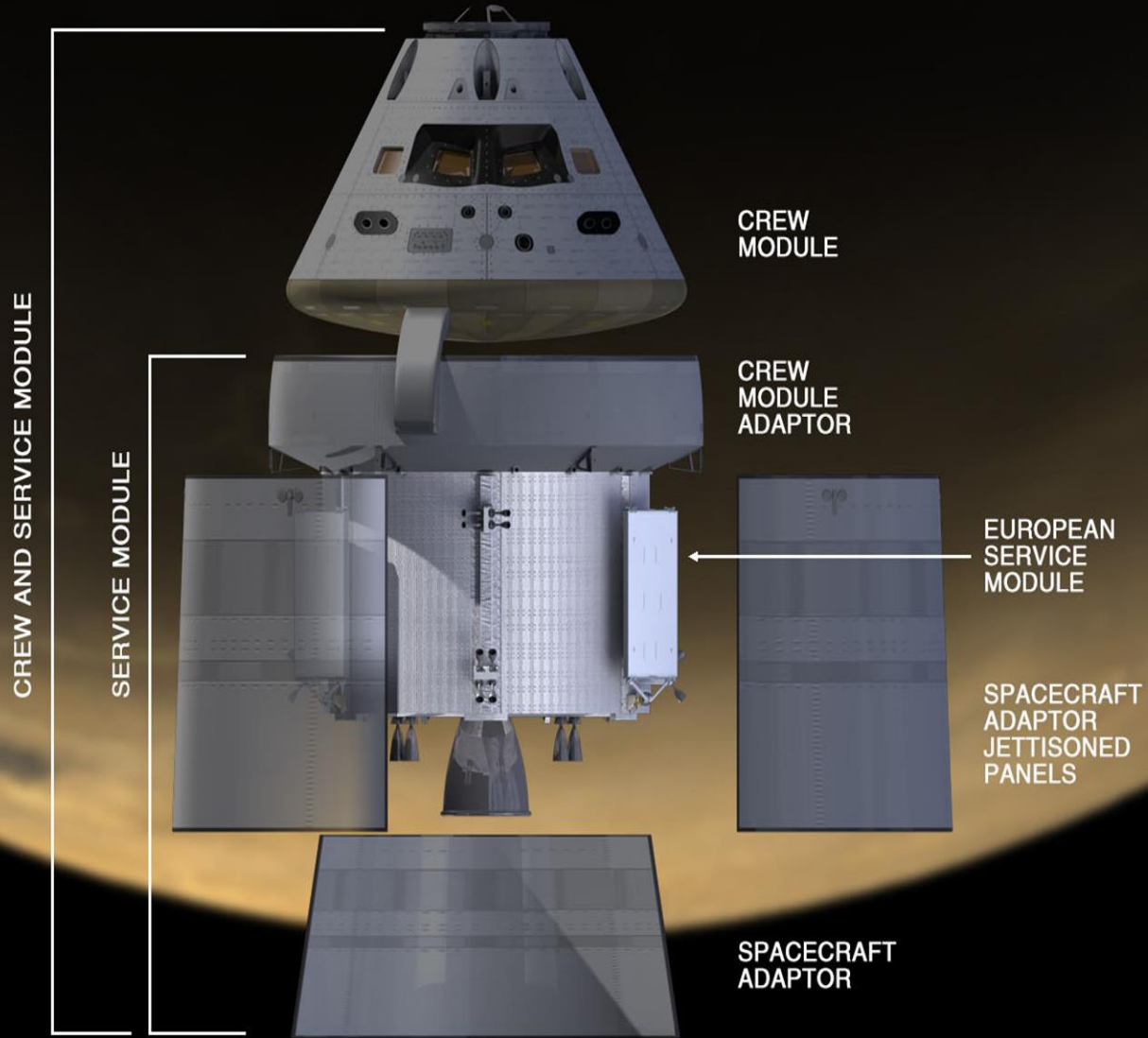

# European Service Module

## Service Module (SM) Functions & Configuration

The SM, comprised of two subcomponents the Crew Module Adapter (CMA) and the European Service Module (ESM), provides services to the CM in the form of propulsion, consumables storage, heat rejection and power generation.

- Provide in-space translational delta-V capability to transfer the vehicle Provide orbital maintenance and attitude control
- Provide high altitude ascent abort propulsion after LAS jettison
- Provide consumables to support in-space habitable environment while attached to the CM (Water, O<sub>2</sub>, and N<sub>2</sub> storage)
- Provide power generation and storage required for in-space flight
- Provide primary thermal control while mated with CM

## Spacecraft Adapter (SA/SAJ) Functions

- Provide structural connection to the launch vehicle from ground operations through orbital injection
- Provide protection for SM components from atmospheric loads and heating during first stage flight

**Crew Module Adapter (CMA)**

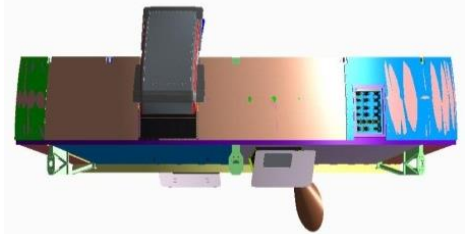

**European Service Module (ESM)**

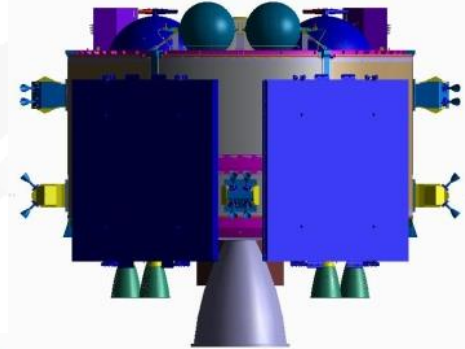

**SA Jettisoned (SAJ)**

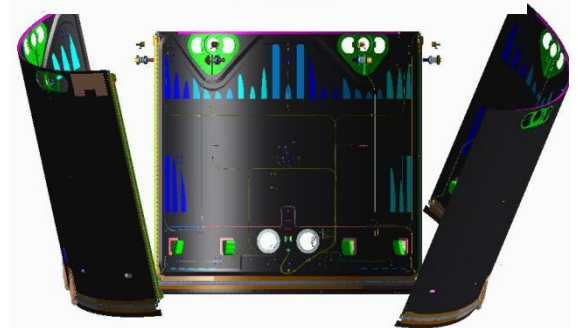

**Spacecraft Adapter (SA)**



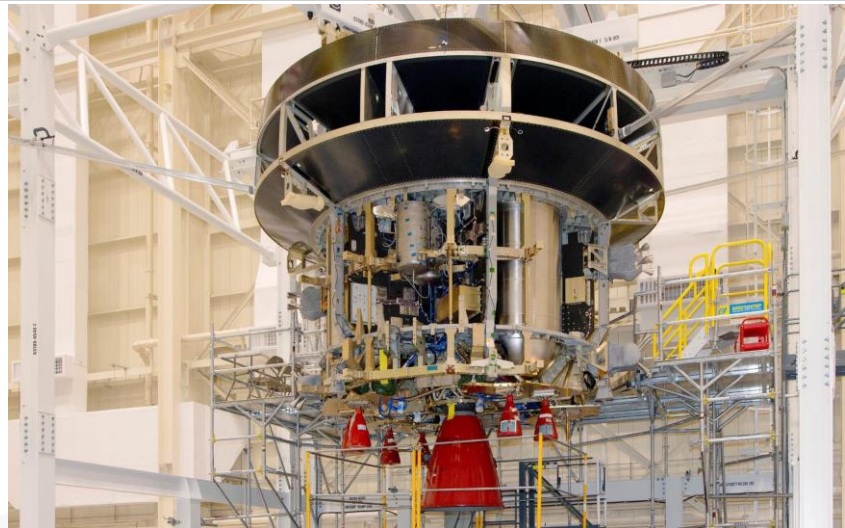

## ■ **ESA's Contributions to Orion:**

- ESA is providing Orion's service module for Exploration Mission-1, when the spacecraft will launch atop the SLS rocket and venture 40,000 miles beyond the moon.
- The ESA-provided service module, built by Airbus Defense and Space, is the spacecraft's powerhouse and will supply it with in-space propulsion, power, thermal control and air and water for crew when they are aboard.
- For the first time, NASA will use a European-built system as a critical element to power an American spacecraft, extending our international cooperation from the space station into deep space.
- NASA's work with ESA expands an already strong partnership and ensures continued international collaboration on the journey to Mars.



# Trial by Fire





# Orion EFT-1 December 5, 2014



**LIFTOFF! Orion Begins New Era in Space Exploration!**



**Fairing Panel Jettison Complete**

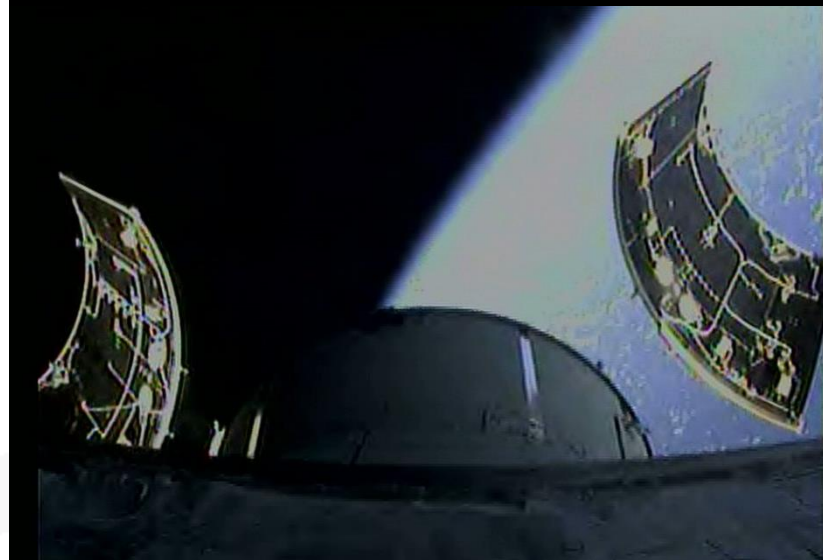

**View of Earth from On-board Orion**

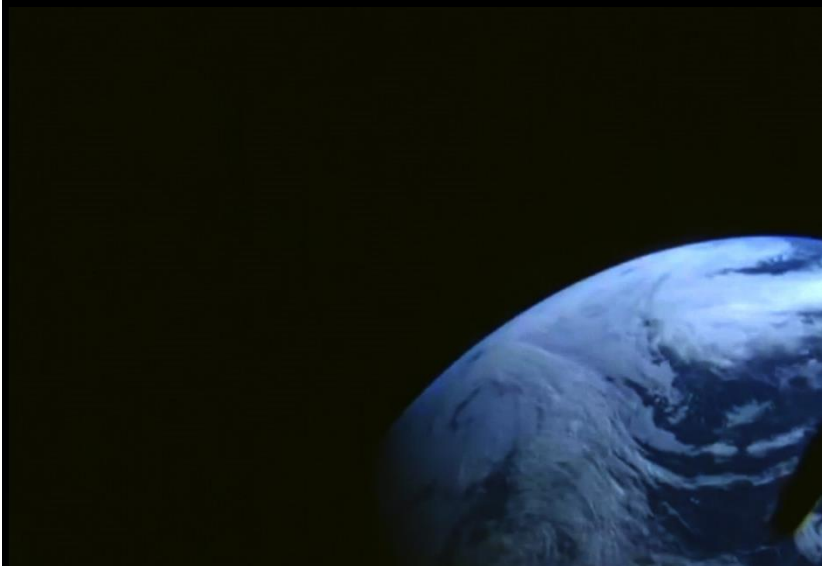

**Orion Splashdown in Pacific Ocean**





# What is necessary for successful Human Space Craft development?



- **Design complexity**
  - Systems Engineering and Integration
  - Natural Environments
  - Induced Environments
- **Mass**
- **Budget**
- **Safety**
- **Reliability**
- **Example**
  - Orion Heat Shield

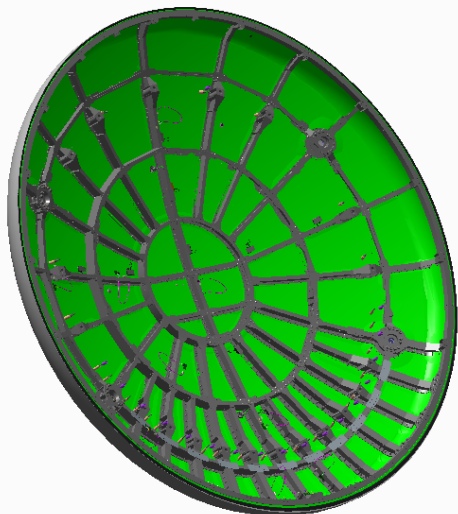

**Titanium Stringer/Skeleton**



**Carbon Laminate Skin  
(EFT1 Shown)**

**Carrier Structure**

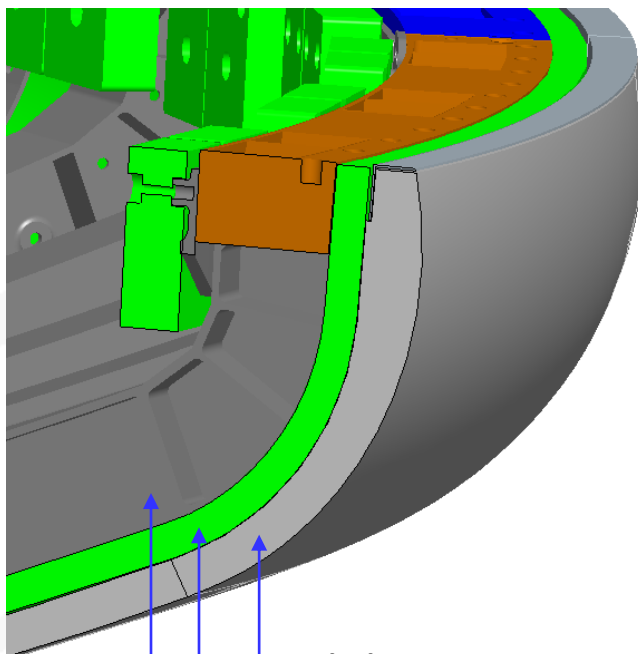
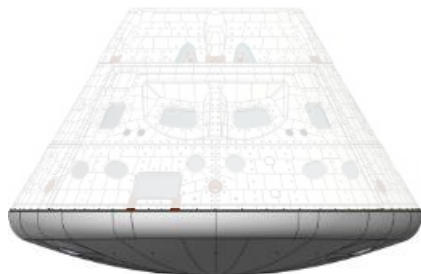

**Block AVCOAT**

**Carbon Laminate Skin**

**Titanium Stringer/Skeleton**

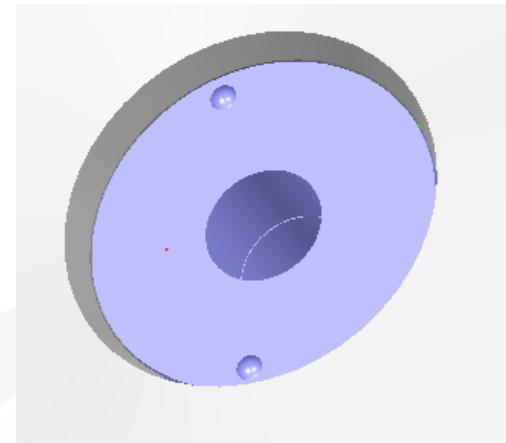

**Compression Pads, 4 Locations**

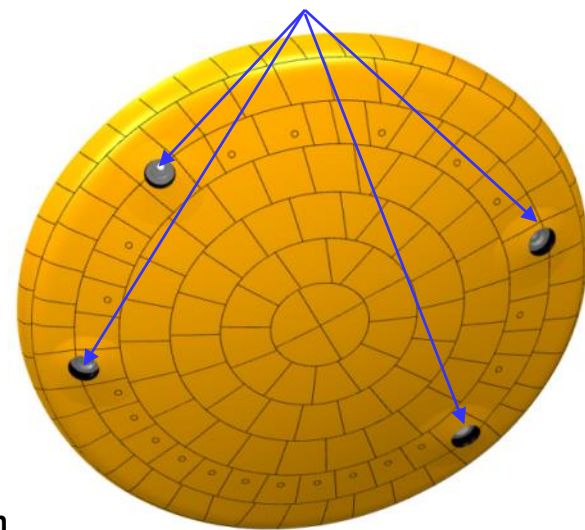

**Block AVCOAT**



## Relative Risk of TPS Failure – Environment Differences

Orbiter Reentry

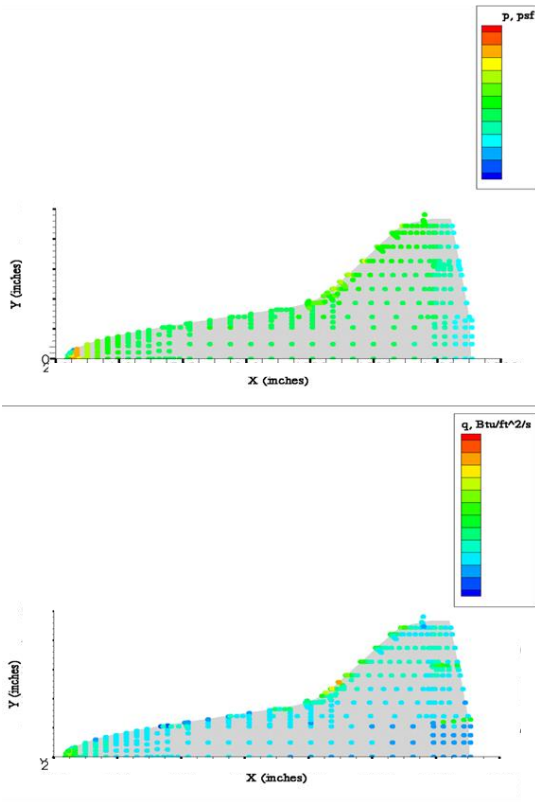

Orion Reentry

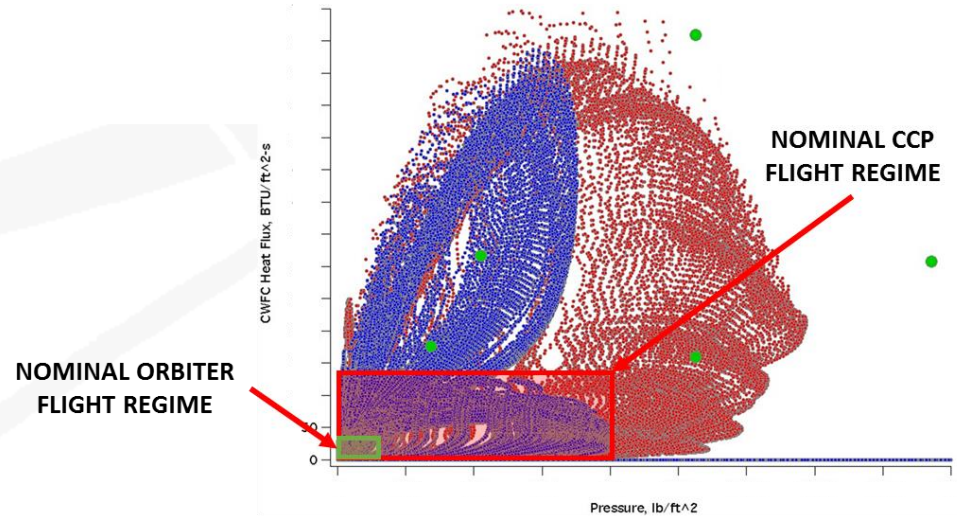

**Orion Reentry Environments more severe than Orbiter and CCP - Increased Risk**

- **ST8.1 Characteristics**

- 3-chute ascent abort (with 30° roll)
- Steep theta with moderate to high Vt
- High Vn (for three chutes)
- Low x-axis loads
- Highest z-axis loads

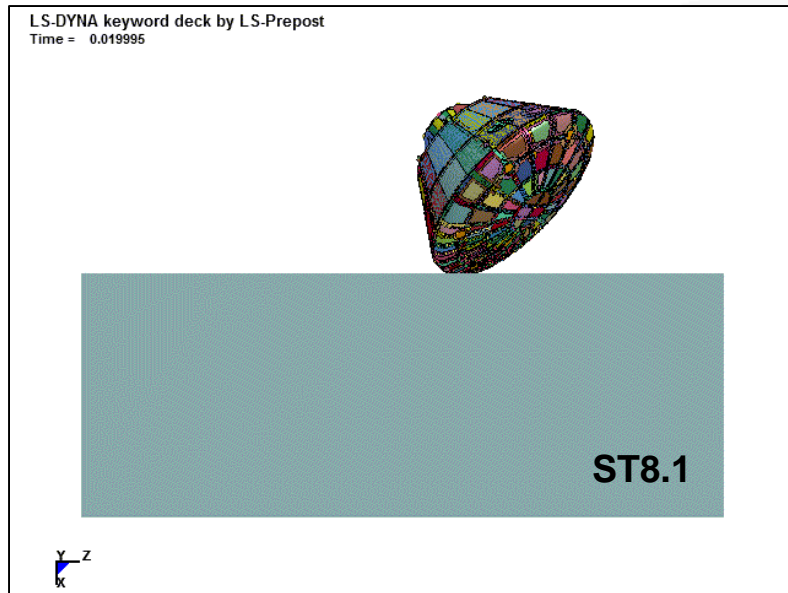

Animation by Greg Vassilakos, NASA LaRC - STC

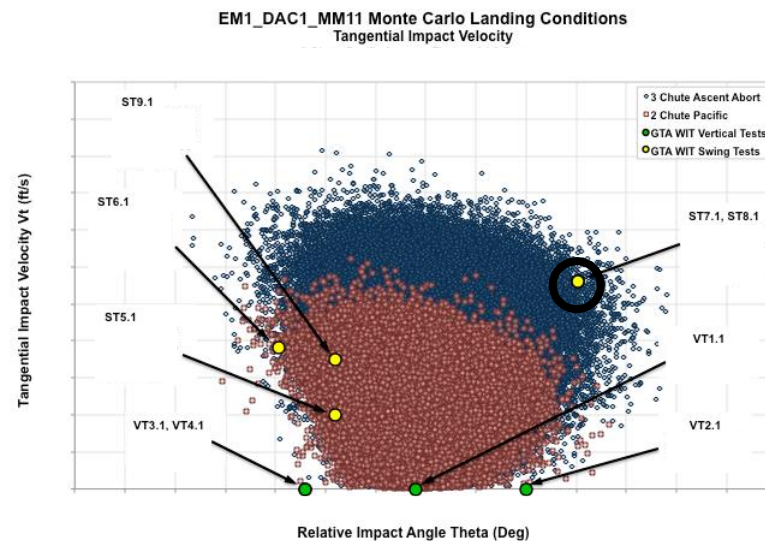
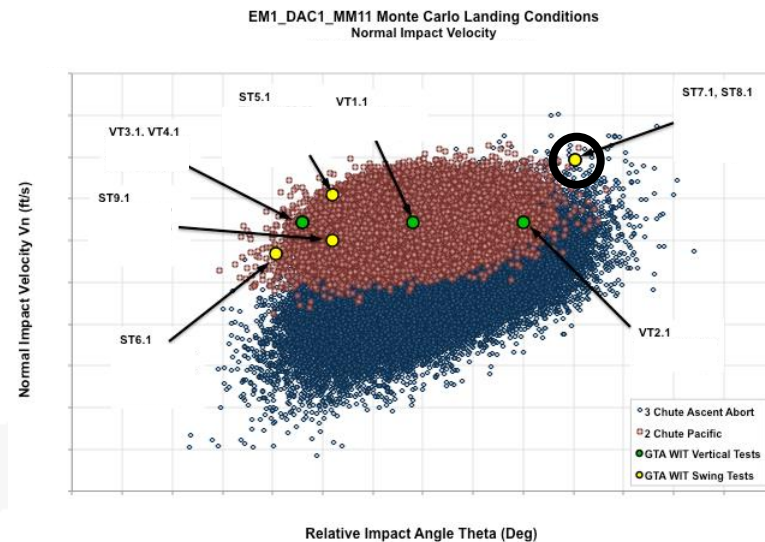

# Thermal Assessment – Gap Filler

## RTV560 with 5 pbw PMBs

High Heat flux

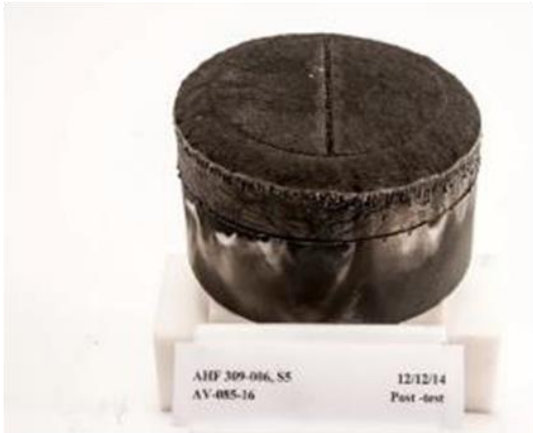

Low-med Heat



Low Heat flux



No fencing, very slight gapping

3-4 mm fence

2-3 mm fence

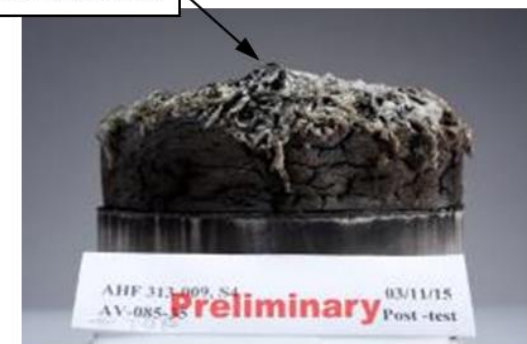
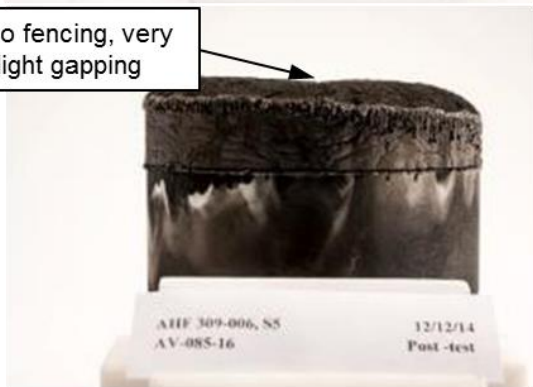

- RTV560+pmb performance is in-family with RTV560
- Gap-Filler thermal performance is successful across test range
- Upcoming tests: 40 models including stag and wedge models over the next three months.



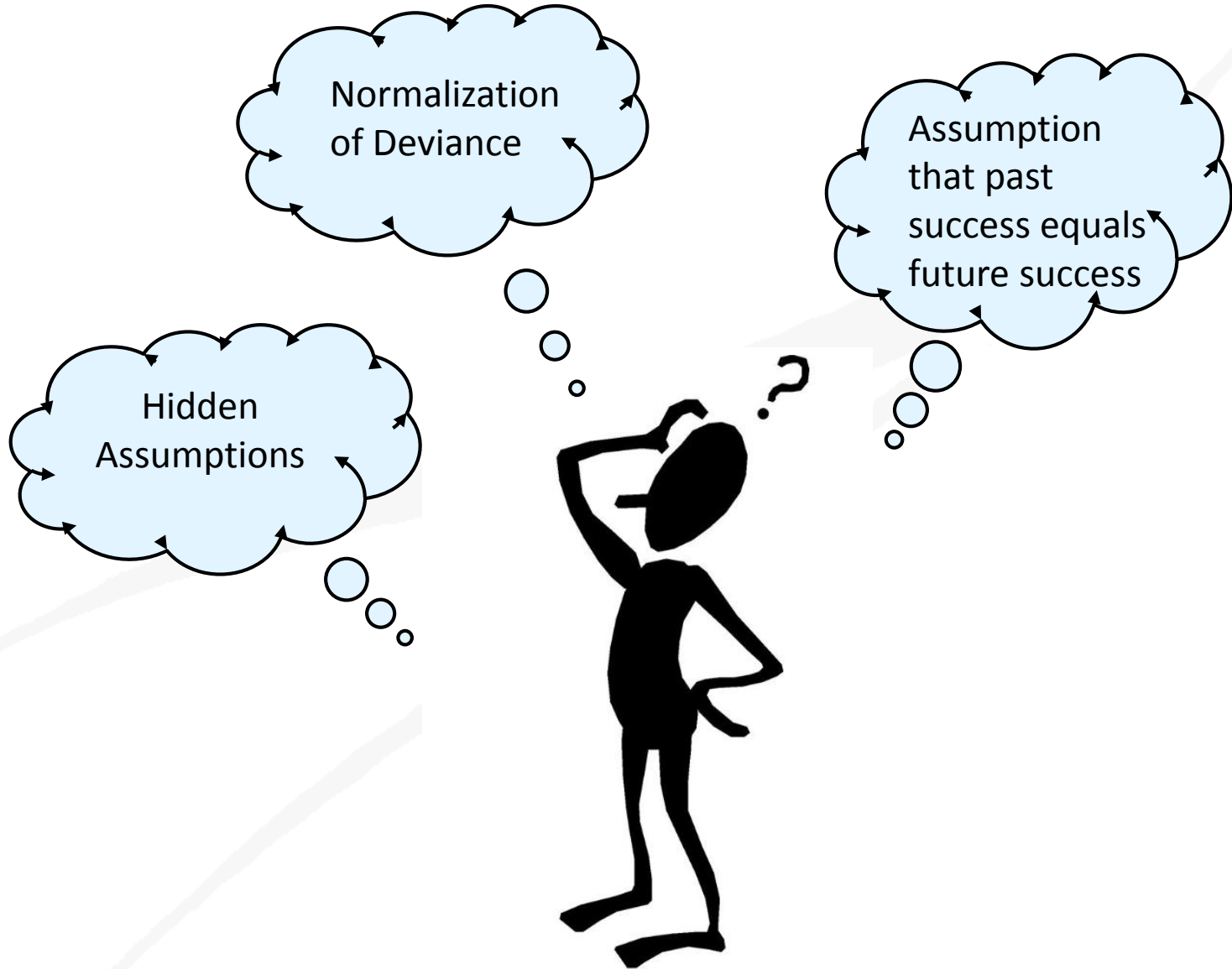

## Spaceflight is hard, but the benefits are vast

- Real technical and medical benefits for life on earth as a direct result of space research
- Technical solutions invented for spaceflight that transfer to life on earth
- International cooperation
- Science, Technology and Engineering Education
- Benefits of exploration – new discoveries and new knowledge
- <http://ntrs.nasa.gov/archive/nasa/casi.ntrs.nasa.gov/20130009008.pdf>



A faint, light gray background image of a rocket launch, showing the rocket ascending and leaving a large plume of smoke and fire.

## Questions



## Back Up Charts





## Leading Human Space Exploration



Lead Human Exploration



Lead Internationally

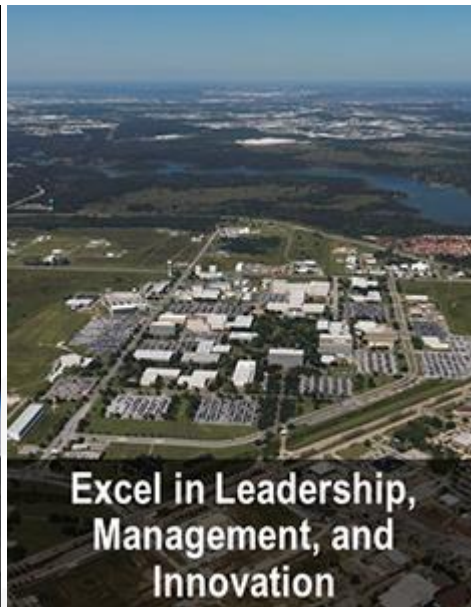

Excel in Leadership,  
Management, and  
Innovation



Expand Relevance to  
Life on Earth

**Engineering**

**Flight Operations**

**Astromaterials Research  
& Exploration Science**

**Exploration, Integration,  
and Science**

**International Space Station Program**

**Orion Multi-Purpose Crew Vehicle Program**

**Commercial Crew & Cargo Program**

**Safety & Mission Assurance**

**Human Health & Performance**

# Orion Has Been Shaped By Its History

- **Built for Beyond Earth Orbit (BEO)**
- **Synergistic with the Commercial Crew Program strategy**
- **Adapted to Significant Policy/Strategic Changes since Inception**
- **Orion/SLS combination is critical to extending human presence beyond low earth orbit**

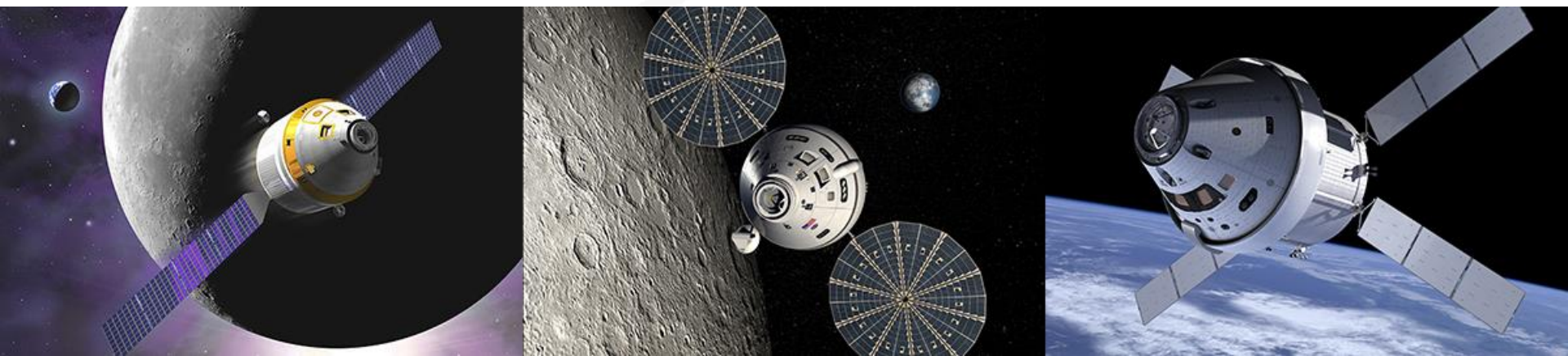

### Life Support

- High reliability systems
- O<sub>2</sub> recovery and reducing logistics
- Water recovery loop closure
- Solid waste volume reduction and resource recovery
- Store nutritionally-adequate food for years



### Space Suits

- Low mass suit and power pack
- Lower torso mobility
- Enhanced dexterity
- Compatible with Mars environment
- Increase information system capabilities
- In-situ suit repair



### Microgravity Countermeasures

- Exercise equipment for muscle and cardiovascular atrophy, and bone loss
- Low-mass, rapid deploy, low-maintenance systems



### Autonomous Medicine

- Advanced medical diagnosis, prognosis and treatment capabilities
- In-situ analysis of biomedical samples



### Environmental Control

- In-flight analysis capabilities
- Rapid detection and mitigation of environmental hazards
- Detect contaminants introduced via surface activities
- Automated recovery
- Fire suppression



### Access to Space

- Space Launch System heavy lift for large mass and volume
- Orion crew vehicle for crew delivery to and return from deep space



### Chemical Propulsion

- $O_2$ /Hydrocarbon ( $CH_4$ ) propulsion for in-space transit, landing and ascent
- Integrated main and reaction control propulsion systems
- Ability to maintain cryogenic fluids for long durations



### Advanced Propulsion

- Advanced capabilities to improve mass delivery and trip time
- Under investigation
  - Solar Electric
  - Advanced Chemical
  - Nuclear Thermal
  - Nuclear Electric

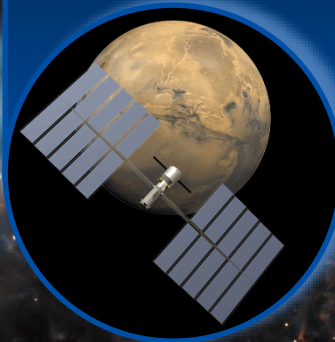

### In-Situ Resource Utilization

- Production of  $O_2$  from the atmosphere for Mars ascent
- Production of life-support consumables
- Construction of surface infrastructure from local resources

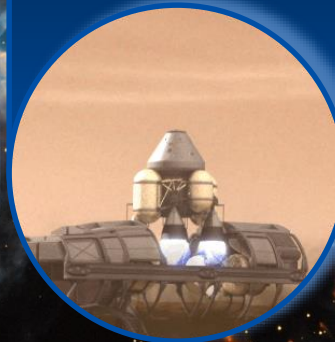

### Entry, Descent, Landing & Ascent

- Hypersonic inflatable or deployable decelerators
- Supersonic retro-propulsion
- Precision landing
- Plume blast mitigation
- High-speed Earth re-entry
- Occupant protection

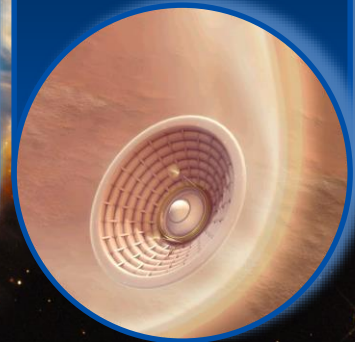

# Mars Challenges

## Technology Focus for Working in Space

### Humans & Robots Working Together

- Human/machine coordination to improve productivity & reduce risk
- Robots performing routine tasks (inspection, logistics)
- Robotic Explorers (reconnaissance and risk reduction)



### Autonomous Operations

- Independent, self-reliant crew can operate with up to 40 minute time delay
- Highly automated vehicle operable by minimal crew
- MCC automation (strategic/analysis role)
- Automated rendezvous & docking



### In-Flight Maintenance

- Component-based design for maintainability & reliability
- Vehicle-wide diagnostics, prognostics & recovery
- In-space repair & manufacturing



### Exploration Mobility

- Routine surface exploration
- Maximize time spent and distance traveled
- Minimize "time to get out the door"
- Environmental protection including dust abatement



### Power Generation

- Production of high, continuous, latitude independent power for crew operations
- Mobile power systems for robust exploration

