



# Monitoring Atmospheric CO<sub>2</sub> from Space: Challenge & approach

Bing Lin<sup>1</sup>, F. Wallace Harrison<sup>1</sup>, Amin Nehrir<sup>1</sup>, Edward  
Browell<sup>2</sup>, Jeremy Dobler<sup>3</sup>, Joel Campbell<sup>1</sup>, Byron  
Meadows<sup>1</sup>, Michael Obland<sup>1</sup>, Susan Kooi<sup>4</sup>, Tai-Fang Fan<sup>4</sup>,  
Syed Ismail<sup>1</sup>, and LaRC ASCENDS team

<sup>1</sup>NASA Langley Research Center, Hampton, VA, USA

<sup>2</sup>NASA Langley/STARSS II Affiliate, Hampton, VA, USA

<sup>3</sup>Exelis Inc., Ft. Wayne, IN, USA

<sup>4</sup>Science System and Application, Inc, Hampton, VA, USA

The 4<sup>th</sup> International Symposium on  
Atmospheric Light Scattering and Remote Sensing  
1-5 June 2015, Wuhan, China



# Outline



## ❖ Introduction

- Carbon sciences and challenges
- Lidar CO<sub>2</sub> measurement approach
- Instrumentation

## ❖ Lidar Measurements

- CO<sub>2</sub> column measurements
- Accuracy and precision
- CO<sub>2</sub> column measurements with clouds
- Ranging measurements
- Space application

## ❖ Summary



# Grand Challenge: small changes (GEOS-5 Simulated XCO<sub>2</sub> : Day vs Night)



July 30, 21 Z

July 30, 9 Z

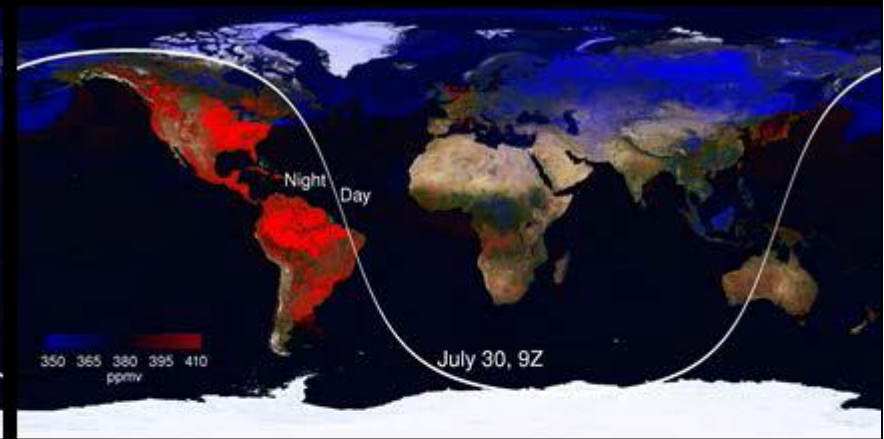
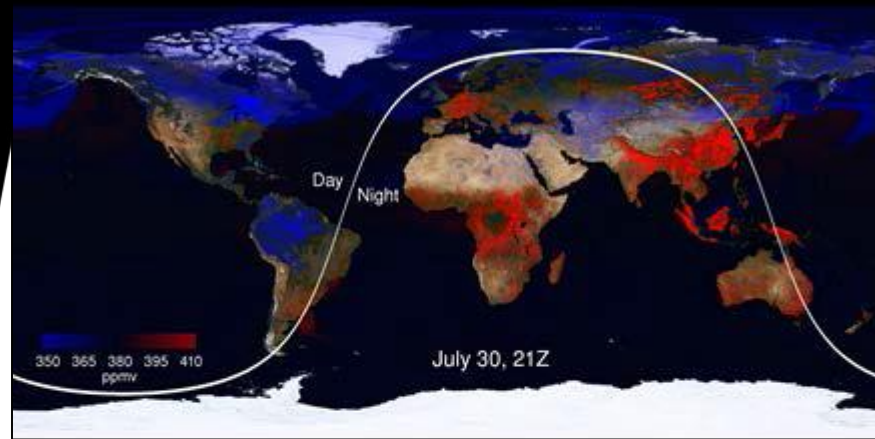

upper: surface XCO<sub>2</sub>; lower: column averaged XCO<sub>2</sub>

# CO<sub>2</sub> Measurement Architecture IM-CW Laser Absorption Lidar

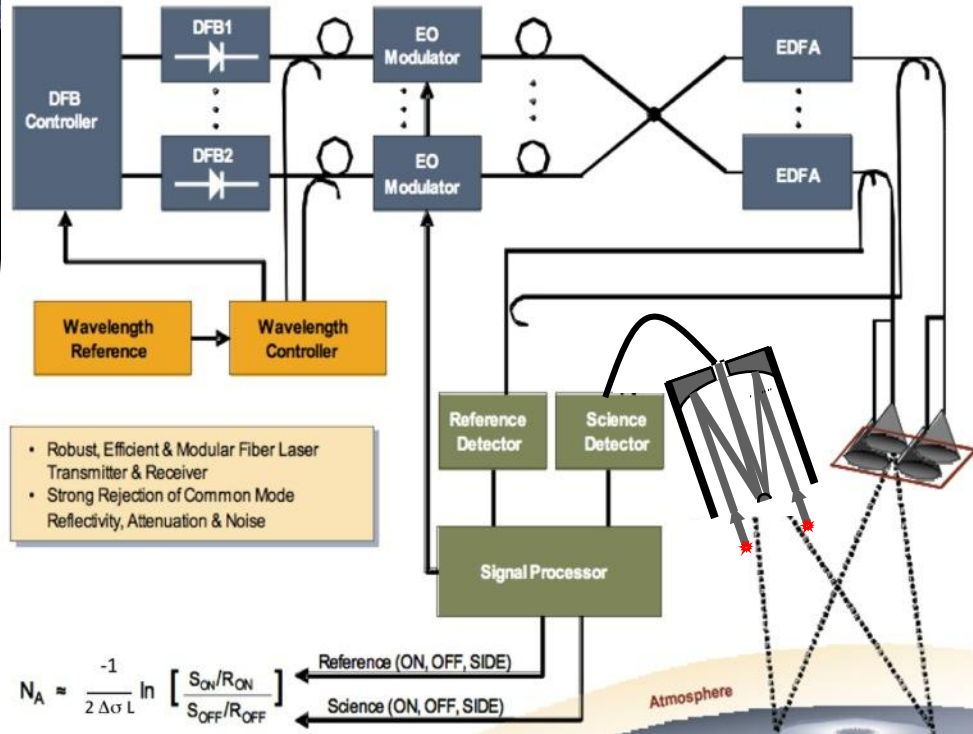

- Simultaneously transmits  $\lambda_{on}$  and  $\lambda_{off}$  reducing noise from the atmosphere and eliminating surface reflectance variations.
- Approach is independent of the system wavelength and allows simultaneous CO<sub>2</sub> & O<sub>2</sub> (1.26  $\mu$ m) measurements for deriving XCO<sub>2</sub> measurement.

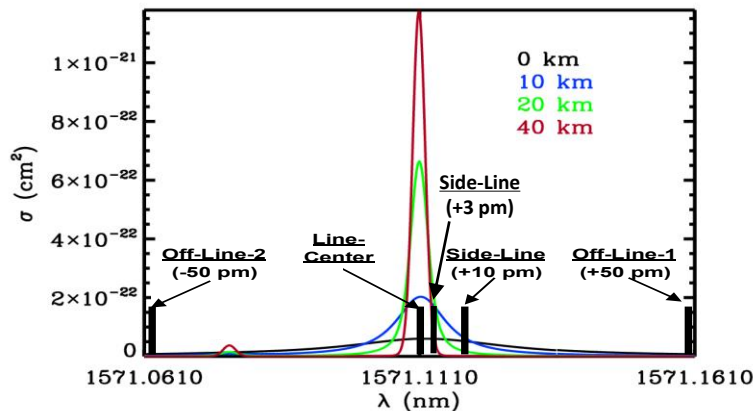

Weighting Functions

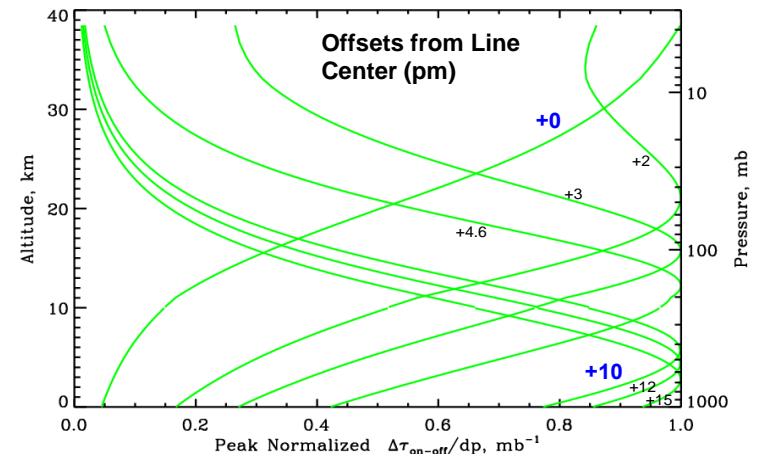





# IM-CW Laser Absorption Lidar 1.57- $\mu\text{m}$ CO<sub>2</sub> Measurement Technique

## Progression of Transmitted/Received Intensity-Modulated Waveforms

Simultaneously transmitted Intensity modulated range encoded waveforms

Simultaneously received Online and Offline IPDA returns

Measurement: Output of correlation between transmitted and received waveforms

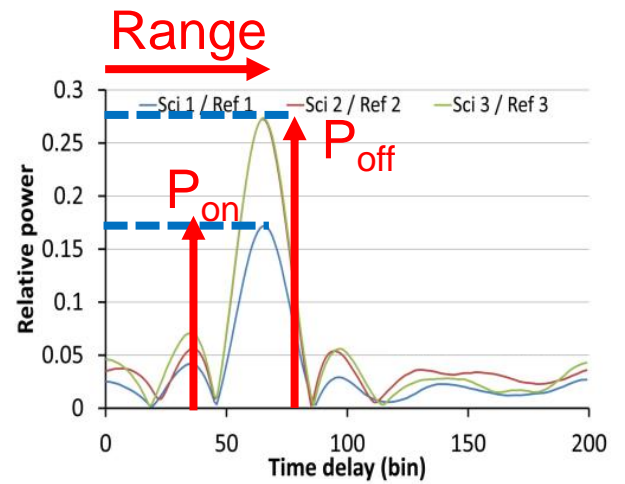
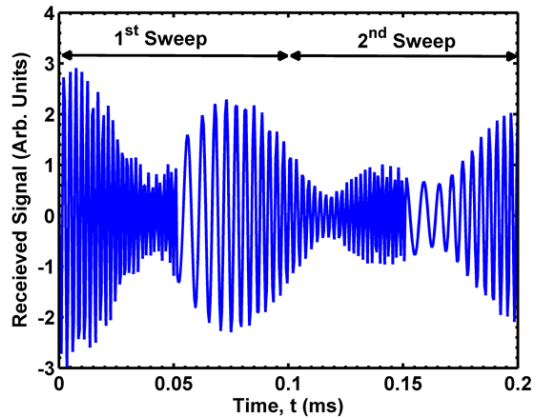
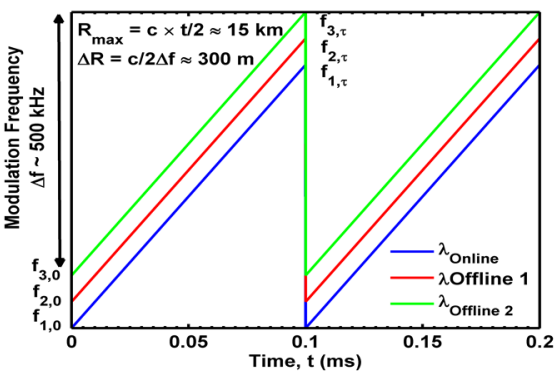

Range encoded approach for detection and ranging is analogous to mature CW Radar and GPS measurement techniques

$$DAOD = \frac{1}{2} \ln \left( \frac{P_{\text{off}} * E_{\text{on}}}{P_{\text{on}} * E_{\text{off}}} \right)$$



# Instrument Development

(Langley and Exelis; 14 MFLL + 1 ACES campaigns)



ASCENDS CarbonHawk  
Experiment Simulator  
(ACES; developed at Langley  
with support from Exelis)

Multifunctional Fiber Laser Lidar (MFLL)  
(developed by Exelis in 2004  
Exelis and Langley since 2005)

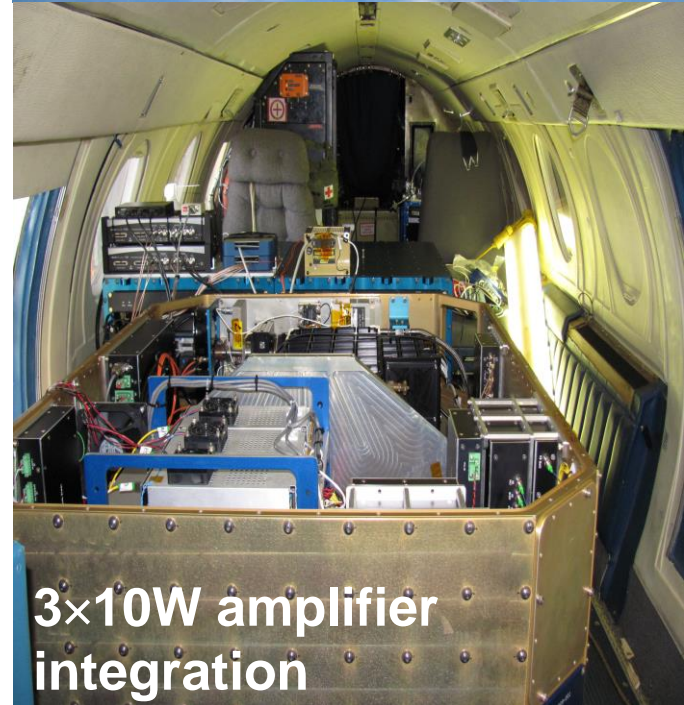

3×10W amplifier  
integration



Instrument-aircraft integration

advancing key technologies  
for spaceborne measurements  
of CO<sub>2</sub> column mixing ratio



# In Situ and Lidar Comparison

## (MFL/OCO-2 Under Flight: 20140827)



2014 AVOCET In Situ CO2

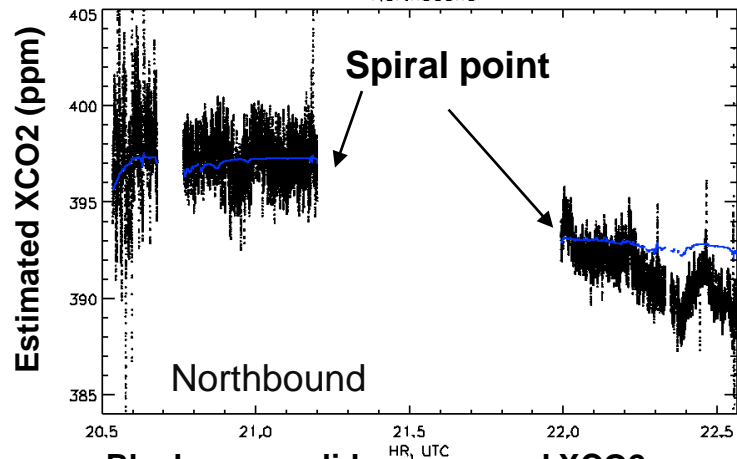
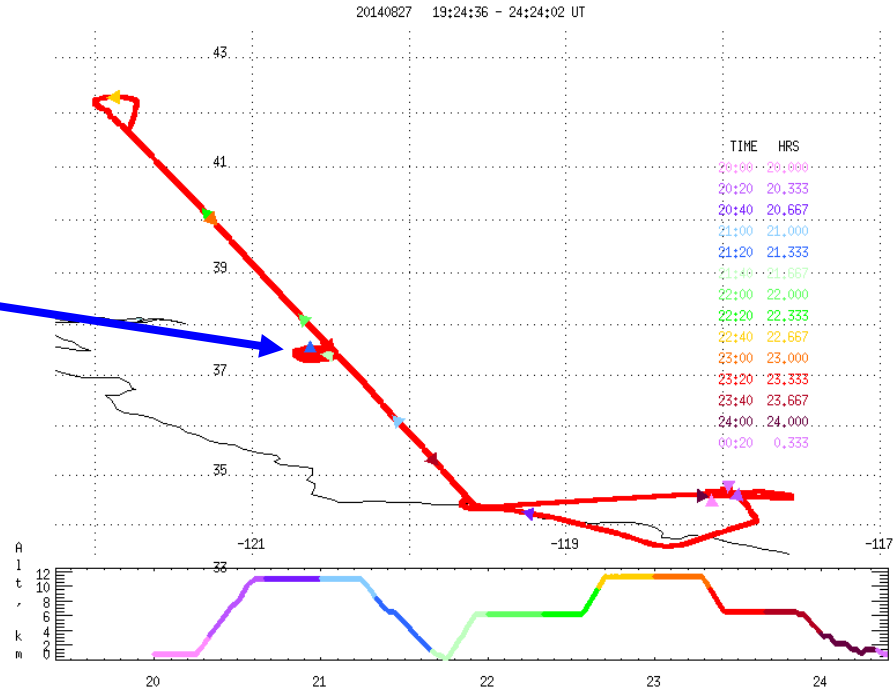
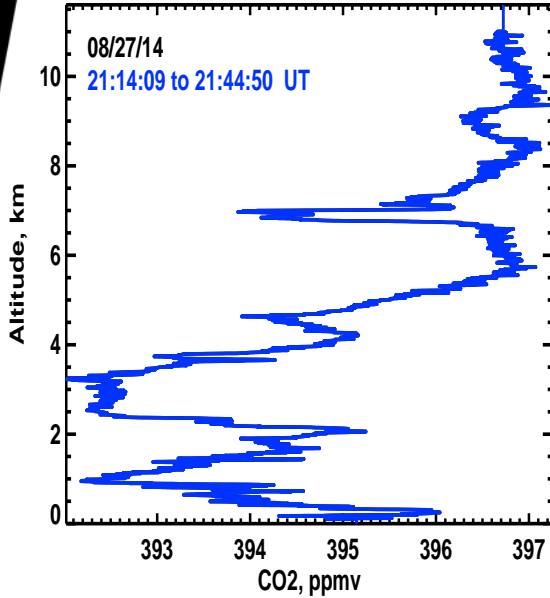

Black curves: lidar measured XCO2  
Blue curves: in-situ derived XCO2

### In-situ derived (or modeled) Value

- In-situ from Spiral: XCO<sub>2</sub>, T/p/q profiles
- Radiative transfer model
- Ranging correction with lidar range data
- In-situ derived (or modeled) DAOD
- In-situ derived (or modeled) XCO<sub>2</sub>

**difference (ppm): 0.18**





# Winter 2013 Flight Campaign

## (22 Feb. 2013 Flight: Blythe, CA)



CO<sub>2</sub> concentration (22-Feb-2013)

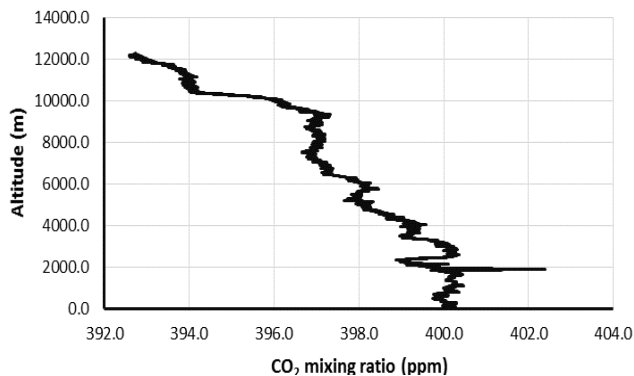

### Comparison of CO<sub>2</sub> columns from MFL measurements and in situ derived values

$$\frac{(\text{DAOD}_{\text{mea}} - \text{DAOD}_{\text{mod}})}{\text{DAOD}_{\text{mod}}} = -0.01\% \text{ ( or within 0.04 ppm)}$$

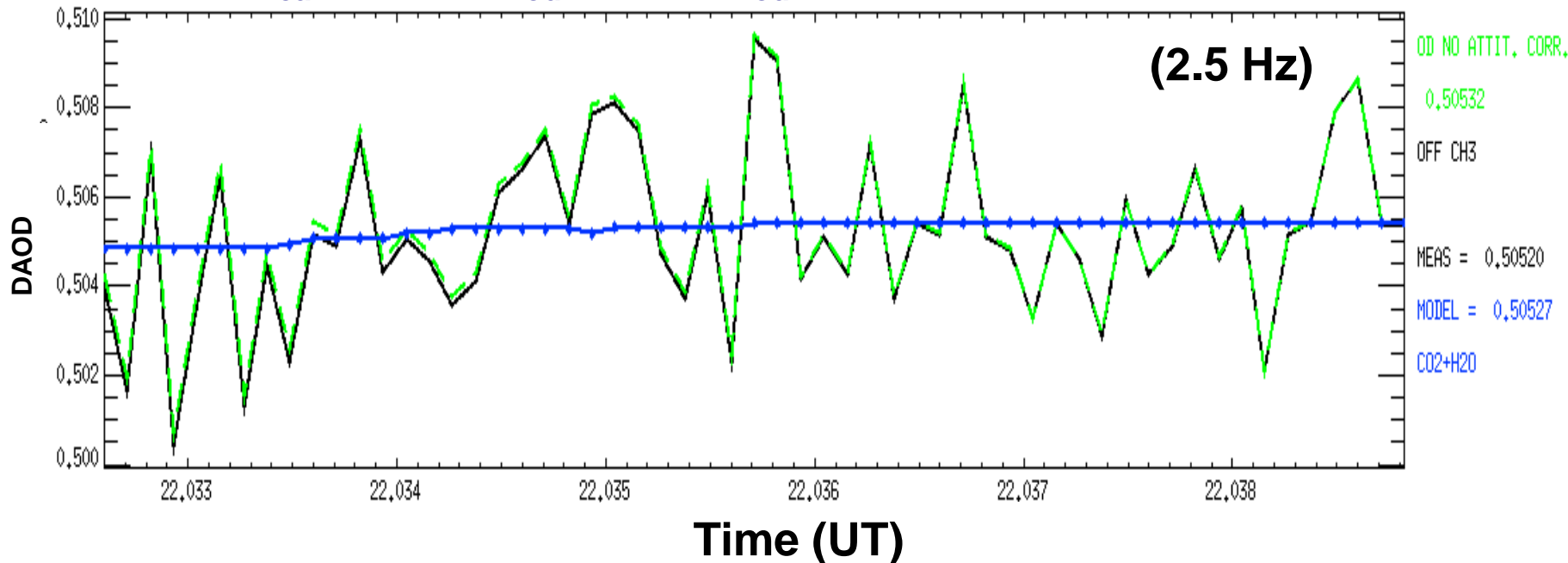



# 2011 ASCENDS DC-8 Flight Campaign (MFLC during 28 July – 11 August)



## Differential Absorption Optical Depth (DAOD) Comparisons

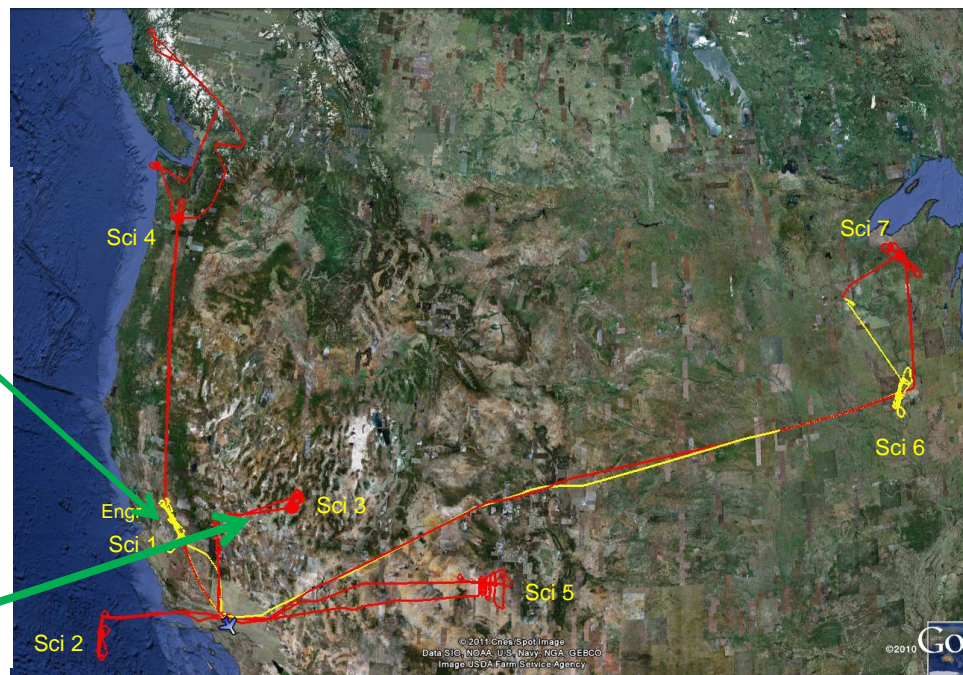
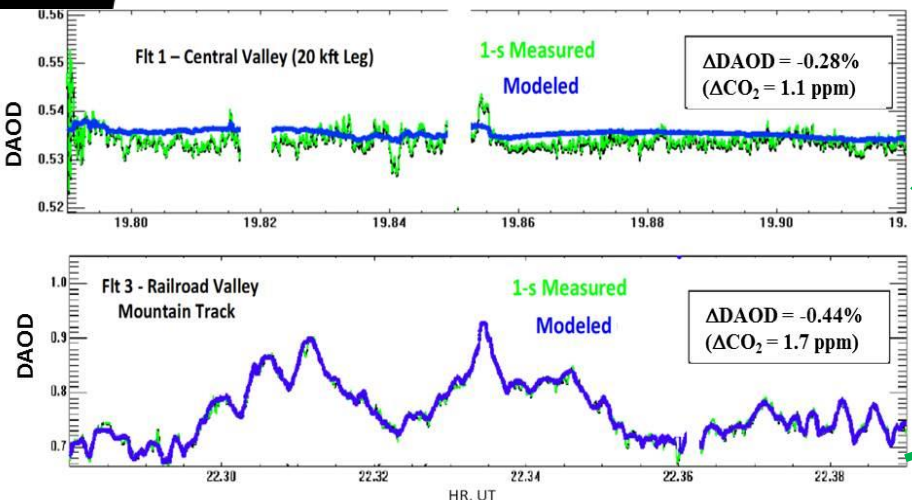

## SNR Comparisons

Flight #	Start Hour	End Hour	Delta Time, sec	Nadir Range, m	Optical Depth	CO <sub>2</sub> , ppmv	1-s SNR	1-s !, ppmv	10-s SNR	10-s !, ppmv
1	20.07	20.08	198.0	6406	0.708	389.7	433	0.90	1264	0.31
3	20.03	20.06	211.0	6593	0.755	394.5	517	0.76	1510	0.26
4	15.63	15.70	396.0	6360	0.704	387.1	460	0.84	1325	0.29
5	20.00	20.02	180.0	8063	0.924	391.8	418	0.94	1274	0.31
7	17.21	17.23	79.2	5805	0.632	379.2	396	0.96	1237	0.31

Avg:	6645	0.745	388.5	445	0.88	1322	0.29
------	------	-------	-------	-----	------	------	------

Modeled DAOD: in-situ XCO<sub>2</sub> measurements + radiative transfer model to calculate CO<sub>2</sub> absorption optical depth



# MFL CO<sub>2</sub> Column Measurements Through Thin Cirrus (22 Feb 2013)



CO<sub>2</sub> concentration (22-Feb-2013)

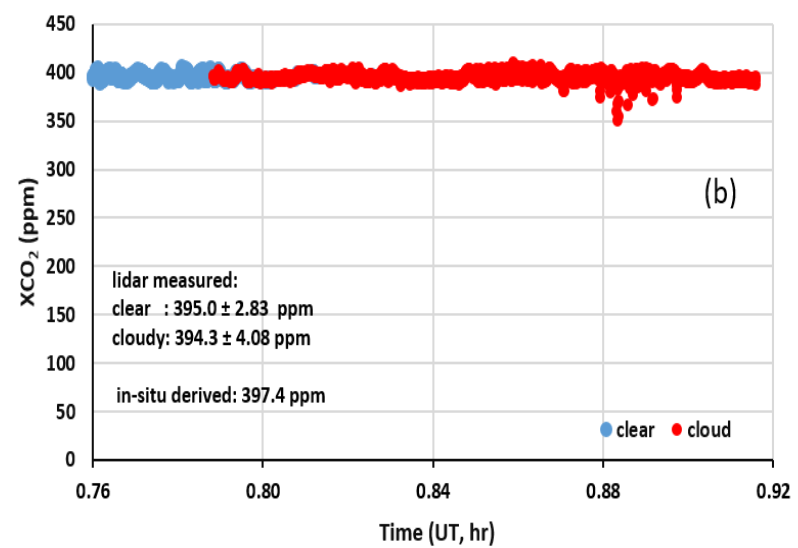
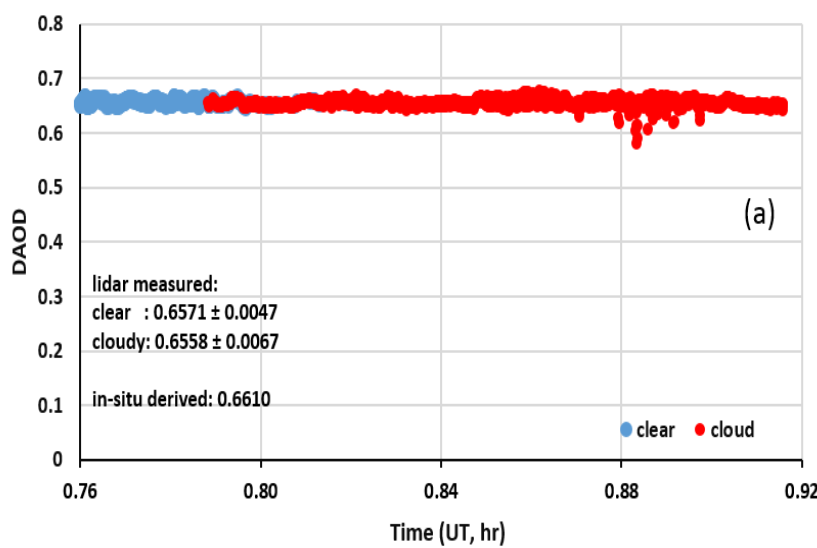
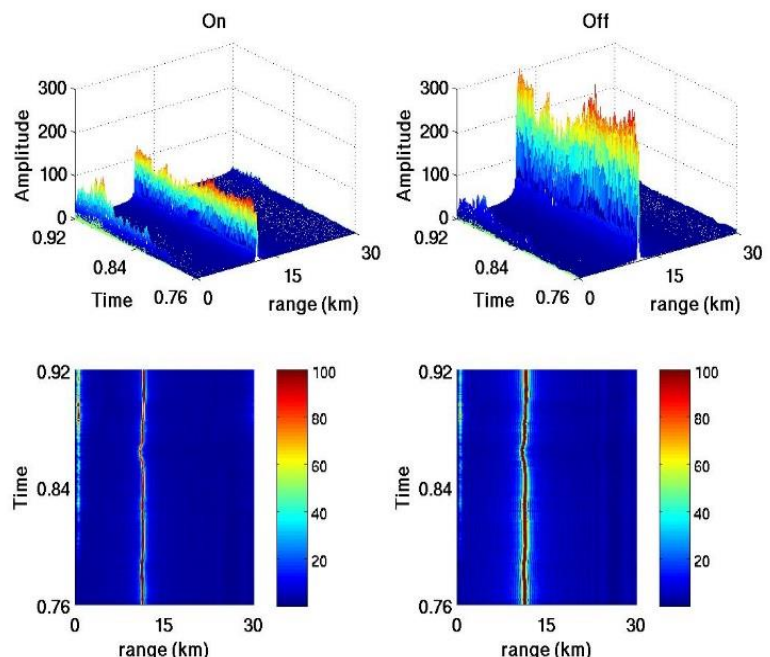
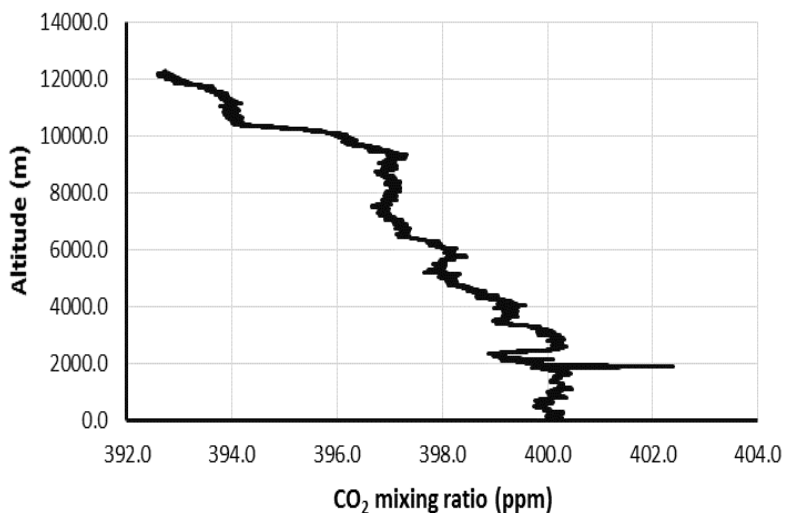



# Comparison of Range Determination from PN Altimeter and Off-line CO<sub>2</sub> Signal

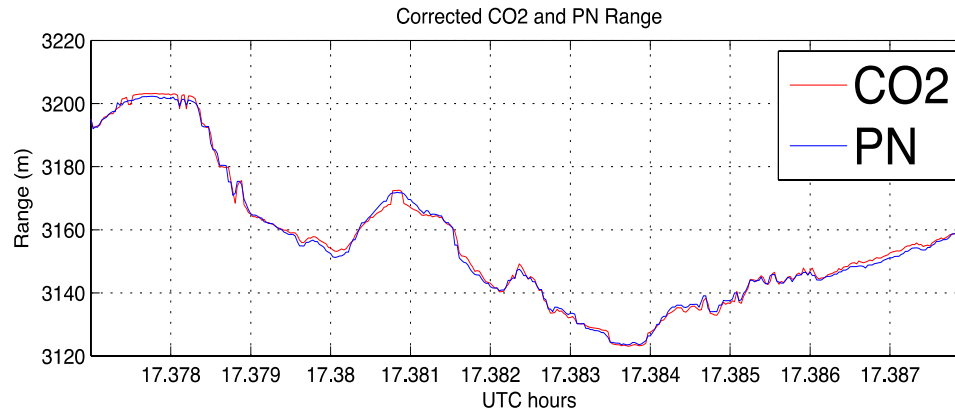

**MFLL**

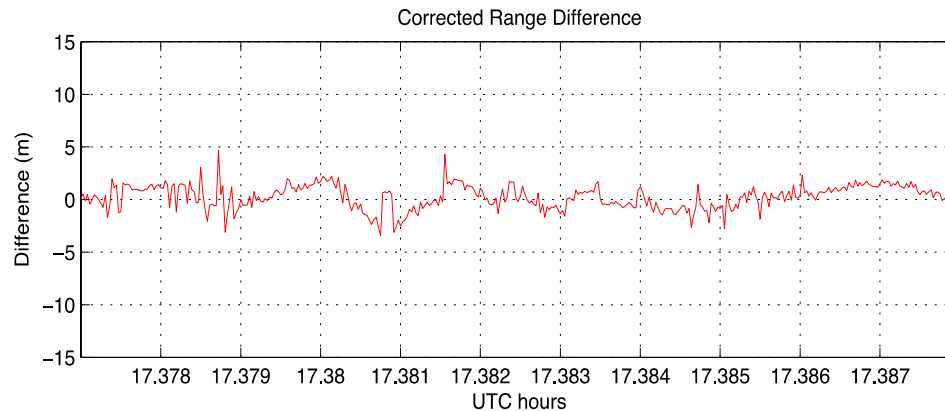

**RMS errors < 3 m**

Range estimates obtained from the off-line CO<sub>2</sub> return and time coincident returns from the onboard PN altimeter over the region of Four Corners, NM from the DC-8 flight on 7 August 2011.





# Ranging over Hampton Roads (ACES in June 2014)



## Chesapeake Bay Bridge

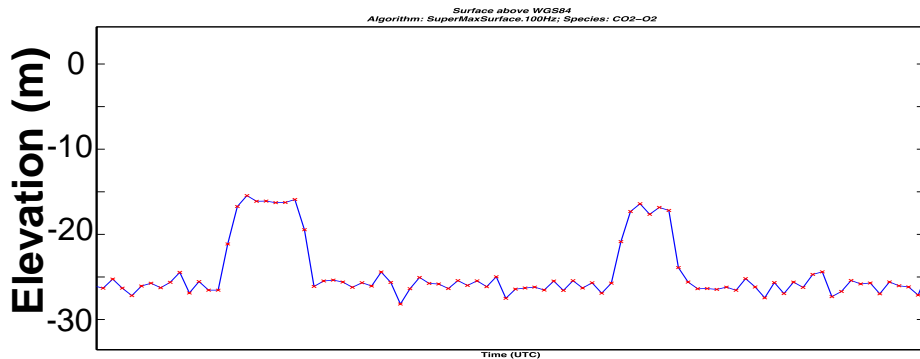



# ASCENDS Mission Development

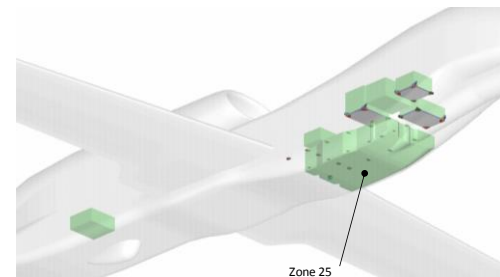
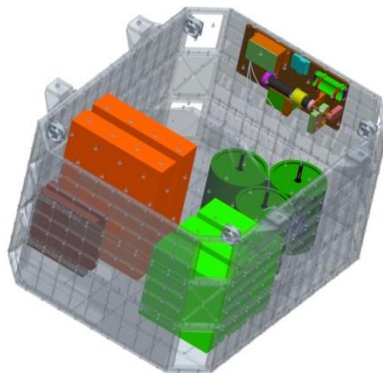

**Today: MFL and ACES instruments in DC-8 racks**

Size = 100" x 43" x 24"  
Mass = 787.2 lb.

Size = 44" x 34" x 24"  
Mass = 317.1 lb

**Global Hawk**



**TBD:  
ISS Tech  
Demo?**



**TBD:  
ASCENDS  
mission**



Current

Future



# Space CO<sub>2</sub> Lidar Modeling and Measurement



same instrument architecture: increased power and telescope

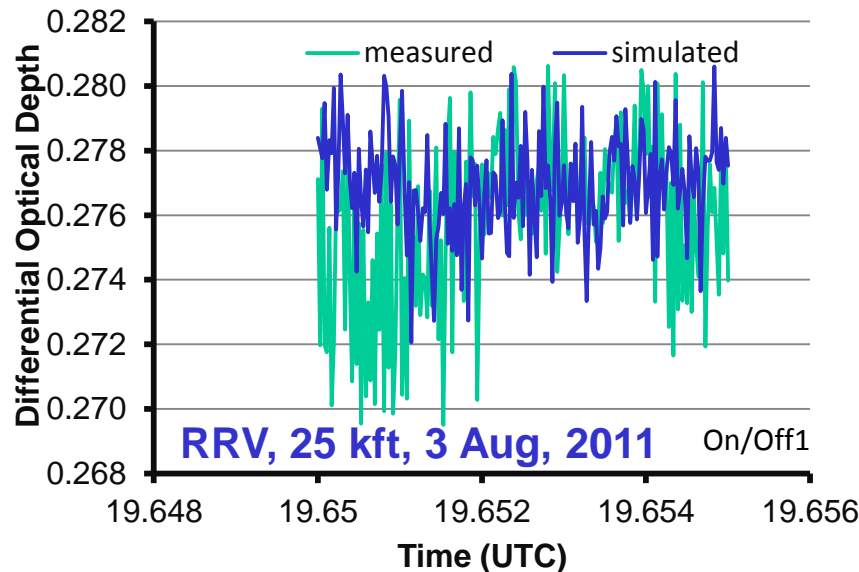
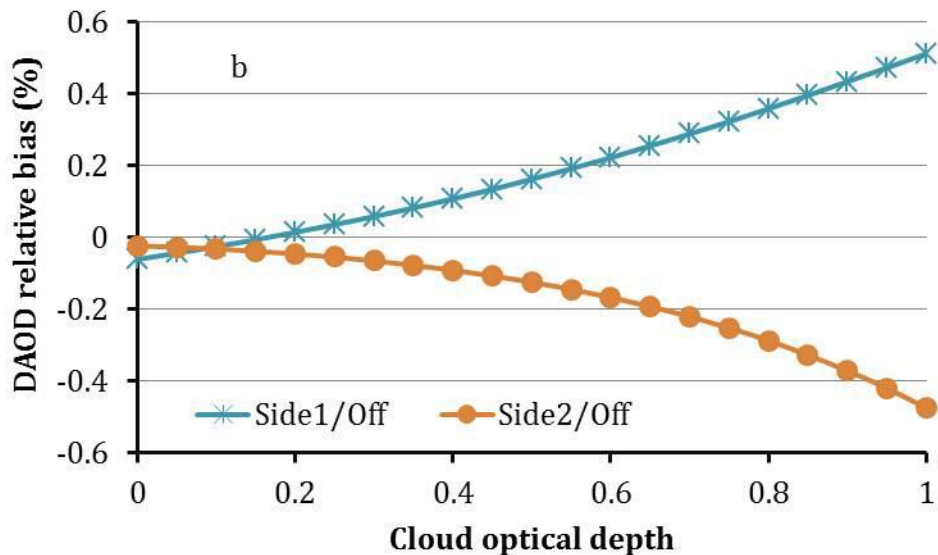
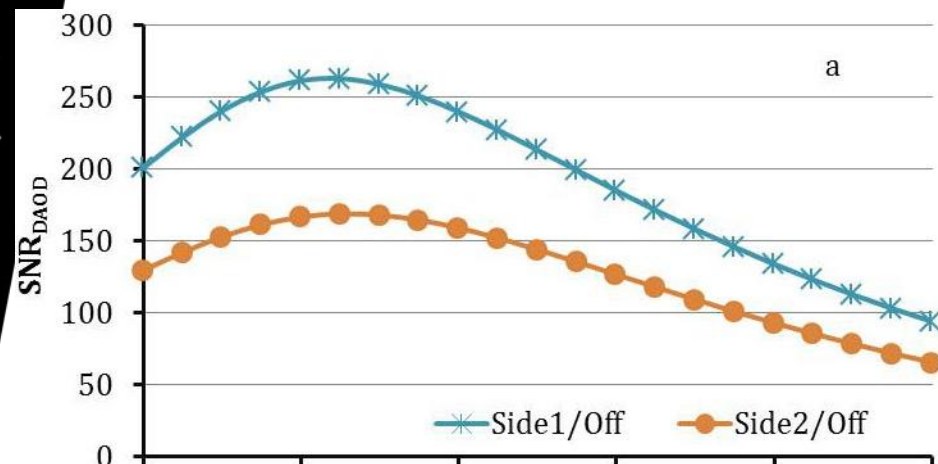

cloud height: 9 km  
0.1-s integration time  
high SNR & small bias (< 0.1%)  
Cloud OD < ~0.4

dawn/dusk orbit, 42W power  
other LEO orbits

# Summary



- ❖ **Global/regional atmospheric CO<sub>2</sub> observations require high accuracy and precision measurements owing to very small variations in atmospheric CO<sub>2</sub> mixing ratio.**
- ❖ **Laser absorption lidar at 1.57 μm with ranging-encoded IM provides advanced capability in cloud/aerosol discriminations.**
- ❖ **IM-CW lidar has demonstrated the capabilities of precise CO<sub>2</sub> measurements through many airborne flight campaigns under variety of environment conditions, including CO<sub>2</sub> column measurements through thin cirrus clouds and to thick clouds. Over land, clear-sky CO<sub>2</sub> measurement precision within 1-s integration is within 1 ppm while mean bias is much smaller.**
- ❖ **Ranging uncertainties are shown to be below sub-meter level.**
- ❖ **Analysis shows that current IM-CW lidar approach will meet space CO<sub>2</sub> observation requirements and provide precise CO<sub>2</sub> measurements for carbon transport, sink and source studies.**



# Atmospheric Carbon & Transport (ACT) – America

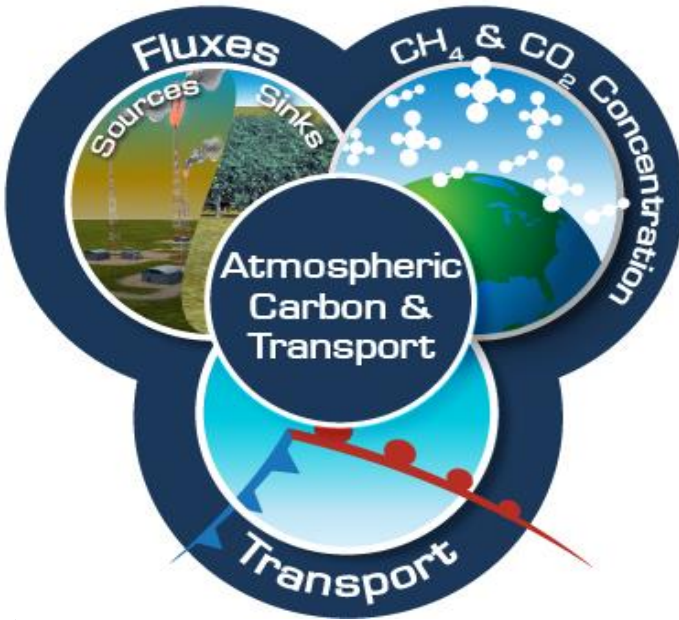

The ACT-America suborbital mission addresses the three primary sources of uncertainty in atmospheric inversions: atmospheric transport, sources and sinks of carbon, and atmospheric concentration measurements.

Penn State  
NASA

LaRC, WFF, GSFC, JPL  
Exelis, Colorado State  
NOAA ESRL/U Colorado  
DOE Oak Ridge, U Oklahoma  
Carnegie Inst. Stanford

