

# The Effect of Laser Scan Strategy on Distortion and Residual Stresses of Arches made with Selective Laser Melting

S. D. Bagg<sup>1</sup>, L. M. Sochalski-Kolbus<sup>2,3</sup>, J. Bunn<sup>2</sup>

<sup>1</sup>Metal Joining and Processes, NASA- Marshall Space Flight Center (MSFC)

<sup>2</sup>Chemical and Engineering Materials Division, ORNL

<sup>3</sup>Materials Science and Technology Division, ORNL

Presented by Stacey Bagg at the 2016 ASPE Summer Topical Meeting: Dimensional Accuracy and Surface Finish in Additive Manufacturing on June 29, 2016  
Marriott Raleigh City Center in Raleigh, North Carolina

National Aeronautics and  
Space Administration



*A portion of this research used resources at the High Flux Isotope Reactor, a DOE Office of Science User Facility operated by the Oak Ridge National Laboratory*



**MARSHALL**  
SPACE FLIGHT CENTER

# Outline

- Background
  - NASA Marshall Space Flight Center:
    - Advanced Manufacturing Lab
    - Precision Metrology Lab
  - Oak Ridge National Lab:
    - Neutron Residual Stress Facility
- Introduction to Residual Stresses in Selective Laser Melting
- Summary of Initial Study
- Characterization Methods and Results
  - Selective Laser Melting Build
  - Profilometer Measurements
  - Neutron Diffraction Measurements
- Conclusions & Future Work



# NASA Marshall Space Flight Center (MSFC): Advanced Manufacturing Lab

NASA MSFC is using Additive Manufacturing (AM) technologies for On-Earth Manufacturing and In-Space Manufacturing

On-Earth AM offers:

- Rapid, low cost, small volume production of Space Flight hardware; Low-weight designs; Zero tooling; Material efficiency
- Optimizing high-cost, high-complexity rocket engine components

MSFC's Advanced Manufacturing lab has invested \$10M USD over the last 4 years, tripling lab space and capacity for AM. The lab has four metal printers – an ARCAM EBM, Concept Laser M1, Concept Laser M2 and a Concept Laser XLINE 1000R.

In-Space AM Offers:

- On demand access to replacement parts and tools
- Critical technology for exploration missions

MSFC's investment in in-space manufacturing established the first AM capability on the International Space Station

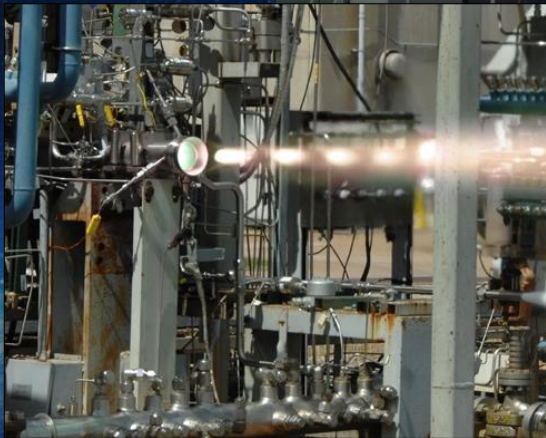

# NASA MSFC: Precision Metrology Lab

Surface metrology & tribology at MSFC M&P lab supported:

- Army Ballistic Missile Agency (c. 1960's)
- Fabrication of the quartz rotors for the Gravity Probe B satellite
- Support of Space Shuttle Main Engine turbo-pump bearings

Metrology lab State-of-the-Art instrumentation includes:

- Stereo microscope (Leica MZ16A with Stereo Explorer Modules)
- Chromatic confocal sensor (CCS) (Solarius LaserScan 200)
- Scanning laser confocal microscopy (Keyence VK-X110)
- Coherence scanning interferometry (Bruker NP-FLEX)
- Skid-less stylus profilometer (Taylor-Hobson Form Talysurf PGI 1230)
- Skidded, portable roughness checker (Hommel T500)
- All in compliance with ANSI/ASME and ISO standards and calibrated to traceable physical standards.

The M&P precision metrology lab has been measuring surface texture of Additive Manufactured parts since 2011

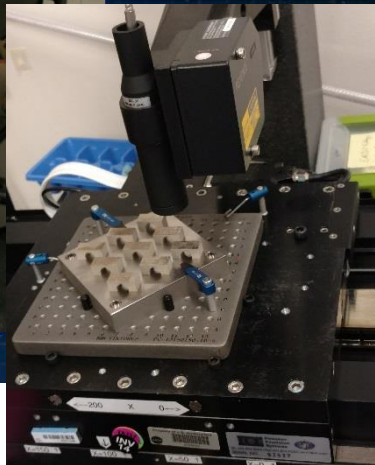

# Oak Ridge National Lab (ORNL): Neutron Residual Stress Facility (NRSF2)



NRSF2 facility maps volumetric residual stresses using high-penetrating neutrons to measure interplanar atomic spacing in materials

- Steel, aluminum, superalloys, other metallic materials
- Inconel 718 in this study

Neutron scattering at ORNL is enabling AM

- Characterize AM materials produced by the ORNL Manufacturing Demonstration Facility (MDF)
- Collaborate with industry partners such as Pratt and Whitney, NASA and Honeywell
- Recent instrument upgrades enable quicker data collection at higher resolution

Other applications include determining residual stresses in welds, forgings, extrusions, bearings, materials under applied stress, thermal treatments or active piezoelectric materials.



# Introduction

Residual stresses in AM components generate distortion in the builds and will effect the functional properties of the material

- Selective Laser Melting (SLM) is an AM solution that builds using ~100  $\mu\text{m}$  welds, leading to highly non-linear heating and cooling, severe thermal gradients, and repeated thermal cycling
- Distortion can cause build interruptions or ruin an entire build plate
- Warping of the final part can keep it from meeting tolerances and specification
- If we understand it, we can predict it. If we predict it, we can mitigate it.

Attempts have been made to use the laser scan strategy to reduce residual stresses and distortions. This study intended to:

- Investigate whether these strategies reduce residual stresses.
- Characterize deformations from each scan pattern



# Initial Study

- An initial study by MSFC at the ORNL NRSF2 found the chess pattern – which was designed to minimize residual stresses – actually resulted in increased residual stresses
- It was thought that the chess pattern minimized distortions, due to operator experience and previous work by Dr. Kruth and Dr. Mercelis, but distortions were not measured in the initial study
- The second study, summarized in this presentation, sought to replicate the original study – providing more data to validate the findings – and investigating the scan pattern's effect on distortions

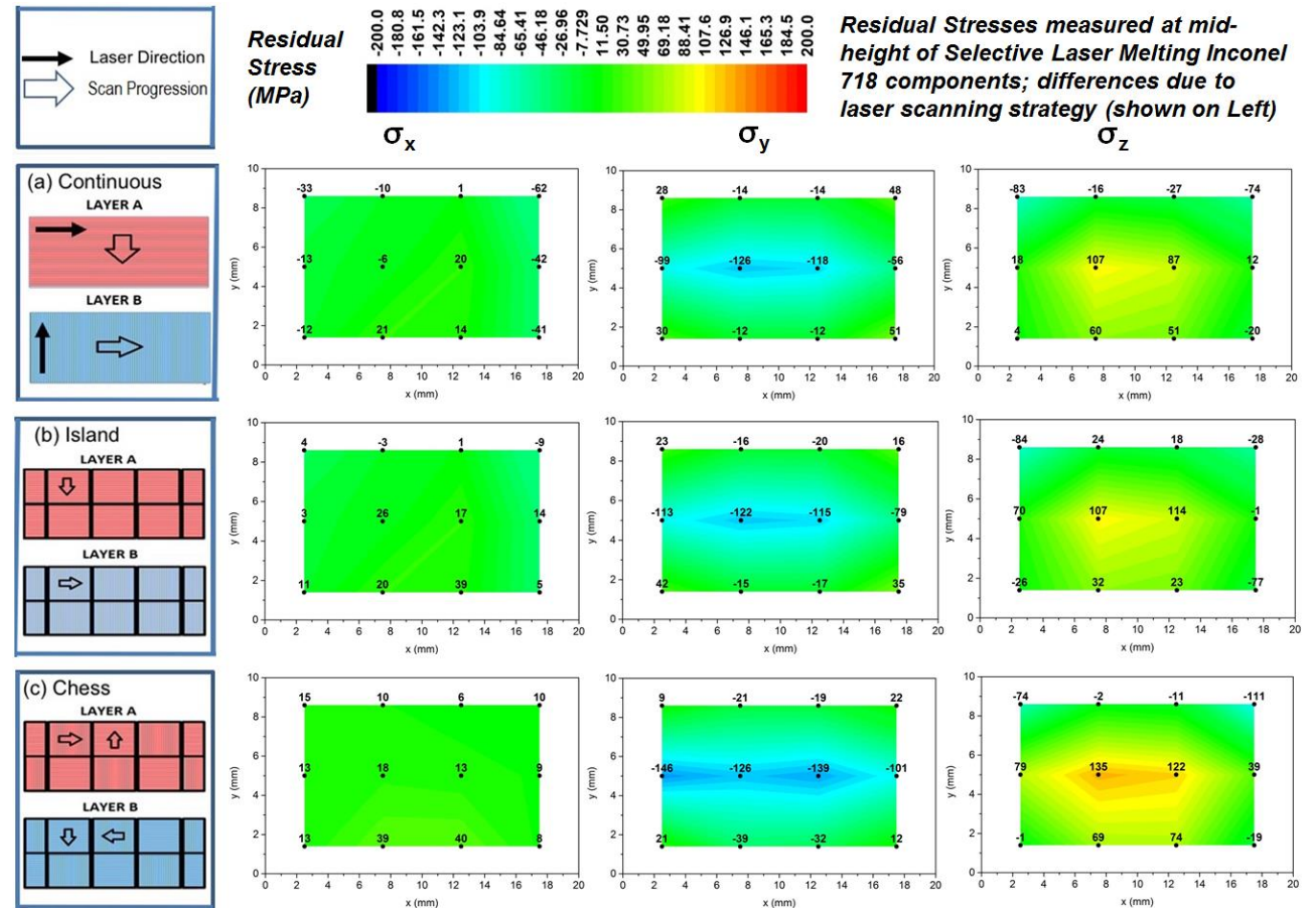

# Component Build

- Sample selected to duplicate geometry used by Dr. Kruth<sup>1</sup> to determine residual stress through distortion of an arch
- Printing Parameters were consistent with parameters used by NASA
- Laser scanning patterns duplicated the patterns used in the first experiment
  - Material: Inconel 718 powder, 10-45  $\mu\text{m}$
  - 0.030 mm layer thickness
  - “A” Continuous, “B” Island, “C” Chess
  - Laser: 180 W, 600 mm/s; Hatch 0.105 mm
  - 5mm square islands, overlap by 0.0225 mm and offset 1 mm in x and y each layer
- 3 duplicates of each sample – to measure one on the build plate, one removed and one stress-free for each condition

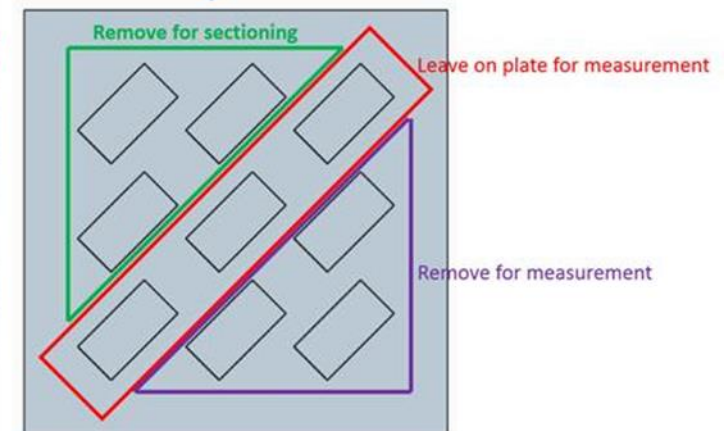
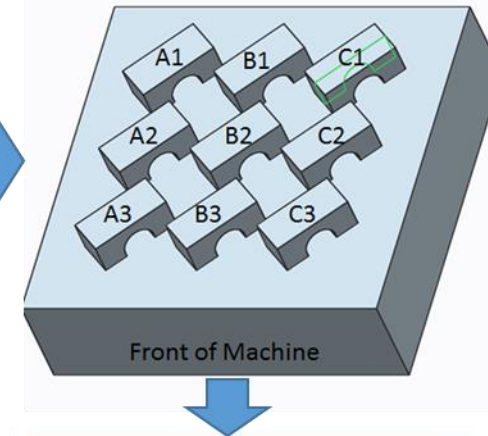
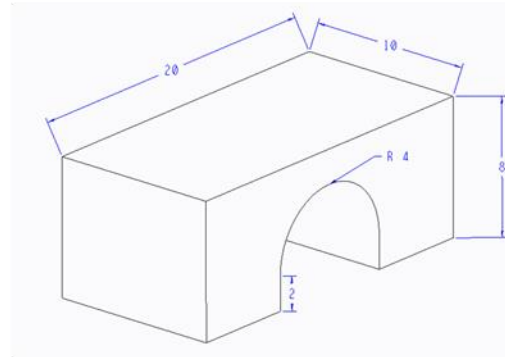

1. J. P. Kruth, M. Badrossamay, E. Yasa, J. Deckers, L. Thijs, J. Van Humbeeck, *Part and material properties in selective laser melting of metals*. 16th International Symposium on Electromachining, 2010.



# Component Build: Video

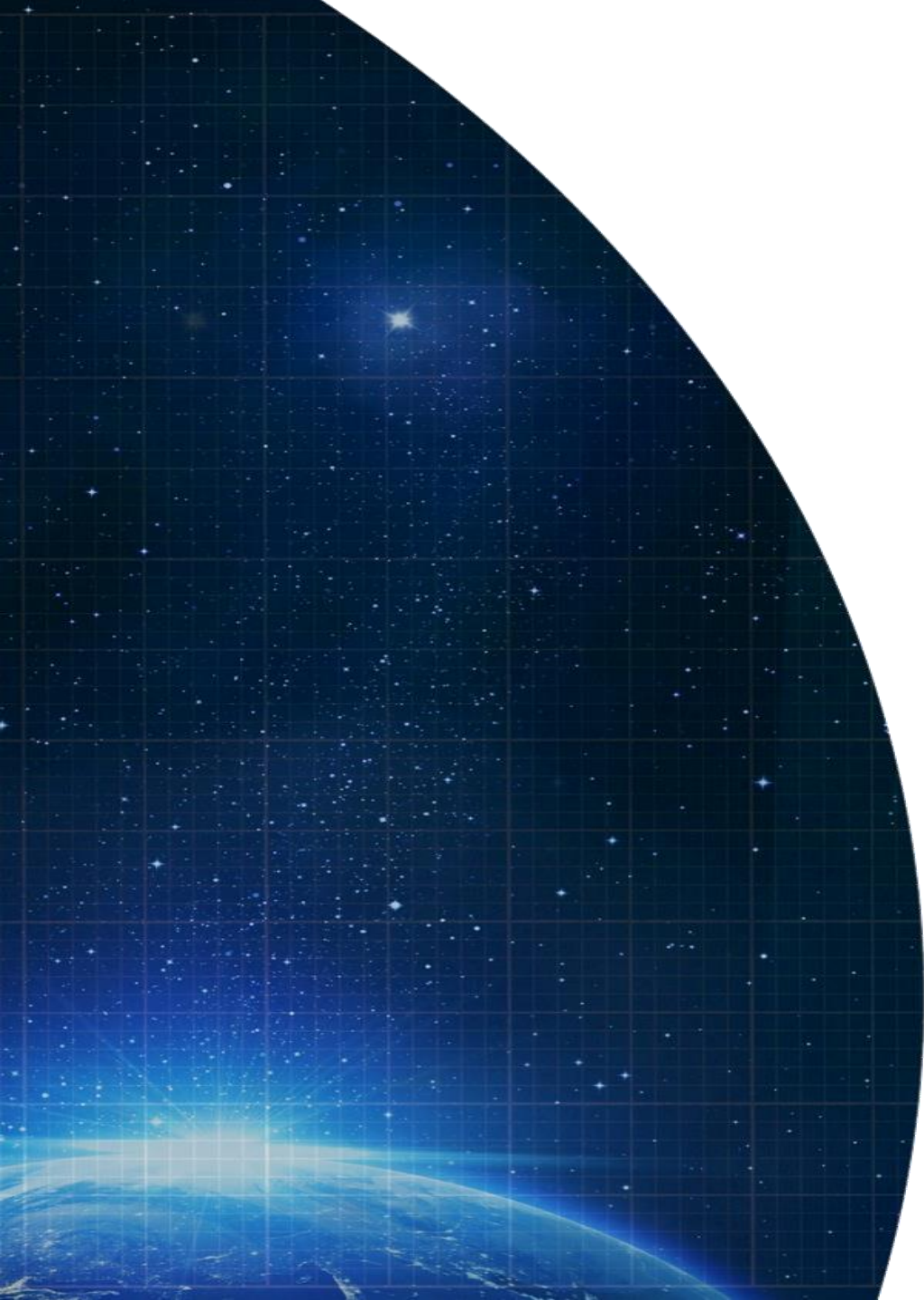
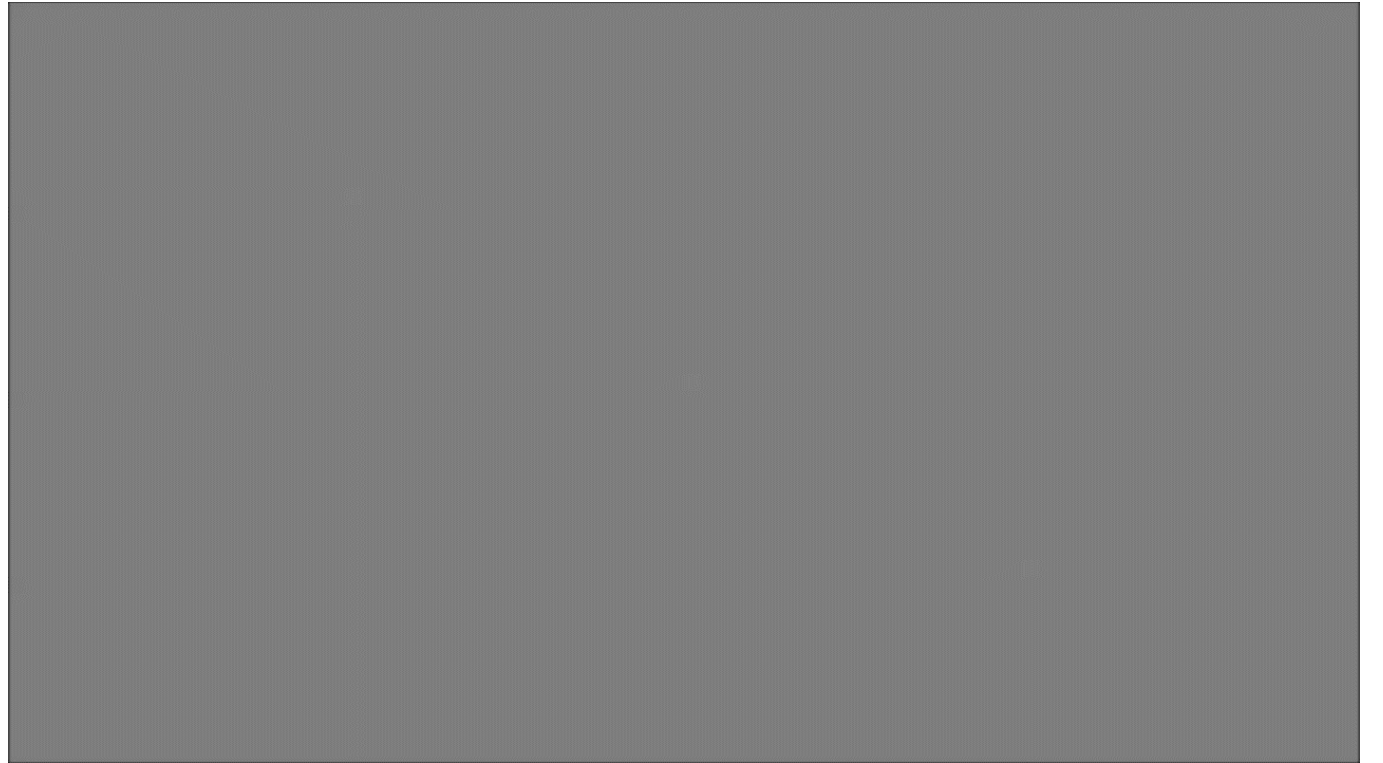

# Profilometer Measurements

- Measurements taken with Chromatic Confocal Sensor Profilometer

- Solarius Development Corporation LaserScan 200mm
  - 2.5 mm range, 75 nm resolution white light chromatic confocal sensor (CCS)
  - Stil CCS Prima + WCL4 optical pen
  - 200 mm XY air bearing stage
- Data analyzed and viewed through SolarMap 3D Topographic analysis software by Digital Surf

- Measurements taken while the samples were attached to the build plate, and repeated after samples were cut from the build plate

- Steps for analysis:

- Zoom to sample surface only
- Level by least square plane (all surfaces)
- Threshold to remove outlier data points
- Line profile analyzed at centerline, including form determination and removal

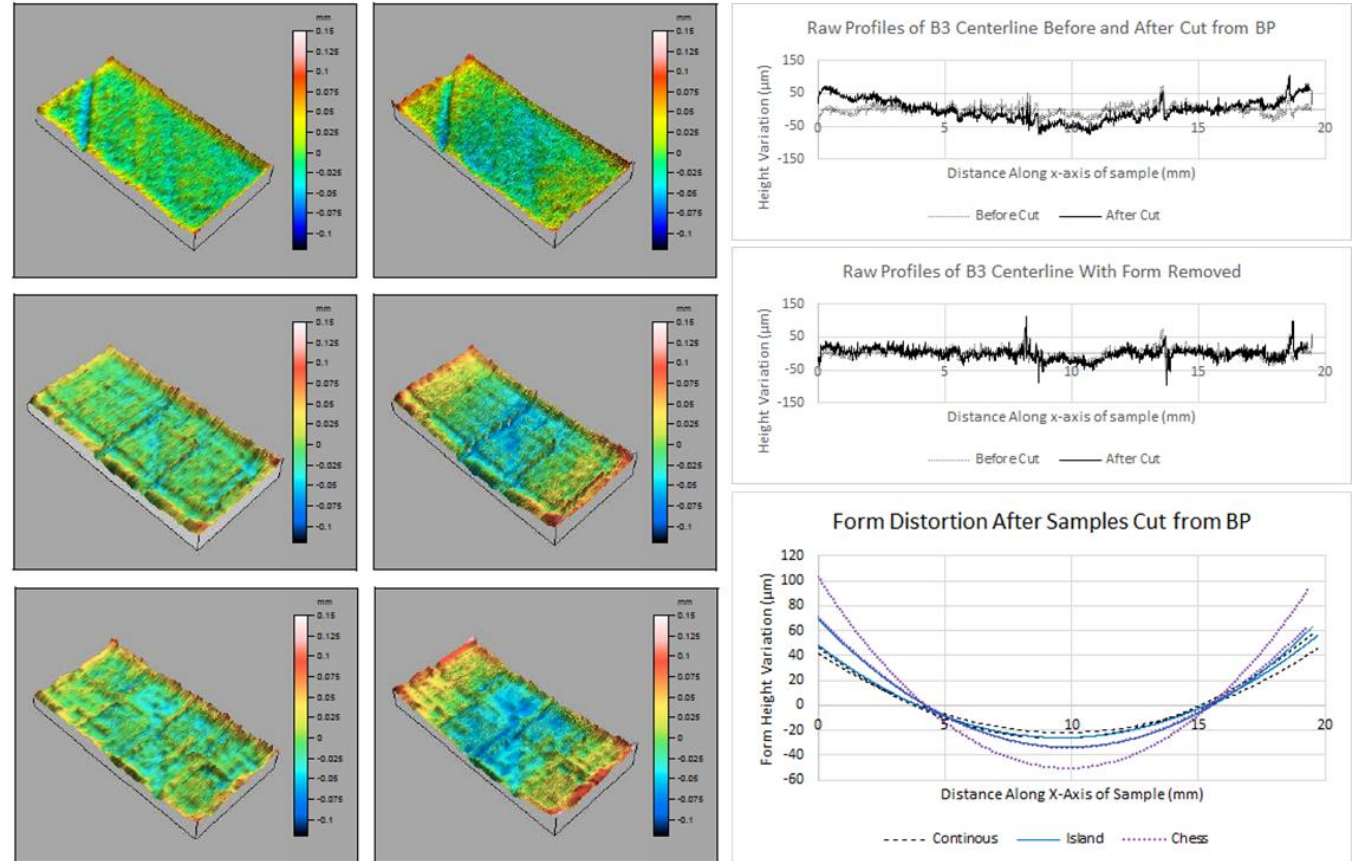

# Volumetric Residual Stress Measurements

- Measurements taken with Neutron diffraction at the ORNL High Flux Isotope Reactor (HFIR)

- Lattice spacing ( $d_{hkl}$ ) measured at NRSF2 in the x, y and z planes - locations shown - using a gauge volume of 2 mm<sup>3</sup>
- Lattice spacing on one sectioned sample was measured for a stress-free reference

- Strain calculation:  $\epsilon_{hkl} = \frac{d_{hkl} - d_{hkl}^0}{d_{hkl}^0}$

- Stress calculations:

$$\sigma_{xx} = \frac{E}{(1+\nu)(1-2\nu)} [\epsilon_{xx}(1-\nu) + \nu(\epsilon_{yy} + \epsilon_{zz})]$$

$$\sigma_{yy} = \frac{E}{(1+\nu)(1-2\nu)} [\epsilon_{yy}(1-\nu) + \nu(\epsilon_{xx} + \epsilon_{zz})]$$

$$\sigma_{zz} = \frac{E}{(1+\nu)(1-2\nu)} [\epsilon_{zz}(1-\nu) + \nu(\epsilon_{xx} + \epsilon_{yy})]$$

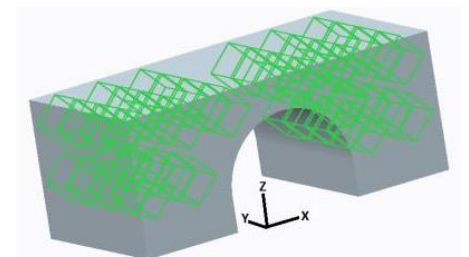
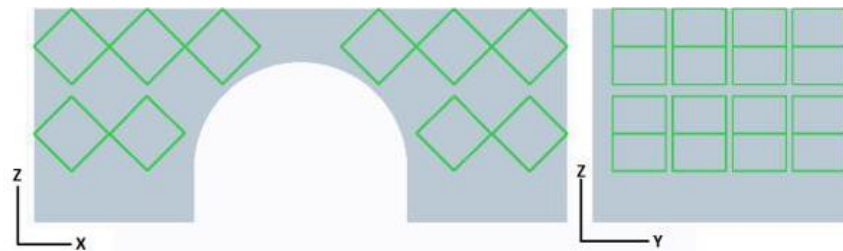
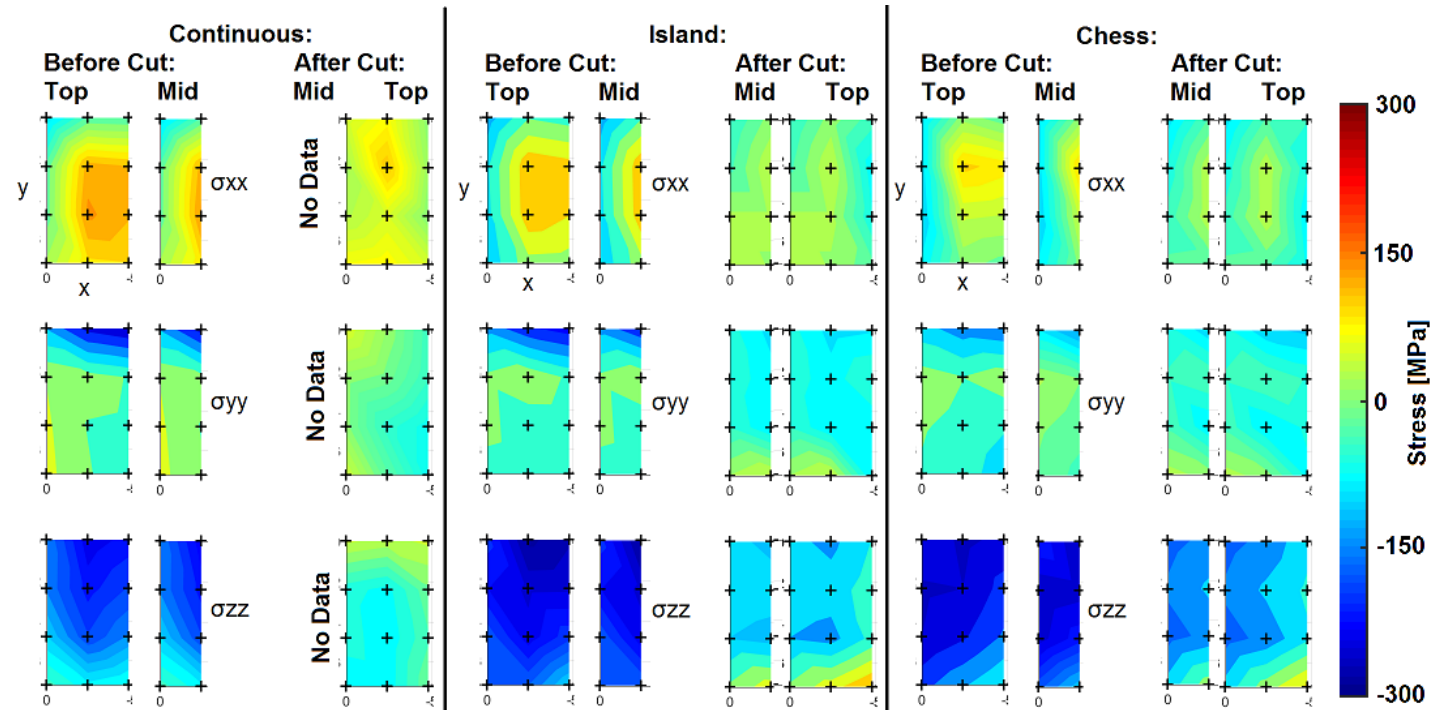

# Conclusions and Future Work

- Highest distortion (due to removal from the build plate and relieving residual stresses) is in the chess sample,
  - Surface profilometry and line scan showed this
  - Not expected and inconsistent with previous work –investigate further.
- Tensile residual stresses in the x-direction were highest in the continuous sample, followed by island and chess
- Compressive residual stresses in the z-direction were highest in the chess sample, followed by island then continuous.
  - May be due to the binding nature of the segments
- A similar shape but larger sample would be desirable to evaluate
  - the small size of the samples made volumetric measurement using neutron diffraction challenging
  - Gage volume of 2 mm<sup>3</sup> necessary in order to include enough grains
  - Top of the arch could not be evaluated due to gage volume size
- Follow-on study on build interruptions and their effect is desired
  - Abnormal results from the initial study are likely due to the build interruption, since results from this study align closer with other residual stress research

The NASA logo is positioned on the left side of the slide, overlaid on a dark blue background with a grid pattern and a view of Earth from space. The logo consists of a blue circle containing the word "NASA" in white, bold, sans-serif capital letters. A red swoosh curves across the circle, and a white orbital path is visible. The background of the slide features a grid of white lines and a view of Earth's horizon from space, with a blue and white atmosphere and a dark blue sky filled with stars.

NASA