

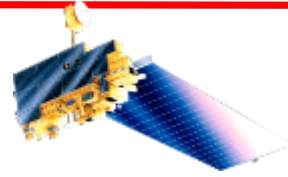

# SPIE Conference



## **Terra Mission Operations: Launch to the present (and beyond)**

Session 5: Earth Observing System (EOS) Terra I

Reference: SPIE Paper Number: 9218-21

**Presenter: Dr. Kurt Thome**

**August 19, 2014**

Prepared by: Angelita Kelly, Eric Moyer, Dimitrios Mantziaras, Warren Case



# Agenda



- **Abstract**
- **Introduction**
- **Spacecraft Subsystem Performance**
- **Spacecraft-Unique Subsystem Component Design**
- **Challenges**
- **Mission Operations**
- **Future Plans**



# Abstract



- Terra satellite is the flagship of NASA's Earth Observing System (EOS)
- Evolution of Terra Operations, including challenges and successes
- Steps taken to preserve science requirements and prolong spacecraft life
  - 5 year design lifetime with a goal of 6 years
  - Successful operations approaching 15 years ([Doing something right](#))
- Review Terra Spacecraft mission successes and unique spacecraft components that allowed for extended mission life and science
  - Special Activities
  - Anomaly Recovery Efforts
- Future Plans for continued Operations



# Mission Overview



## Terra Features

- **Launch Date:** December 18, 1999 (*Atlas IIAS, VAFB*)
- **Orbit:** 705 km, sun-synchronous polar, 98.2° Inclination, 10:30 AM MLT descending node
- **Instrument Payload:**
  - **ASTER (SWIR, TIR & VNIR)** - Advanced Spaceborne Thermal Emission and Reflection Radiometer (Japan)
  - **CERES (Fore & Aft)** - Clouds and the Earth's Radiant Energy System (USA – Langley)
  - **MISR** - Multi-angle Imaging Spectro-Radiometer (USA – JPL)
  - **MODIS** - Moderate Resolution Imaging Spectro-radiometer (USA – GSFC)
  - **MOPITT** - Measurement of Pollution in the Troposphere (Canada)
- **Project Management:** Earth Science Mission Operations (ESMO)
- **Spacecraft Flight Operations:** Contracted by GSFC to Honeywell/ASRC/GATS/AIMM team and supported by NASA NENs and TDRSS
- **Instrument Operations and Science Data processing:** Performed at respective Instrument Locations where developed
- **Mission Duration:** Successfully completed Prime mission of 5 years. Currently in Extended Operation.
- **Distributed Active Archive Centers:** LP DAAC – MODIS, ASTER; Langley DAAC – CERES, MISR, MOPITT



ASTER

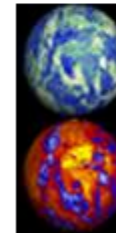

CERES



Terra (EOS AM-1)



MODIS



MISR

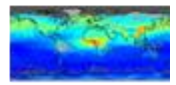

MOPITT

## Science

- *The primary objective of the Terra Mission is to simultaneously study clouds, water vapor, aerosol, trace gases, land surface and oceanic properties, as well as the interaction between them and their effect on the Earth's energy budget and climate.*

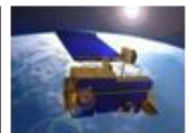



# Terra Video

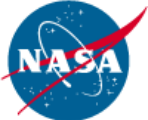



# Spacecraft Subsystem Performance



- Terra's Subsystems continue to perform well on primary hardware
- Propellant remains the life limiting item
  - Maintaining orbit has required 122 propulsive maneuvers since insertion into mission orbit. The types of maneuvers include:
    - Drag Make-up (DMU) maneuvers to compensate for effects of atmospheric drag
    - Inclination Adjust Maneuvers (IAMs) to maintain the proper sun-synchronous precession rate
  - Terra has sufficient propellant to continue nominal operations at the 705 km orbit height through January 2020 and reserve sufficient fuel to meet 705km Constellation Exit Requirements (2km below Constellation orbit)
- Battery Capacity is closely monitored – significant power margin exists
- Battery Temperature is closely monitored
  - Hex Bay Battery lost Heater Control (4/9) of the battery due to Micrometeoroid or Orbital Debris (MMOD)
  - Power Module Battery continues to operate nominally
- Solar Array Performance – Significant Power Margin even with 1/24<sup>th</sup> of capability lost in 2000



# Spacecraft Subsystem Performance Fuel Usage

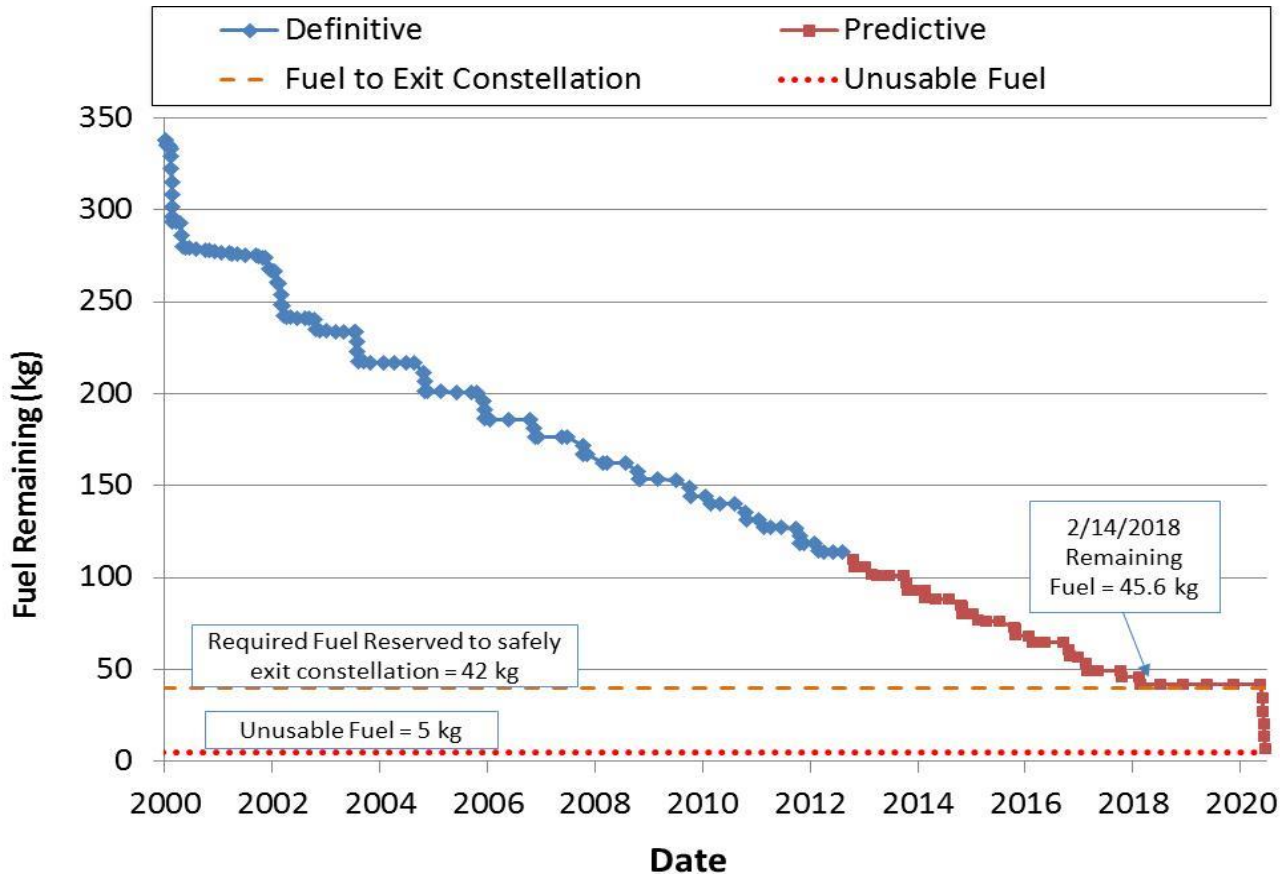

**Terra has sufficient propellant to continue nominal operations at the 705 km orbit height through January 2020 and reserve sufficient fuel to meet 705km Constellation Exit Requirements (2km below Constellation orbit)**



# SA Power Prediction

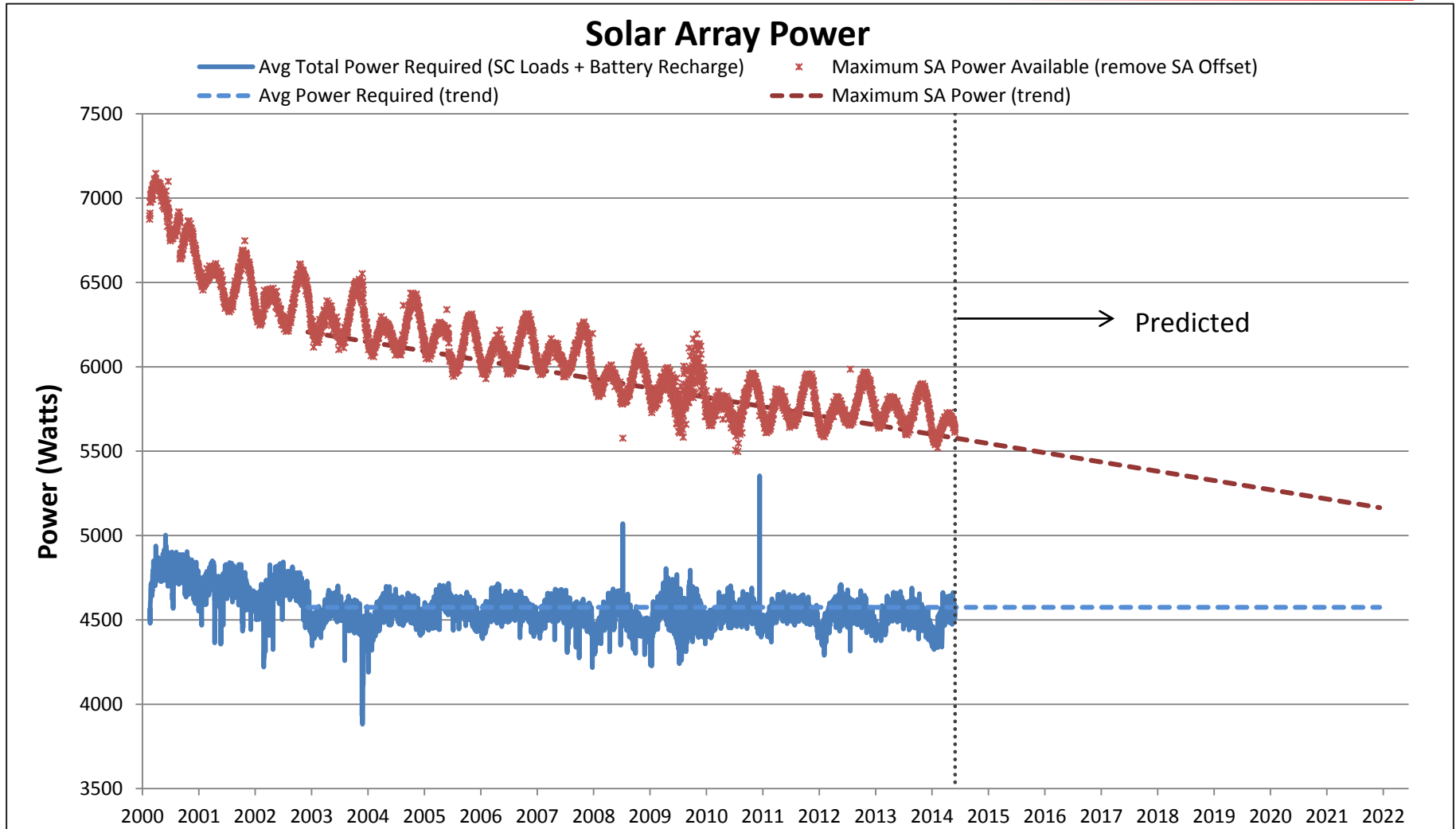

- Avg. Total Power Required is the power needed to support SC loads and battery charging
- **Assuming the current rate of SA power degradation, and assuming the same load required, Terra's SA should be able to support the power requirements through 2022+**





# Spacecraft-Unique Subsystem Component Design



- MODIS Direct Broadcast – Build it and they will come
  - Terra’s MODIS DB data has proven to be extremely popular and beneficial for operational use throughout the world for weather forecasting, fire management and monitoring, disaster management and monitoring, fishery, military application, etc.
  - Over 200 identified ground stations that receive and process Terra DB data
  - Processed data are distributed further to various government and private institutions and users
- Solar Array Blanket
  - Lightweight design:  $\sim 1/3$  mass compared with traditional solar arrays of similar size
  - Reduction in weight allowed for better alignment of translation thrusters through center of spacecraft mass minimizing the complexity of yawing the spacecraft to perform nominal drag make up maneuvers



# Spacecraft-Unique Subsystem Component Design



- Regulated 120V Bus controlled by Power Distribution Unit (PDU)
  - First orbiting 120V regulated bus by NASA
  - Reason for selecting 120V Bus:
    - Handle the high power demands for the spacecraft bus and instruments
    - Reduce the spacecraft mass
    - Reduce parasitic losses
    - Reduce bus noise
  - PDU regulates the spacecraft bus power by providing control signals to the Solar Array (SA) Sequential Shunt Unit (SSU) and the Battery Power Conditioner (BPC)
- Battery Cell Bypass Protection added after initial design to all 108 cells
  - prevents a cell failing “open” to cause loss of all 54 cells within a battery
  - Some experts considered this an unlikely scenario
    - Cell failure during MMOD event resulted in open cell.
    - Bypass protection allowed operations to continue without interrupting science
- Battery Power Conditioner (BPC)
  - Performs both Charge and Discharge Functions to/from the batteries



# Spacecraft-Unique Subsystem Component Design

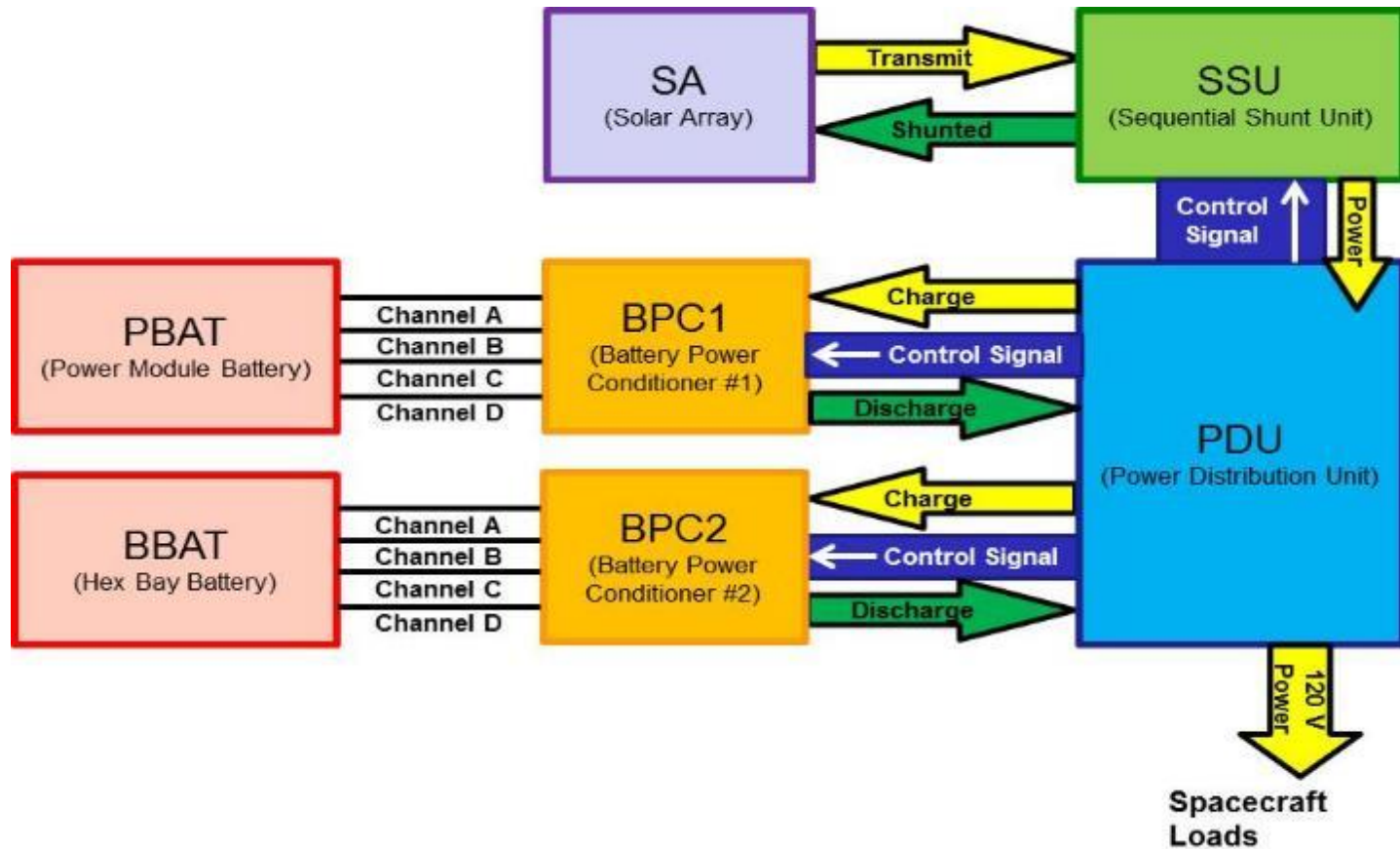

Power subsystem was designed to operate batteries independently yet have the batteries share the spacecraft load.



# Terra Challenges and Anomalies

---



The following charts show examples of challenges and anomalies encountered by the mission operations team at GSFC and how they have been resolved/accommodated while keeping Terra operations nominal.



# Terra Challenges

## Conjunction Assessment



- Prior to adding processes to monitor for conjunctions with orbital debris and active satellites, the FOT was focused on maintaining spacecraft Health & Safety, maintaining orbit, performing calibration activities, and ensuring the downlink of science data
- Conjunction Assessment became a new high priority to protect Terra and other satellites, and to preserve popular orbits from additional debris
  - The conjunction assessment process not only evaluates the conjunction of two objects, it also evaluates post-maneuver conjunctions to provide insight on how safe a planned maneuver is before execution
  - Terra was the first of the 705km International Constellation satellites to perform a Risk Mitigation Maneuver (RMM) on October 21, 2005
- This evolving threat was exacerbated by the Chinese anti-satellite missile test with Fengyun 1C on January 11, 2007 and the Iridium 33/COSMOS 2251 collision on February 10, 2009
- As of July 19, 2014, Terra has conducted 12 Risk Mitigation Maneuvers (RMMs)
  - include either performing a maneuver to mitigate a conjunction or waiving off a maneuver to prevent a post maneuver conjunction
- Another 12 predicted conjunctions required RMM planning but eventually conjunction risk reduced prior to maneuver execution allowing for the RMM to be waived off



# Terra Challenges

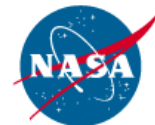

## Battery Anomaly and MMOD Strikes

---

- Micro Meteor Orbital Debris (MMOD) is believed to be the most likely cause of the BBAT cell failure (1 of 54) and loss of heater control for half of BBAT. PBAT remains unaffected
- To compensate for the BBAT lost heater control:
  - BBAT has been configured to perform slight overcharge to maintain cell temperatures above freezing.
  - Recently, the FOT has utilized the BPC to shift additional load to the BBAT and less load to PBAT.
    - This increased BBAT discharge every orbit increased the temperature of the BBAT cold cells by approximately 2 degrees Celsius thereby reducing the risk of BBAT cells reaching freezing temperatures if a spacecraft load reduction were to occur
    - The FOT accomplished this by utilizing the BPC design in a way that was not envisioned during development. After consultation with the spacecraft manufacturer, GSFC battery experts and Flight Software Sustaining Engineering, changes were made to the battery management software to allow for the batteries to be operated independently. Disabling the PBAT BPC Channel increased the BBAT discharge by 14%



# BPC1 Channel Disable to Increase BBAT Temperatures

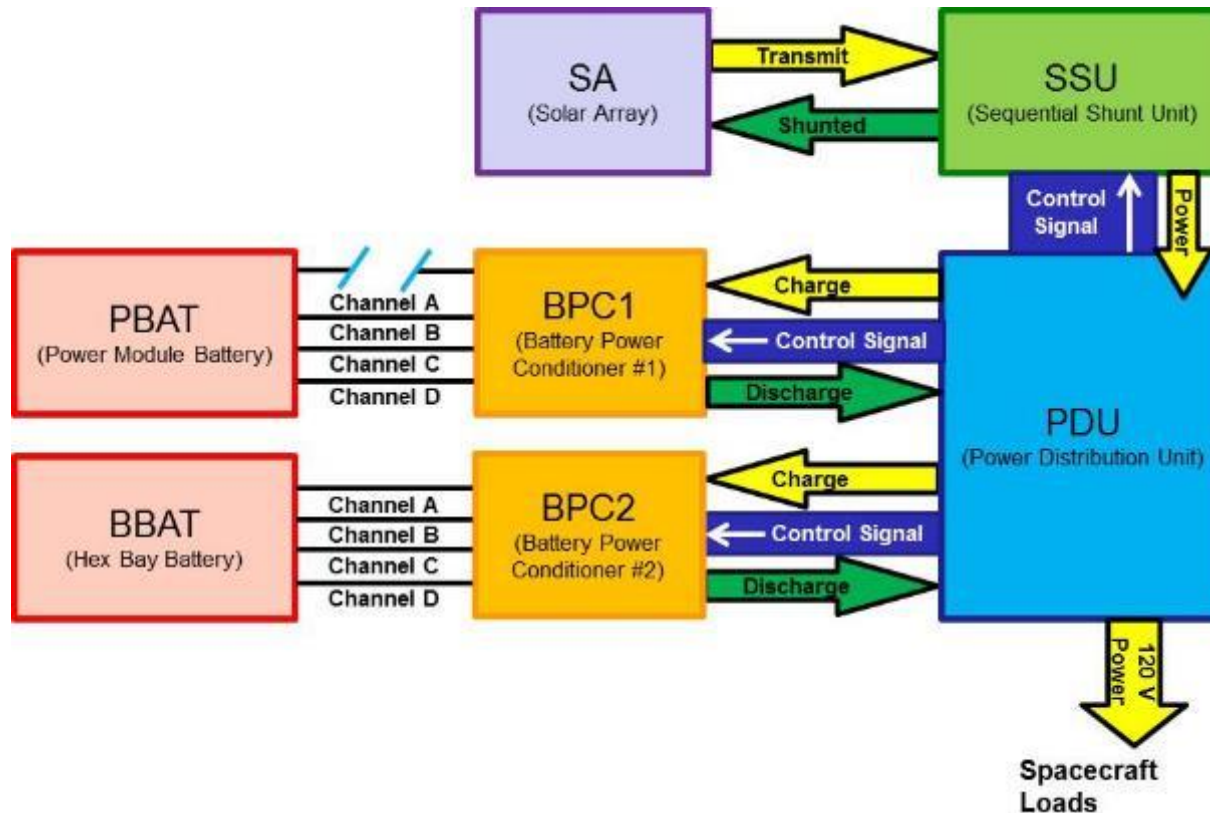

Although not intended to operate the batteries in an unbalanced mode, the design allowed for disabling one BPC1 Channel which reduced discharge on PBAT to 3/7 and increased BBAT to 4/7. The additional load resulted in a 2 degree increase in BBAT cold cell temperatures.



# BPC1 CH Disable Summary



## BBAT 2-day Avg Cell 3-pack

### Temperatures

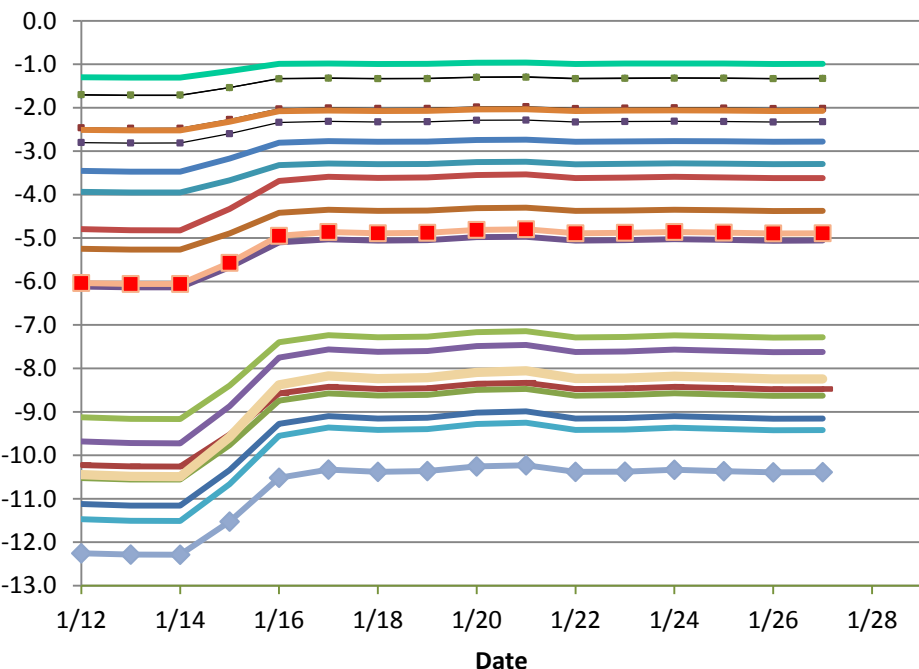

### BBAT

- Approx. 2°C increase on coldest cells
- Approx. 1°C increase on BBAT avg temp
- Decrease in heater Duty Cycle
- Delta decrease from ~10°C to ~8.5°C

## PBAT 2-day Avg Cell 3-pack

### Temperatures

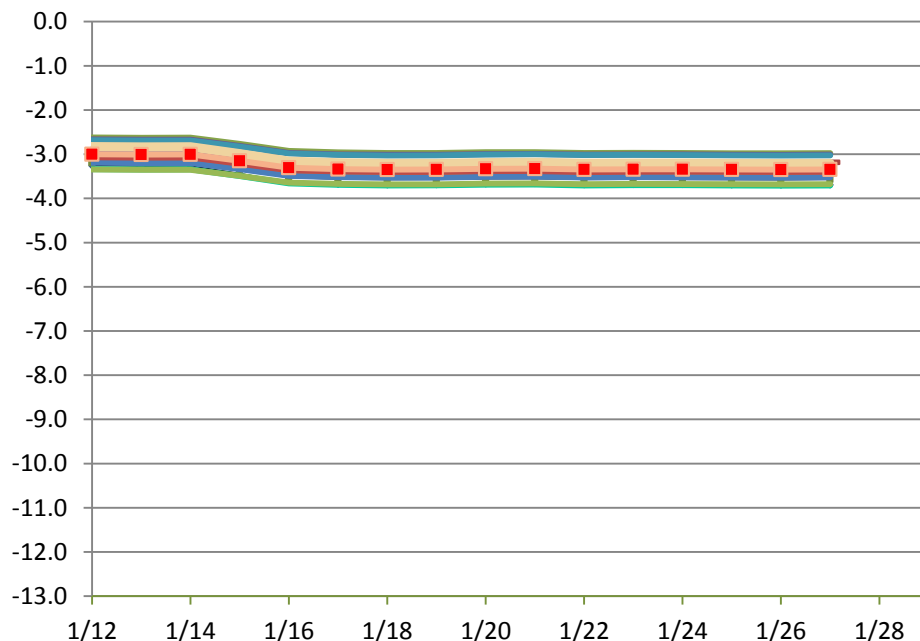

### PBAT

- Approx. 0.3°C decrease on PBAT avg temp
- Still within heater setpoints
- Increase in Heater duty cycle





# Terra Challenges



## Lack of Bit Synch in Fill Blocks

---

- The design of the Communication fill blocks did not include bit synch
- This requires Terra, on each and every support, to play back live science data in order for White Sands (WS) to lock on the data (actual science data blocks contain bit synch)
- However, because this doesn't happen immediately, this initial data must be replayed again once all the data is down, to capture the portion of the data that was missed while WS was locking onto the data stream
- This has increased the complexity of capturing the data, and thus leading to operator errors/data losses and complicating automation of SSR operations



# Terra Challenges

## HGA MDA2BITE Anomaly



- The Motor Drive Assembly (MDA) Built-In Test Equipment (BITE) is designed to protect the MDA. If the motor current is too high (above 1250 mA) or too low (less than 475 mA), the Antenna Control (ACON) automatically turns off the MDA in response and sets a bit to indicate an MDABITE failure
- However, the High Gain Antenna (HGA) Motor Drive Assembly (MDA) Opto-couplers are susceptible to single event upsets, induced by high energy protons usually over the South Atlantic Anomaly or the poles, which causes the protection to trip erroneously
- When the MDA is turned off, the HGA loses proper pointing control and will begin off-pointing from the intended TDRS satellite. This can result in a drop out of the K-Band (High Rate Science) and S-Band (Command/Telemetry) communications links through the HGA until the MDA can be recovered
- This anomaly continues to reoccur, with 2153 recorded MDA2 BITE Failures between 12/19/99 - 6/25/2014 (approximately 12-14 times a month)
- Due to this issue a Telemetry Monitor (TMON) was developed to allow the flight software on board to recycle the MDA by detecting when a MDA2BITE failure occurs and will reset the MDA, recovering within a minute of the first occurrence, minimizing the impact to K-Band and S-Band



# Terra Challenges

## IT Security Threats



- EMOS sustained a significant IT security intrusion in Spring 2006 that had the potential to disrupt commanding to the 3 EOS missions
- Many security enhancements have been implemented since the intrusion which greatly improve the EOS ground system security posture and system reliability
- ESMO has implemented re-hosting and re-engineering the ground system with new hardware, software, and operating systems
- The improvements are designed to be vendor-maintained through 2015 and beyond, reduce security vulnerabilities, and maintain a backup control center capable of performing nominal operations



# Terra Challenges

## Ground System Obsolescence



- Maintaining aging hardware and deploying required security updates to the current ground system is challenging because of the lack of vendor support for the old hardware and operating systems
- Testing and transitioning to the new systems with minimal impact to operations required extensive coordination and re-planning around spacecraft anomalies and critical activities
- The EOS missions accomplished this over the course of several years while maintaining full operations of all three missions
- **Analogy:** Trying to fix a car while it is moving down the highway with everything still performing normally



# Terra Future Plans

## Baseline Constellation Exit Plan

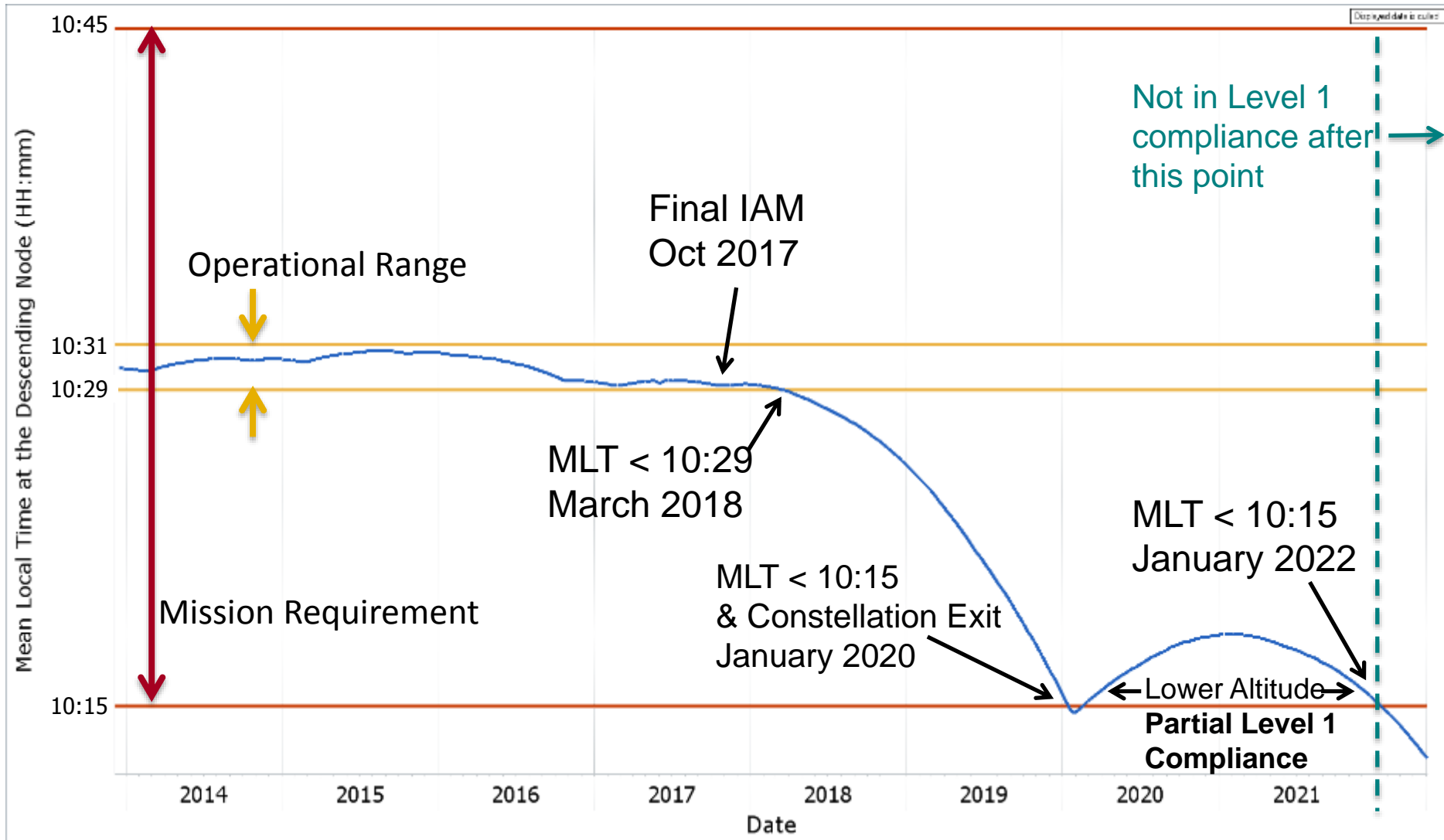



# Terra Future Plans

## Proposed Constellation Exit Plan

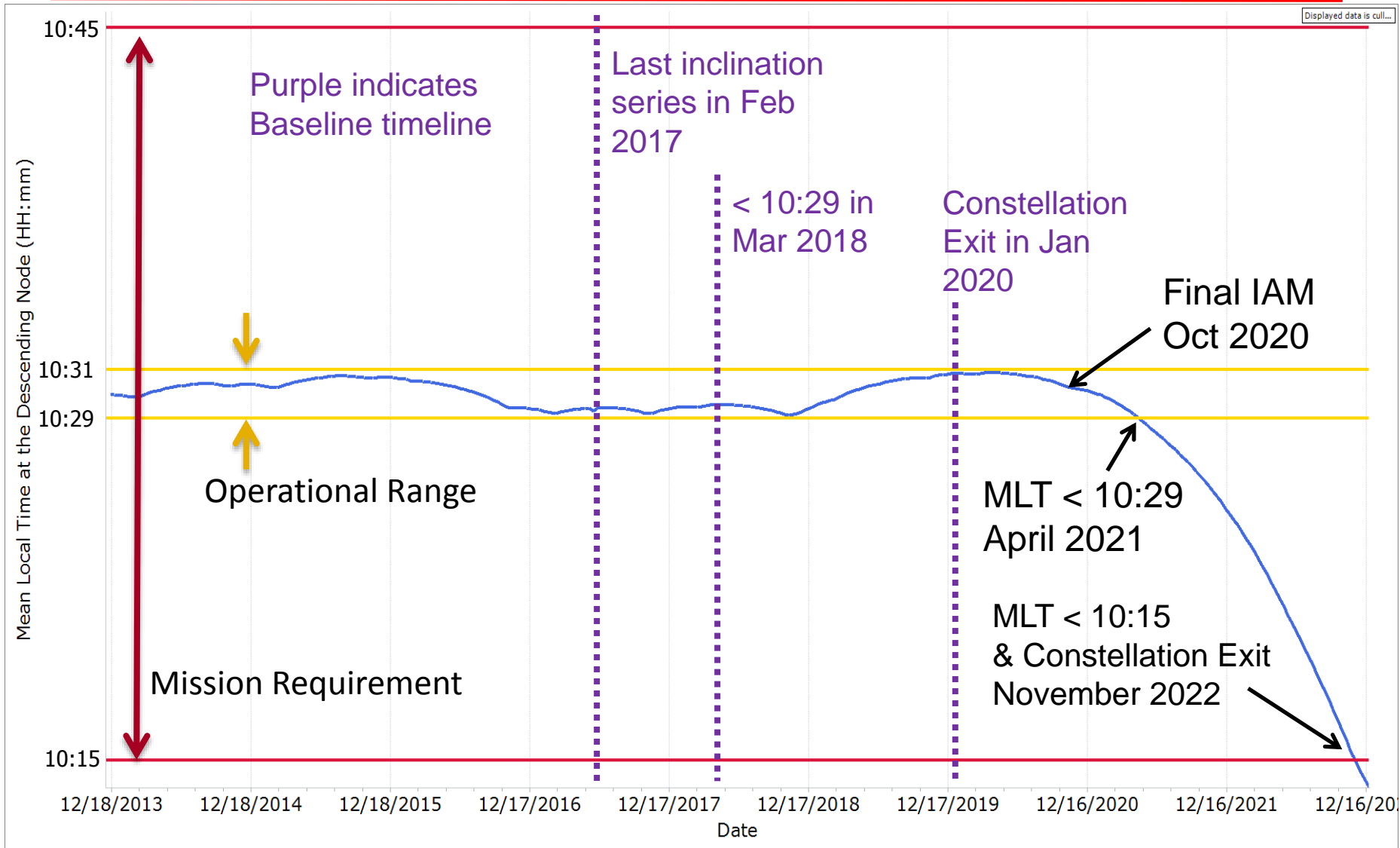

\*After Nov 2022 not Level 1 compliant



# Summary



- Terra continues to perform nominally and provide excellent data for the science community and operational users
  - Still operating on primary spacecraft components except for the Direct Access System (DB) Module (operating on redundant side)
  - All the instruments are producing science data except ASTER-SWIR
  - Anomalies have been successfully resolved/accommodated
- Data Capture/LO Processing Status – GREEN
- Solid State Recorder Data Capture to 06/30/2014: 99.30%
- Data Latency – Excellent (Near realtime data delivered within 2.5 hours)
- Ground Systems – Major System Upgrades completed
- Responding to new security requirements and upgrades to obsolete hardware or COTS systems, as required
- Future Terra Operations
  - **Proposed options for Post-2017 science operations have been developed—needs review by Science Team, Constellation members, and NASA Headquarters**



---

# Backup Charts





# Degraded Components



Subsystem	Component	Design	Current	Capability	Comments
EPS	Solar Array	24 Shunts	23 Shunts	96%	Degradation is minimal. Fully capable of supporting mission through 2022 unless future failures occur
	Batteries	108 Cells	107 Cells	99%	Hex Bay Battery cell #50 failed on 10/15/09, Significant Power Margin. Not an issue.
	Batteries	36 Heater Controls	28 Heater Controls	77%	BBAT heater control failed on 4 of 9 heater groups on primary, redundant, and survival. Battery cell charging/discharging and the remaining heater groups are preventing cells from freezing. Power Module Battery heater control performance is nominal
COMM	X-Band	2	1	75%	Direct Access System Modulator Side 1 failed (50%). Solid State Power Amplifier redundancy still available (100%). X-Band no required to meet mission requirements
CDH	SSR	59 PWA	50 PWA	84.70%	Recycle of Data Memory Unit likely to recover all Printed Wire Assemblies (PWA)
Instruments	ASTER - SWIR	2	2	Failed	Cooler is unable to maintain detector temperature. Science Data is unusable (Fully Saturated) and is no longer being recorded. Still collecting and monitoring Engineering data.
	MODIS	2	1	50%	Power Supply #2 failed, Formatter A degraded, cross-strapped. Science is nominal.
	MOPITT	2	1	50%	Displacer B and Chopper Motor failed. Only 47% of science is valid.

**All other Spacecraft components have full redundancy.**



# Life Limiting Components



Subsystem	Component	Design	Current	Capability	Comments
EPS	Solar Array	24 Shunts	23 Shunts	96%	Degradation is minimal. Fully capable of supporting mission through 2020 unless future failures occur.
	Batteries	108 Cells	107 Cells	99%	BBAT cell #50 failed on 10/15/09.
	Batteries	36 Heater Controls	28 Heater Controls	77%	BBAT heater control failed on 4 of 9 heater groups on primary, redundant, and survival. Battery cell charging/discharging and the remaining heater groups are preventing cells from freezing. PBAT heater control performance is nominal.
TCS	MOPITTCPHTS	2	2	Full	Performance is nominal
	SWIR CPHTS	2	2	Full	Performance is nominal
	TIR CPHTS	2	2	Full	Random temperature fluctuations. Performance within requirements.
SCC	SCC	2	2	Full	Performance is nominal
COMM	HGA	2	2	Full	MDA BITE failures occur 2-3/week due to SEU. Recoverable
	X-Band	2	1	75%	DAS Modulator 1 failed (50%). Solid State Power Amplifier redundancy still available (100%).
	CTIU	2	2	Full	Performance is nominal
	OMNI	2	2	Full	Performance is nominal
CDH	MO	2	2	Full	Drift rate changes have occurred since 10/3/10. Performance is within requirements.
	SFE	2	2	Full	SFE SEU occur 1-2/year. Recoverable
	SSR	59 PWA	50 PWA	84.7%	Recycle of Data Memory Unit likely to recover all Printed Wire Assemblies
GNC	IRU	3	3	Full	Performance is nominal. 2 for 3 redundancy
	TAM	2	2	Full	Performance is nominal
	SSST	2	2	Full	Observed minor loss of sensitivity in SSSTs, investigating star catalog or tracker param updates
	CSS	2	2	Full	Performance is nominal
	ESA	2	2	Full	Performance is nominal
	FSS	1	1	Full	Performance is nominal. Not currently used
	RWA	4	4	Full	Performance is nominal. 3 for 4 redundancy
	MTR	3	3	Full	Performance is nominal
Prop	REAs	16	16	Full	Performance is nominal
Instruments	ASTER - SWIR	2	2	10%	Cooler is unable to maintain detector temperature. Science Data is unusable (Fully Saturated) and is no longer being recorded. Still collecting and monitoring Engineering data.
	ASTER - TIR	2	2	Full	Performance is nominal
	ASTER - VNIR	2	2	Full	Performance is nominal
	CERES - Aft	1	1	Full	Performance is nominal
	CERES - Fore	1	1	Full	Performance is nominal
	MISR	2	2	Full	Performance is nominal
	MODIS	2	1	50%	Power Supply #2 failed, Formatter A degraded, cross-strapped. <b>All Science is nominal.</b>
	MOPITT	2	1	50%	Displacer B and Chopper Motor failed. Only 47% of science is valid.



# Terra Hardware Anomalies

1 of 3



Date	Incident	Cause	Response
12/18/1999	Solar Array Blanket Box A-side Failed to indicate Open	Redundant side indicated open. Cause of failure unknown.	Able to deploy mast anyway. Blanket Box was separated. Telemetry failed to indicate so. Component is turned off and never planned to
1/4/2000	PMEA Load Resistor Box (LRB) Circuit 1B Failed while re-enabling LRB circuits after successful HW fire test. LRB circuit 1B telemetry read enabled, but EPC 1 current	(1) LRB 1 or harness would require 2 failures to produce observed signature (2) PMEA 1 PWB has single wiring runs to and from LRB circuit relay and potential single point failure at plated through hole for relay pin	Evaluated EPC operational range. Determined nominal operations can exist at reduced load.
9/24/2000	Solar Array Shunt 10 failed	Cause Unknown. Unsuccessful in identifying a single cause of the anomaly and digging further will require addressing multiple failures.	Nominal operations was able to continue. Reviewed impact to propulsive maneuvers and continue to watch.
5/7/2001	MOPITT Displacer B failed	Cause Unknown.	The compression wave created by the coolers moves the free floating displacer. This side of the compressor needs to continue operating for counterbalance. Operating at a reduced compression to provide some counterbalance but to prevent the free floating displacer from hitting it's stop causing so-called "Ringing Effect". The failed side
6/15/2001	MODIS Power Supply 2 failed	Power Supply Shutdown caused by a thermal runaway condition in one of the two Down Regulator FETs. Suspect a High Energy Particle was the cause of the thermal runaway condition damaging the FET	Switched to Power Supply 1.
8/4/2001	MOPITT Chopper Motor 3 failed	The anomaly likely caused a fuse to blow resulting in a permanent failed chopper motor. Transistor Drive Circuit is likely cause.	This corrupts the science data on channels 5 & 6. Note: Channels 5-8 are the only channels which provided good science data since the Displacer B Anomaly. Fortunately, Chopper 3 stopped at an open or partially open position allowing data to be captured minimizing the
9/10/2002	MODIS Formatter A Timing Errors corrupting Science (Degraded Performance)	Formatter A has had a history of problems which resulted in processing errors. The likely cause of the Formatter Timing Errors is an incorrectly terminated clock signal. Fixed on Aqua.	9/10/02 MODIS Science data was effected. MODIS Formatter Swap to Side B was performed on 9/17/02. Since the switch, no Formatter Errors have been detected and the data quality is excellent.



# Terra Hardware Anomalies

2 of 3



Date	Incident	Cause	Response
5/6/2003	MODIS Solar Diffuser Screen Door Failed to Open	Areas investigated where: Spring problem, Disc skipped over the engagement pin, Screw pull-up due to door overdrive, Disc damage due to door overdrive, Pin damage due to door overdrive and Thermal stress damage which is the most likely cause.	No fix to anomaly has been determined. Instead, the MODIS Solar Diffuser Door was opened on July 2nd, 2003. The door will remain open indefinitely while keeping the Screen door closed. This allows some calibration activities to occur.
12/24/2003	MODIS NADIR Door Micro-Switch fails to indicate Opened	Faulty Switch	Does not impact Science Data Collection.
11/22/2004	MODIS SRCA Lamp #2 Burnt Out	Burnt Out	Using Spare: Lamps #1, 3 and 4
See Comment	SSR Print Wire Assembly (PWA) Over-Current Protection	Suspect Over-current protection falsely tripped during day/night transitions. Recycling the SSR Data Module Unit (DMU) is likely to reset PWAs and return functionality.	PWA-52, DMU-2 (Supersets 102 & 103) occurred on 7/30/03. PWA-26, DMU-1 (Supersets 50 & 51) occurred on 9/24/03. PWA-58, DMU-2 (Supersets 114 & 115) occurred on 9/25/03. PWA-22, DMU-1 (Supersets 42 & 43) occurred on 10/14/03. PWA-6, DMU-1 (Supersets 10 & 11) occurred on 7/31/04. PWA-28, DMU-1 (Supersets 54 & 55) occurred on 8/26/05. PWA-30, DMU-1 (Supersets 58 & 59) occurred on 4/19/07. Swapped DMUs on 6/7/07; Re-allocated buffers (Increased MODIS & MISR; reduced ASTER) PWA-14, DMU-1 (Supersets 26 & 27) occurred on 1/8/10. PWA-15, DMU-1 (Supersets 36 & 37) occurred on 4/2/12.
3/1/2006	MODIS SRCA Lamp #3 Degraded	Degraded	Terra SRCA lamp #3 has degraded significantly. Lamp #3 not to be used again. Terra SRCA lamp operation will follow Aqua SRCA lamp operation -- no 30W lamp configuration. Does not impact Science Data Collection.
9/25/2004	ASTER SWIR Detector Temperature Control degraded. Total loss of useable SWIR science data after 4/08. Declared unuseable on 1/09.	Degraded performance. Suspect temperature gradient within compressor.	ASTER SWIR Compressor unable to maintain ideal detector temperature which initially only impacted capturing bright scenes however, more recently degraded to point of total loss of useable SWIR science data. Multiple attempts were made to restart the compressor with different control temperatures and/or stroke amplitude. Some had limited success, however, degradation continued.



# Terra Hardware Anomalies

3 of 3



Date	Incident	Cause	Response
5/29/2008	Direct Access System Modulator Side 1 (DASM)-1 EPC-1 failed.	Continuing to Investigate	Attempt to power cycle on 6/4/08 was unsuccessful. On 6/13/08, Switched to DASM-2 cross-strapped with Up-Converter-1 and Solid State Power Amplifier-1. Continue with normal operations.
10/13/2009	Hex Bay Battery Assembly (BBAT) heater control failed on 4 of 9 heater groups.	Continuing to Investigate. Internal heater element or heater connector/wire only remaining probable causes. Suspect impact from Micro-meteoroid or Orbital Debris (MMOD)	Attempted to recover by soft recycle, power cycle side A, and switch to side B of HCE-5A. Beginning 10/13/09, four of nine heater groups in BBAT are unable to provide temperature control. Battery cell charging/discharging and the remaining five heater groups are preventing cells from freezing. Both primary (HCE-5A side A), redundant (HCE-5A side B), and survival heaters are affected and all indications are that it is nonrecoverable
10/13/2009	Hex Bay Battery Assembly (BBAT) cell #50 failed.	Loss of cell pressure. Suspect impact from Micro-meteoroid Orbital Debris (MMOD).	Bypass switch for BBAT cell #50 tripped on 10/15/09. Cell voltage is near zero.
10/3/2009	MOPITT Sieve 3 Heater Control Circuit Failure	Cause Unknown.	None, this heater was operating as a control heater for a molecular sieve that was not being used due a cooler system malfunction years ago. The removal of this small amount of heat will cause no thermal problems with CPHTS, the main MOPITT thermal control system.
12/2/2010	MOPITT Sieve 1 Heater Control Circuit Failure	Cause Unknown.	None, this heater was operating as a control heater for a molecular sieve that was not being used due a cooler system malfunction years ago. The removal of this small amount of heat will cause no thermal problems with CPHTS, the main MOPITT thermal control system.
11/10/2005	SAA Isc temperature sensor B Failure	Cause Unknown.	None, this sensor is used to help understand the degradation rate of the solar array. All other telemetry associated to power and Solar Array performance indicates only the temperature sensor has been affected.
9/28/2008	SAA Isc temperature sensor A Failure	Cause Unknown.	None, this sensor is used to help understand the degradation rate of the solar array. All other telemetry associated to power and Solar Array performance indicates only the temperature sensor has been affected.
1/12/2012	SAA Voc temperature sensor A Failure	Cause Unknown.	None, this sensor is used to help understand the degradation rate of the solar array. All other telemetry associated to power and Solar Array performance indicates only the temperature sensor has been affected.