



The Pathfinder Mission for Climate Absolute Radiance and Refractivity Observatory

AOGS

Advances in Optical Remote Sensing Of Atmosphere

Thursday, August 4 (11:00am-12:30pm)

R. R. Baize, C. Boyer, R. Cageao, C. Currey, G. A. Fleming, T. Jackson, D. G. Johnson, J. Leckey, X. Liu, C. Lukashin, J. McCorkel, M. G. Mlynczak, Y. Shea, K. J. Thome, B. A. Wielicki, NASA; W. Sun, SSAI

- **The Climate Observing Challenge**
- **Critical Problems CLARREO Helps Solve**
- **The Pathfinder**
 - ✓ *Science*
 - ✓ *Measurement*
 - ✓ *Mission Concept*
 - ✓ *Mission Urgency*
- **Contributions of the Science Definition Team – Impact**
- **Next steps**



The Climate Observing Challenge



- Warming of the climate system is unequivocal, and since the 1950s, many of the observed changes are unprecedented over decades to millennia. The atmosphere and ocean have warmed, the amounts of snow and ice have diminished, and sea level has risen. (IPCC Climate Change Report 2014)
- So that informed decisions can be made on prevention, mitigation, and adaptation strategies observations must be sustained into the future to evaluate how the climate is changing (Global Observing System for Climate in Support of the UNFCCC 2010).
- Gaps in our ability to observe these changes will lead to deficiencies in our understanding and our ability to develop an effective response.
- Need to narrow uncertainties in climate change observations and projections (e.g. climate change trends, climate sensitivity) much more rapidly than current observations



CLARREO = Climate Absolute Radiance and Refractivity Observatory

- CLARREO was recommended as a top priority for NASA by the National Academy of Science
 - The [2007 Decadal Survey](#) concluded that the single most critical issue for current climate change observations was their [lack of accuracy](#) and low confidence in observing the small climate change signals over long decade time scales.
 - CLARREO can help an advanced climate observing system advance uncertainty in climate change trends and climate sensitivity by 15 to 20 years (Wielicki et al. 2013)
 - Advance accuracy a factor of 5 to 10 for observing global climate change from space

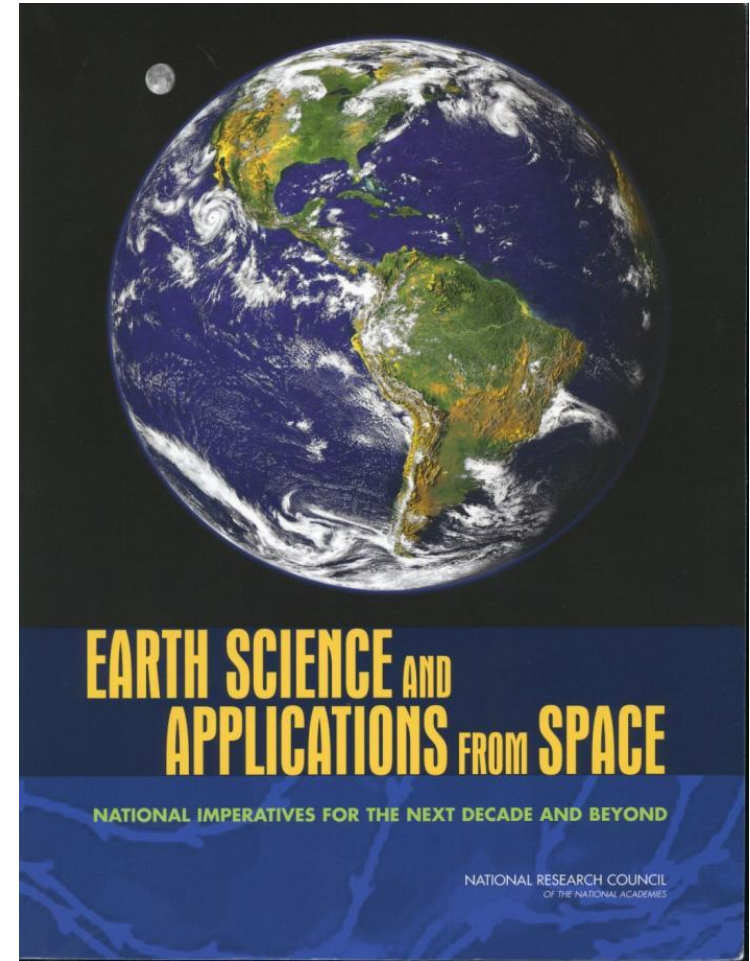

- **The Climate Observing Challenge**
- **Critical Problems CLARREO Helps Solve**
- **The Pathfinder** ←
 - ✓ *Science*
 - ✓ *Measurement*
 - ✓ *Mission Concept on ISS*
- **Mission Urgency – Near Term Impact**
- **Next steps**



Earth Science

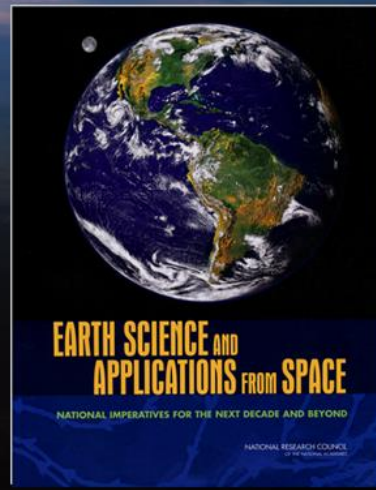
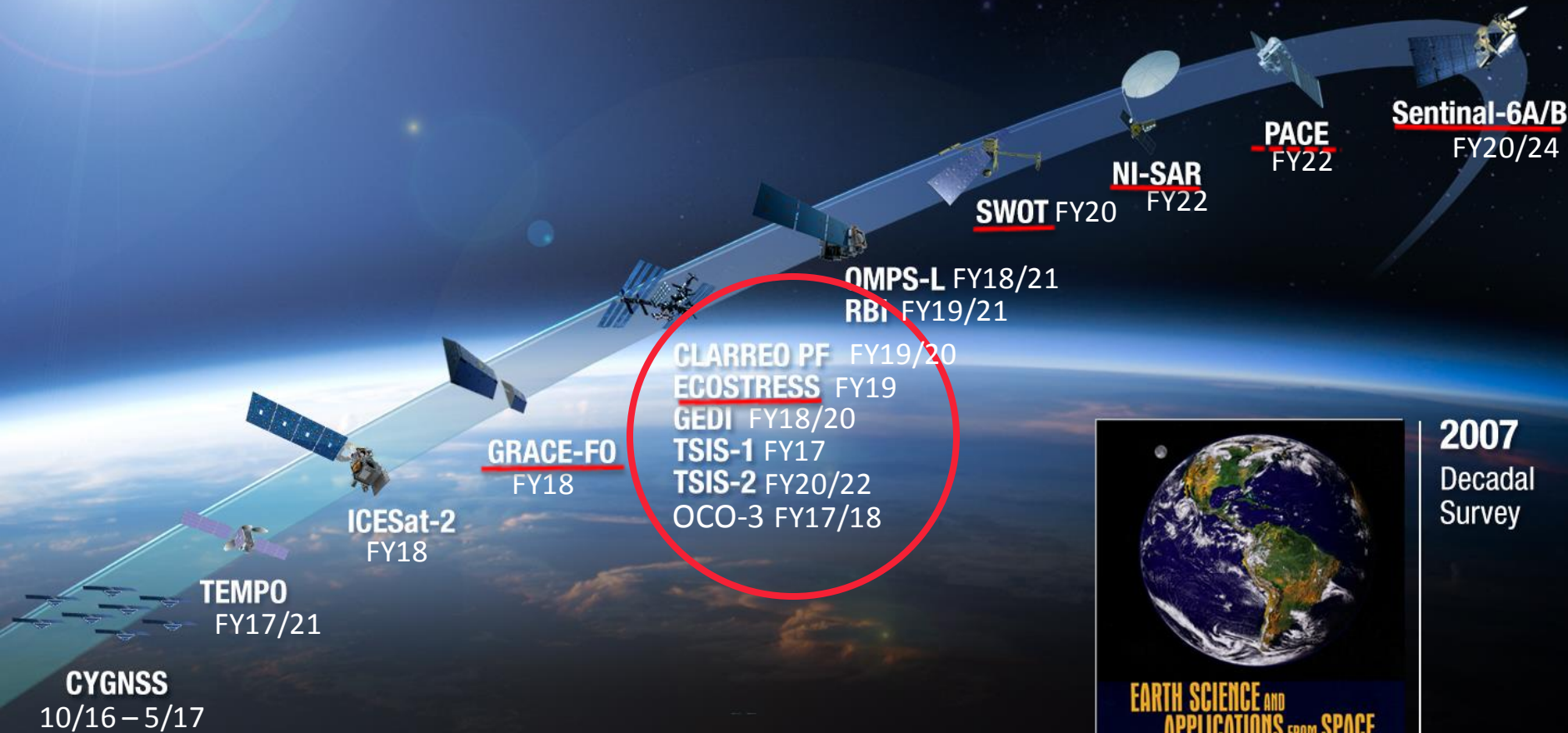

2007
Decadal
Survey

CLARREO Pathfinder on ISS



- *Demonstrate essential measurement technologies for the **Reflected Solar** portions of the CLARREO Tier 1 Decadal Survey Mission*
 - Demonstrate on orbit, high accuracy, SI-Traceable calibration
 - Demonstrate ability to transfer to other on-orbit assets
- Formulation, implementation, launch, operation, and analysis of measurements from a Reflected Solar (RS) Spectrometer, launched to the International Space Station (ISS)
- Category 3 / **Class D Mission**, nominal 1-year mission life + 1 year science data analysis
- Target instrument **launch date as early as CY2020**
- Authority to Proceed received April 11, 2016. Mission Concept Review August 25, 2016.

CLARREO Pathfinder will improve accuracy across Earth Sciences



CLARREO Pathfinder Science on ISS



- Demonstrate CLARREO calibration accuracy for the **reflected solar spectrometer** on International Space Station (Infrared spectrometer did not fit within the current budget)
- Lessons learned from CLARREO Pathfinder will benefit a future CLARREO mission
 - Reduced risk
 - Demonstration of **higher accuracy** calibration approaches
 - Prove that high accuracy **SI-traceability can be transferred on orbit**
 - Show that high accuracy **intercalibration** is achievable
- CLARREO Pathfinder will demonstrate highest accuracy reflectance measurements from orbit
 - First on-orbit SI-traceable reflectance with uncertainty $<0.5\%$ ($k=2$)
- Lessons learned from CLARREO Pathfinder will produce benefits across many NASA Earth Science Missions and International Missions
 - Improved laboratory calibration approaches
 - Development and testing of innovative on-orbit SI-traceable methods
 - Transfer calibration to sensors in operation at time of CLARREO Pathfinder
 - Improved lunar irradiance standard

CLARREO Pathfinder will improve accuracy across Earth Sciences



CLARREO Pathfinder Science Objectives



Demonstrate high accuracy SI-Traceable Calibration

Demonstrate Inter-Calibration Capabilities

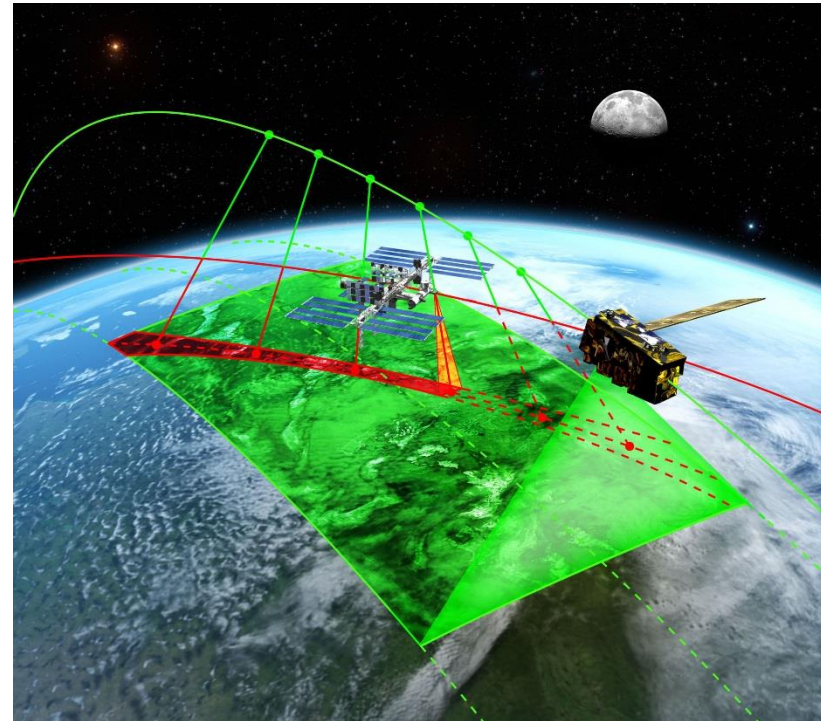
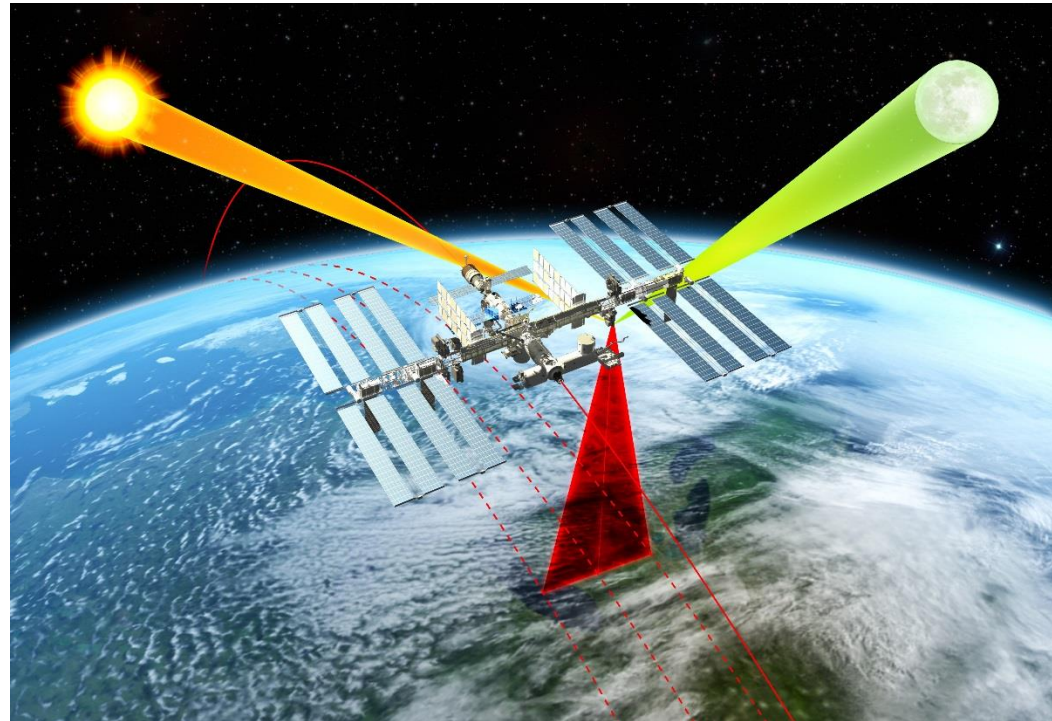

Objective #1: Demonstrate the ability to conduct, on orbit, SI-Traceable calibration of measured scene spectral reflectance, with an advance in accuracy over current on-orbit sensors

Objective #2: Demonstrate the ability to use that improved accuracy to serve as an in orbit reference spectrometer for intercalibration of other key satellite sensors across most of the reflected solar spectrum.



- **The Climate Observing Challenge**
- **Critical Problems CLARREO Helps Solve**
- **The Pathfinder**
 - ✓ *Science*
 - ✓ *Measurement* ←
 - ✓ *Mission Concept on ISS*
- **Mission Urgency – Near Term Impact**
- **Next steps**





Infrared (IR) Instrument

Fourier Transform Spectrometer

- Systematic error less than 0.1K ($k=3$)
- 200 – 2000 cm^{-1} contiguous spectral coverage
- 0.5 cm^{-1} unapodized spectral resolution
- 25 km nadir fov, 1 earth sample every 200 km
- *Mass: 76 Kg*
- *Power: 124 W*

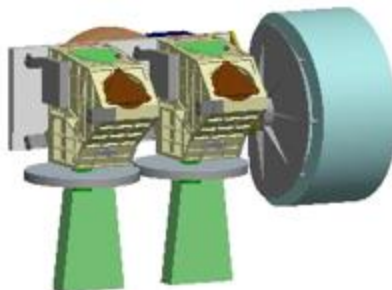

Reflected Solar (RS) Instrument

Two Grating Spectrometers Gimbal-mounted (1-axis)

- Systematic error less than 0.3% ($k=2$) of earth mean reflectance
- 320 – 2300 nm contiguous spectral coverage
- 4 nm sampling, 8 nm res
- 300 m fov, 100 km swath
- *Mass: 67 Kg*
- *Power: 96 W*
- *Power and Mass are total for both spectrometers*



GNSS Radio Occultation Receiver

GNSS Receiver, POD Antenna, RO Antennae

- Refractivity uncertainty 0.03% ($k=1$) for 5 to 20 km altitude range. (Equivalent to 0.1K ($k=3$) for temperature)
- 1000 occultations/day
- *Mass: 18 Kg*
- *Power: 35 W*



RS Spectrometer Concept Design

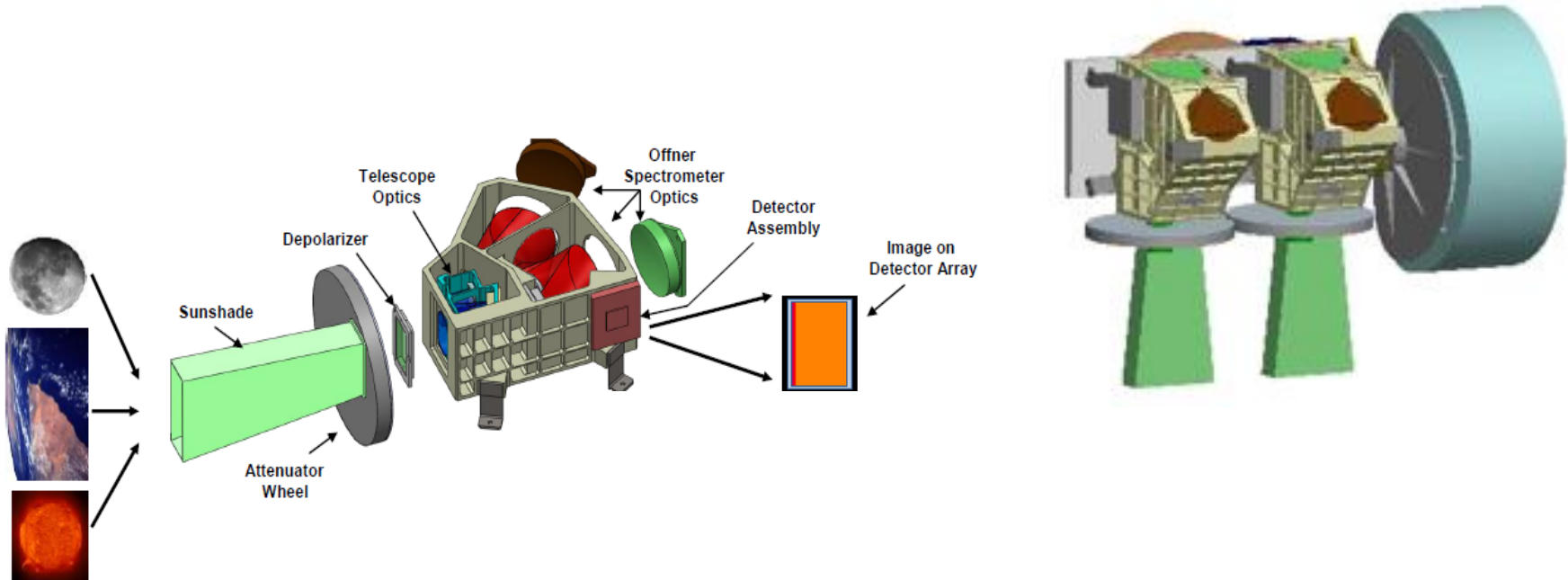

- RS Calibration Demonstration Breadboard developed and in test.
 - Successfully demonstrated the measurement approach.
 - incorporated NIST calibration advancements
- Concurrent Earth Science Technology Office investments
 - Successfully matured the required technologies to TRL=6.



- **The Climate Observing Challenge**
- **Critical Problems CLARREO Helps Solve**
- **The Pathfinder**
 - ✓ *Science*
 - ✓ *Measurement*
 - ✓ *Mission Concept on ISS* ←
- **Mission Urgency – Near Term Impact**
- **Next steps**



Reflected Solar Spectrometer on EXPRESS Pallet Adapter (ExPA)



EXPRESS Pallet Adapter (ExPA)

RS Spectrometer

Instrument Control and
ISS Interface Electronics

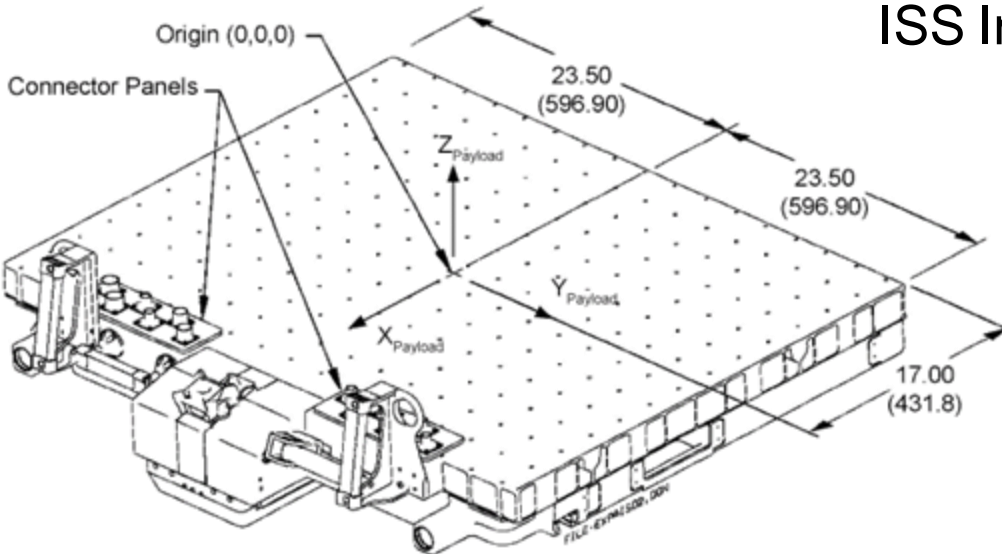
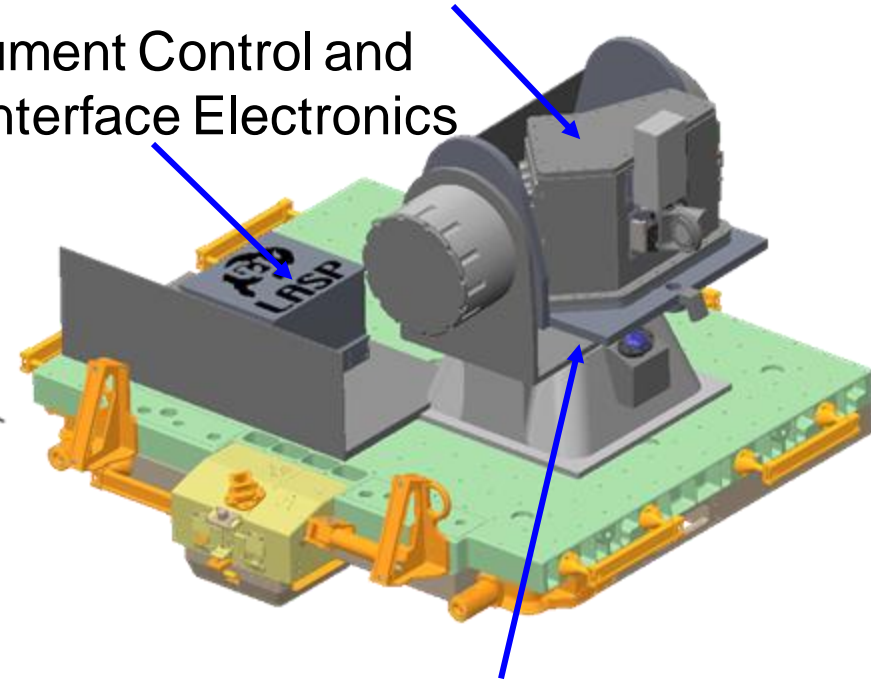

Figure 3.1.1-4. Generic ExPA payload coordinate system.



Two-Axis Pointing System

- Will make use of ISS wireless data transfer infrastructure for data transfer to ISS and subsequent telemetry downlink





CLARREO Pathfinder: Location on ISS: ELC-1 Site #3

- CLARREO Pathfinder Payload will be installed on ExPRESS Logistics Carrier #1 (ELC-1) Site #3

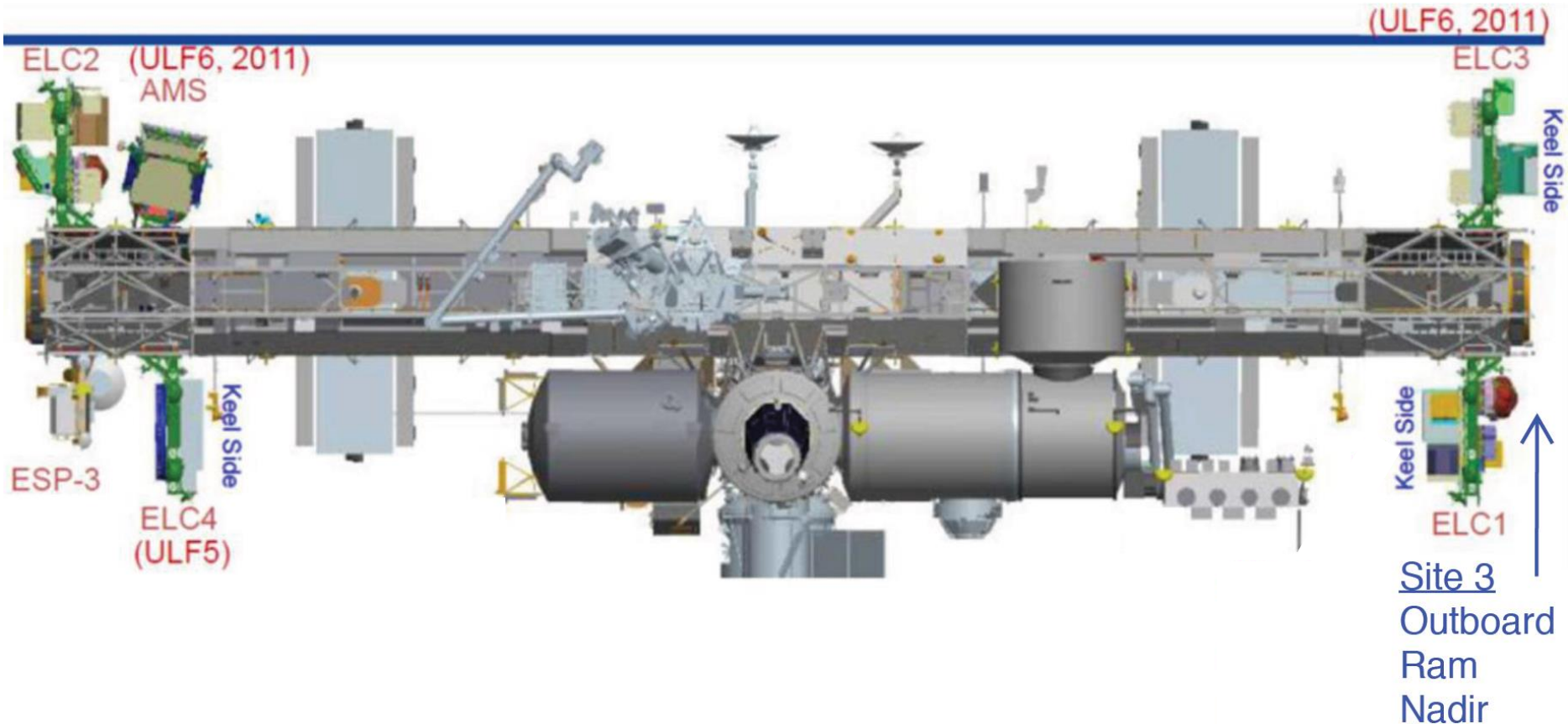

Orientation: ISS flying out of the page towards the reader



ISS Orientation



ELC-1 Site 3

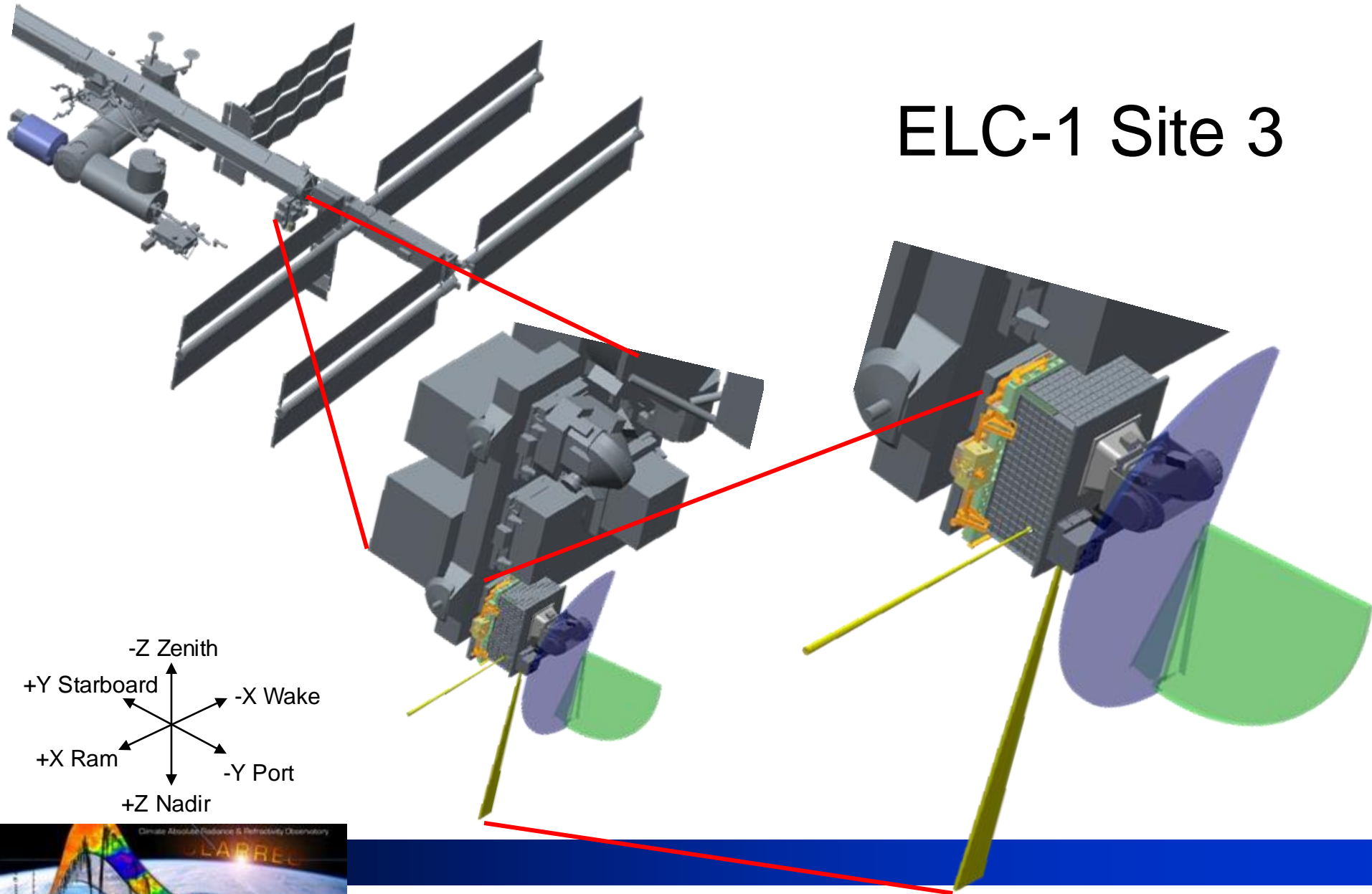

ELC Accommodations

ELC Single Adapter Resources

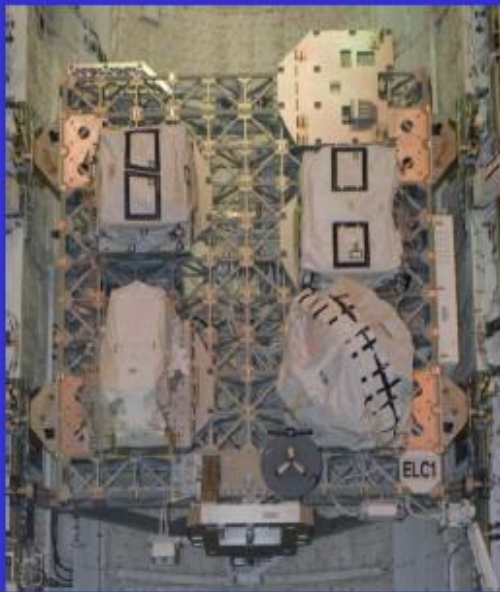

Mass Capacity	227 kg (500lb)	✓
Volume	1m ³	✓
Power	750W, 113-126 VDC 500W at 28 VDC per adapter	✓
Thermal	Active heating, passive cooling	✓
Low-rate data	1 Mbps (MIL-STD-1553)	
Medium-rate data	6 Mbps (shared)	
Sites available per ELC	2 sites	
Total ELC sites available	8 sites	

Note: On-orbit external wireless high rate (100 Mbps capability) upgrade in work

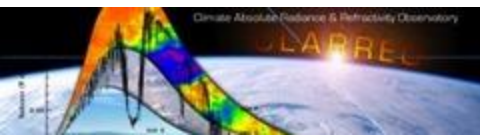

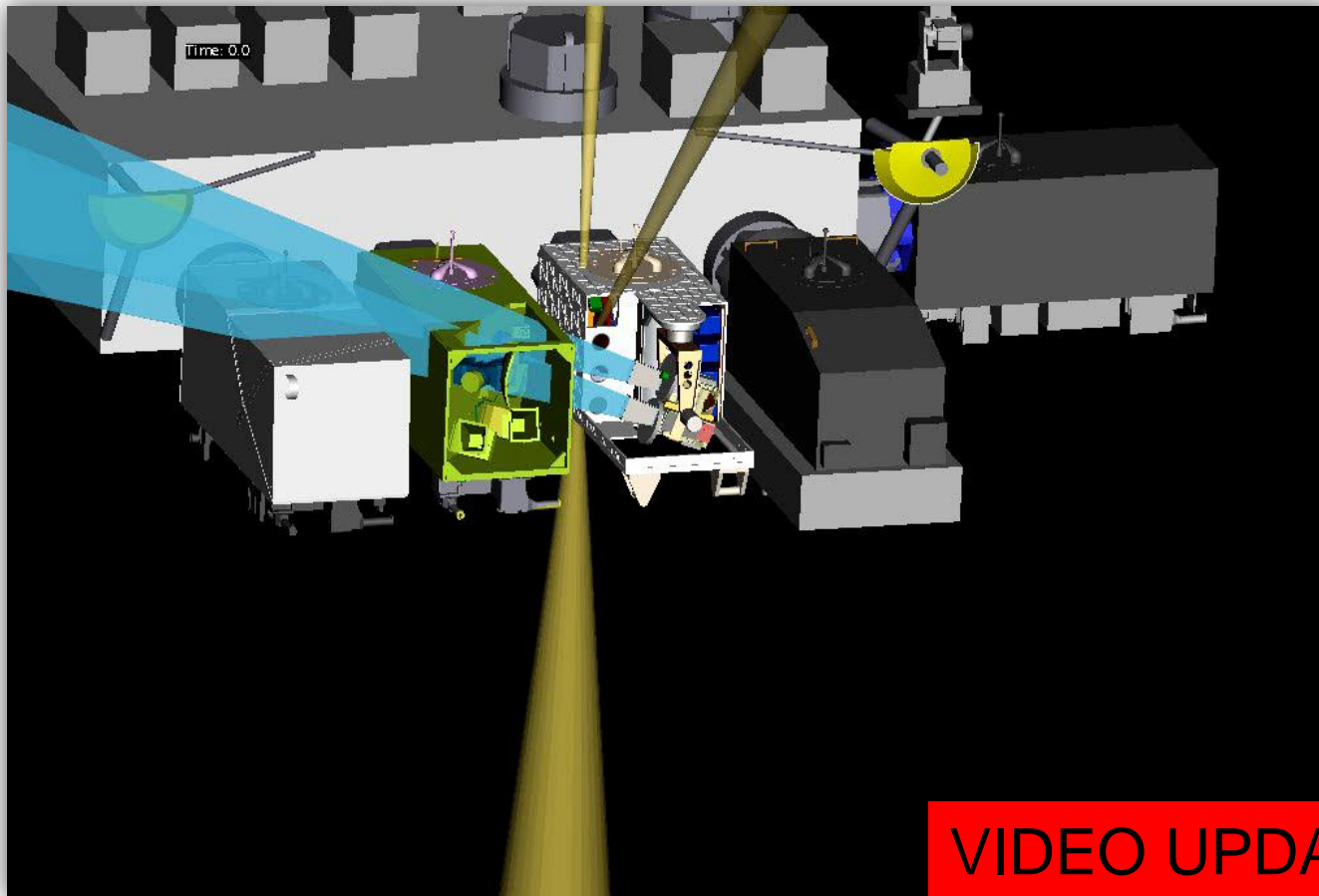

VIDEO UPDATE??

Preliminary studies show that the mass, power, volume, and thermal requirements are within a reasonable ISS design space.

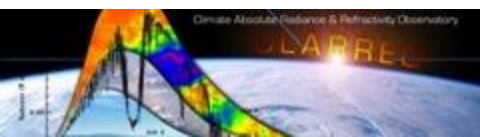

Instrument Operations



- Instrument will perform nadir observations during the daylight portion of every orbit
 - Scene selection and data compression maximize data capture during available science data downlinks
- Solar/lunar calibration will be performed intermittently (as 6 minute accesses available)
- Full resolution scenes will be taken periodically to demonstrate the full capabilities of instrument, provide diagnostic capabilities for assessing performance, and advance the data analysis and data compression tools
- Lower spatial resolution scenes may be binned to higher spectral/spatial resolution for initiating a climate benchmark-quality data series

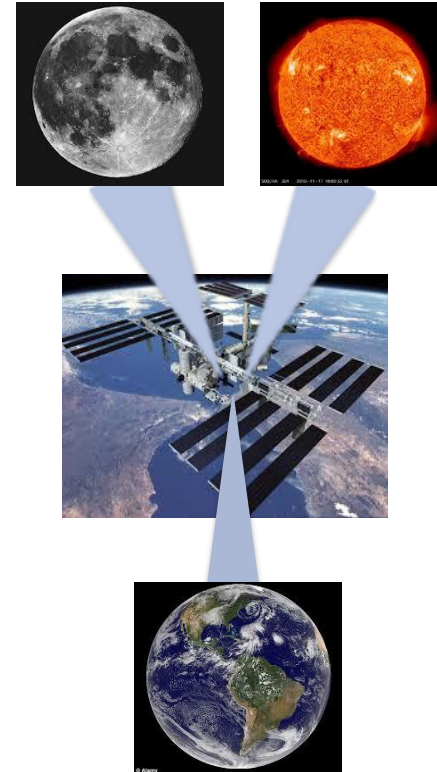

- **The Climate Observing Challenge**
- **Critical Problems CLARREO Helps Solve**
- **The Pathfinder**
 - ✓ *Science*
 - ✓ *Measurement*
 - ✓ *Mission Concept on ISS*
- **Mission Urgency – Near Term Impact** ←
- **Next steps**



Near-Term Science Impact (<1 year)



- Providing a year of on-orbit crossing data with Suomi-NPP, JPSS-1, MetOP, Terra, Aqua, and geostationary satellites (5 for global coverage). The Pathfinder's technology demonstration only includes inter-calibration with CERES and VIIRS;
- Demonstrating the use of the RS spectrometer as a reference instrument for inter-calibration as part of GSICS (Global Space Based Inter-Calibration System);
- Putting the lunar spectral irradiance on an SI-traceable scale with 10 to 20 times the current accuracy of 5 to 10% ($k=1$);
- Potentially characterizing a sample of surface sites such as Dome-C and the Libyan desert for Landsat inter-calibration and demonstrating the capability of an accurate surface BRDF spectral product for the full CLARREO mission.

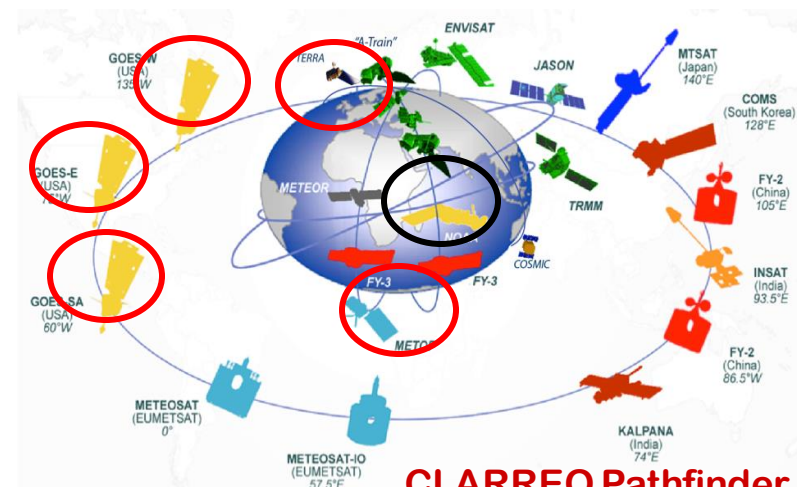
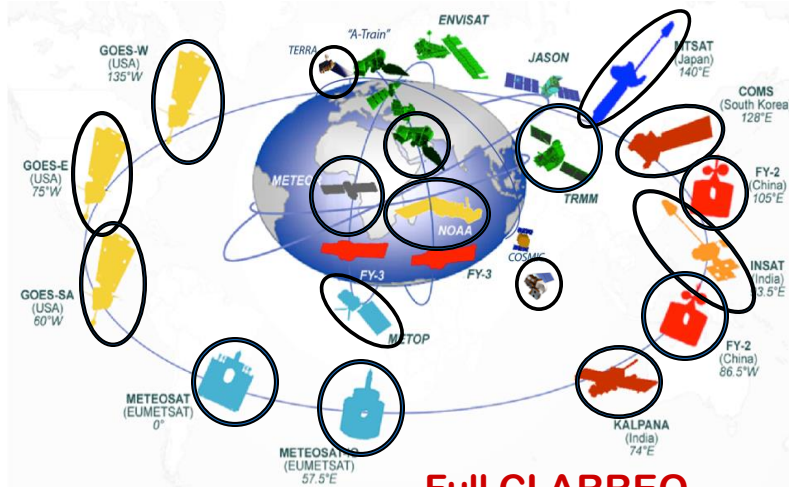

Full CLARREO

CLARREO Pathfinder

Benefits and linkages to other missions



Data Products

- L0, Cal, L1 data products produced at LASP
- L4 Intercalibration products produced at LaRC

Data Product	Description
L0	<ul style="list-style-type: none"> - All science telemetry, time ordered, duplicate packets removed
Calibration	<ul style="list-style-type: none"> - Solar (flat field and irradiance) - Lunar (flat field and irradiance)
L1B Nadir Benchmark	<ul style="list-style-type: none"> - Spectral band averages (30), full spatial (0.5 km) - 10 km average, full spectral
L1B IC	<ul style="list-style-type: none"> - Full resolution (spatial and spectral) - LEO and GEO targets - Lunar irradiance (use for lunar model) - Surface Sites
L4 IC	<ul style="list-style-type: none"> - CERES matched - VIIRS matched



CLARREO Pathfinder Reference Schedule

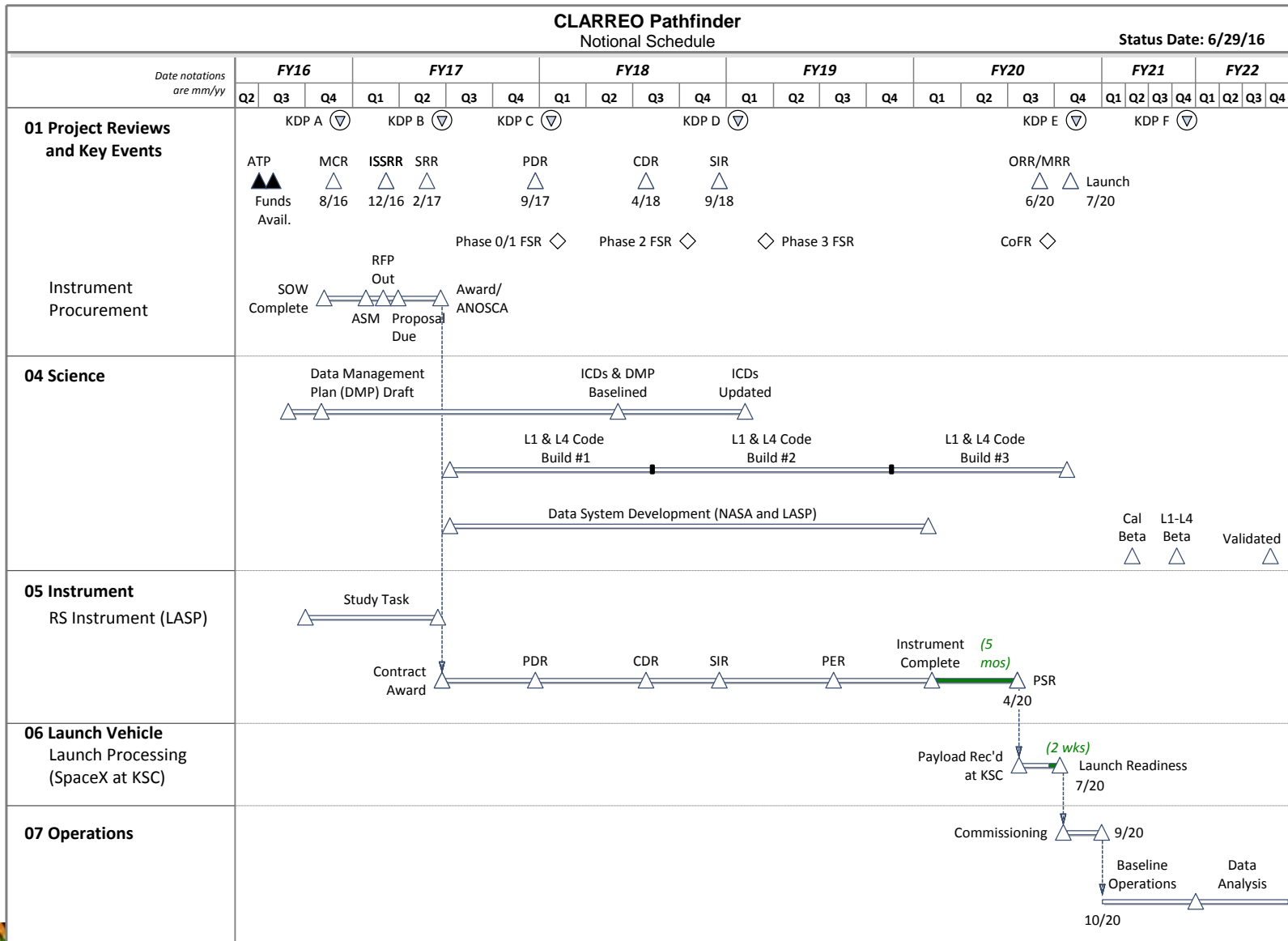

Approximately 3 ¾ years from Project Confirmation (KDP-A) to Launch



- **The Climate Observing Challenge**
- **Critical Problems CLARREO Helps Solve**
- **The Pathfinder**
 - ✓ *Science*
 - ✓ *Measurement*
 - ✓ *Mission Concept on ISS*
- **Mission Urgency – Near Term Impact**
- **Next steps** 

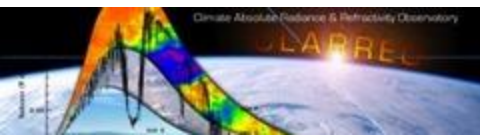

Next Steps



- Progress to date
 - Authority to Proceed Received April
 - LaRC 60-Day Project Review June
 - ISS Accommodations Review/Site Selection July
- Planned Major Life Cycle Reviews and Dates (all dates TBR)
 - **Mission Concept Review** August 25, 2016
 - System Requirements Review Feb/Mar 2017 (may tailor)
 - Preliminary Design Review September 2017
 - Critical Design Review April 2018
 - Pre-Ship / Integration Review April 2020
 - Operations Readiness Review June 2020



- Back-up





Contributions of the Science Definition Team (2016)

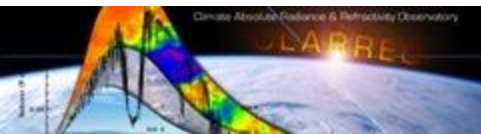

- Despite the fact that CLARREO is not on-orbit the SDT is making important contributions to the tools/methods that help us understand and assess climate trends
- 26 journal papers published/in press in 2014. In total, 105 papers (to date) have been included in <https://esdpubs.nasa.gov/>
- Published CLARREO mission paper (20 pgs) as **cover article** in Bulletin of the American Meteorological Society (BAMS, Oct 2013).

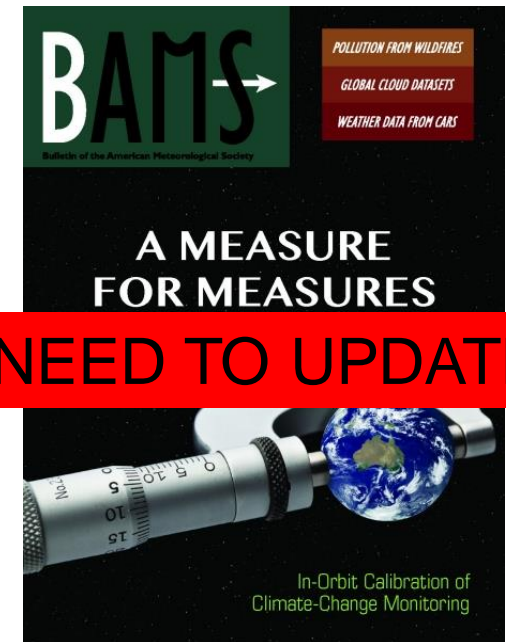

Would you like to learn more about CLARREO

Get online:

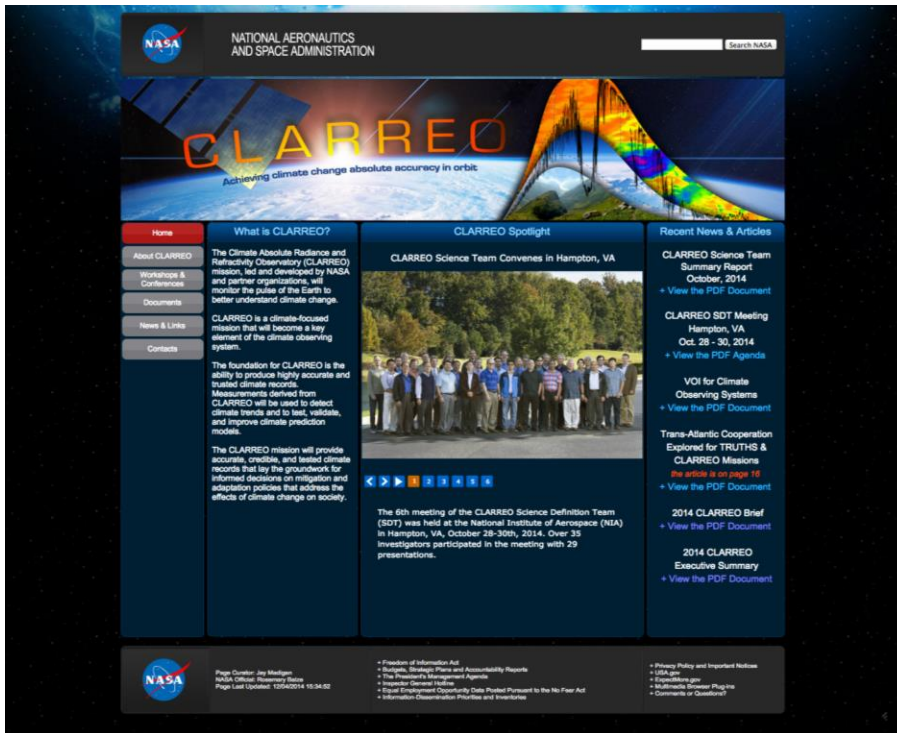

CLARREO Website:



Talk to
CLARREO team



Visit the CLARREO website:
<http://clarreo.larc.nasa.gov/>

Thank You!

- **Infrared and Reflected Solar Benchmark**

- Developed IR and RS radiometric and spectral calibration methodologies/tools. Applied knowledge to VIIRS, RBI, CrIS, Landsat calibration efforts.
 - *Impact:* Demonstration of first on-orbit SI traceable calibration methods to achieve accuracies 5 to 10x higher than current IR and RS instruments. Put the lunar spectral irradiance on an SI traceable scale with 10 to 20 times the current accuracy of 5 to 10 % (1 sigma). First far-infrared measurements since Nimbus.

- **Reference Intercalibration**

- Provided methodologies to enable CLARREO to tie 30 to 40 Earth viewing sensors in LEO and GEO orbits to higher accuracy standard on-orbit.
- Multi-instrument inter-calibration framework to be deployed at NASA/NOAA.
 - *Impact:* Provide on orbit crossings with NPP, JPSS1, METOP, Terra, Aqua, and geostationary satellites (5 for global coverage). Demonstrate the use of both IR and RS as reference instruments for intercalibration as part of GSICS (Global Space Based Inter-Calibration System).

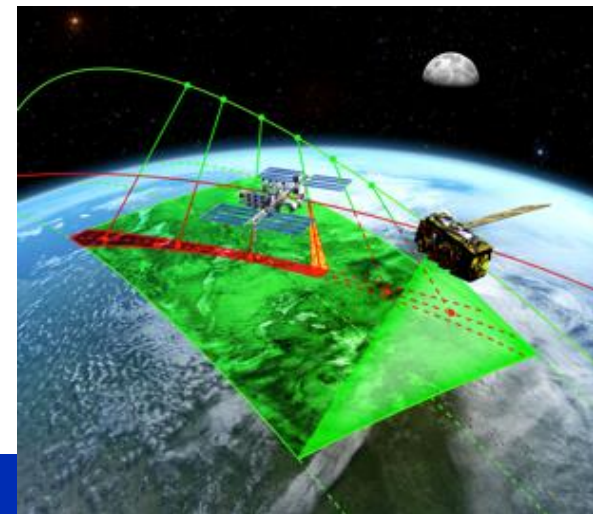

Global Satellite Observations

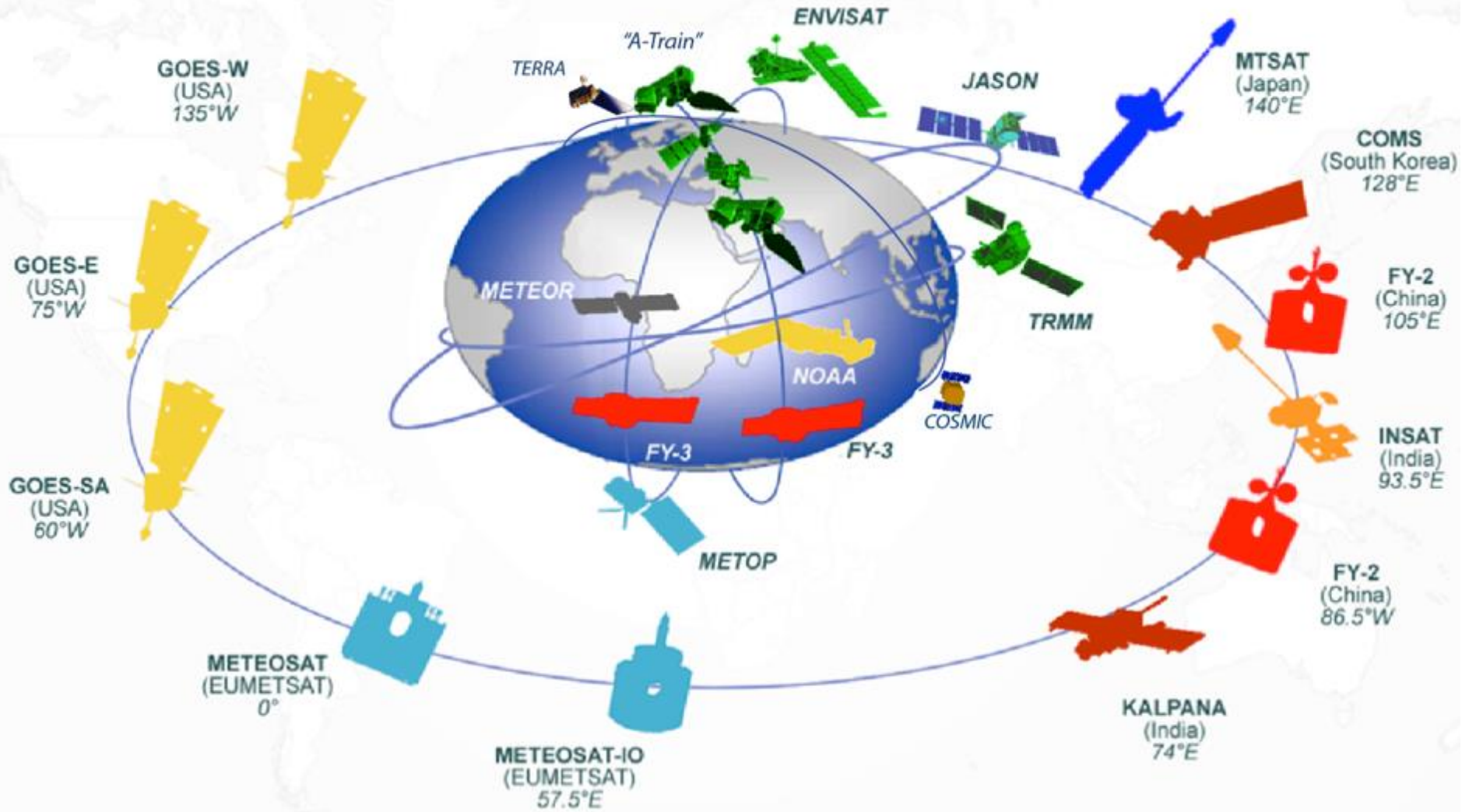

Intercalibration to CLARREO for Climate Change Accuracy

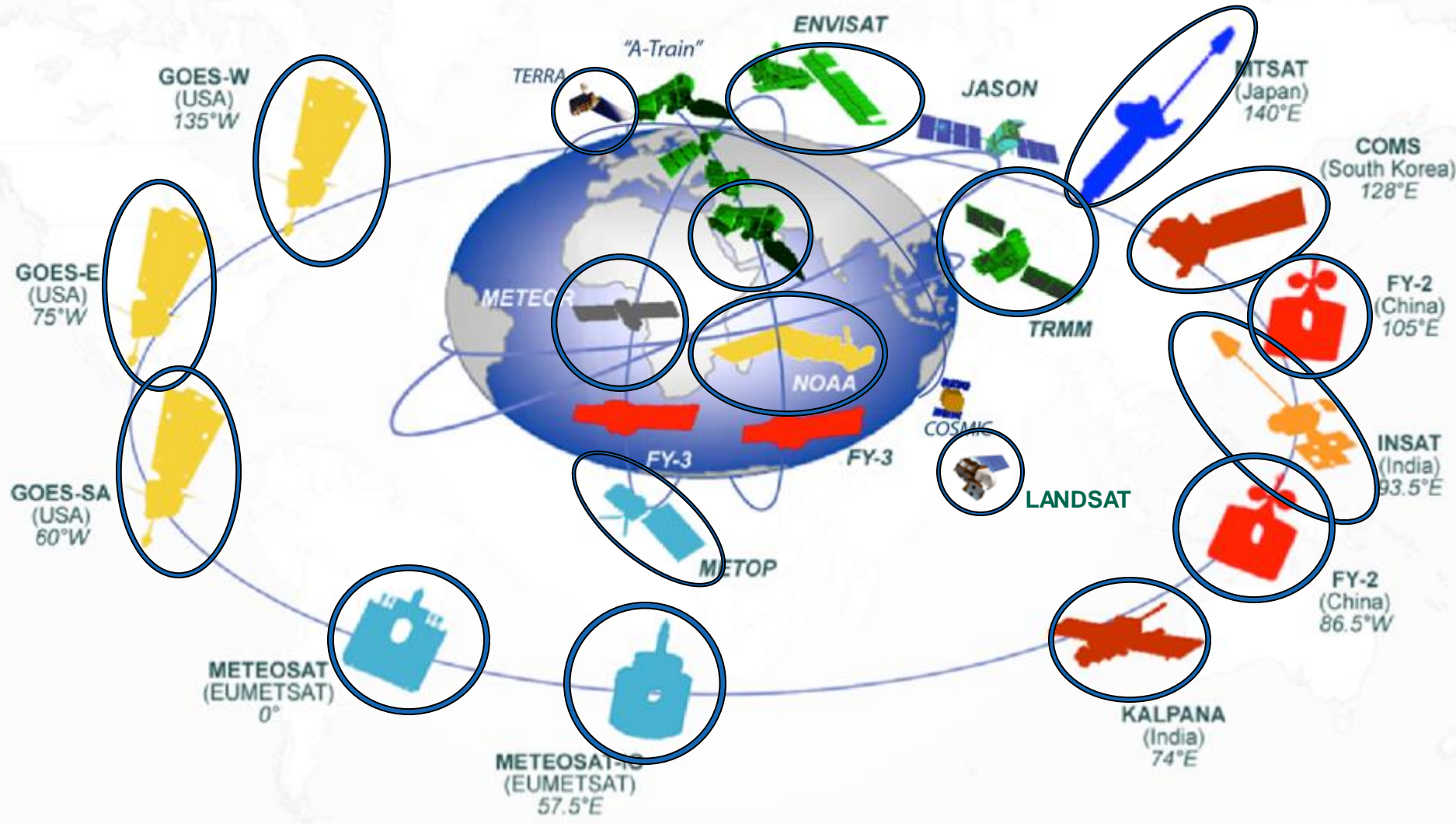

Intercalibration of 30 to 40 instruments in LEO and GEO orbits

- **Observing Systems Simulation Experiments (OSSEs)**

- Developed first combined IR/RS CLARREO OSSEs (Feldman 2013). Use models as “perfect worlds” for application of CLARREO spectra.
- Demonstrated CLARREO ability to discriminate between low and high sensitivity climate models, which is critical for climate science (WCRP Grand Challenge #1).
- *Impact:* Modeling community utilizes CLARREO all-sky radiances for evaluation and assimilation. Sufficient data provide climate model tests.

- **Climate Trend Detection and Attribution**

- Tested LW and SW Spectral Fingerprinting with real world and simulated observations
- Retrieved atmospheric changes from hyperspectral data using Principal Component Radiative Transfer Modeling (25-30x speedup versus Modtran). Enabled larger number of simulations for examining signatures of climate change.
- Goal: To find the spectral kernels that best represent the true radiative response in nature and use it to attribute changes seen in the observational data. Good correlations with CERES/MODIS and Sciamachy data sets.
- *Impact:* Retrieve atmospheric changes from CLARREO hyperspectral datasets.

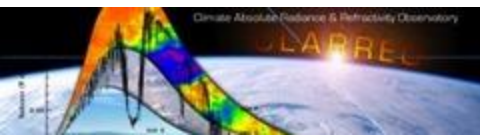

Technical Maturity

- **Earth Venture Solicitations (EV-2 and EVI-1)**
 - CLARREO-like instruments assessed at TRL 6 or higher; Reflected Solar concept received low risk rating
- **RS and IR Calibration Demonstration Breadboards developed and in test.**
 - Successfully demonstrated the measurement approach.
 - incorporated NIST calibration advancements (FY13-14).
- **Concurrent Earth Science Technology Office investments**
 - Successfully matured the required technologies to TRL=6.

Solar Observation Technologies

HyperSpectral Imager for Climate Science (HySICS)
PI: Greg Kopp
IIP-2007 & 10/LASP



Mid and Far-IR Observation Technologies

End-to-End Verification Tests of the UW Absolute Radiance Interferometer (ARI) in a Vacuum Environment
PI: Henry Revercomb
IIP-07 follow-on/UW



Absolute Calibration of Far-Infrared Spectrometers
PI: Marty Mlynczak
QRS-11/LaRC



CLARREO Alternate Mission Options

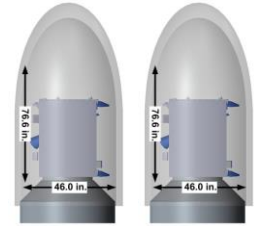
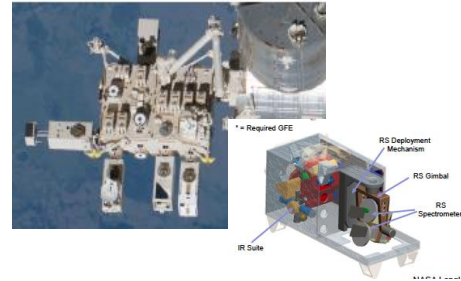
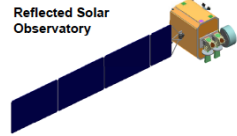
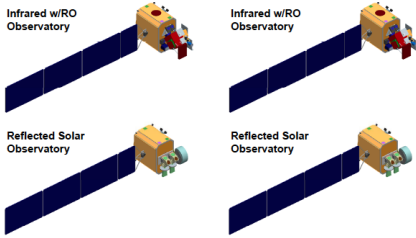

MCR Concept
(100% Science)

MCR Minimum
Mission Concept
(62% Science)

ISS Mission
Concept
(73% Science)

Smaller Mission
Class
(85% of Science -
Polar Latitudes)

**\$950M- 1.2B Est.
Total Cost**

**~\$675M
+ Launch**

**~\$420M
Total Cost**

**~\$400 M
Total Cost
(~\$200M Single)**

**6 instruments,
4 small (or 2 medium
spacecraft),
2 launches**

**3 instruments,
1 medium-sized
spacecraft,
1 launch**

**2 instruments on
ISS, RO is obtained
from COSMIC-2
(LRD 2023)**

**Lower cost, smaller
instruments (either
IR or RS).**

Baseline

**Cost Reduction
~\$325M +
Launch Vehicle**

**Cost Reduction
~\$600M**

**Cost Reduction
~\$800M**





- **Provide climate-accuracy calibration for operational sensors**
 - An orbiting calibration observatory that can be used to calibrate other solar and infrared space-borne sensors and thereby improve climate accuracy of a wide range of sensor measurements across the Earth observing system
- **Dramatically reduce the effects of data gaps**
 - The absolute accuracy of CLARREO, when used to calibrate other sensors in orbit can dramatically reduce the impact of data gaps on decadal change data records across many climate variables
- **Provide space-based measurements of the Earth's far infrared spectrum**
 - Opens a new window to 50% of Earth's outgoing long wave energy with key information on water vapor feedback, cirrus radiative forcing, and the natural greenhouse effect
- **Improve assessment of climate predictions for public policy**
 - CLARREO will measure solar reflected and infrared emitted high spectral resolution benchmark radiance climate data records that can be used to test climate model predictions, improve climate change fingerprinting, and attribution





Infrared (IR) Instrument

Fourier Transform Spectrometer

- Systematic error less than 0.1K ($k=3$)
- 200 – 2000 cm^{-1} contiguous spectral coverage
- 0.5 cm^{-1} unapodized spectral resolution
- 25 km nadir fov, 1 earth sample every 200 km
- *Mass: 76 Kg*
- *Power: 124 W*

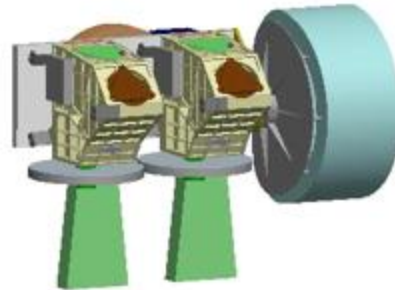

Reflected Solar (RS) Instrument

Two Grating Spectrometers Gimbal-mounted (1-axis)

- Systematic error less than 0.3% ($k=2$) of earth mean reflectance
- 320 – 2300 nm contiguous spectral coverage
- 4 nm sampling, 8 nm res
- 300 m fov, 100 km swath
- *Mass: 67 Kg*
- *Power: 96 W*
- *Power and Mass are total for both spectrometers*



GNSS Radio Occultation Receiver

GNSS Receiver, POD Antenna, RO Antennae

- Refractivity uncertainty 0.03% ($k=1$) for 5 to 20 km altitude range. (Equivalent to 0.1K ($k=3$) for temperature)
- 1000 occultations/day
- *Mass: 18 Kg*
- *Power: 35 W*



Scientific Value of Mission Concept



- Increases accuracy of climate observing system through reference intercalibration
 - The absolute accuracy reduces the need for overlap between successive instruments
- Reduces levels of uncertainty in climate change projections (15-20 years earlier)
- Lower cost implementation option may lead to initiating the climate record sooner
- Follow-on missions could continue the data record from free-flyers in different inclinations and altitudes (i.e., not locked in to ISS for follow-on)
- Provides spectral measurements in the far-IR, a region of the spectrum that has been largely unobserved from space
- Large number of SDT peer-reviewed journal publications: 72 papers posted to date (<https://esdpubs.nasa.gov/>)
- Developed methodology broadly applicable to understanding the economic value of climate science (http://clarreo.larc.nasa.gov/pdf/articles/VOI-ForClimateObservingSystems_Springer.pdf)
- Letters of support GSCIS, WMO, GCOS



CLARREO - Overview

Science Value:

- **Climate Benchmark** (*Decadal Survey Tier 1 mission*): Fills the critical need for unambiguous climate change measurements with a high level of accuracy (improved by factors of 5 to 10).
- Used to detect climate trends and to test, validate, and improve climate prediction models.
- **Standard for Intercalibration**: Provides a metrology laboratory in orbit for the purpose of accurately quantifying/attributing climate change.
- Benchmark for GSICS to tie 30 to 40 Earth viewing sensors in LEO and GEO orbits to a higher accuracy.
- **Discovery Science**: Provides the first spectral observations of Earth's far-infrared, which includes 50% of Earth's energy emitted to space.

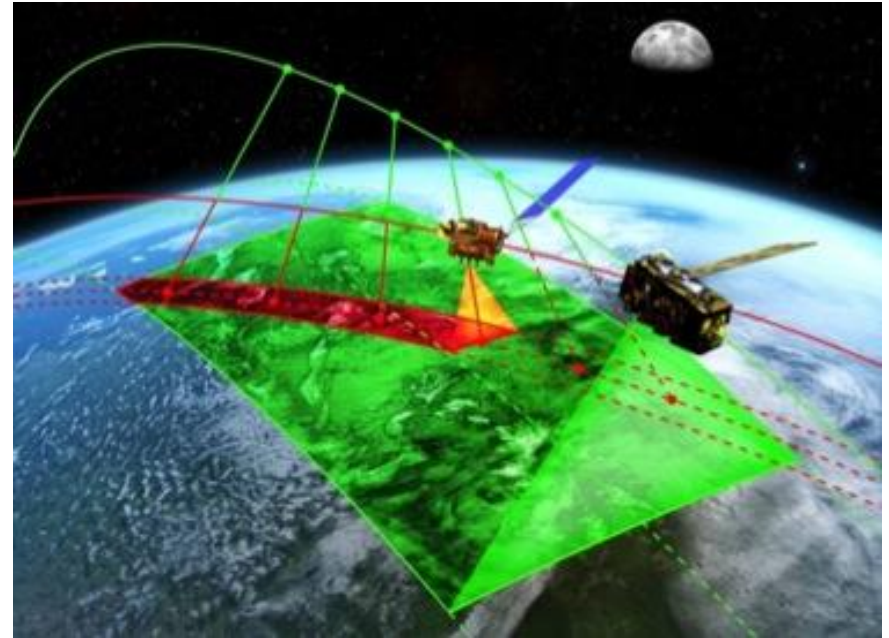

Study Status:

- Passed Mission Concept Review in Nov 2010. Currently in pre-phase A.
- Advanced measurement design maturity (all components now TRL 6) and incorporated NIST calibration approaches (FY13-14).
- CLARREORS and IR payloads compatible with ISS hosting (FY13).
- Focus on lower cost, smaller instruments with ability to achieve required accuracy on-orbit (FY14).

Teaming:

- Project Team: LaRC, GSFC, JPL. Competitively selected SDT (7 Universities + NASA + International partners)
- Government Partners: NIST, NOAA
- UK NPL, Imperial College, NCEO
- WMO GSICS

IR Suite Overview

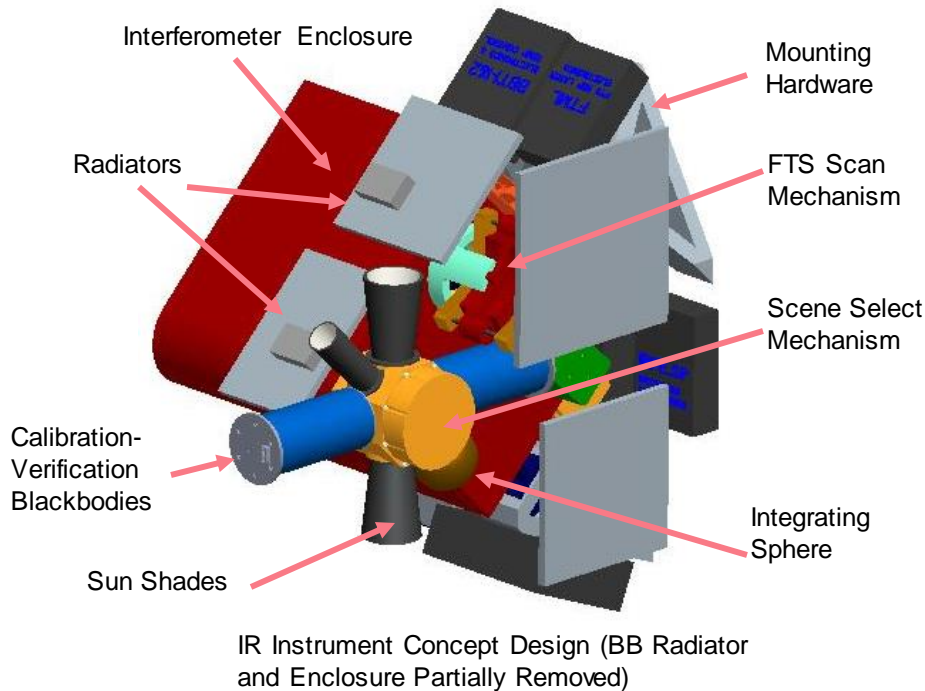

Instrument Description:

- A Fourier Transform Spectrometer (FTS) for SI traceable measurements of the Mid and Far-IR spectrum of the Earth and atmosphere
- Utilizes one ambient black body, one phase-change black body, and deep space as on-orbit calibration sources accessible with a scene select mechanism which is also utilized for spacecraft motion compensation
- Uncooled pyroelectric detector for the Far-IR
- Two-actively cryocooled HgCdTe (MCT) detectors for the Mid-IR

Characteristics:

- Radiance Scale Accuracy: $0.1 K 3\sigma$
- Spectral Range:
 - ~ 5-50 μm (200-2000 cm^{-1})
- Unapodized Resolution: 0.5 cm^{-1}
- Detectors:
 - MCT #1: ~3 to 9 μm (1111-3333 cm^{-1})
 - MCT #2: ~8 to 16.5 μm (606-1250 cm^{-1})
 - Pyroelectric: ~15 to 50 μm (200-667 cm^{-1})
- Footprint: ~25 km from 609 km
- Integration Period: ~ 8 seconds

NASA LaRC

5/12/2014



Reflected Solar Suite Overview

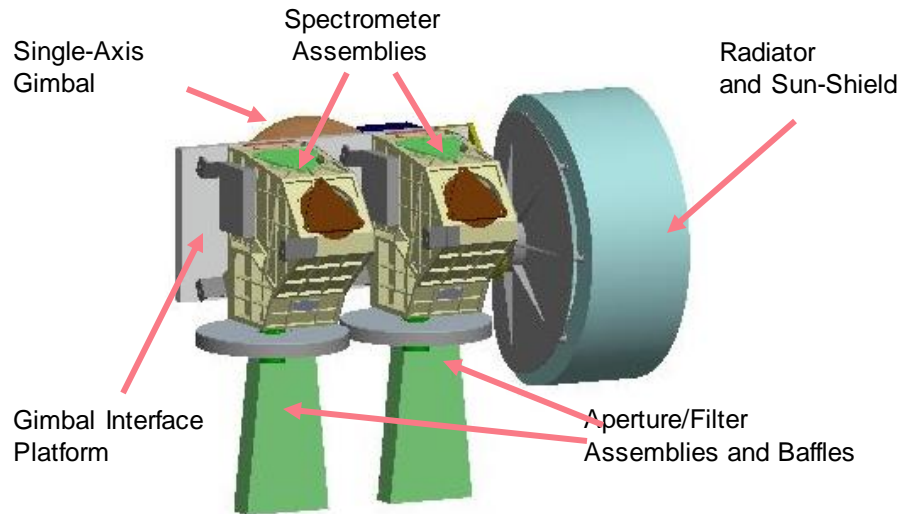

Reflected Solar Suite Design Concept

Baseline Instrument Package:

- *Two spectrometers, interface platform, filter assemblies, thermal management, and electronics*
 - Mass: ~70 kg
 - Average Power: ~96 W
- *Dimension: ~0.92x0.74x0.40 m³*
- *Data Rate: (with 2x compression)*
 - Solar Calibration: ~72 Mb/sec
 - Nadir Collection: <0.5 Mb/sec
- *Data Volume: (with 2x compression)*
 - Typical: ~66 Gb/day
 - Peak: ~69 Gb/day

Instrument Description:

- *A pair of pushbroom hyperspectral imagers with high spatial and spectral resolution*
- *Measures solar spectral reflectance of the Earth and its atmosphere relative to the solar irradiance spectrum*
- *Calibration of detectors obtained through precision apertures, neutral density filters, and perforated plates rotated via filter wheels*
- *Field of regard (FOR) achieved with combination of spacecraft bus motion and single-axis gimbal*

Characteristics:

- *Absolute reflectance measurement uncertainty of 0.3% at 2 σ confidence for the total integrated broadband reflected solar spectrum*
- *Polarization sensitivity <0.25% below 1000 nm and <0.75% at other wavelengths*
- *Spectral Range: 320 – 2300 nm*
 - ~320 to ~640 nm (“Blue”)
 - ~600 to ~2300 nm (“Red-NIR”)
- *Spectral Sampling: ~2 – 4 nm*
- *Swath Width: >100 km cross-track from 609 km*
- *Spatial Sampling: ~0.5 km at Nadir*



Single-Axis Gimbal Overview

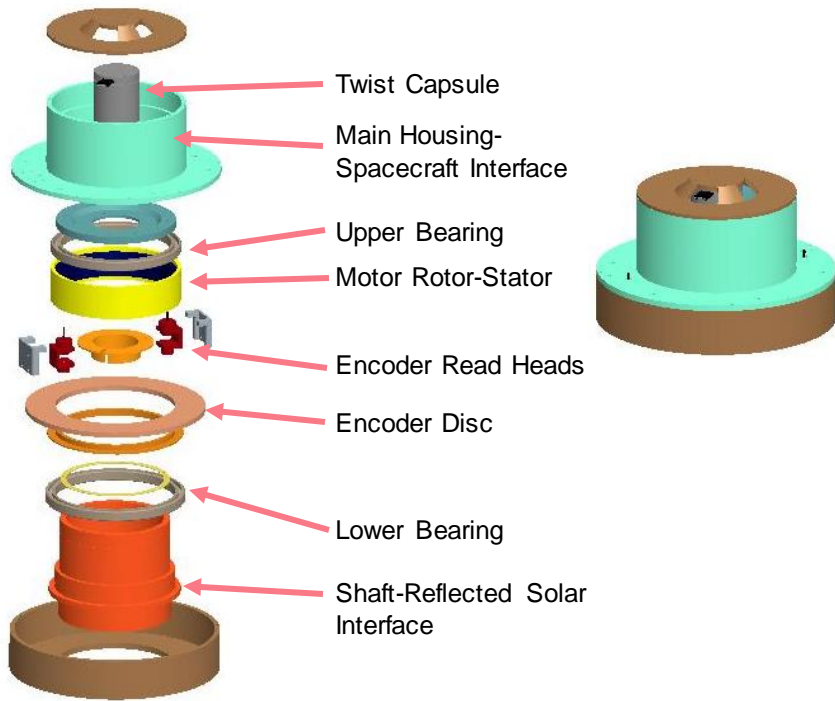

Single-Axis Gimbal Design Concept

Baseline Concept:

- *Gimbal, electronics, and cabling*
 - Mass: ~14 kg
 - Average Power: ~17 W
 - Peak Power: ~55 W
- *Dimension: ~0.2m x 0.3m diameter*
- *Data Rate: ~3.3 kb/sec*
- *Data Volume: ~280 Mb/day*

Description:

- *Provides cross-track pointing required by reflected solar suite for on-orbit calibration-verifications, reference intercalibrations, and benchmarking (nadir-collection) without additional optics*
- *Provides mechanical and electrical interfaces between the spacecraft bus and the reflected solar suite*
- *High-TRL components and similar gimbals have flight heritage*
- *Optical encoder provides shaft angle for closed-loop control and motor commutation*
- *Brushless DC motor provides zero-cogging and smooth drive torque*
- *Twist capsule used to carry gimbal and reflected solar signals and power across rotating interface*

Characteristics:

- *Range of Motion: +/- 180 degrees*
- *Angular Knowledge: < 20 arcsec*
- *Angular Control: < 72 arcsec*
- *Slew Rates: > 5 deg/sec*
- *Tracking Rates: Up to 5 deg/sec*
- *Acceleration: ≥ 1 deg/sec²*





CLARREO Pathfinder

Reflected Solar (RS) Spectrometer Description

- Previously developed by LASP under NASA Earth Science Technology Office (ESTO) Instrument Incubator Program (IIP)
- **Push-broom Spectrometer**
 - 350-2300 nm spectral range
 - 70km cross-track swath width
 - Previously demonstrated to achieve accuracies approaching CLARREO requirements for climate data records
- Pointing System enables solar / lunar viewing
 - 2-axis brushless gimbal
 - Star tracker
 - Inertial Measurement Unit

Instrument has been previously flown on two high altitude balloon flights

Vacuum Door Mechanism

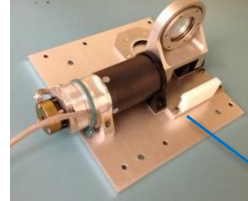

Filter Wheel and Aperture Mechanisms

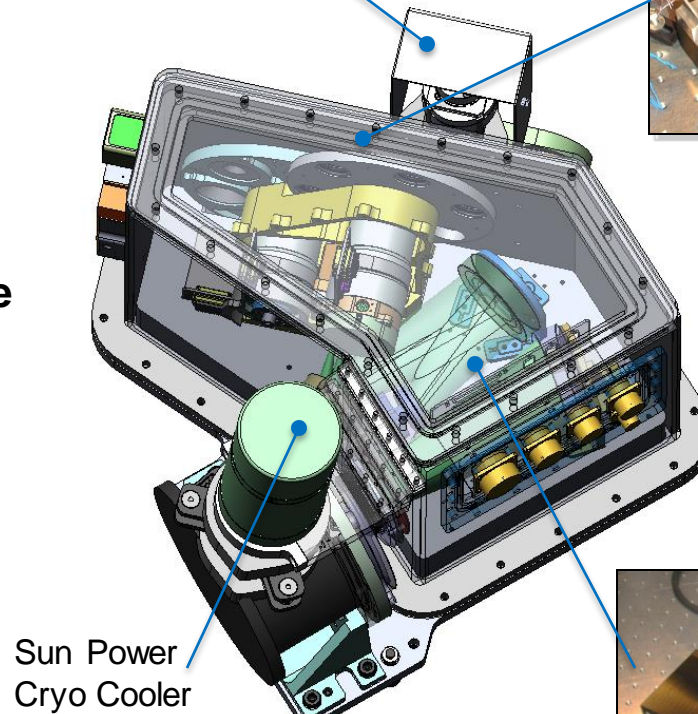
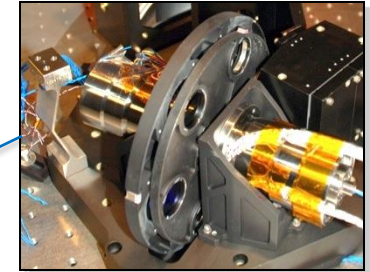

Sun Power Cryo Cooler

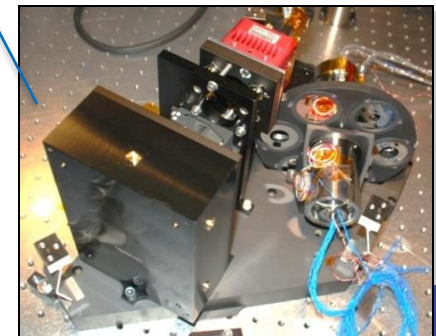

Pointing System Expanded View

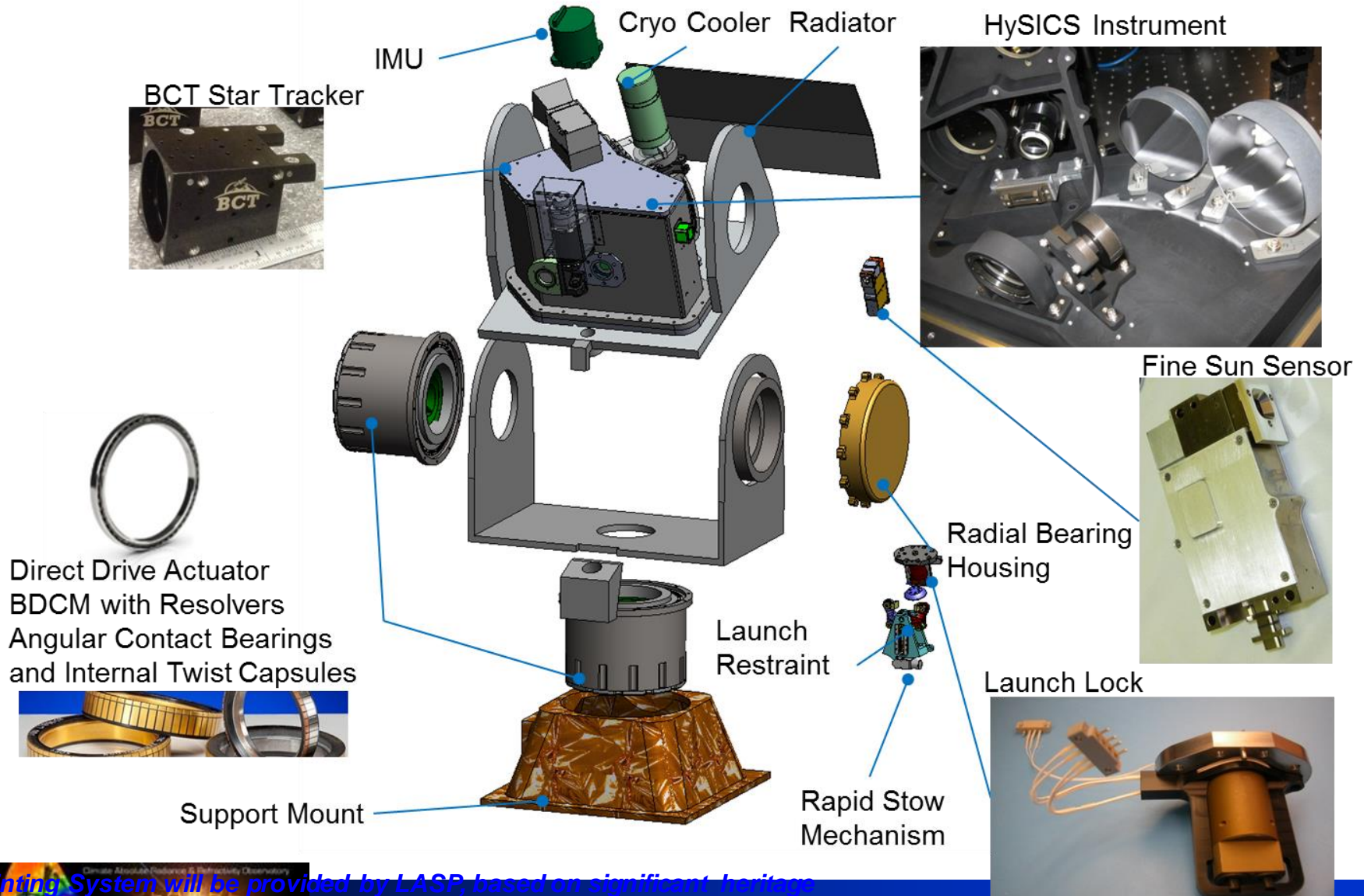

Pointing System will be provided by LASP, based on significant heritage from LASP-developed pointing systems for TIMED, Glory, and TSIS

