



Evaluation of Additively Manufactured Metals for Use on Oxygen Systems

Presented By: Jonathan Tylka
NASA Johnson Space Center
White Sands Test Facility



Aerospace Fire History

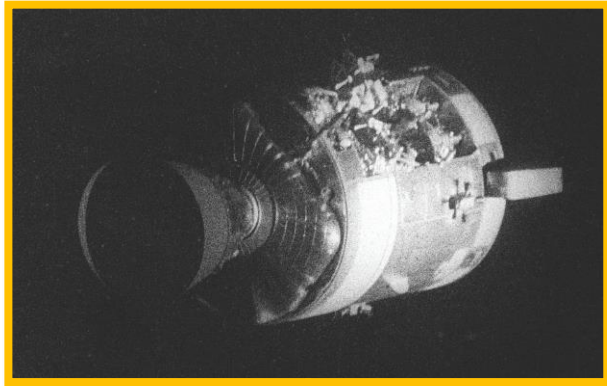

1965	1970	1975	1985	1995	2005	2015
Apollo 1 1/27/1967	Apollo 13 4/14/1970	The EMU Fire 9/15/1980		MIR Fire 2/24/1997		Cygnus CRS Orb-3 10/28/2014



Oxygen Compatibility

- Additive Manufacturing (AM) has been, and will continue to be, used in oxygen systems
 - Compatibility studies are a necessity
 - Risks if not pursued
 - Equipment Damage, Loss of Mission, Loss of Life
 - NASA Centers of Excellence leading efforts
 - White Sands Test Facility (WSTF)
 - Oxygen Compatibility Testing
 - Marshall Space Flight Center (MSFC)
 - Additive Manufacturing
 - NASA Engineering Safety Center (NESC)
 - Statistical Design of Experiments
-



We must manage the risks...

Maximize more compatible materials

- Ignition resistant
- Burn resistant
- Low damage potential

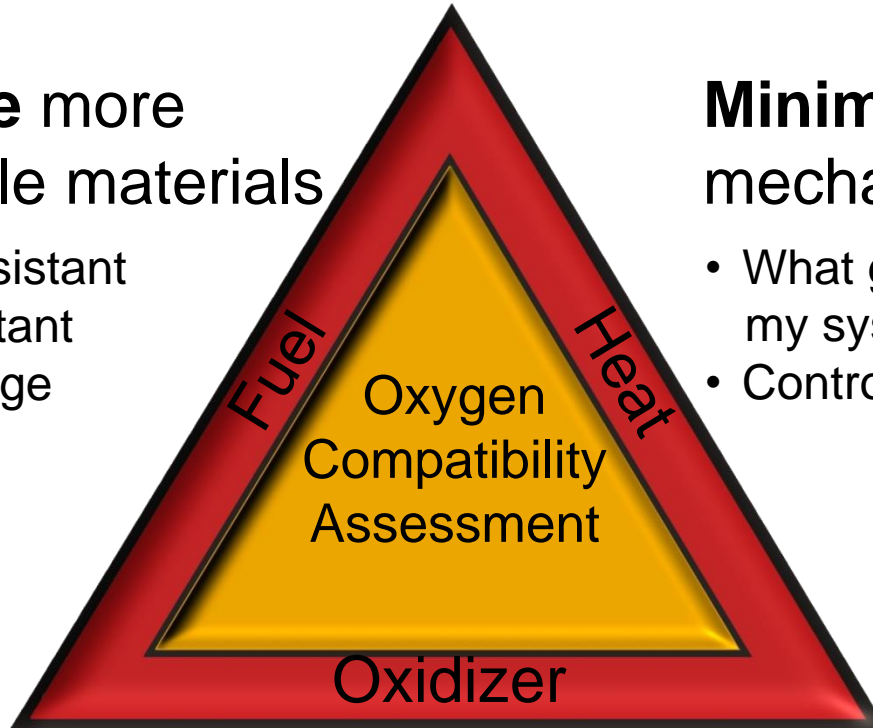

Minimize ignition mechanisms

- What generates heat in my system?
- Control or eliminate

Utilize good practices

- Implement all aspects of oxygen system safety



Maximize

- Testing determines AM flammability performance
- NASA-STD-6001B Test 17/ ASTM G124
 - Upward flammability test
 - 1/8-in. diameter x 6-in. long
 - Unheated
 - Static Pressure
 - >99.5% Oxygen
 - Magnesium/Pyrofuse Promoter

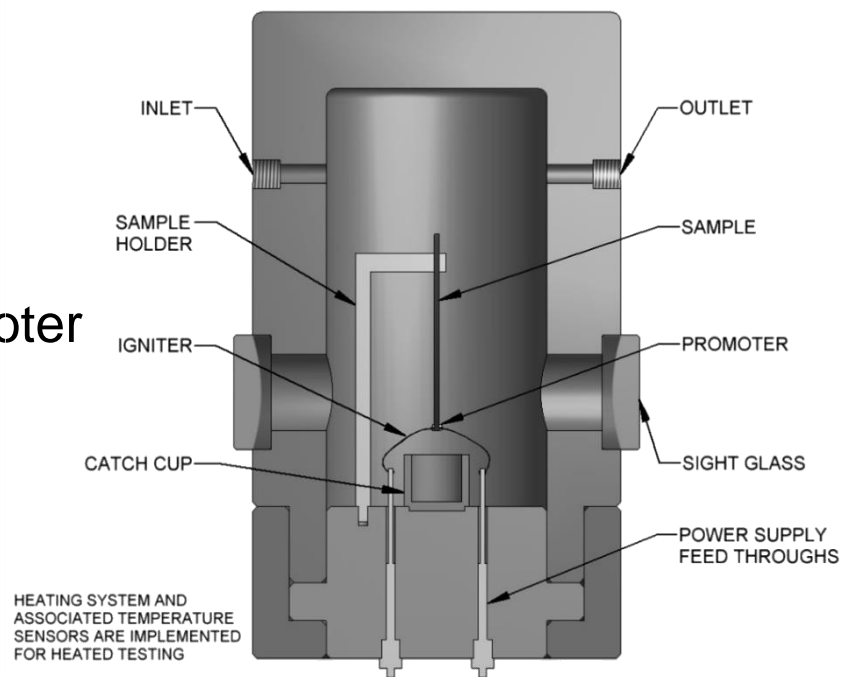



Preliminary Flammability Testing

- Experiment conducted between:
 - Wrought Inconel 718
 - Selective Laser Melting (SLM) Inconel 718 (IN718)
- Statistically designed, efficient, and randomized
- Test specimens manufactured at MSFC
- Material flammability differences noted
 - Result statistically significant but counterintuitive
- SLM IN718 post-build processes need investigation
 - Stress relief (SR)
 - Hot isostatic pressing (HIP)
 - Solutionizing and aging heat treatments (HT)



Preliminary Flammability Results



Printed, HT, no HIP

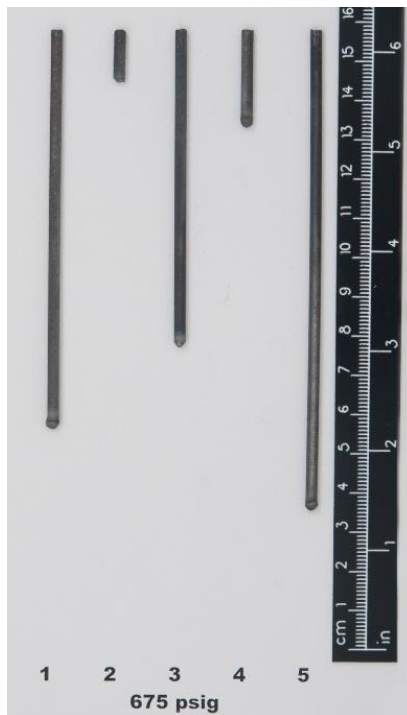

Printed, HIP, and HT



Wrought and HT

- SLM IN718 with/without HIP vs Wrought
- All materials had AMS 5664 HT



Various Nb Precipitate Formation

As-Printed/HT

HIP/HT

Wrought/HT

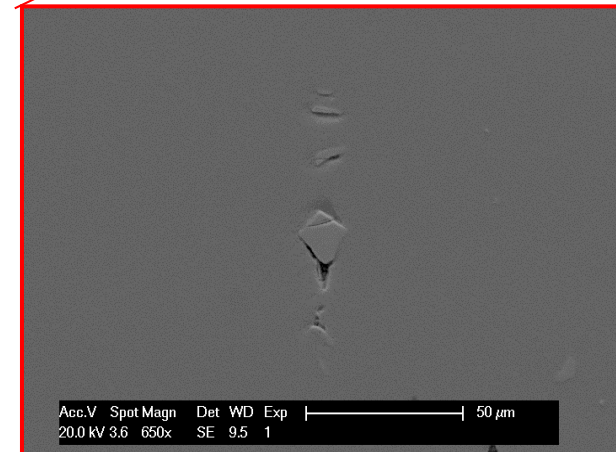
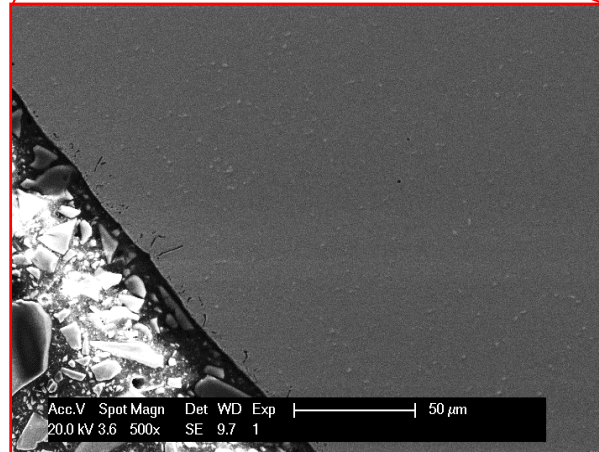
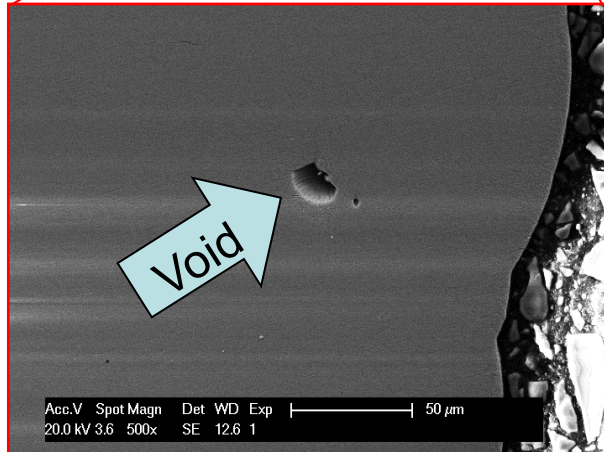
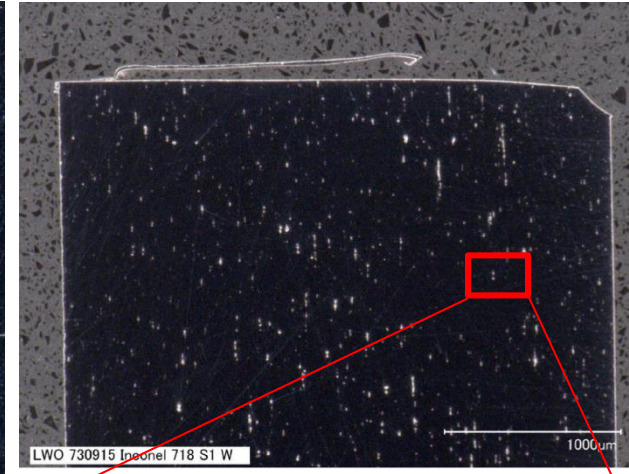
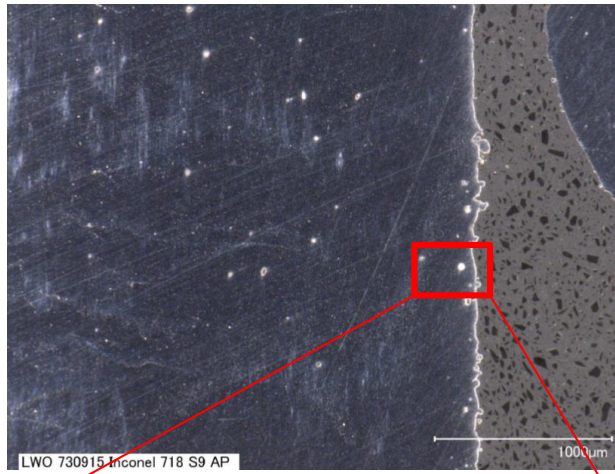



Axial Burning Interface of HIP Sample

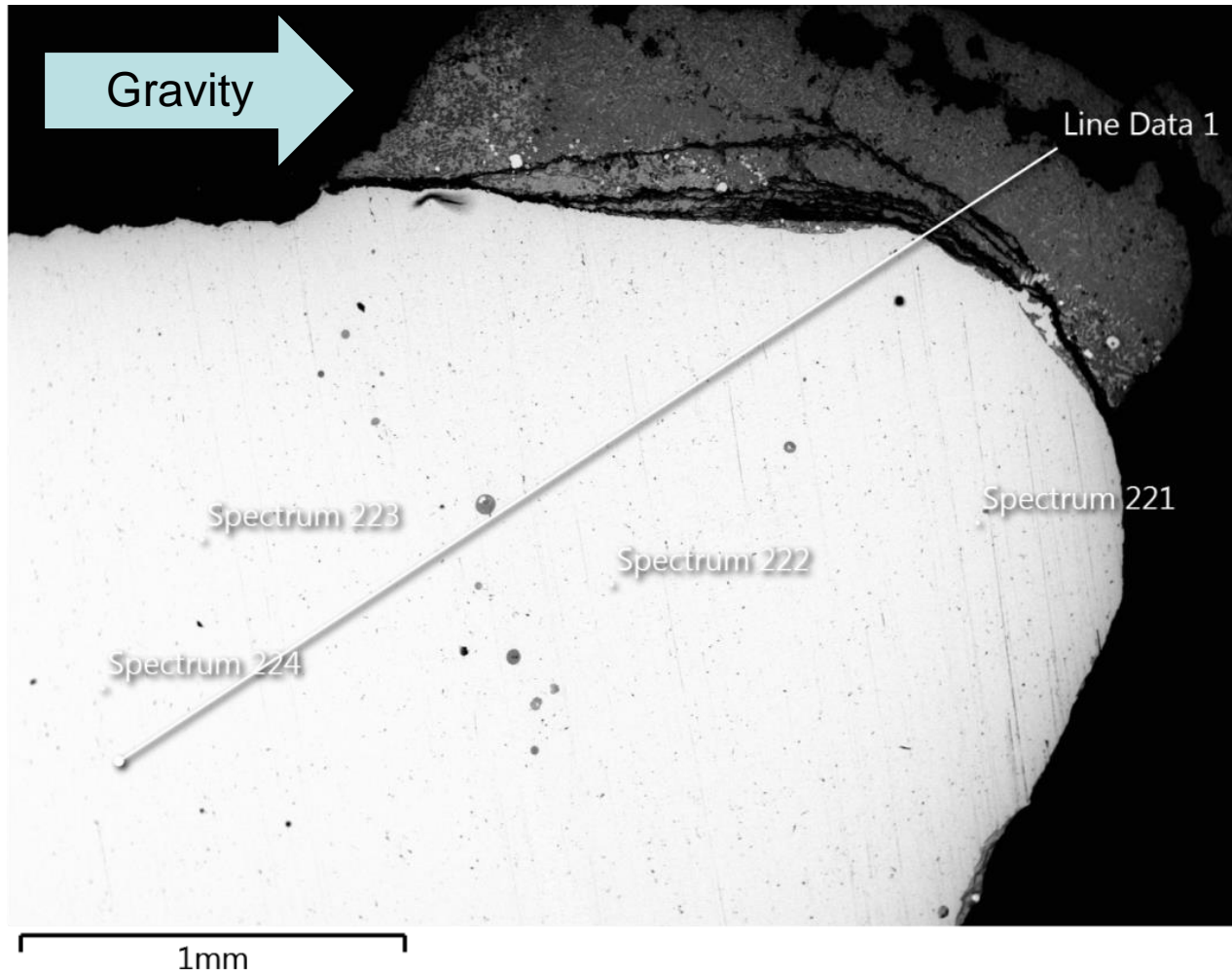



Composite Energy-Dispersive Spectroscopy (EDS)

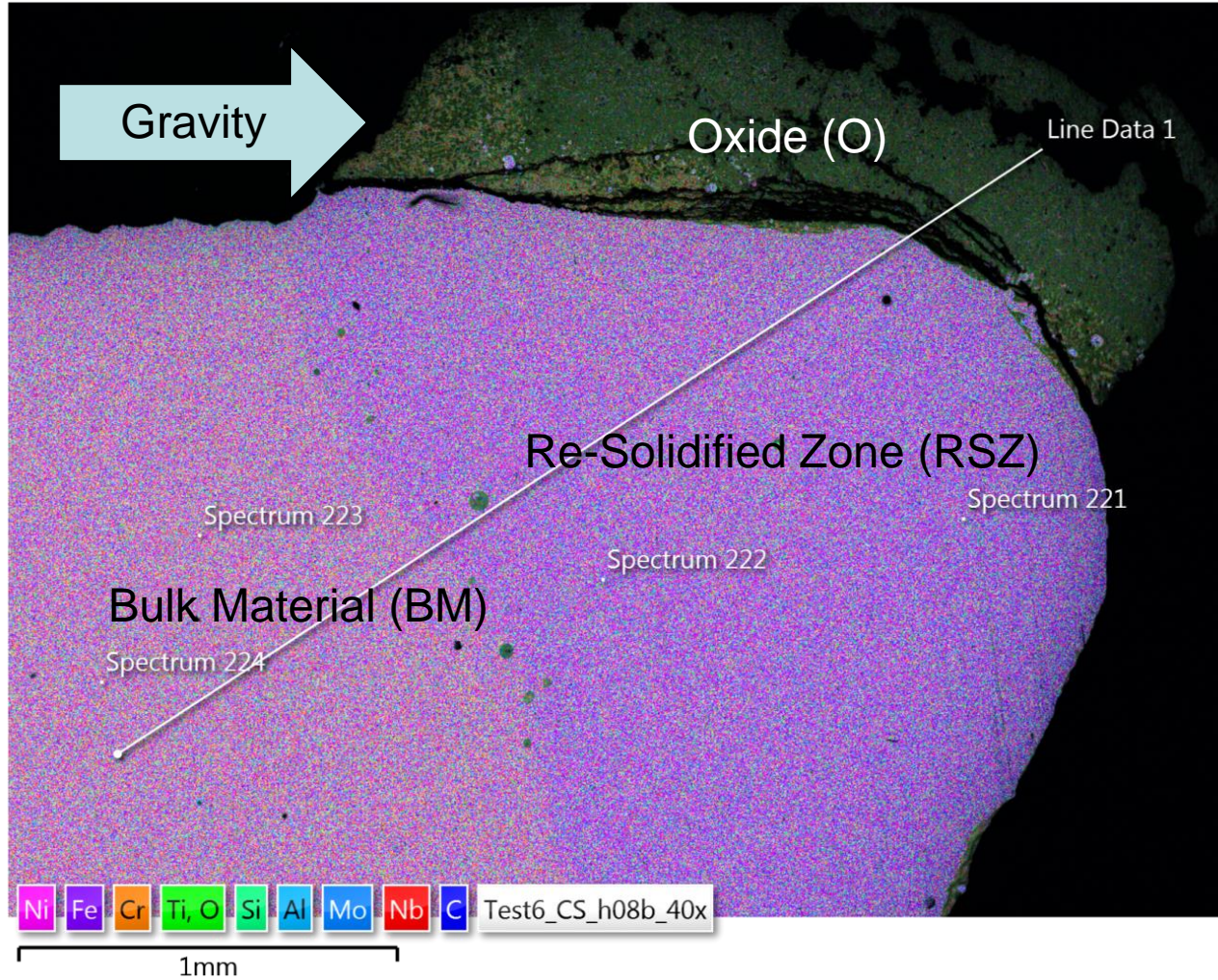



EDS Mapping of Individual Elements

Reference Image

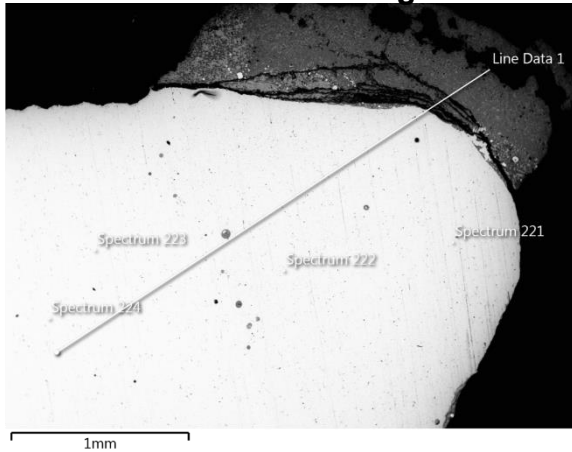

Ni K series

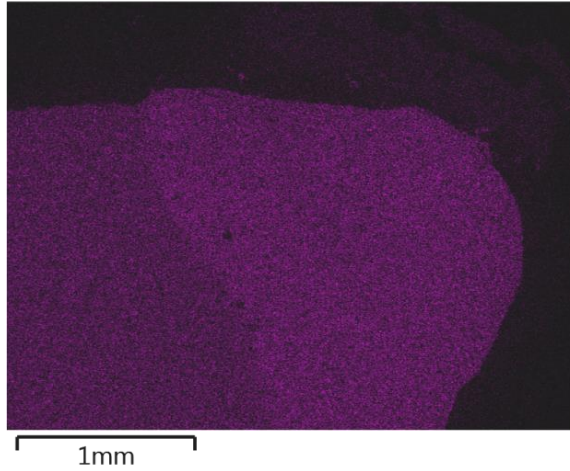

O K series

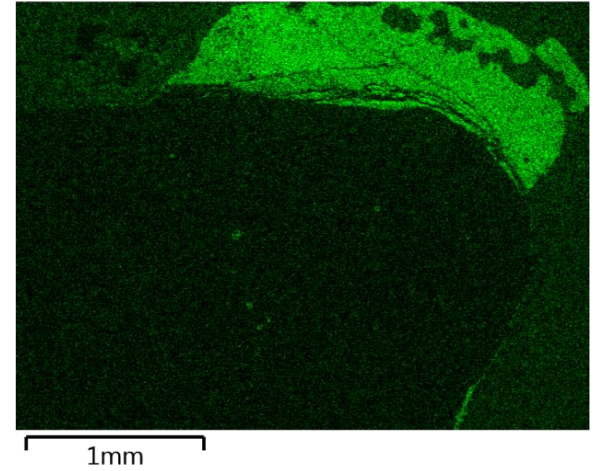

Nb L series

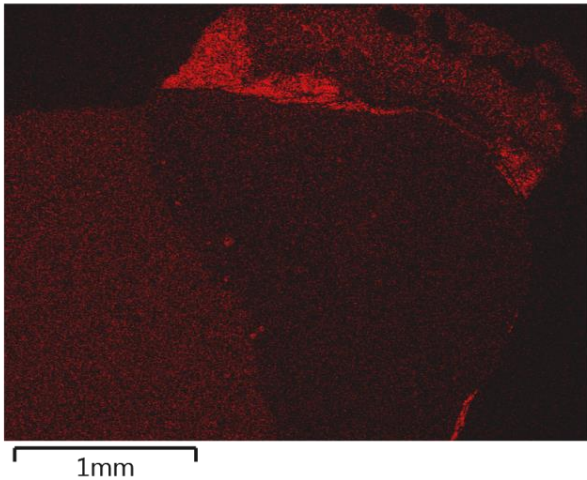

Ti K series

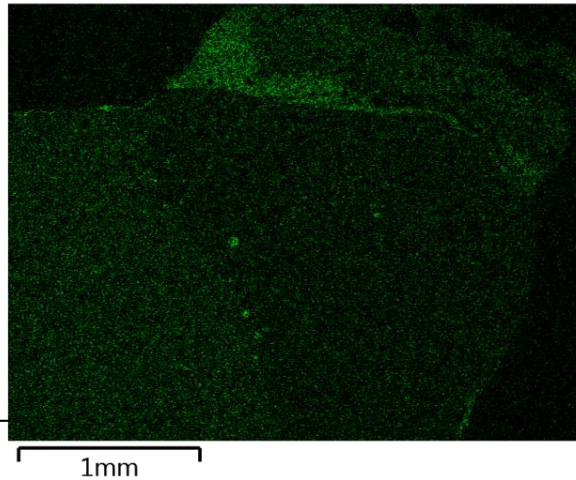

Al K series

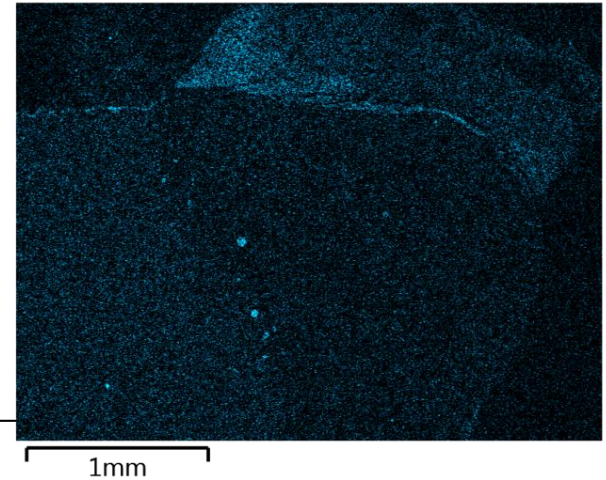



EDS Mapping of Individual Elements

Reference Image

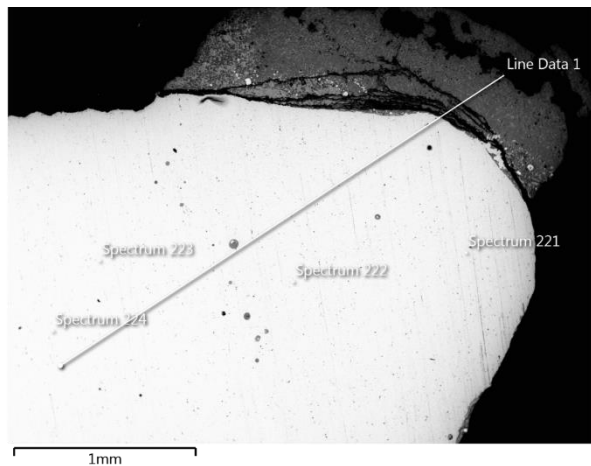

Cr K series

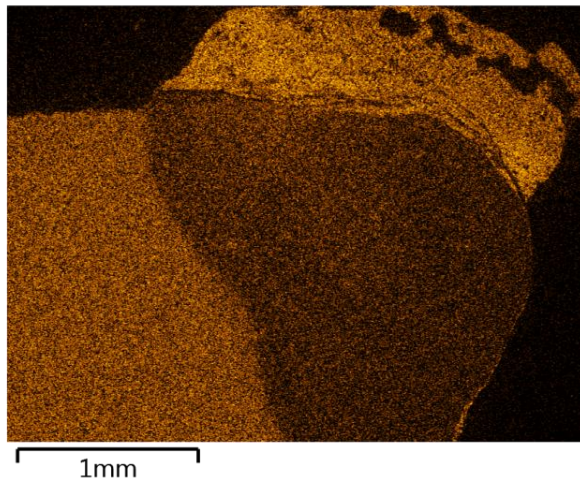

Fe K series

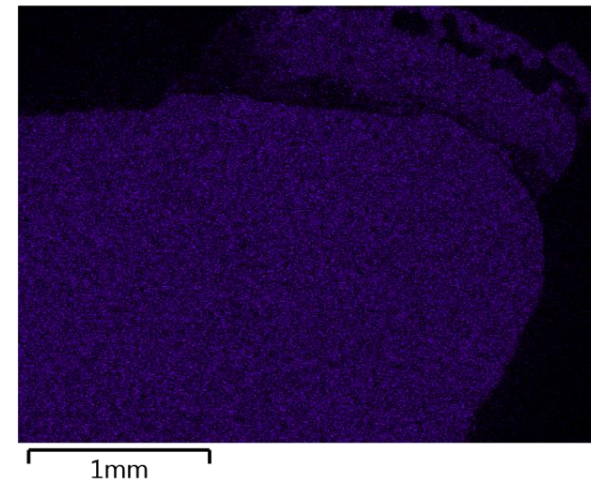

- Scavenging of flammable constituents in RSZ
 - Cr, Al, Ti, Nb
- Concentration of non/less flammable constituents in RSZ
 - Ni
- Fe remained distributed in BM, RSZ, and O Zones



Flammability Study - Ongoing

- SLM IN718
- Replicate and expand experiment
- Print parts in same build
- Synchronously SR and HT
- Factors
 - HIP (with/without)
 - Effect of HIP temperature excursion
 - Performed in vacuum furnace
 - Furnace cool vs. quench
 - AMS 5664 HT (with/without)
 - Location on build plate

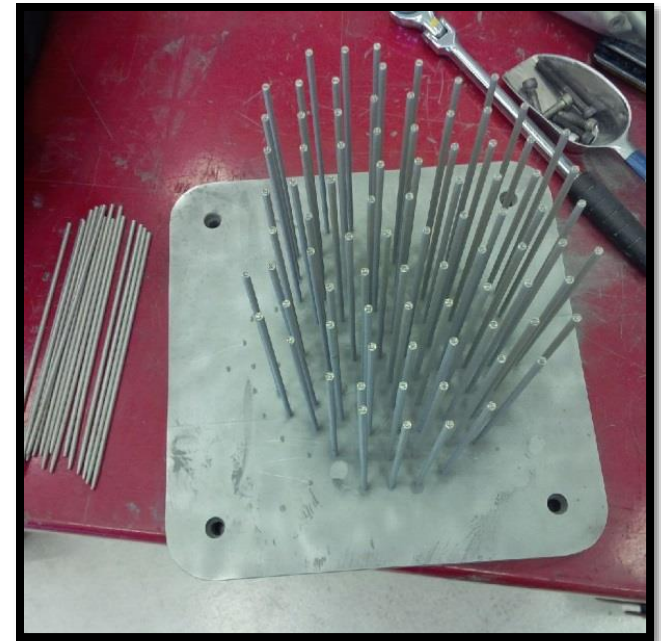



Minimize

- Particle Impact
 - Most common direct igniter of metals
 - Hazards increase with:
 - Pressure, temperature, velocity, flammable particles
 - SLM Components shed metal particles (Lowrey 2016)

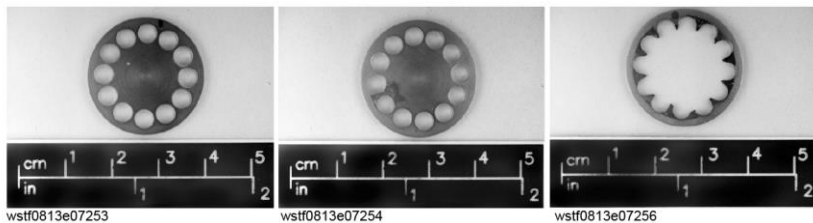
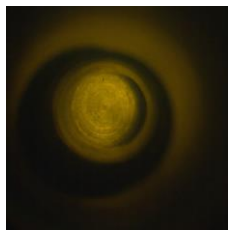
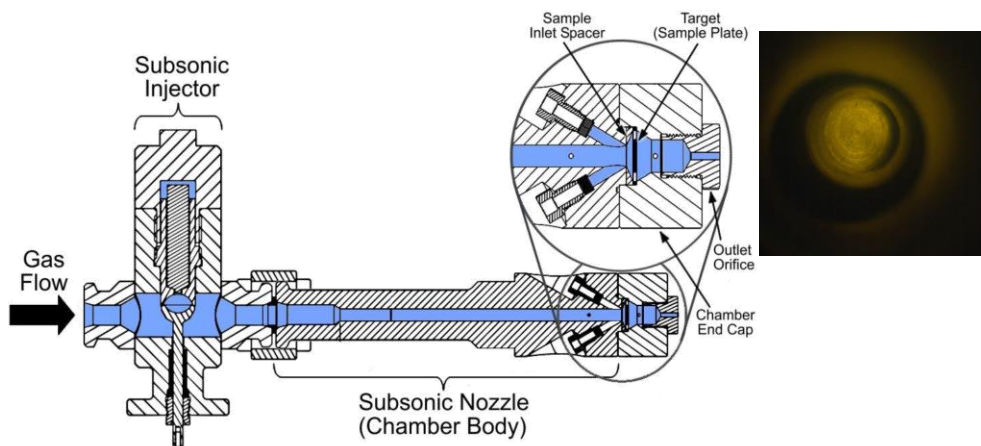

wstf0813e07253

wstf0813e07254

wstf0813e07256

Subsonic

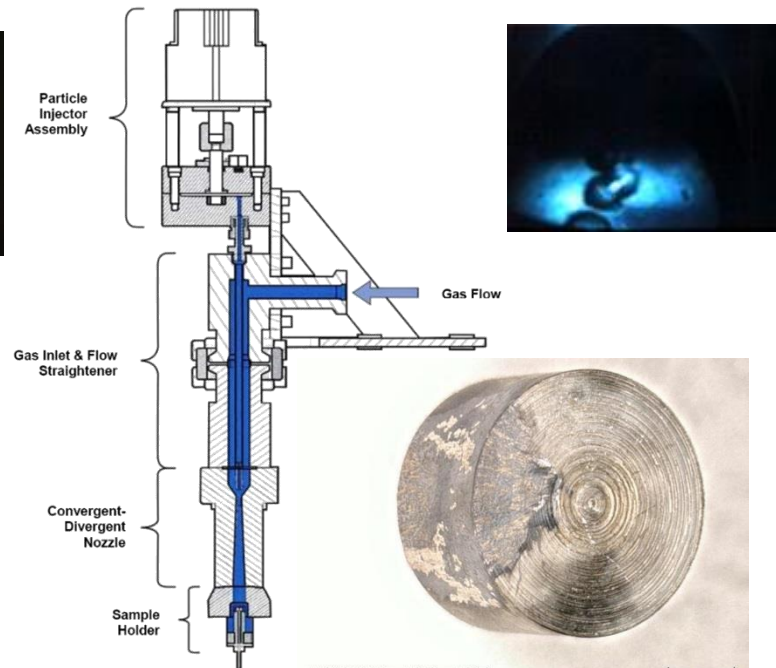

LWO 731416 Monel 405 Sample 33

2500µm

Supersonic



Planned Ignition Study

- Subsonic & Supersonic Impacts on SLM IN718
 - Pressures, temperatures, velocities
- Study effect of AM characteristics on ignition sensitivity
- Factors
 - Print direction
 - Surface treatment
 - Post-manufacturing processes (pending flammability results)
 - Particle types

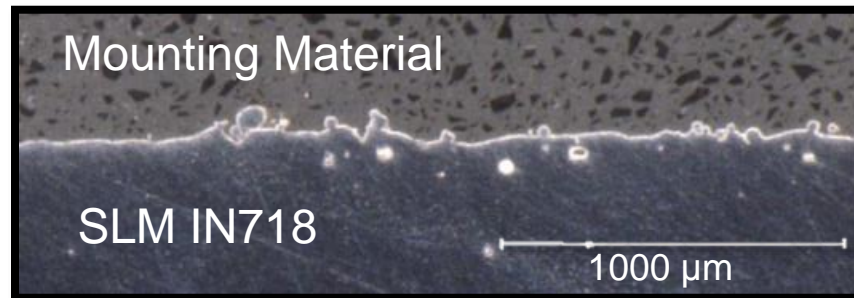



Utilize

- AM production
 - Dedicated machine(s) for each material
- Precision cleaning
- AM component/system design recommendations
- Assembly
- Operations
- Maintenance





Long-Term Goals

- Draw additional commercial and government partners
- Test full-scale AM components
- Develop guide for the use of AM in oxygen systems
 - Design
 - Manufacturing
 - Cleaning
 - Assembly
 - Operations
 - Maintenance





Acknowledgements

- WSTF
 - Steven Peralta
 - Kyle Sparks
 - Steven Mathe
 - Paul Spencer
 - Mika Meyers
 - Ilse Alcantara
 - Susana Harper
 - Fred Juarez
 - Steven Bailey
- MSFC
 - Ken Cooper
 - Brian West
 - Arthur Brown
 - Nikki Lowrey
 - Mark Mitchell
 - Kevin Edwards
- NESCC
 - Ken Johnson