

# LARGE-SCALE V/STOL EXPERIMENTAL INVESTIGATIONS OF AN EJECTOR-LIFT FIGHTER AND A TWIN TILT-NACELLE TRANSPORT

AIAA 2016 INTERNATIONAL POWERED LIFT CONFERENCE  
SEPTEMBER 27-29, 2016

Michael Dudley, NASA Aeronautics Research Institute



## Overview of the large-scale experimental investigations conducted in the NASA Full-Scale Aerodynamics Complex (NFAC) for two Powered Lift Vertical/Short Takeoff and Landing (V/STOL) concepts in the 1980s

- Ejector/Thrust Deflecting STOVL fighter (E-7A, late 1980s)
- Twin-tilt Nacelle Subsonic V/STOL light transport (Grumman Aircraft Company Design 698 [GAC-698], early 1980s)

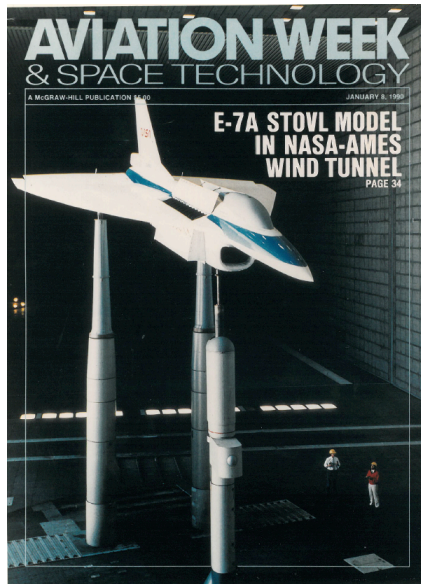

# Ejector/Thrust Deflecting STOVL fighter: E-7A

**NASA, DARPA, the Canadian Government (DIST), and Industry conducted an aircraft development program in the late 1980s in response to increasing US/UK interest in supersonic V/STOL fighters.**

**The objective was to design an aircraft that could replace most existing close air support/air combat fighters (A7, A10, AV-8, F16, F18) with a single aircraft that had some of the qualities of an air superiority fighter (F15, F22) and the deployment flexibility of an AV-8 Harrier.**

**Technical challenges included minimizing:**

- **Engine stall producing hot gas ingestion**
- **Lift system volume for supersonic capability**
- **Jet impingement ground erosion**



DARPA: Defense Advanced Research Projects Agency  
DIST: Department of Industry Science and Technology

Industry: General Dynamics and Boeing/Dehavilland  
V/STOL: Vertical/Short Take Off and Landing

# E7-A Design Concept

## Fuselage ejector lift augmentation system combined with vectoring-ventral and aft-cruise nozzles

- Fuselage Ejector
  - Augments fan thrust by 55% (1.55 augmentation ratio)
  - Cool exhaust shields inlet from ventral nozzle hot gas
  - Outer panels fold to conform to fuselage shape
  - Benign forward ground impingement
- Ventral nozzle
  - Vectors to provide axial thrust needed to overcome ejector ram drag during transition
  - Provides 50% of hover lift

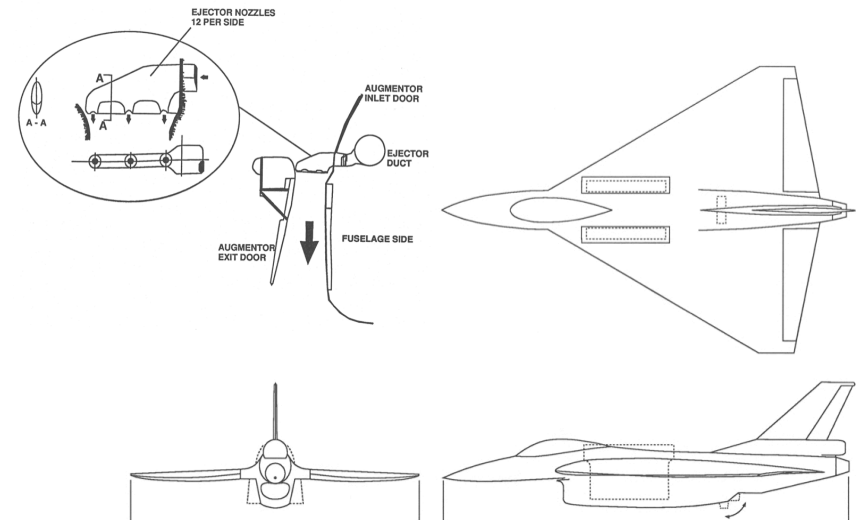
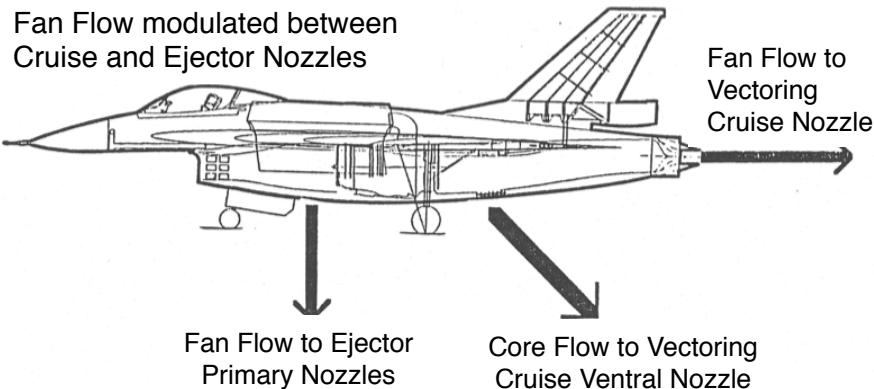
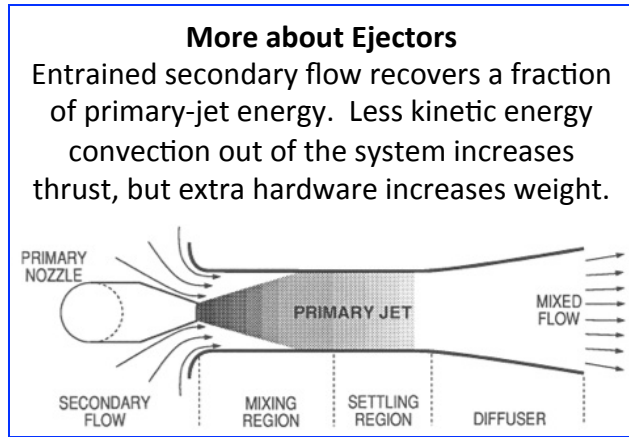

# E7-A Design Issues

**After over 20 years (1960s – 1990s) Ejector design was still more art than science**

**Augmentation levels ( $\text{Thrust}_{\text{ejector}}/\text{Thrust}_{\text{primary-jet}}$ ) in excess of 1.7 were achieved in isolated systems, but---**

- Obtained through subtle changes in duct & nozzle geometries
  - Ejector designs matured by cut and try test efforts of two very skilled Dehavilland engineer craftsmen (artisans)
  - Minor geometry and installation modification often resulted in unanticipated significant performance loss
- Experimental and CFD data predictions were inconsistent
  - Unanticipated experimental results going from small to large scale
  - The most advanced supercomputers available not adequate to optimize 3-D turbulent mixing flow ejector designs
    - Cray-2 roughly equivalent to an iPad-2
      - 4 GB core, 1.5 Gflop processors



Program unable to establish confidence that modeled systems could be evolved into flight systems in a predictable manner

# E7-A and F-35B V/STOL Design Approaches

The F-35B Lightning II Joint Strike Fighter (JSF) also employs an aft vectoring nozzle but uses a shaft driven fan to balance lift and reduce hot gas ingestion

- **Lift fans are heavier and mechanically more complex than storable fuselage ejectors, however:**
  - Fan design tools and methods were more mature
  - Reliable CFD turbo-machinery design codes were available
  - Mechanical systems behavior was more predictable than pneumatic systems dependent on precise management of turbulent mixing flows

**JSF development risk deemed lower for a lift-fan than ejectors**

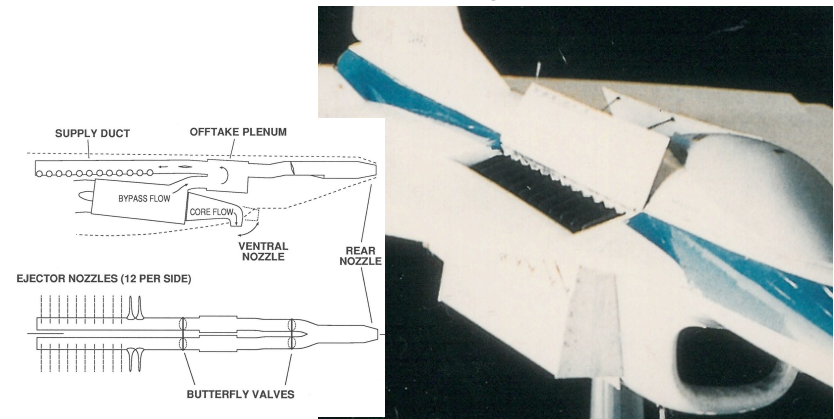
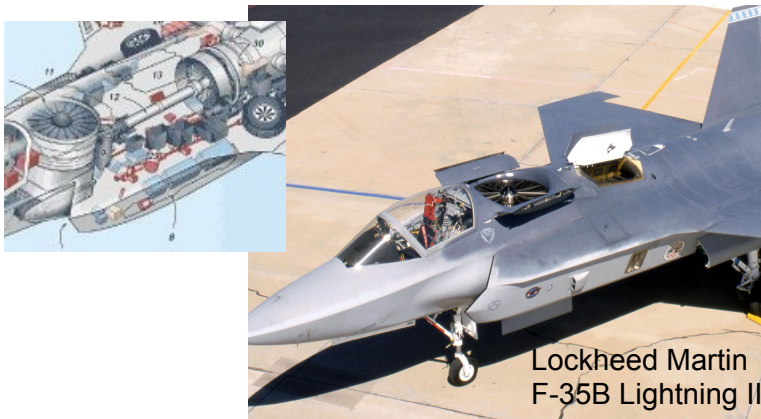

# Twin-tilt Nacelle V/STOL Light Transport

In the early 1980s Grumman Aircraft Company proposed a Twin Tilt-nacelle Vertical/Short Take Off and Landing (V/STOL) Light Transport in response to the USN “Type A V/STOL” subsonic utility aircraft requirement, and later competed in the Joint-service Vertical Takeoff/Landing Experimental (JVX) Aircraft Program.

The JVX program objective was to identify a V/STOL aircraft that could be used by all military services and have speed, range, and reliability performance superior to conventional rotorcraft.

The GAC Design 698 was one of the three finalists, but the V-22 Osprey won the competition primarily due to its lower disk-loading and longer hover capability needed to satisfy Air/Sea Rescue and Special Operations troop deployment requirements.

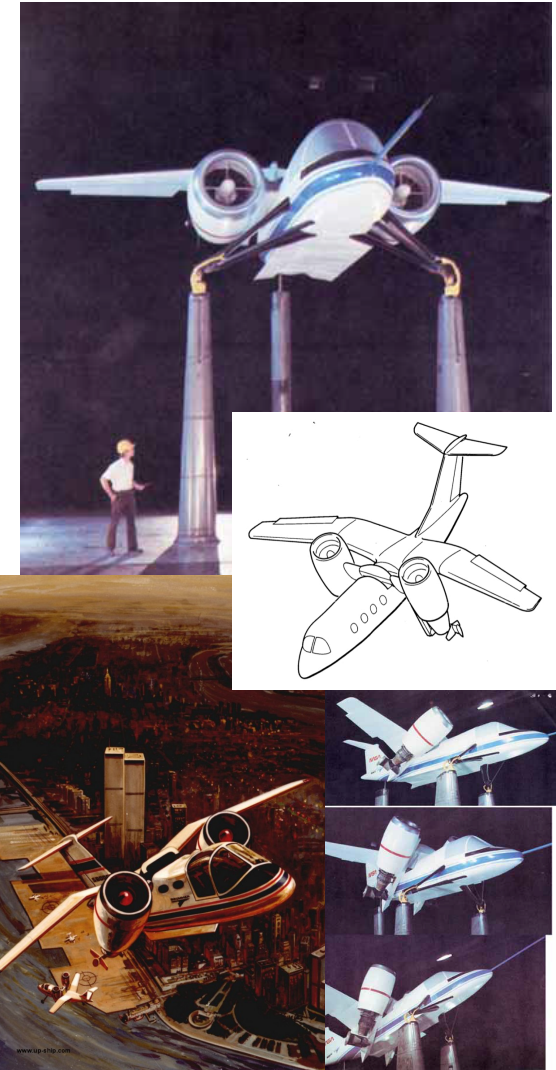

# Twin Tilt-nacelle/Tilt-rotor Comparison



Max Speed (M)  
Cruise Speed (M)  
Range (naut. mi.)  
Service ceiling (ft.)  
Rate of climb (ft./min)  
Disc loading (lb./ft<sup>2</sup>)  
Hover loiter time

**0.49 (305 kts @ 15K ft)**  
**0.37 (241 kts @ SL)**  
**879**  
**25,000**  
**2,320 – 4000**  
**20.9**  
**extended**

Demonstrated Performance  
Max V-GTOW 52,600 lbs.

**0.80 (459 kts @ 36K ft)**  
**0.59 (339 kts @ 36K ft)**  
**1410**  
**50,000**  
**12,200**  
**1330**  
**5 min**

Predicted Performance  
Max V-GTOW 45,000 lbs.



# Twin Tilt-nacelle Concept

**Conventional turbofan engines rotate vertical for takeoff and hover flight, horizontal for cruise.**

**Control vanes immersed in jet exhaust to vector thrust for control in hover.**

**Wing borne flight performance comparable to conventional subsonic jet aircraft.**

**Engine cross-shaft mitigates loss-of-engine conditions.**

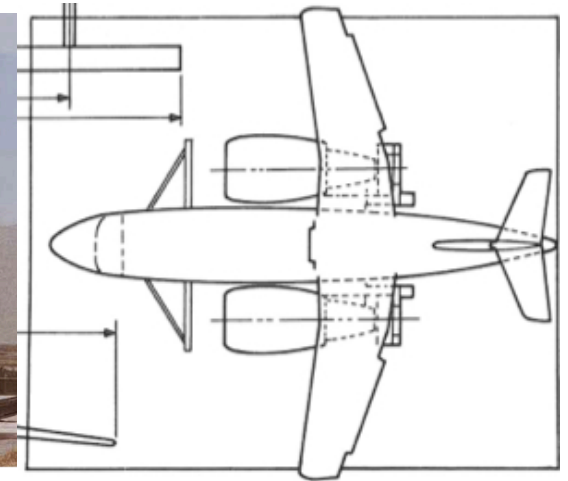
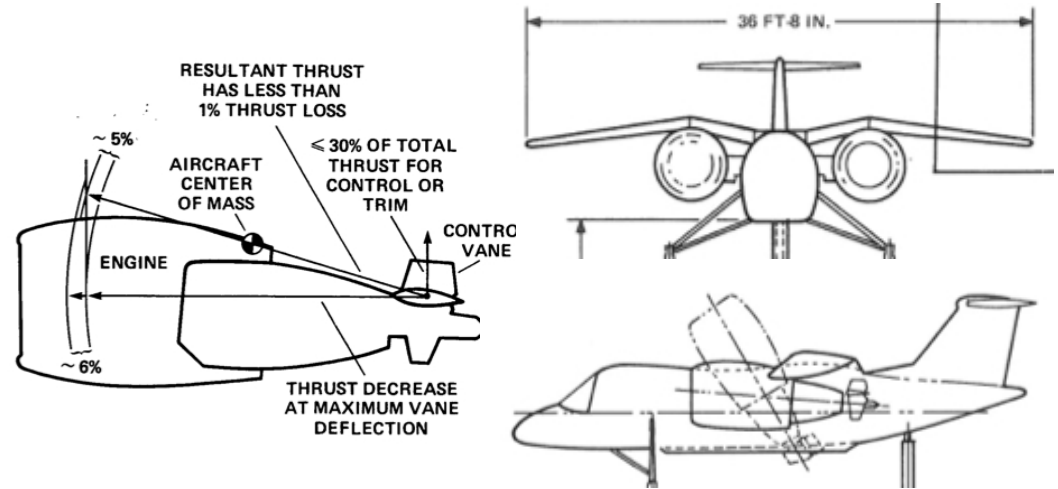

## Opportunities for improvement

- Cross-shafting penalties (required for single engine ops)
  - Catastrophic aircraft loss without balanced hover thrust
  - Fairing creates undesirable drag and pitching moments
  - Additional weight and mechanical complexity
- Weight and drag penalty for long inlets used to minimize hot gas ingestion and control inlet separation distortion
- Thrust vectoring control vanes decrease thrust by 1% and control effectiveness deteriorates at deflections above  $15^\circ$
- Limited hover capability due to high disk loading

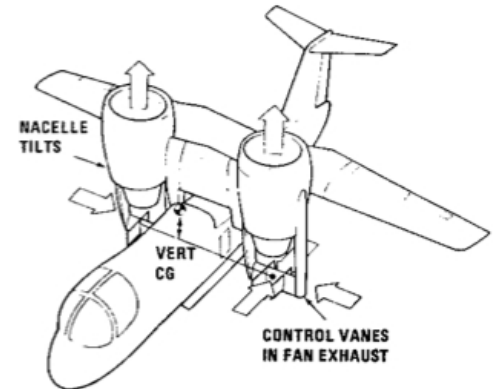

## Potential solutions to consider

- Multi-engine per side to eliminate X-Shaft
  - Distributed electric propulsion (DEP)?
- Shorten inlet with advance CFD and DEP designs
- Thrust vectoring nozzles for less control drag
- Civilian missions without extended hover requirements



## Things change, and failure to recognize change quickly can be fatal.

- Modern aircraft design cycles can take decades so it is important to be aware of trends in factors that influence a concept's viability:
  - Technology breakthroughs
  - Changes in mission priorities
  - Economic drivers
  - Markets
  - Environments
    - Political
    - Regulatory
    - Physical
    - Social
- Changes in these factors will influence mission requirements, the means of meeting requirements, and ultimately the potential for the design to succeed

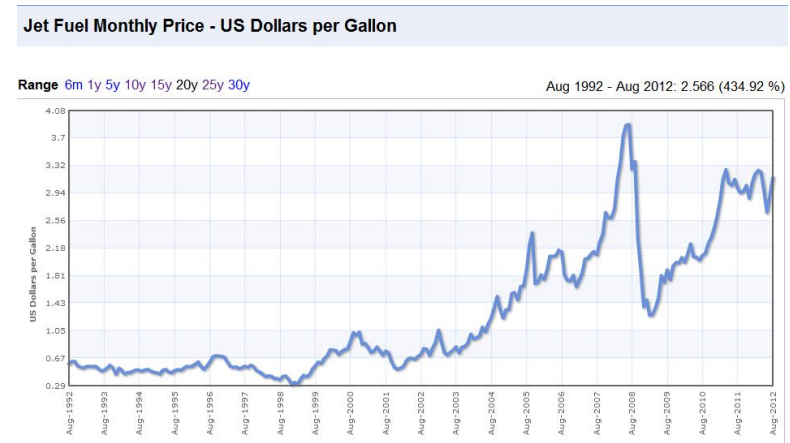

[www.airportwatch.org.uk](http://www.airportwatch.org.uk)

# Some Lessons Learned

## Design tools are not always up to the task

- Mature design tools and methods are often not available for novel concepts
  - There is not an imperative to create design tools for novel systems where no previous need has existed (chicken and egg situation)
  - Adaptation of tools and methods from other fields (multi-discipline cross-fertilization) can break the cycle
- The viability of a design can change as tools, methods, and technologies evolve
- Decisions to continue an aircraft's development are based in part on perceived risk
  - Which is a function of the confidence in currently available tools

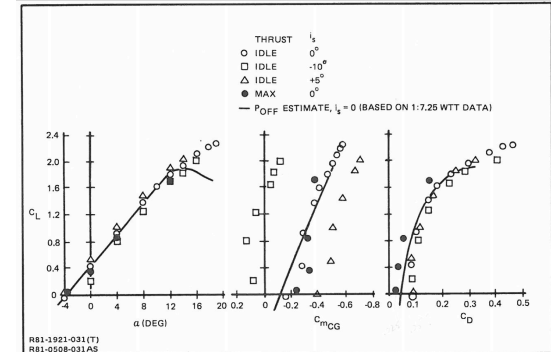

Figure 2-9. Aero characteristics,  $\beta_{NAC} = 5$  deg, direct power removed.

NASA/GAC  
Wind Tunnel Data  
Circa 1980

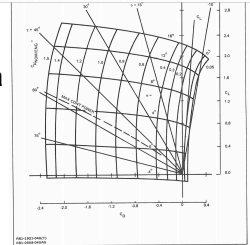
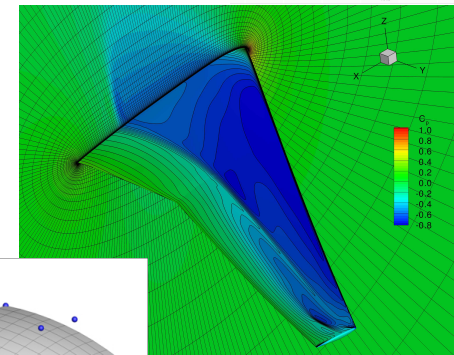

Figure 2-18. Force effect on inverted airfoil.  $\beta_{NAC} = 5$  deg.



NASA/Univ. of Michigan  
MDO Analysis  
Circa 2016

## Emerging technologies offer potential opportunities for addressing some of the challenges faced by abandoned aircraft concepts

- Apply advanced CFD multi-disciplinary design optimization methods
  - Optimize V/STOL ejectors lift systems with high fidelity 3-D turbulent mixing/entrainment models
  - Compact lightweight tilt-nacelles
    - Shorter separation resistant inlets
- Hybrid distributed electric propulsion
  - Multi-tilt-fan per side
    - Eliminate cross-shaft requirement
    - No hot gas ingestion
- Tilt-nacelle vectoring nozzles
  - Eliminate control vane drag thrust loss
- New Applications
  - Unmanned Aerial Systems
  - Civil V/STOL transport

