

TriTech Small Business Development Center Presentations

Authored by:

Laura Fobel, Mark Davis, Janeya Griffin,
Jerry Budd, John Del Frate, Hon (Patrick)
Chan

Approved TN 37239





Fiber Optic Sensing System (FOSS)

Technology Rodeo II

Corona, CA

November 10th, 2016



National Aeronautics and Space Administration
Armstrong Flight Research Center

What is Fiber Optics?

- Optical Fiber:
 - a dielectric waveguide which guide light throughout its length via total internal reflection
- Light can propagate in miles without signal degradation
 - Backbone of today's internet
 - Can be also used as environmental sensors

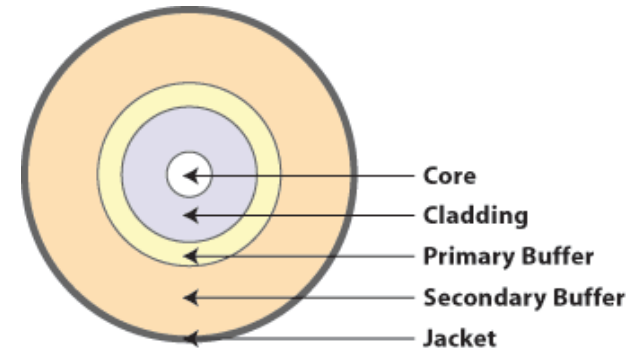
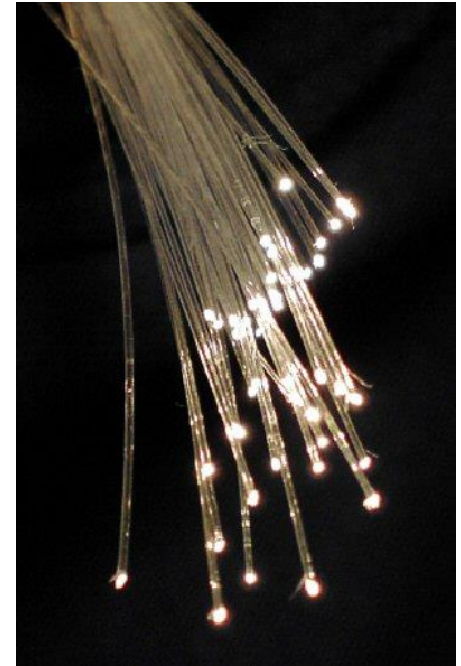
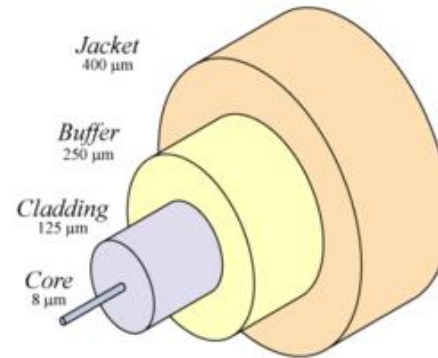

Why Fiber Optic Sensors?

One Of These Things (is Not Like The Others)

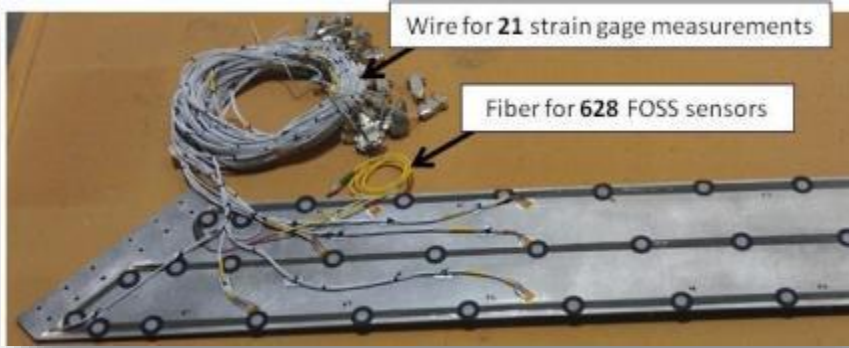

(Heavy)

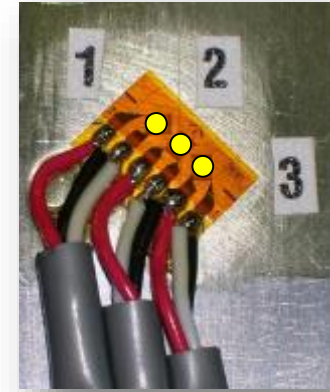

(Big)



(Hard)

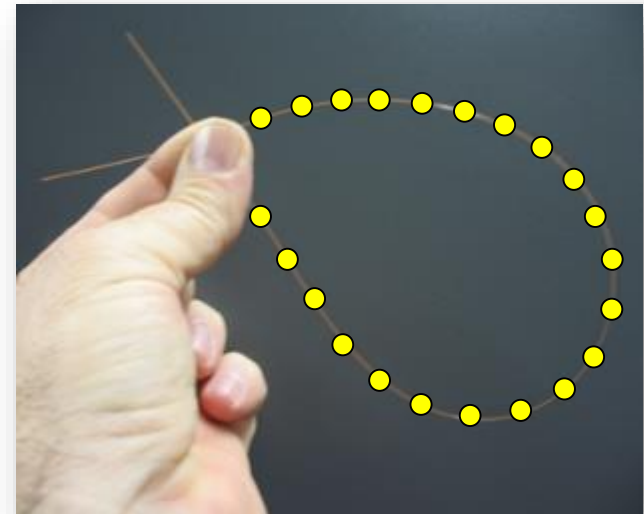

(Light, small, easy)



Why Use Fiber as sensors?

- Immunity to electromagnetic interference, radio-frequency interference, and radiation.
- Compact, lightweight, ruggedized device for smart structure
 - Embedded into structure
 - Harsh environment (under water)
- The ability to be multiplexed. (100s of sensors on a single fiber).
- Ease of installation and use (single fiber vs. multitude of lead wires).
- Potential low cost as a result of high-volume telecommunications manufacturing.
- **WEIGHT SAVING** vs Strain gauge

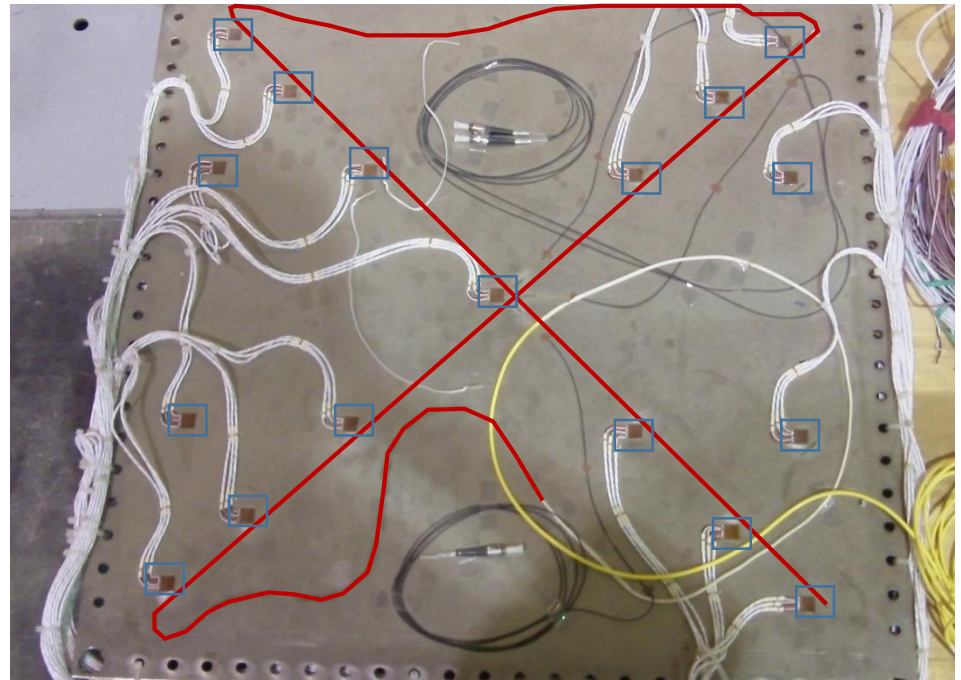

Fiber Sensor – Fiber Bragg Grating (FBG)

- Fiber Reflector that reflects a particular wavelength and transmit all others
- Developed at 1978
- Bragg Wavelength:
 $\lambda_B = 2n_e \Lambda$

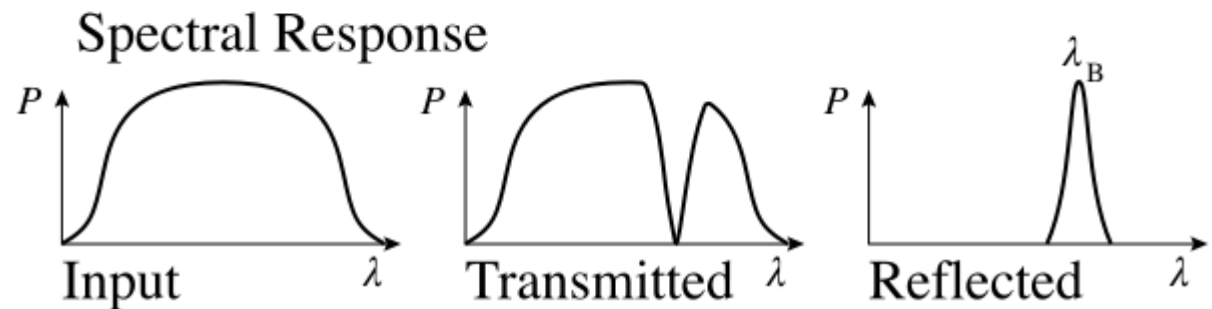
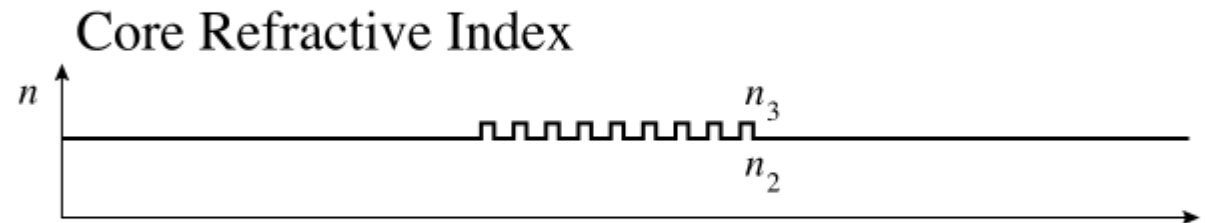
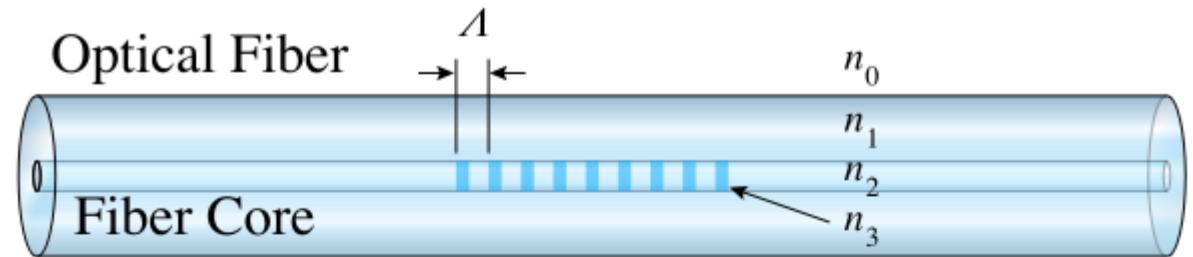

How do FBG sensors work?

- Like an accordion \rightarrow change in Bragg Wavelength

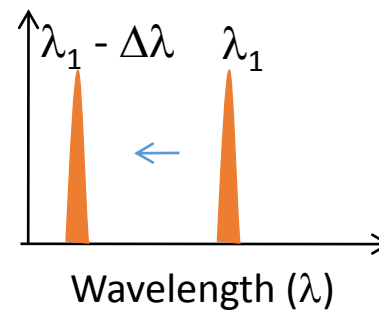
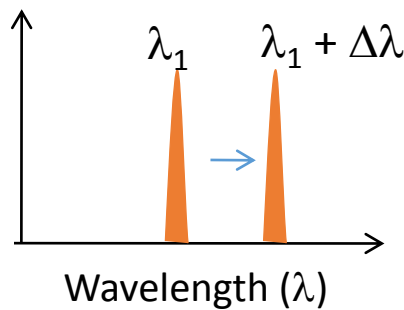
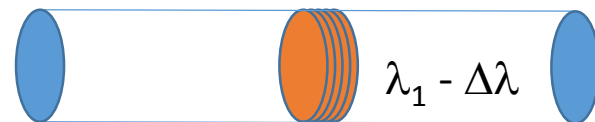
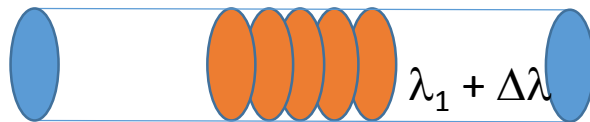
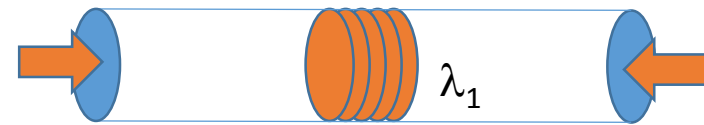
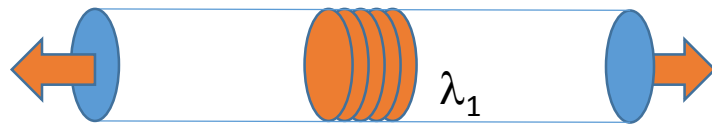

NASA patented Grating Modulation Multiplexing Method (Optical Frequency Domain Reflectometry)

- Multiplex 100s of sensors onto one fiber.
- All gratings are written at the same wavelength.
- A narrowband wavelength tunable laser source is used to interrogate sensors.
- Each sensor is only ½ inch long

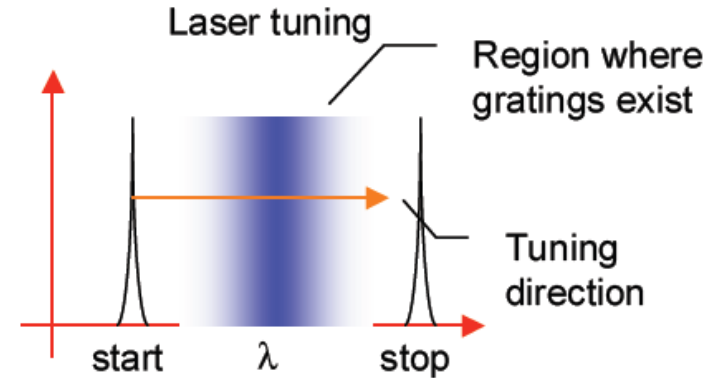

$$I_R = \sum_i R_i \cos(k2nL_i) \quad k = \frac{2\pi}{\lambda}$$

R_i – spectrum of i^{th} grating
 n – effective index
 L – path difference
 k – wavenumber

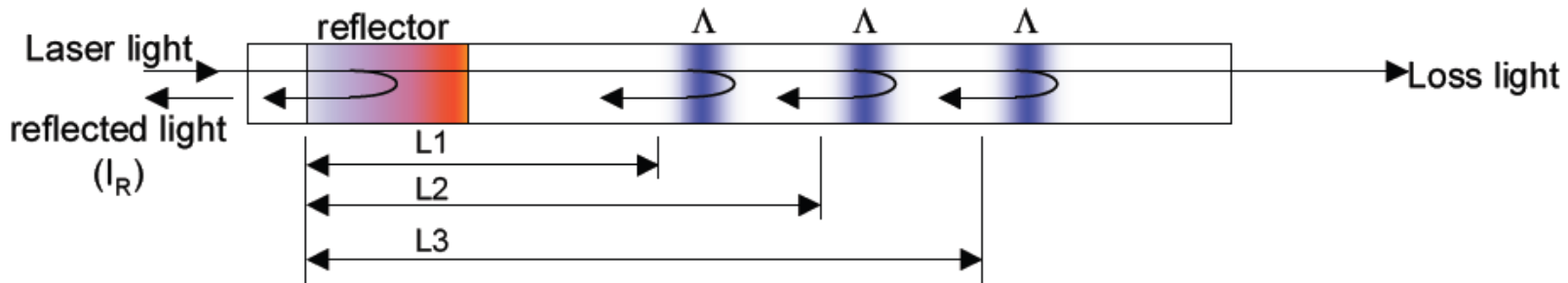

Layman's Term: Tuning your favorite radio station!

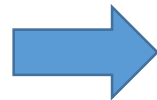

Radio receives ALL frequencies

Radio tuner accepts ONE frequency

Multiple frequencies
are broadcasted on airwave



Radio analogy to Optical Frequency Domain Reflectometry

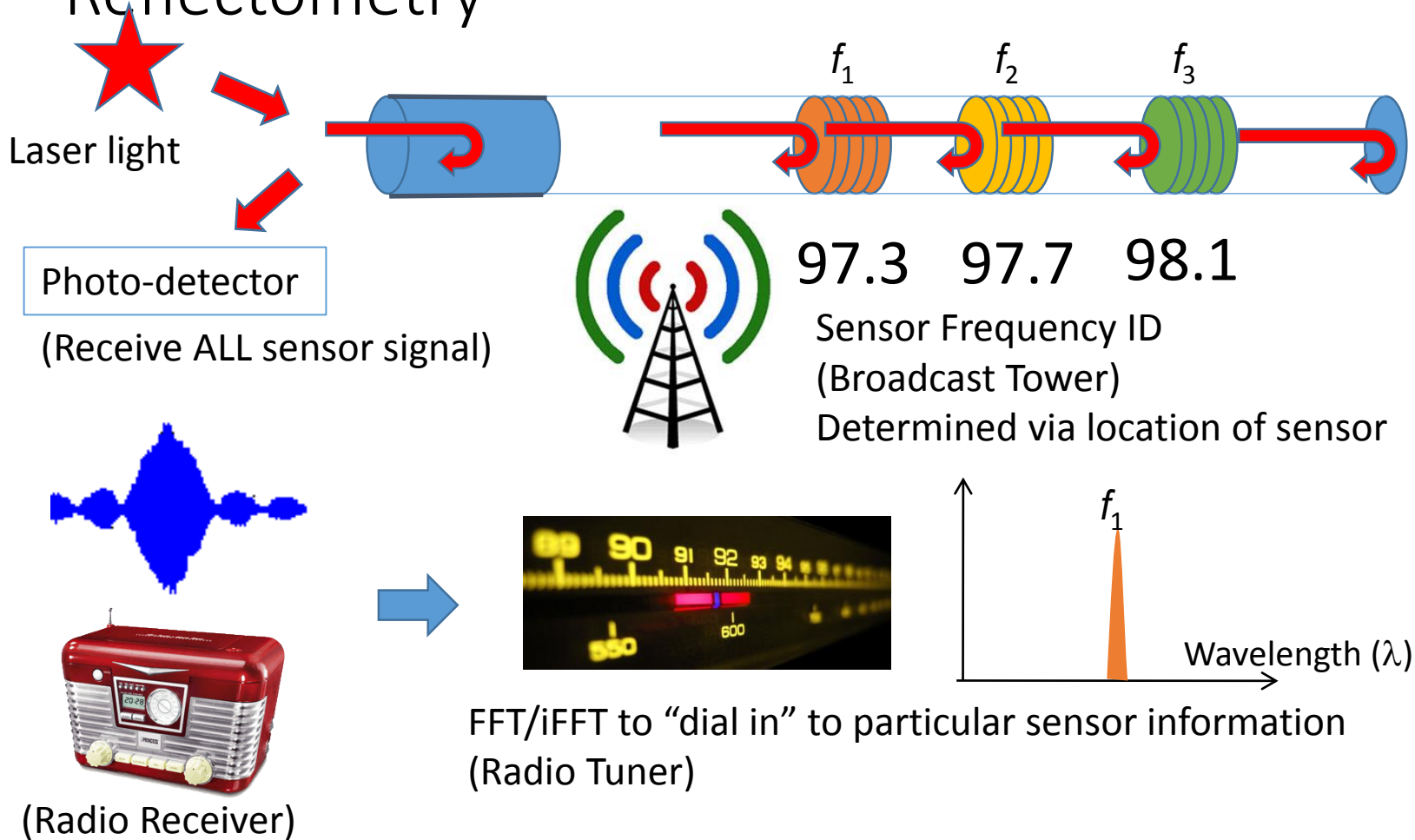

Background of Technology For Flight Monitoring

Fiber Bragg Grating (FBG) sensors in optical fibers have been used for several years to determine the temperature, pressure, and strain to which a structure is subjected

This invention uses FBG sensor data and allows end users to continuously monitor strain distribution as well as determine many other engineering parameters (i.e. stress, buckling, shape, loads, etc.)

Motivation – Helios mishap (2003)



The technology was developed for monitoring the wing displacement of unmanned aerial vehicles (UAV) to proactively prevent crashes

Helios Mishap Report – lessons learned

- Measurement of wing dihedral in real-time should be accomplished with a visual display of results available to the test crew during flight
- Procedure to control wing dihedral in flight is necessary for the Helios class of vehicle



AFRC's role in fiber sensing technology

- Technology is first pioneered/patented at NASA Langley Research Center (LaRC) during the late 90's:
 - Laboratory-based system
 - One sample being taking every 30 second (one channel).
- AFRC miniaturized and developed an “one-box system” for aerospace application
 - Compact system for flight or ground test
 - Patented improved sampling rate to 100 samples per second (multiple channels)

Parker; US Patent 8,700,358



1990's → 65lbs

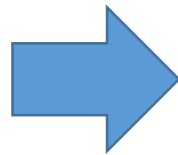

2008 → 23lbs

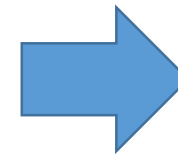

2014 → >10lbs



FOSS Fields of Operation

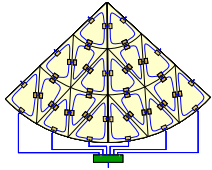

TPS Health Monitoring



Embedded Strain

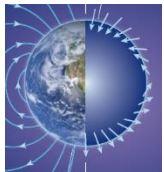

Magnetic Field



Applied Loads



Strain



Temperature and
Cryogenic
Liquid Level



2D Shape

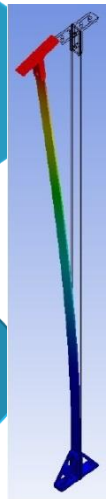

3D Shape

Project: Ikhana

- Ikhana is NASA Dryden's version of Predator-B UAV used as a "flying laboratory."
- Fiber optics are installed on forward and aft section of both wings

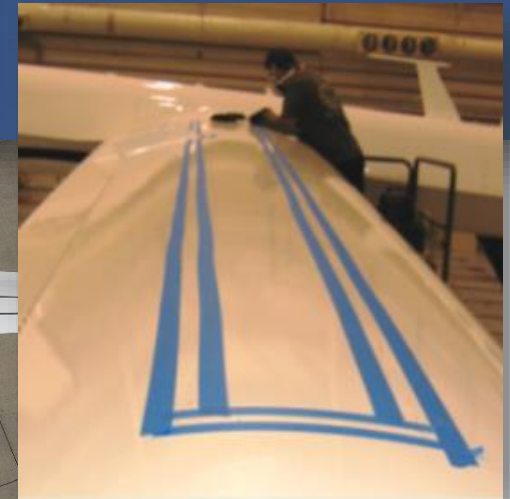
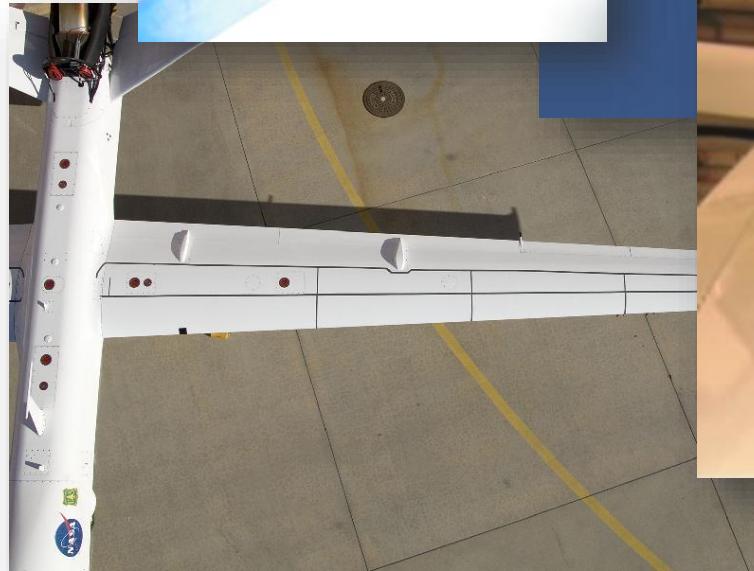
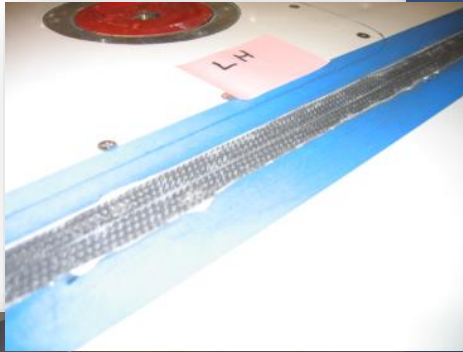

Structural Algorithms using FOSS

- Structural Shape
 - Real-time wing shape measurement using fiber optics sensors
 - (Ko, Richards; Patent 7,715,994)

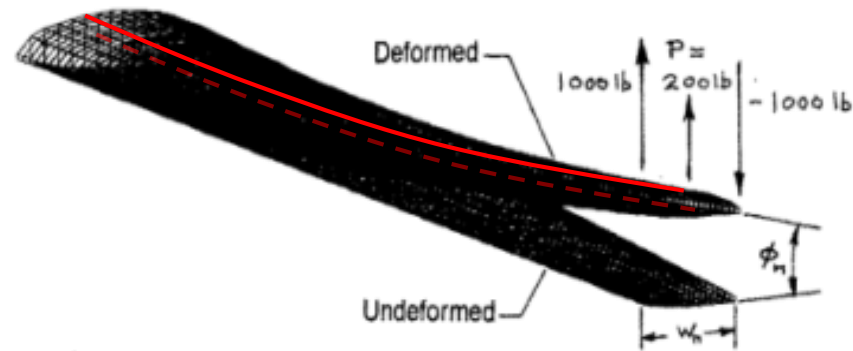

- Externally applied loads
 - Real-time applied loads on complex structures using fiber optic sensors
 - (Richards, Ko; Patent 7,520,176)

Project: Ikhana

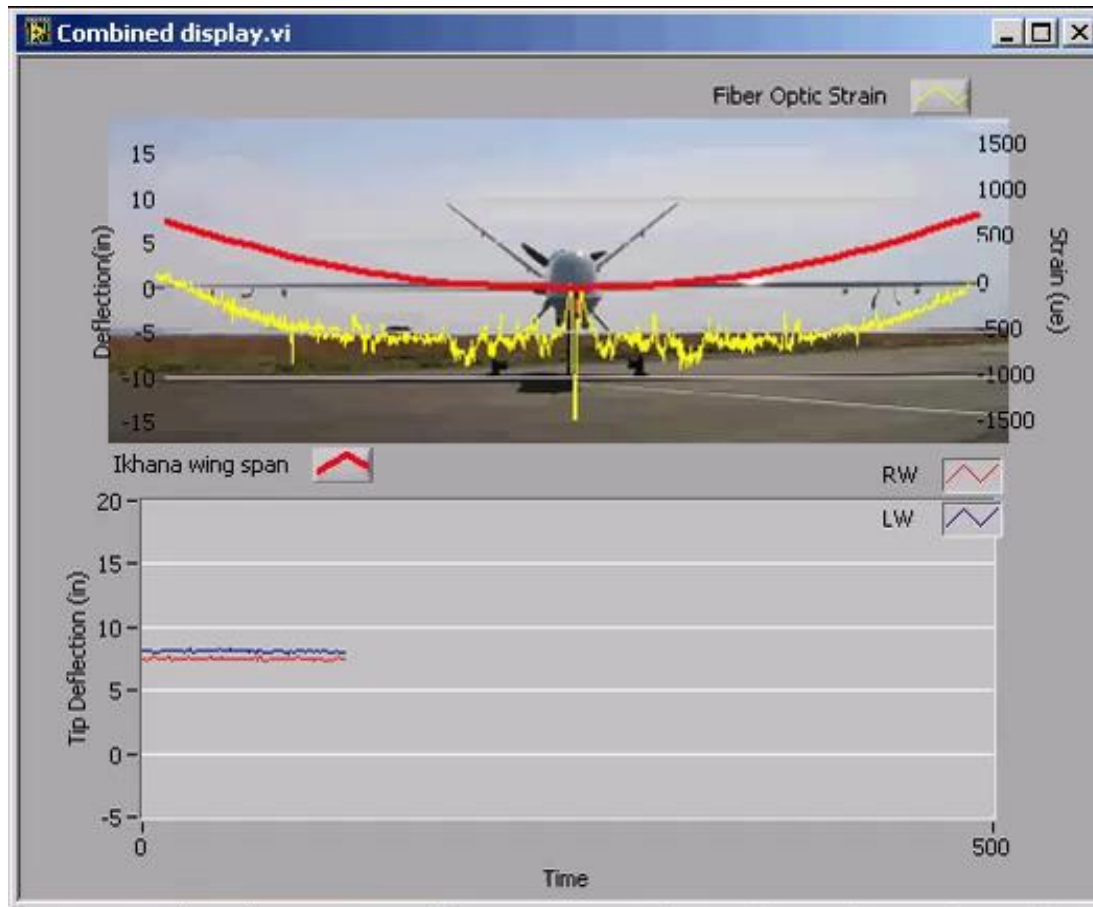

- Real-time strain data of the wing is captured during flight
- Strain data can be used for health-monitoring and feedback control



Cryogenic Liquid Level-Sensing using cryoFOSS

- The Challenge

- The transitional phase between liquid and gas of cryogenics is difficult to discriminate while making liquid level measurements
- Using discrete cryogenic temperature diodes spaced along a rake yields coarse spatial resolution of liquid level

- FOSS Approach

- While using anemometry methods the transitional phase can be mapped better
- Using a single continuous grating fiber high spatial resolution can be achieved
- In conjunction with the continuous grating fiber, Dryden's adaptive spatial density algorithm can resolve even higher spatial resolution targeting in the region where the actual level is located

- Applications:

- Launch vehicles
- Satellites
- Civil Structures
- Ground Testing
- COPV bottles

Cryogenic Container located at MSFC (below deck)

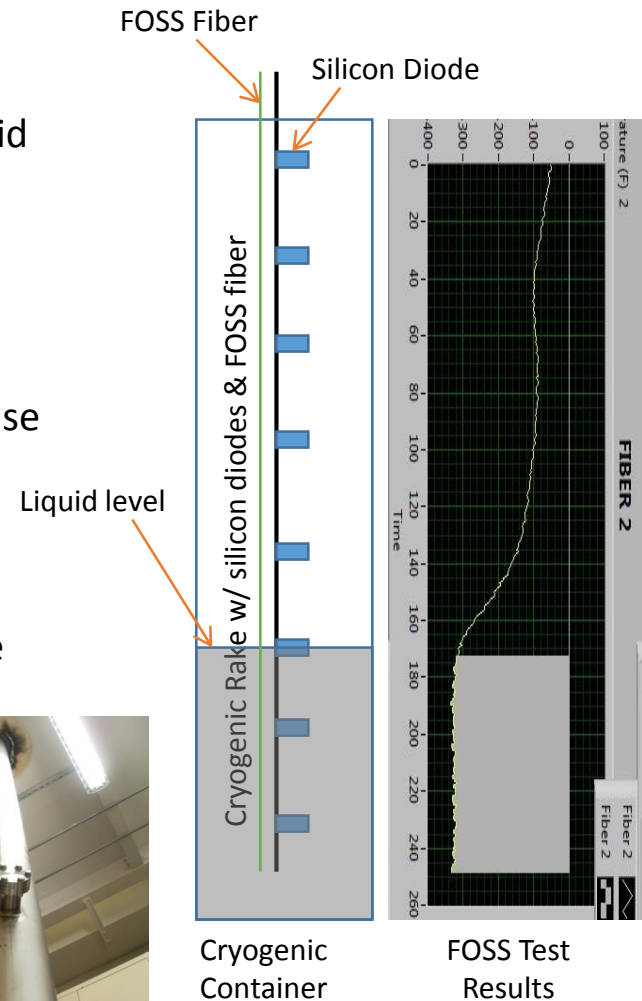

cryoFOSS deployed as LH₂ Liquid Level Sensor

Objective

- Experimentally validate Dryden-developed LH₂ liquid level sensor (cryo-FOSS) using Dryden's fiber optic strain system (FOSS) technology

Test Details

- Dewar dimensions: 13-in ID x 37.25-in
- Fill levels of ~20%, 43%, and 60% were performed
- Instrumentation systems
 - Video boroscope (validating standard)
 - Cyrotracker (ribbon of 1-in spaced silicon diodes)
 - MSFC Silicon diode rake
 - Fiber optic LH₂ liquid level sensor

Results

- ***Cryo-FOSS sensor discerned LH₂ level to approx. 1/4" in every case***
- Excellent agreement achieved between cryo-FOSS, boroscope, and silicon diode cryotracker

Bottom line

- Validated concept for a lightweight, accurate, spatially precise, and practical solution to a very challenging problem for the ground- and in-flight cryogenic fluid management of launch vehicles in the future

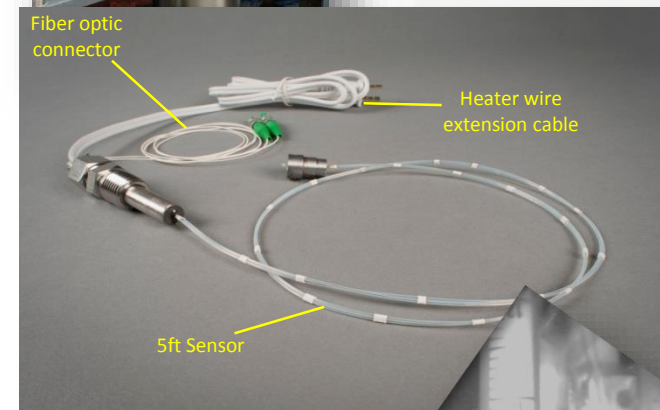

Cryo-FOSS

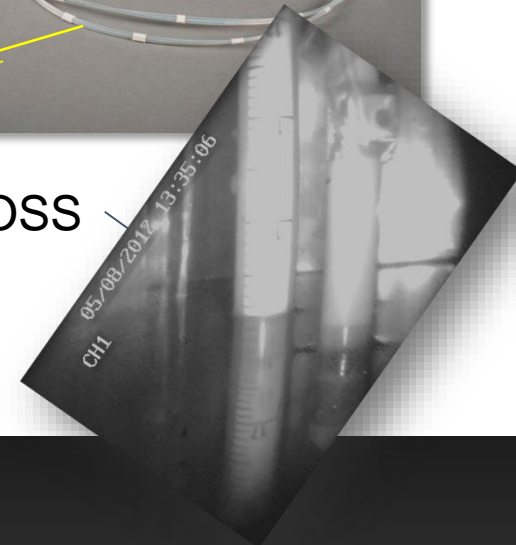

Summary

- NASA AFRC has successfully develop fiber optics strain sensors (FOSS) technology from laboratory to real-world application

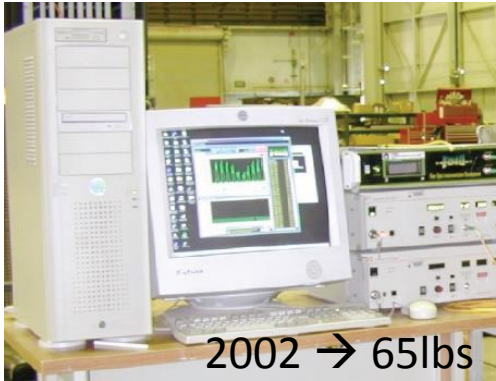

- Current status
 - FBG system are installed on numerous applications for real time sensing
 - Applications in Aerospace and beyond
- Potential application of technology beyond aeronautics
 - Automotive Sector
 - Energy Sector
 - Biomedical Sector



FOSS team at AFRC



Dr. Lance Richards

Aircraft structures,
strain measurement
research

System/Avionics



Allen Parker

Systems design & development,
data processing & visualization



Phil Hamory

Advanced System
Algorithm
Development

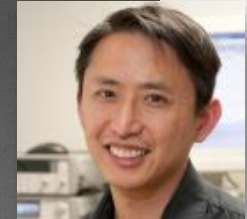

Dr. Patrick Chan

Optics
development,
laser research, &
development

Fiber



Frank Pena

Mechanical
design &
development,
Structural
Simulation
and Testing



Broadband Reflector Box (BBR)



Sensing Fiber & Attachment

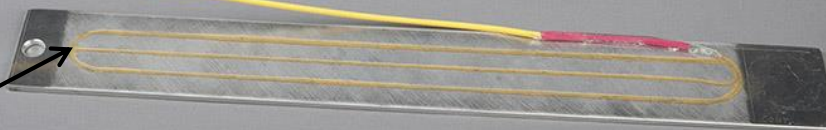

Anthony Piazza

Sensor
Characterization,
application, &
interpretation



Extra Slides



AFRC's Current FOSS Capabilities

Current system specifications

- Fiber count 8
- Max sensing length / fiber 40 ft
- Max sensors / fiber 2000
- Total sensors / system 16000
- Max sample rate (flight) 100 sps
- Power (flight) 28VDC @ 4.5 Amps
- Power (ground) 110 VAC
- User Interface Ethernet
- Weight (flight, non-optimized) 27 lbs
- Weight (ground, non-optimized) 20 lbs
- Size (flight, non-optimized) 7.5 x 13 x 13 in
- Size (ground, non-optimized) 7 x 12 x 11 in



Flight System



Ground System

Environmental qualification specifications for flight system

- Shock 8g
- Vibration 1.1 g-peak sinusoidal curve
- Altitude 60kft at -56C for 60 min
- Temperature $-56 < T < 40C$



Predator -B in Flight



Aircrafts supported: Predator-B, Global Observer, G-III

National Aeronautics and Space Administration

Armstrong Flight Research Center

cFOSS v1.0 System Specifications

- **Targeted specifications:**

- Fiber count: 4
- Max Fiber length: 40 ft
- Max # sensors/system: 8,000
- Max Sample rate: 100 Hz
- Power: 50W @ 28Vdc
- Weight(w/o enclosure): ~6lbs
- Size (w/o enclosure): 3.5 x 5.7 x 12 in
- Vibration and Shock(**targeted**):NASA Curve A (DCP-O-018)



cFOSS v1.0

- **Applications:**

- UAVs

- **Convection cooled model**

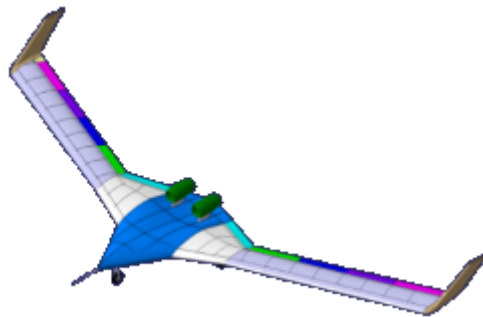

cFOSS v1.0 onboard APV-3

FOSS Technology Embedded Within Composite Overwrapped Pressure Vessel (COPV)

The Goal: Characterize the measurement response of fiber Bragg sensors embedded in COPVs

- Determine overall sensor accuracy as a function of its orientation relative to the layered materials in the structure
- Use finite element techniques to understand the thermal/mechanical loads present in the fiber optic, lenticular resin rich region, and the adjacent composite material as well as issues related to ingress/egress.
- Experimentally evaluate the accuracy and long term durability of the embedded sensor / host material system when subjected to quasi-static thermal mechanical loading

The Approach: Expands previous studies performed at DFRC/UCLA/MSFC/WSTF to evaluate the accuracy and long term durability of a fiber Bragg sensor embedded within COPVs

- Analytical modeling of the fiber optic sensor
- epoxy composite fabrication
- Quasi-static testing of coupons
- Long term fatigue testing
- Testing of representative aerospace

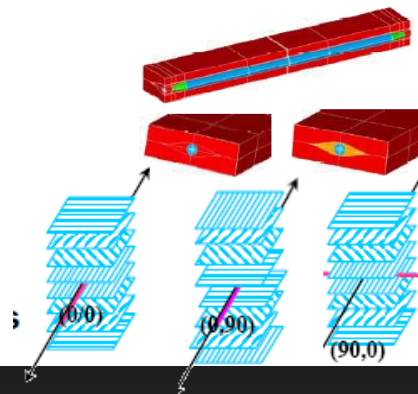

Combined Temperature and Strain Sensing

• Three fiber-optic channels measuring both strain and temperature:

• **Red fiber** bonded and will measure strain and determine shape

• **Yellow fiber** is both bonded and unbonded through polyimide tubes

• **Blue fiber** is run in Polyimide tubes to decouple from substrate, measuring temperature only

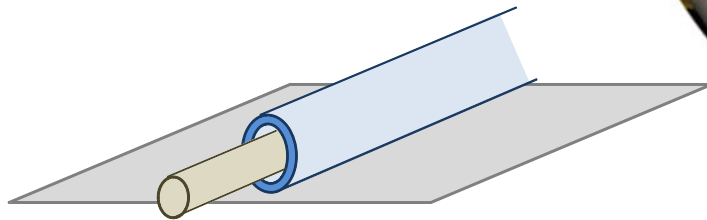

Fiber sensors move freely in polyimide tubing to decouple temperature with respect to strain

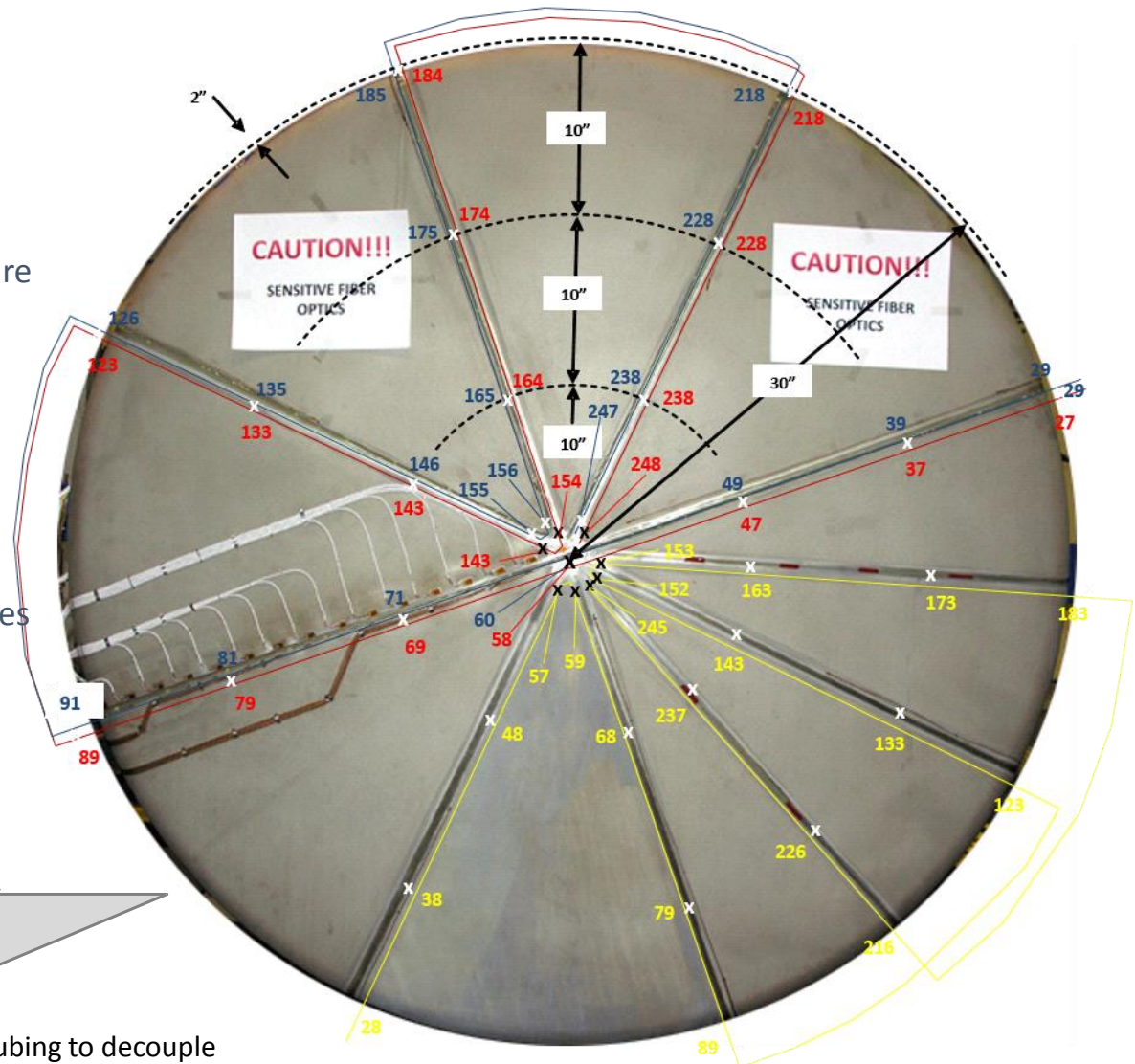

TPS Health Monitoring

- Sponsor: NNWG
- FOSS technology:
 - Strain, temperature, and shape
- Benefit to the project:
 - Thermal protection system health monitoring

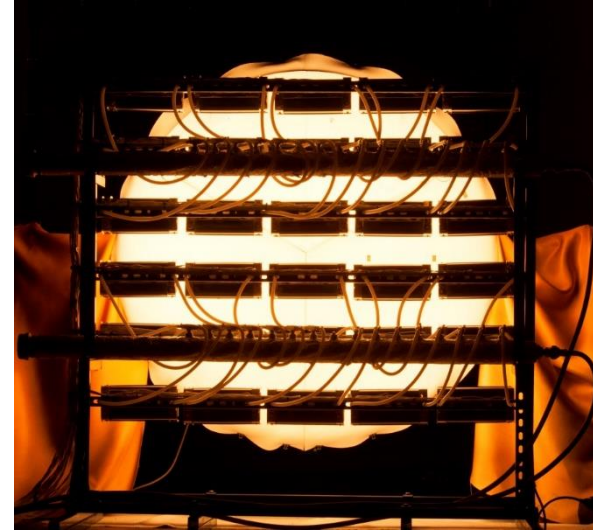
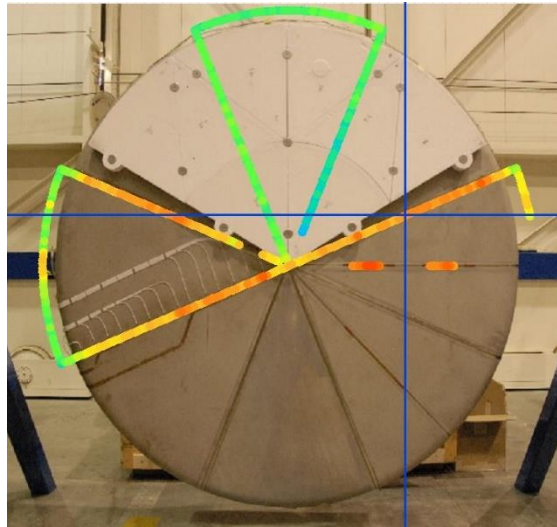

FOSS measuring strain: Composite Crew Module

- Four fibers were installed around the module's three windows and one hatch
- Real-time 3D strain distributions were collected as the module underwent 200% DLL pressurization testing
- Measured strains compared and matched well to predicted model results
- Project Conclusion:
 - ““Fiber optics real time monitoring of test results against analytical predictions was essential in the success of the full-scale test program.”
 - “In areas of high strain gradients these techniques were invaluable.”

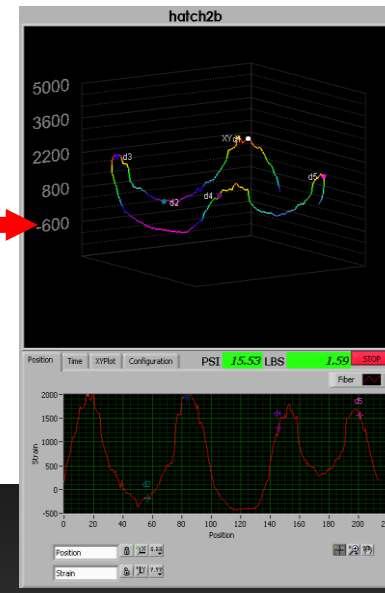
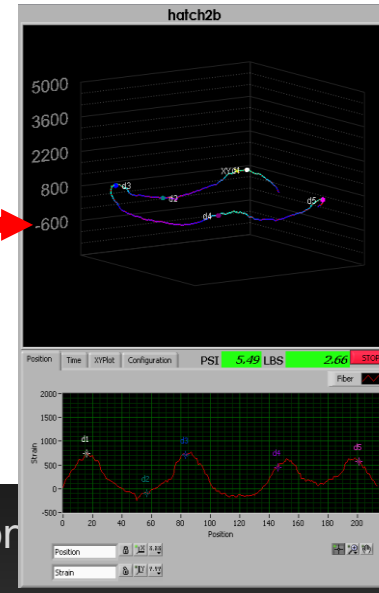
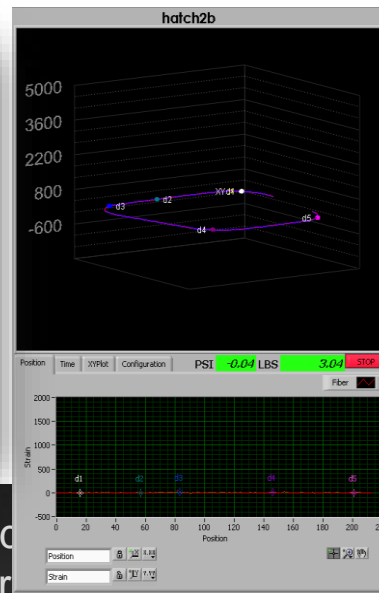
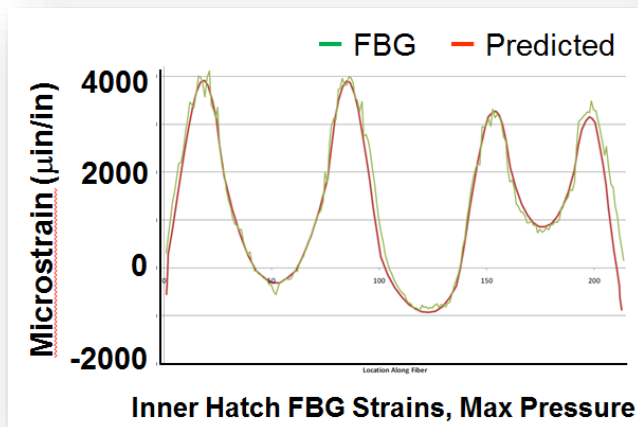

FOSS on Magnetospheric Multiscale Mission (MMS) Clamping Band

The purpose of this task is to provide FOSS support for environmental testing of the MMS stacked structure. The goal is to monitor the strain distribution throughout the various stages of testing to understand how the clamping load redistributes around the band.

Sensor installation:

- Two 20ft fiber optic sensing runs were installed on this 1.5" wide, 66" diameter band, one at the top of the band and the other at the bottom (see photo below)
- This installation was performed at GSFC in their spacecraft staging cleanroom
- A sensor zero was measured during a relaxed position for the clamping band and will be used as reference throughout all test stages

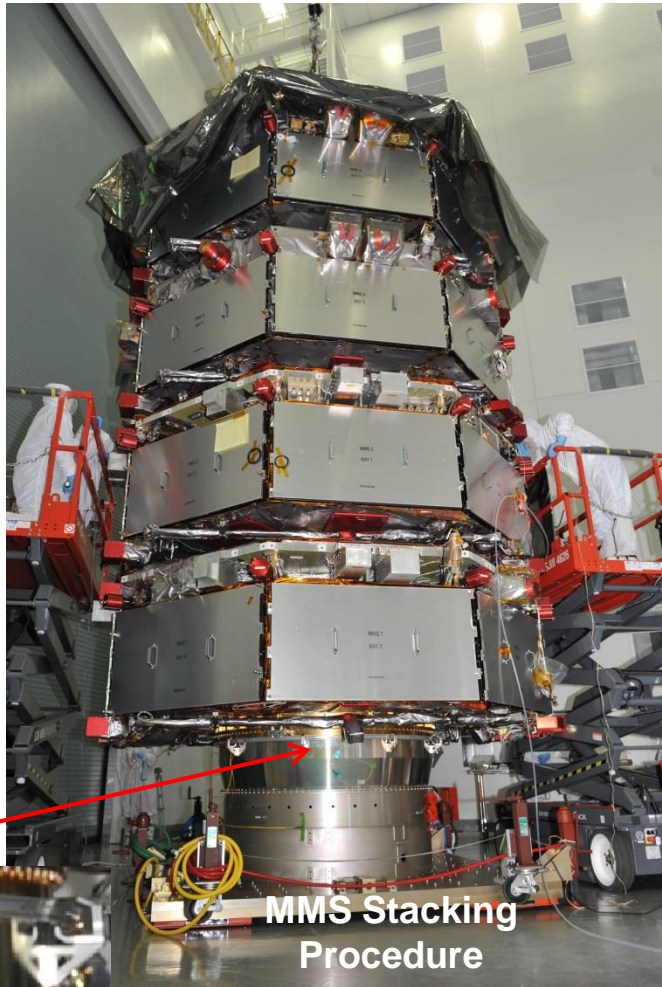

FOSS Sensing fiber mounted onto the clamping band

MMS Stacking Procedure



CRYOTE 3

- Sponsor: LSP
- FOSS technology:
 - Strain sensing, Temperature sensing, Liquid Level sensing
- Benefit to the project:
 - CRYOTE 3 being used as a test bed to further develop the Liquid Level sensing capability of FOSS
 - FOSS Temperature and strain sensing capabilities are helping to provide high fidelity data in the transition from liquid to gas state in cryogenic tanks
 - Data being used to validate models for the liquid level boundary region

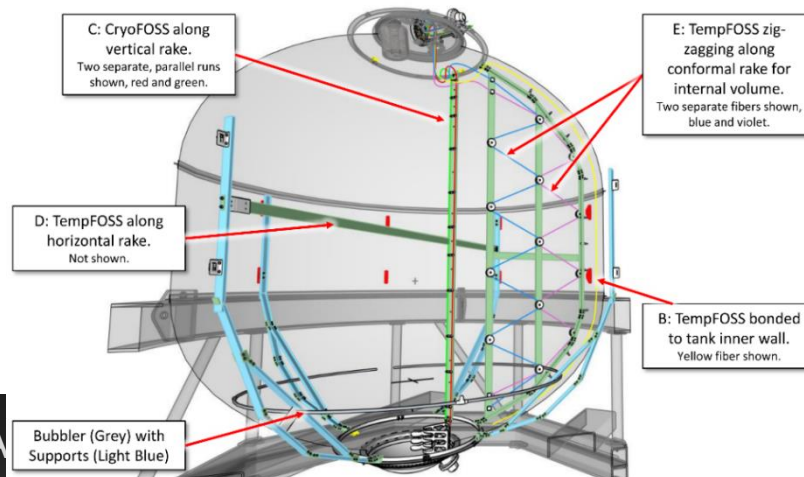

Composite Shell Buckling Knockdown Factor

- Sponsor: NESC
- FOSS technology:
 - Strain monitoring
- Benefit to the project:
 - FOSS is being used to obtain experimental validation of knockdown factor margins
 - The ability to reduce margins and maintaining safety could lead to significant weight savings

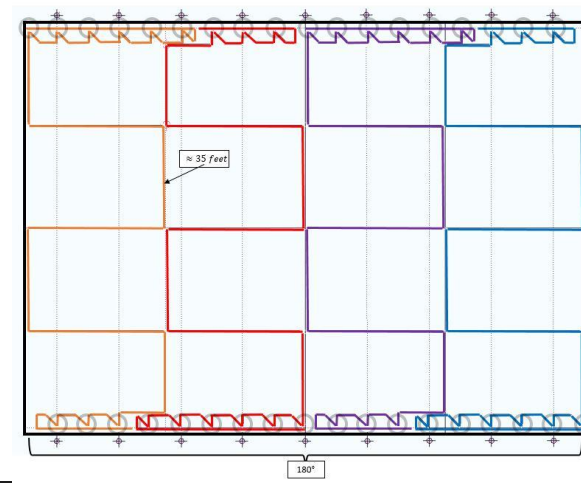
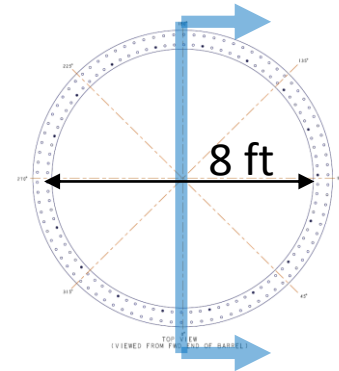

Two Strain-Based Deflection Methods

2D Shape Sensing Method

- Uses structural strains to get deflection in one direction
- Fibers on top and bottom surface of a structure (e.g. wing)

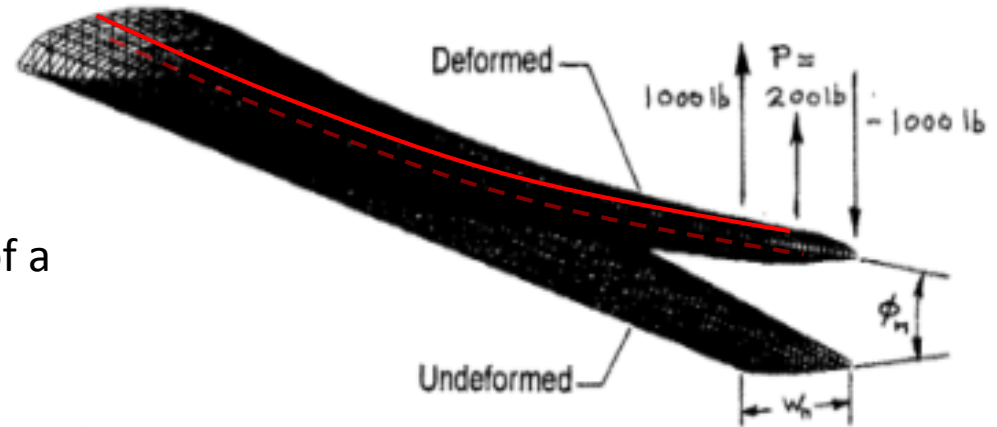

3D Shape Sensing Method

- Uses strains on a cylindrical structure to get 3D deflections
- 3 fibers 120 apart on a structure or a lumen

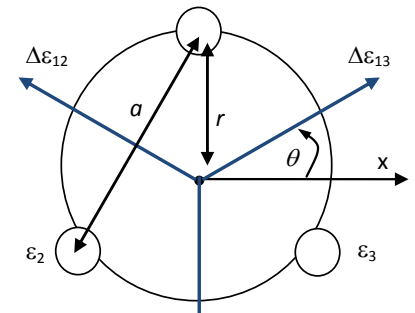
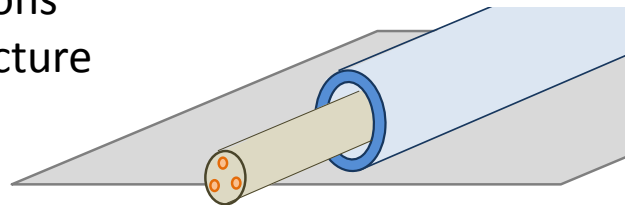

3-Core Shape Measurement

- From collaboration with NASA LaRC, shape sensing using fiber strain sensors has been realized
- Initial research focuses upon 3-core fiber
- This specialty fiber can be replaced with 3 conventional fibers superposition from one another at 120 degrees
- From knowing the strain value of each fiber, the 3-dimensional position of the fiber can be correctly rendered in real-time

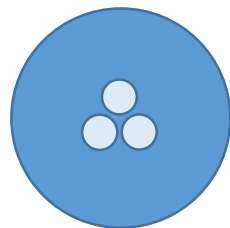

Multi-core fiber

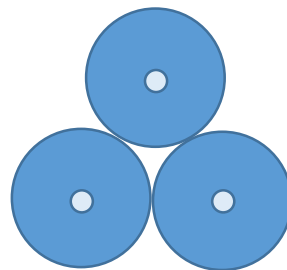

3 SMFs aligned in 120°

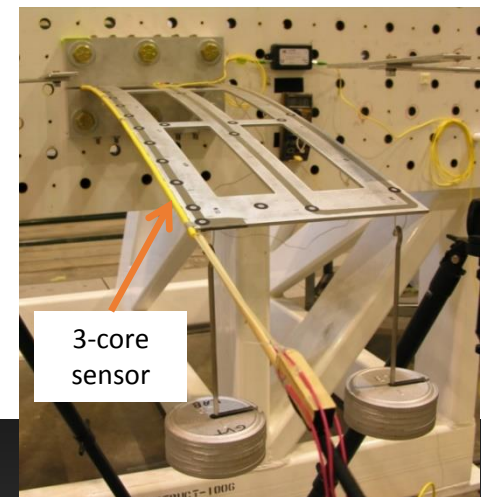

3D Shape Sensing



3D Shape Sensing on wearable

