

# Optimal Control Allocation with Load Sensor Feedback for Active Load Suppression

Christopher Miller

NASA Armstrong Flight Research Center

AIAA SciTech 9-13 January 2017

Grapevine, Texas

## Problem Statement:

- Current control applications account for structural load limits by:
  - Limiting the types of control algorithms that can be applied to a given application
  - Requiring high structural margins resulting in less efficient designs
  - Placing procedurally enforced restrictions on pilot control actions and maneuvers.
- As a result:
  - The control laws provide no explicit guarantee of structural overload prevention
  - Operators must rely on pilot awareness and training to avoid maneuvers which would damage the aircraft
  - Control laws lack adaptability to damage, system failures, and flight outside of the design flight envelope (stall/spin)
  - Aircraft structure must be overbuilt resulting higher vehicle weight and more fuel burn



**American Airlines Flight 587, Nov. 12 2001**  
**NTSB Number AAR-04/04**

*“The National Transportation Safety Board determines that the probable cause of this accident was the in-flight separation of the vertical stabilizer as a result of the loads beyond ultimate design that were created by the first officer’s unnecessary and excessive rudder pedal inputs. Contributing to these rudder pedal inputs were characteristics of the Airbus A300-600 rudder system design and elements of the American Airlines Advanced Aircraft Maneuvering Program.”*



# Conceptual Idea

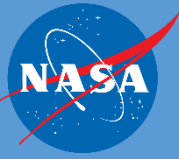

## Solution Concept:

- Distributed measurements of structural load
  - Analogous to a nervous system
- These sensors provide an indication of “pain” in the aircraft structure to the controller
- Control system redistributes control away from overloaded structure
  - Analogous to a “limp” reflex
- Control law utilizes secondary surfaces with available margin to achieve desired dynamic response

## Key Benefits:

- Enables lighter weight aircraft structure
- Automatically adapts to many damage scenarios
- Increases aircraft robustness in loss of control scenarios
- Enables advanced control techniques



# Experiment Objectives and Scope

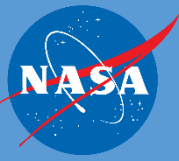

- Develop a control law utilizing Optimal Control Allocation with structural feedback for evaluation on a full scale piloted vehicle
- Utilize existing aircraft instrumentation on a robust platform in a limited envelope to help steer future developments
- Utilize measured strain within an optimal control allocator to actively limit the sensed aileron hinge-moments to specified values while maintaining aircraft handling qualities and performance
- Specific Objectives:
  - Objective 1: Limit the aileron motion subject to a defined load constraint.
  - Objective 2: Maintain the roll performance of the original controller that does not utilize structural load as a constraint.
  - Objective 3: Maintain the handling qualities ratings of the original controller that does not utilize structural load as a constraint.

- Based on an existing Nonlinear Dynamic Inversion control law framework utilized for past experiments on the Full-scale Advanced Systems Test-bed (FAST)
- Reference Models
  - Compute desired vehicle dynamics from pilot commands
- Proportional plus Integral Compensator (PI)
  - Adds robustness and disturbance rejection
- Aerodynamic Tables (Aero Tables)
  - Tabulates control surface effectiveness
- **Control Allocator (OCLA)**
  - Computes surface positions to produce desired dynamics, limit loads, and trim the aircraft
  - Primary research topic for this work
  - Based on the optimization of a cost function
- Structural Filters
  - Prevent undesirable structural modal interactions from coupling with the control laws

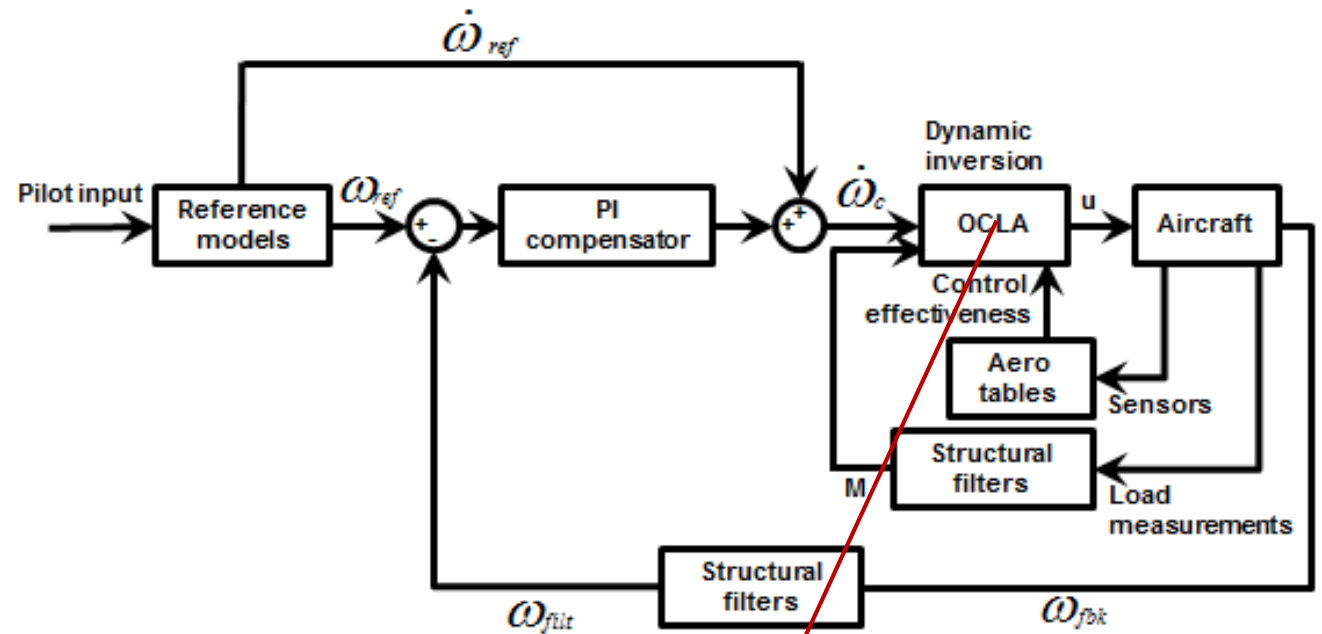

$$J = \|Bu - a_d\|_2^2 + \varepsilon \|H(u - u_p)\|_2^2 + \gamma [\|M + L(u - u_m)\|_2^2]^n$$

- Must balance surface usage priority based on sometimes competing objectives:
  - Tracking of pilot commands
  - Returning the surfaces back to desirable trim locations
  - Limiting sensed load
  - Account for surface position and rate limits (not implemented for this experiment)
- “Optimal” usage defined by a cost function developed for balancing these priorities to achieve:
  - Desirable tracking performance (J tracking)
  - Facilitate commanding surface positions for vehicle trim (J trim)
  - Provide hard limits based on sensed load, while allowing free motion at low loads (J load)

$$J = \overset{\text{J tracking}}{\|Bu - a_d\|_2^2} + \overset{\text{J trim}}{\varepsilon \|H(u - u_p)\|_2^2} + \overset{\text{J load}}{\gamma [\|M + L(u - u_m)\|_2^2]^n}$$

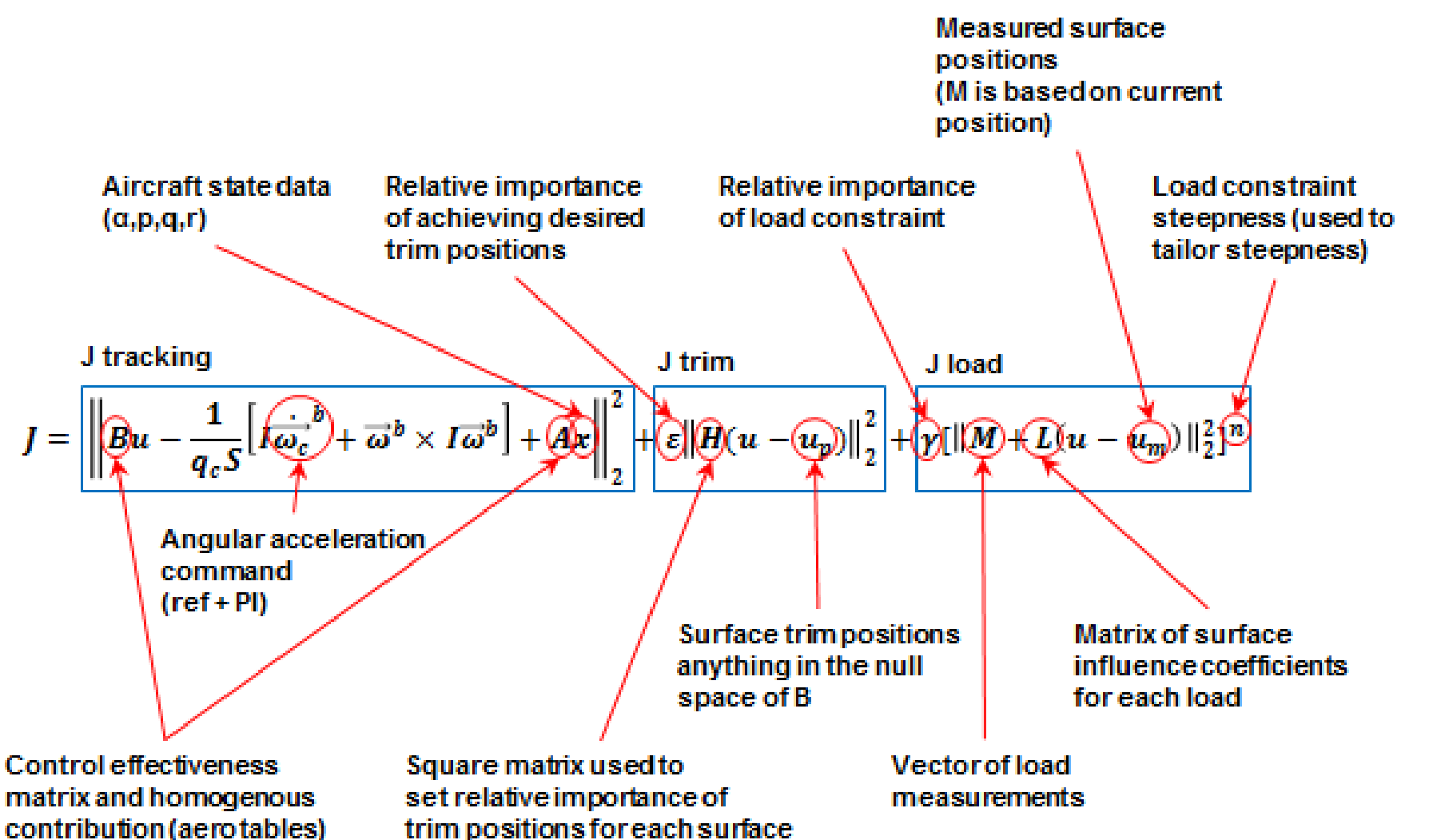

- Decreasing  $\gamma$  (not shown)
  - Increases the load at which transition between aileron and Stab/TEF dominates roll (better aileron usage)
  - Leaves some residual aileron command at high load (undesirable)
- Increasing  $n$  (shown on the right right)
  - Increases load at which transition between aileron and Stab/TEF dominates roll (better aileron usage)
  - Allows full transition away from aileron usage prior to 100% load (desirable)

$$J = \underbrace{\|Bu - a_d\|_2^2}_{\text{J tracking}} + \underbrace{\varepsilon \|H(u - u_p)\|_2^2}_{\text{J trim}} + \underbrace{\gamma [\|M + L(u - u_m)\|_2^2]^n}_{\text{J load}}$$

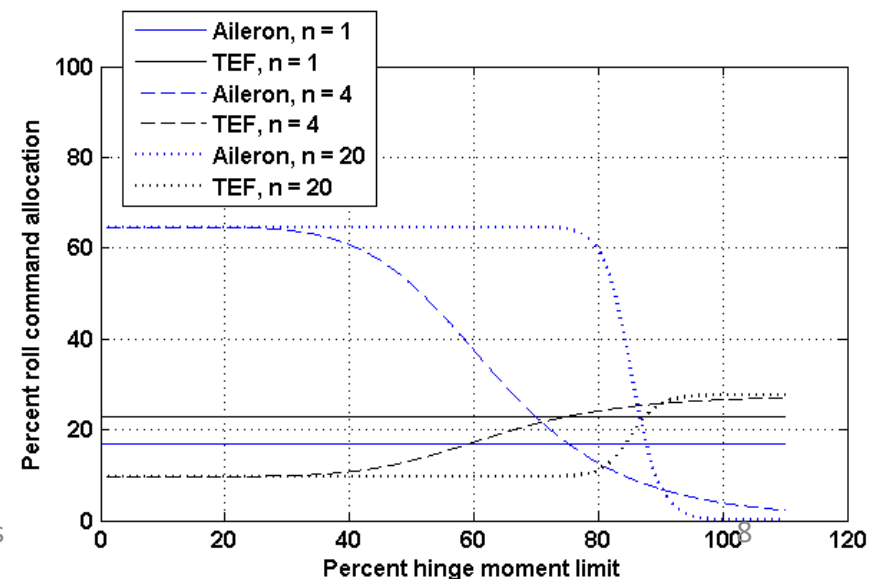
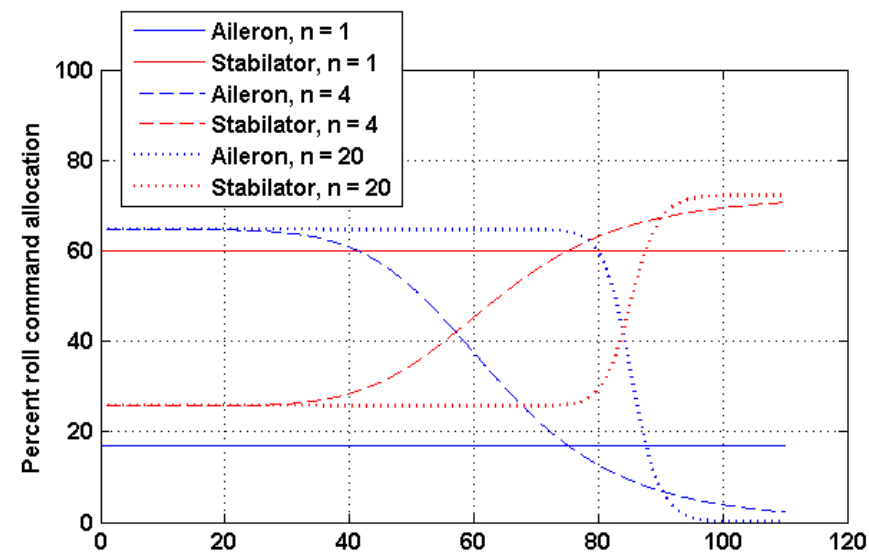





# Cost Function Optimization

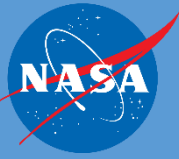

- Key Optimization Features:

- Continuous and twice differentiable with respect to surface commands
- Second derivative positive definite if B, L and H are properly conditioned
- Forms a convex space with a global minimum at  $\frac{\partial J}{\partial u} = 0$ 
  - Any iterative scheme should monotonically decrease the value of the cost function
- Does not require a unique mapping from loads to surface commands to implement optimization constraints

- Optimization Implementation Details:

- Modified Newton-Rapson
  - Relaxation factor to reduce step size if cost value increases for a given iteration
- Rank and condition number checks on B, and  $\frac{\partial^2 J}{\partial u^2}$
- Iteration number limited to prevent frame over runs
- Convergence verified with both final cost function value and the norm of  $\frac{\partial J}{\partial u}$
- Failures to converge or poor condition numbers trigger an automatic disengage and return control to the production control laws

$$J = \left\| Bu - \frac{1}{q_c S} [I \dot{\omega}_c^b + \bar{\omega}^b \times I \bar{\omega}^b] + Ax \right\|_2^2 + \varepsilon \|H(u - u_p)\|_2^2 + \gamma [\|M + L(u - u_m)\|_2^2]^n$$

- Loads sensor model developed for use in the simulation
  - Based on least squares of past flight data
  - Nonlinear corrections necessary for high angle of attack
    - Large amount of high frequency buffet
    - Determined to be real load, not signal noise, observed at high angle of attack
    - Simply filtering it out for flight not an option
  - Strain models implemented in the high fidelity nonlinear hardware in the loop simulation for experiment development and checkout
- Signal properties considerations for flight
  - Fragile single string foil strain gauges used for flight control feedback
  - Required health monitoring that approached a fail-op, triplex redundant system
  - Some filtering applied to strain signals to mitigate SMI concerns

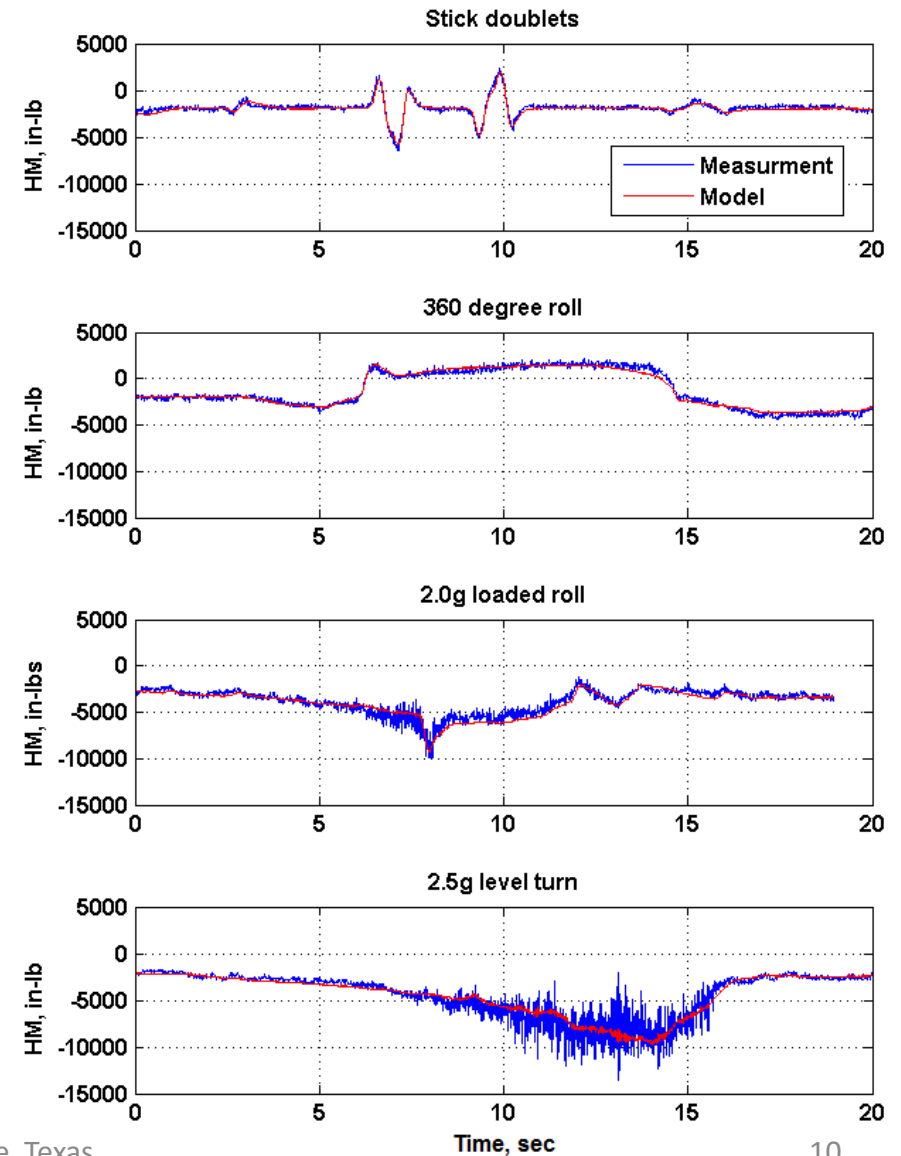



# Simulation Results – 360° Roll

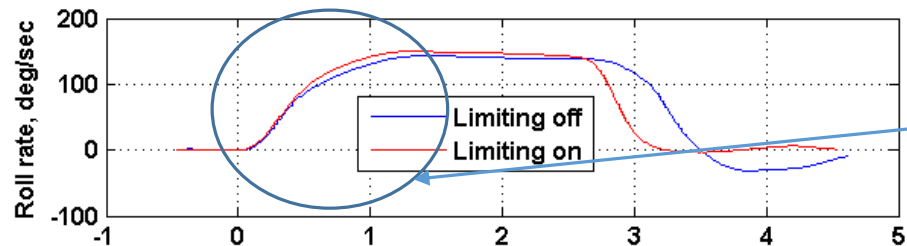
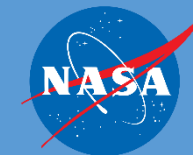

Preserves peak roll rate, and roll rate onset

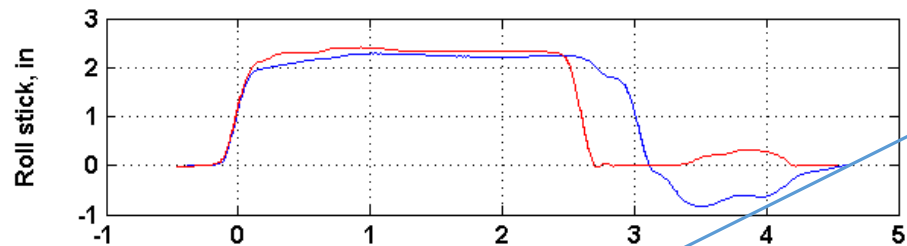

Actively limits sensed aileron hinge-moment

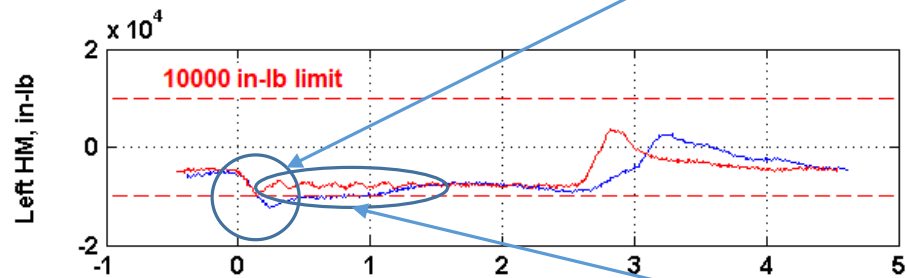

Redistributes control away from ailerons and to other surfaces

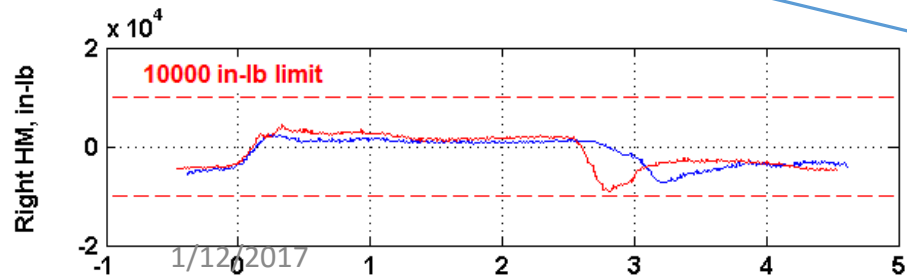

Small amount of undesirable oscillation on left hinge moment  
\*Related to time delay

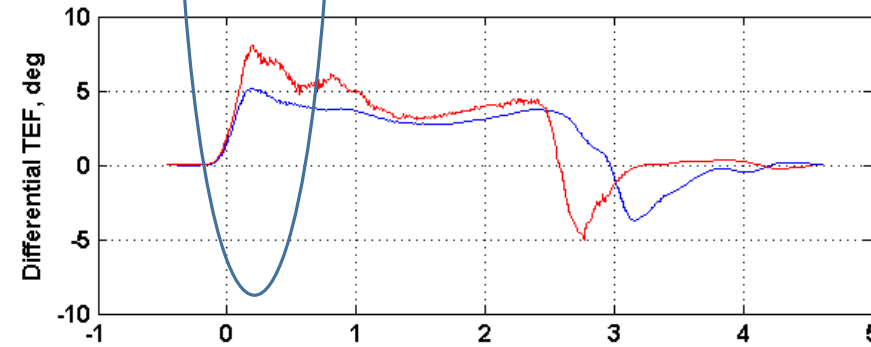
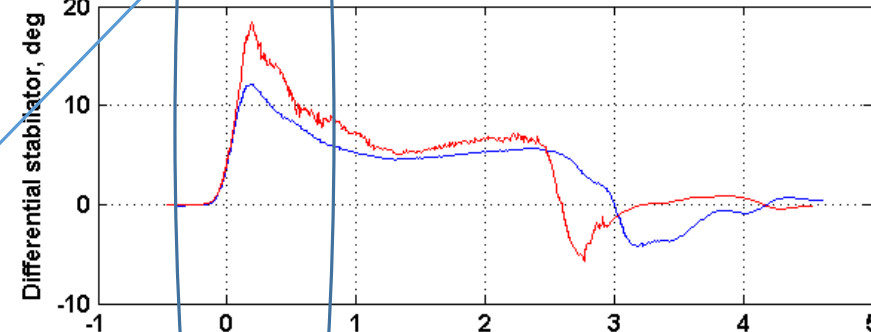
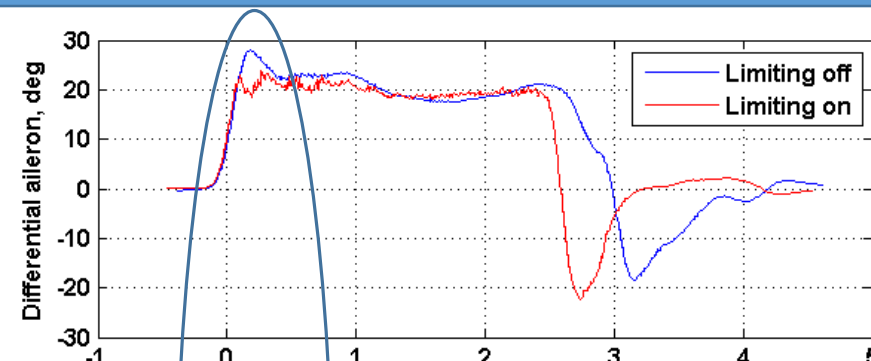

1/12/2017

- Low Order Equivalent Systems analysis tools were used to evaluate the effect of the load limiting on roll performance:

$$\frac{p}{dap} = \frac{K\omega_n^2 e^{-0.08s}}{s^2 + 2\zeta\omega_n s + \omega_n^2}$$

- Roll Mode Gain (K)
  - Analogous to the peak steady state roll rate achievable
  - Decreases with more restrictive hinge-moment limits due to the loss of roll moment available as aileron commands are limited
  - Steep load constraints delay the onset of this performance reduction by allowing the ailerons to be used close to their specified limits
- Roll Mode Time Constant ( $1/\omega_n$ )
  - Higher time constants suggest more sluggish roll rate onset
  - More restrictive limits translate to more sluggish roll modes
  - Steep load constraints delay the onset of the reduction in roll rate onset performance
- Overall, load limiting had a minimal effect on the roll performance for a well tuned cost function

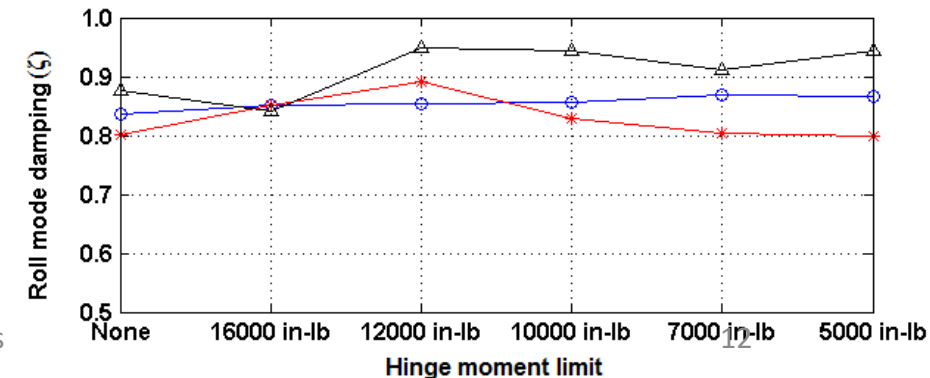
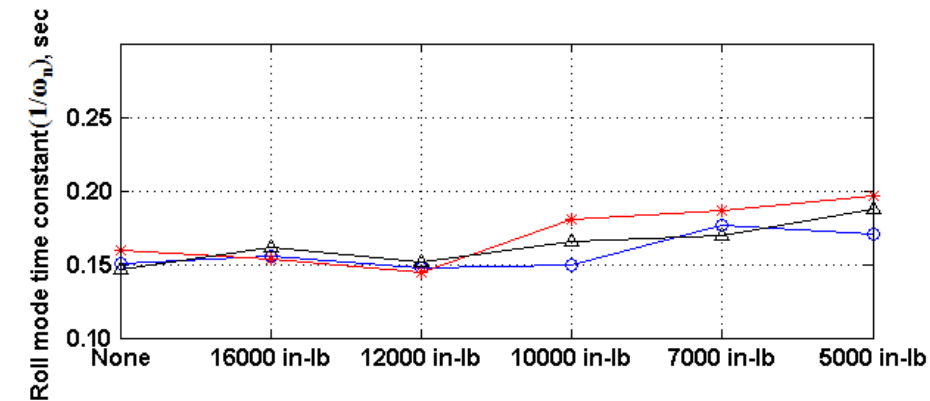
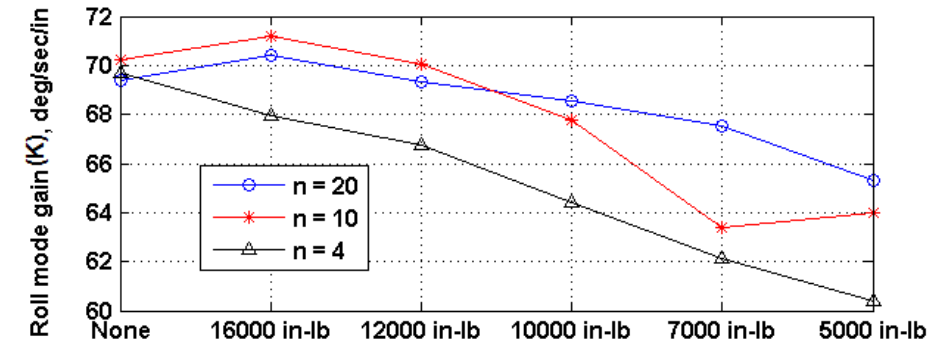

# Simulation Results – 2.5g Level Turn

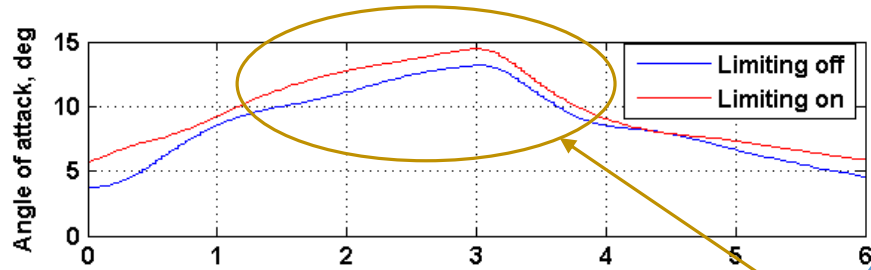

Actively limits sensed aileron hinge-moment

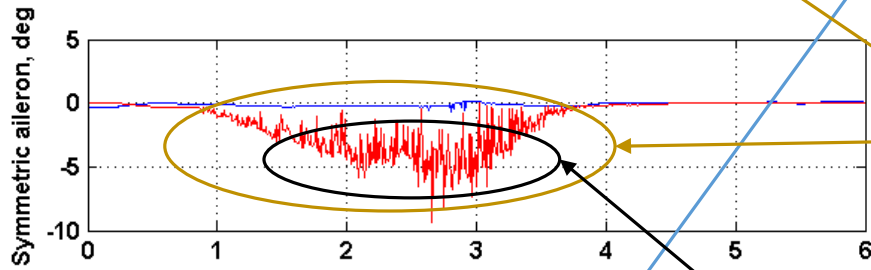

Trades slight miss-trim of symmetric ailerons for load alleviation resulting in slight angle of attack increase

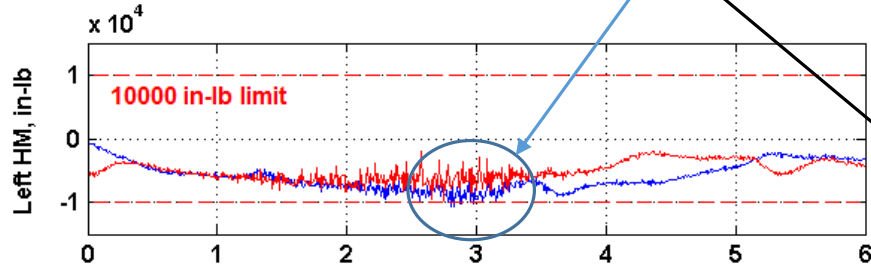

Buffet from separated flow over the ailerons results in high frequency dither of symmetric aileron

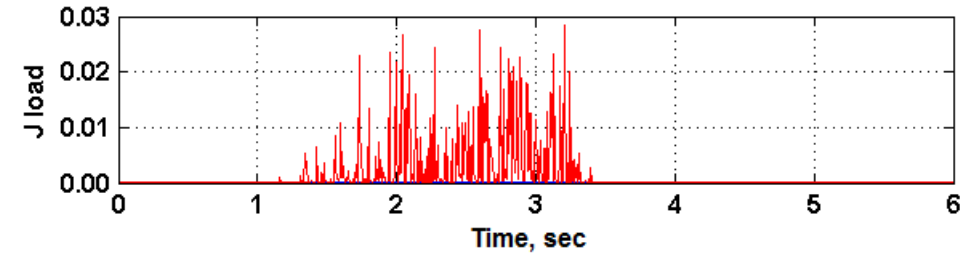
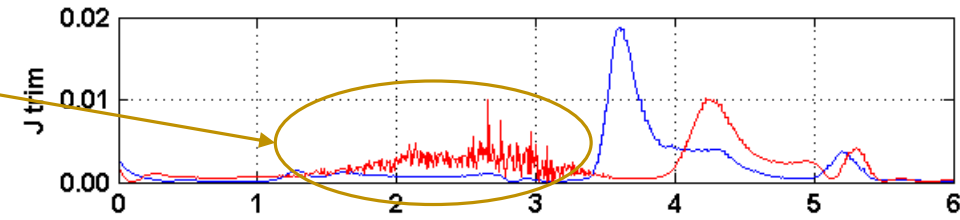
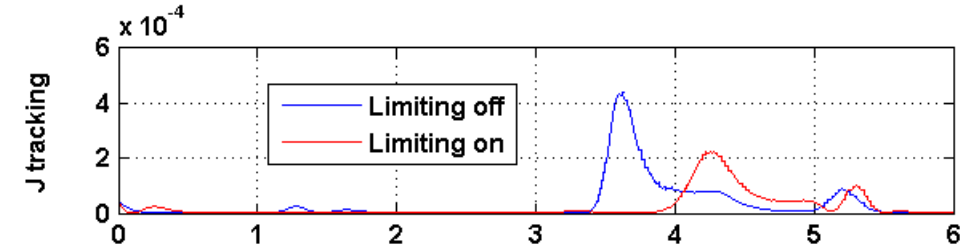
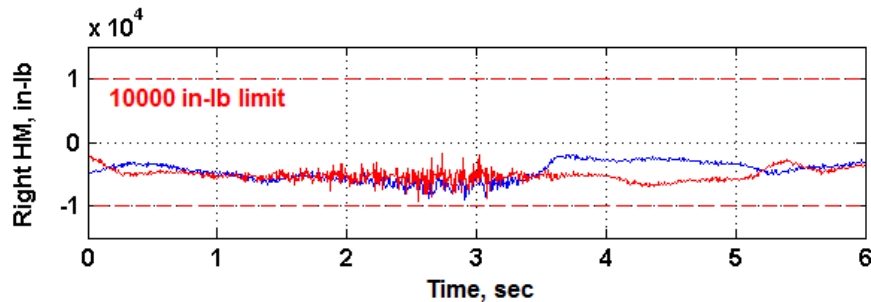



# Simulation Results – Optimization Convergence

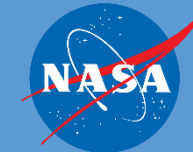

### 360° Roll with active load limiting

The load constraint dominates the cost function for the first few iterations

### 2.5g Level Turn with active load limiting

Reducing the cost associated with the load constraint has minimal effect on the tracking constraint (lowest order of magnitude)

The cost associated with the trim constraint increases as a result of attempting to minimize the load and tracking cost function values

Monotonic reduction in the norm of the first derivative, more iterations are needed when the load constraint is activated by high freq. content

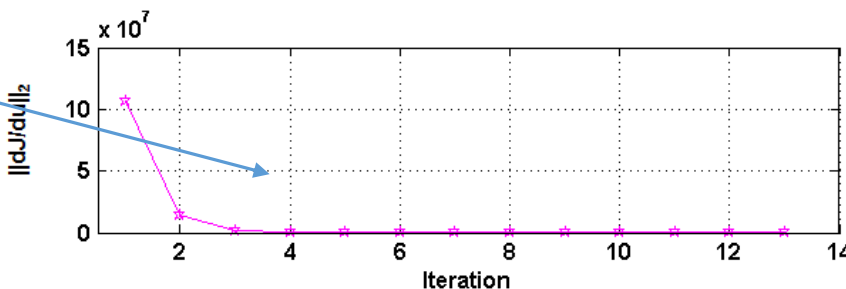
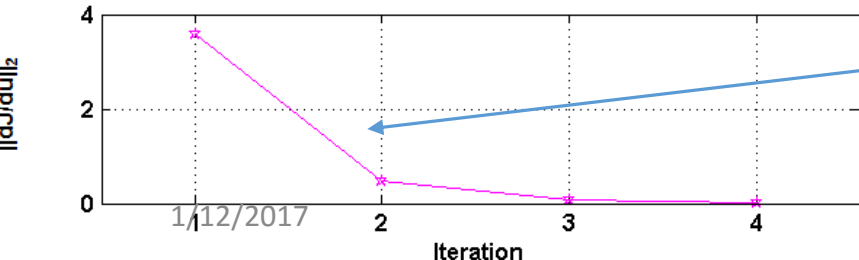
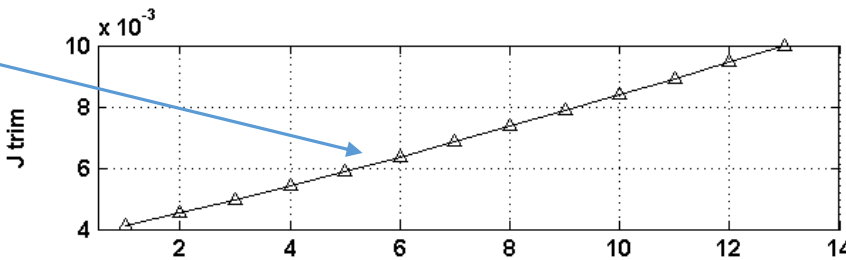
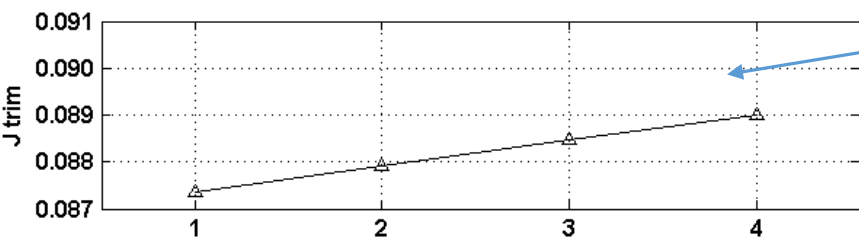
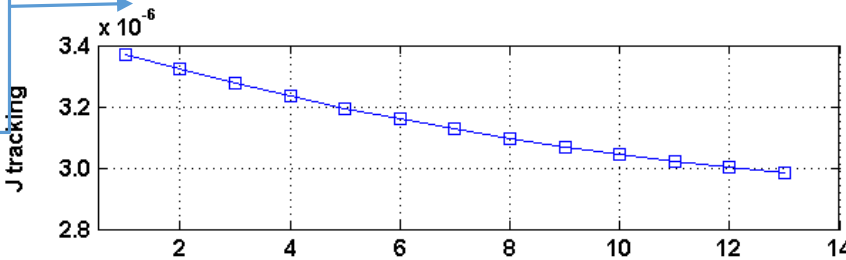
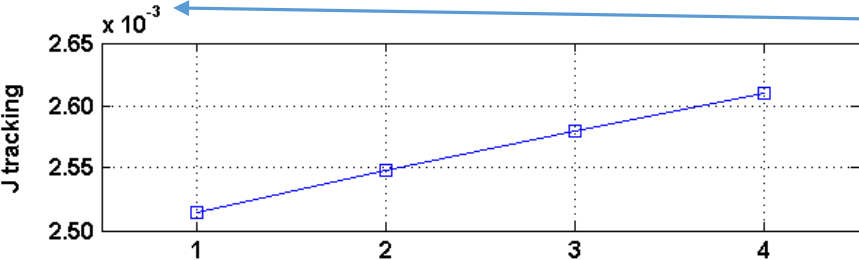
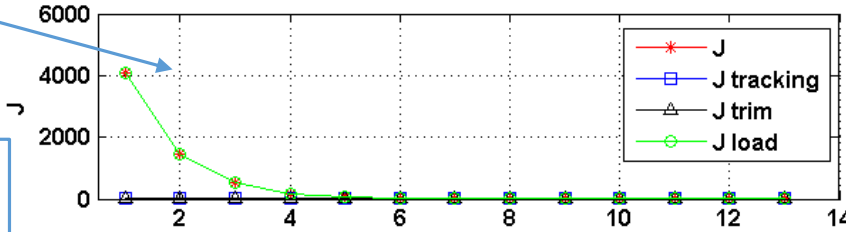
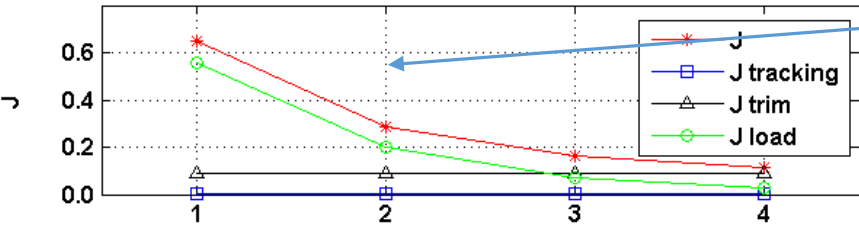



# Conclusions

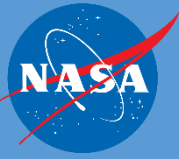

- The optimal control approach with load limiting accomplished the following:
  - Limited the sensed load to a specified value 100% of the time
  - Provided hard load constraints at high loads, but allowed the free use of all control surfaces at low sensed loads.
  - Does not require a unique mapping between loads and surface commands.
  - Redistributed control commands and loads away from structure that is near limit loads, and to control surfaces with remaining control capability and structural margin
  - Had minimal effects on the aircraft control performance when well-tuned
  - Tuning of the cost function was found to be straight forward and intuitive, with the necessary design flexibility to meet a wide array of performance objectives
  - The cost function forms a convex space with a global minimum and can be optimized by computationally simple algorithms
- A number of issues meriting further research were uncovered:
  - There is a need for robust redundant instrumentation of both critical loads and control surface positions with high sample rate and minimal delay.
  - Aggressive load limiting was found to be susceptible to performance issues related to time delay on feedback signals
  - Aerodynamic buffet was found to be especially challenging to account for and resulted in undesirable surface dither, increases in controller bandwidth and reductions in time delay may help address this challenge
  - Additional work needs to be done to prove out this type of an iterative optimization technique for an application without a robust backup control algorithm

