

Using the General Mission Analysis Tool (GMAT)

Steven P. Hughes (NASA GSFC)
Darrel J. Conway (Thinking Systems, Inc.)

Portions of this presentation were written by members of the GMAT team and are used with their permission.

NASA Goddard Space Flight Center

Tutorial Overview

- GMAT Basics (D. Conway)
- Mission Design Walk-Through (S. Hughes)
- GMAT Navigation Example (D. Conway)
- CSALT Demo (S. Hughes)
- Wrap-Up (S. Hughes)

Outline

I. GMAT Overview

II. Key Concepts

- a. Two Parallel Interfaces
- b. Resources and Commands
- c. Fields and Parameters
- d. Execution Model

III. Tour of the Graphical User Interface

- a. GUI Controls
- b. Resources Tree
- c. Mission Tree
- d. Output Tree
- e. OrbitView

IV. Tour of the Script Language

- a. Basic Syntax
- b. Control Structures
- c. Using Math
- d. Using Parameters
- e. Solvers
- f. Script Editor
- g. Best Practices

V. A Quick Demo



GMAT
OVERVIEW



GMAT

GMAT Timeline

- Design Started in 2002
- Development Began in early 2003
- Initial Fully Functional Build: 2004
- First Public Demonstration/Release: 2007
 - Alpha/pre-Beta System
 - Used for Mission Design and Analysis
- First Public Beta Release: R2011a
- First Production Release: R2013a
 - First Operationally Ready Release
 - Target: The Advanced Composition Explorer (ACE)
- Current Release: R2016a
 - First Production Ready Navigation Release
 - Target: The Solar and Heliospheric Observatory (SOHO)

System Features

- Platforms Supported: Windows, Mac, Linux
- External Interfaces: MATLAB and Python
- Development Approach: Modified Open Source
 - Developed Behind a NASA Firewall
 - Periodic Public Releases of Builds and Code
 - Supports a Robust Plugin Framework
- Extensively Tested
 - More that 13000 Core Code Tests Run Nightly
 - More that 3000 GUI Tests

Mission Design and Nav. Applications

- Orbit design, optimization, and selection
- Control design
- Visualization
- Orbit product generation and delivery
- Event detection/prediction
- Fuel bookkeeping & lifetime analysis
- Propulsion system sizing
- Launch window analysis
- Sensitivity and Monte Carlo analysis
- Navigation data simulation
- Orbit determination
- Maneuver planning and calibration
- Maneuver Support and reconstruction
- End-of-Life modelling
- Ephemeris prediction

System Characteristics

- World-class quality software
 - TRL 9, Class B, (Part of Center-wide CMMI Accreditation)
 - Over 16,000+ automated script **and GUI** tests
- Large system with extensible design
 - 540k C++ LOC Core
 - Script, GUI, and plugin interfaces
 - 2 Interfaces to external systems (MATLAB and Python (under development))
 - 890k LOC from other libraries (SNOPT (Stanford Business Software), SPICE (JPL NAIF), Wx-Widgets, VF13ad (Harwell), TSPlot Plotting Package (Thinking Systems, Inc.), Mars-GRAM model (MSFC))
- Enterprise level support
 - Large online support site (wiki, forums, issue tracker, downloads, etc)
 - Extensive Documentation (~1000 page User Guide and Reference Manual and ~100 pages of step-by-step tutorials)
 - Training (full-day live training courses and recorded training available via YouTube channel)

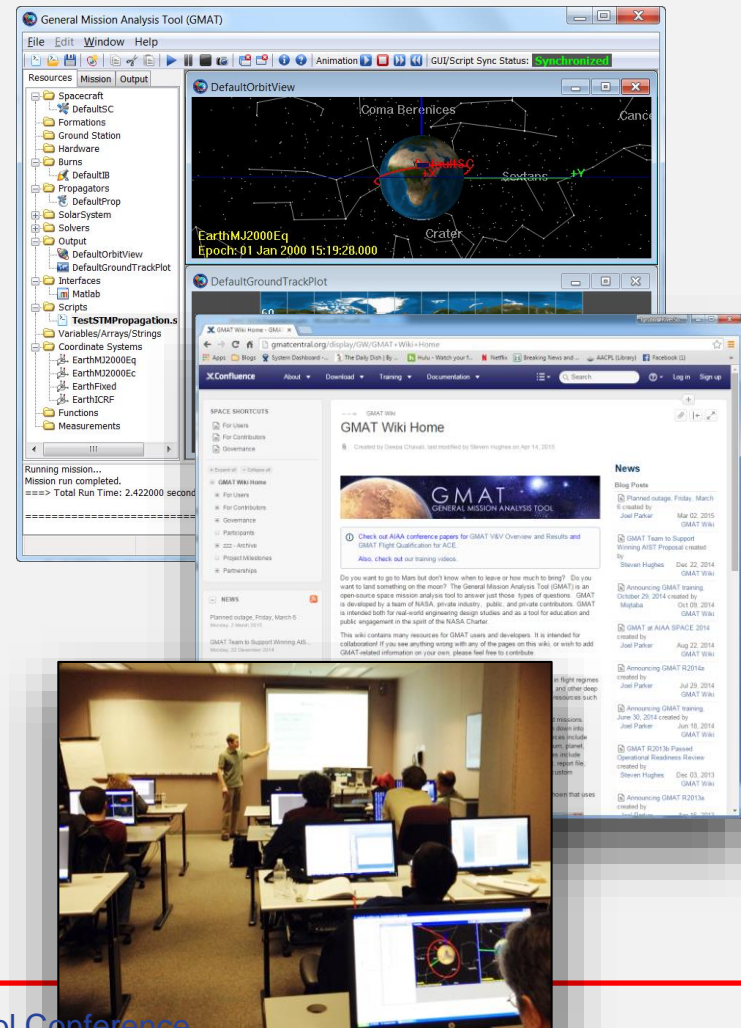

Usage Summary

- 9 NASA missions
- 5+ Discovery proposal efforts
- 15 domestic and international universities
- 6 OGAs
- 12 contributing commercial firms
- 13 commercial firms using in open literature
- 30+ independent peer reviewed publications citing analysis performed using GMAT

GMAT is used
world-wide



European Space Agency





**KEY
CONCEPTS**



GMAT

OrbitView Window

Ground Track Window

Graphics Window

Menu Bar

Toolbar

Resources Tab

Mission Tab

Output Tab

Resources Tree

Message Window

Status Bar

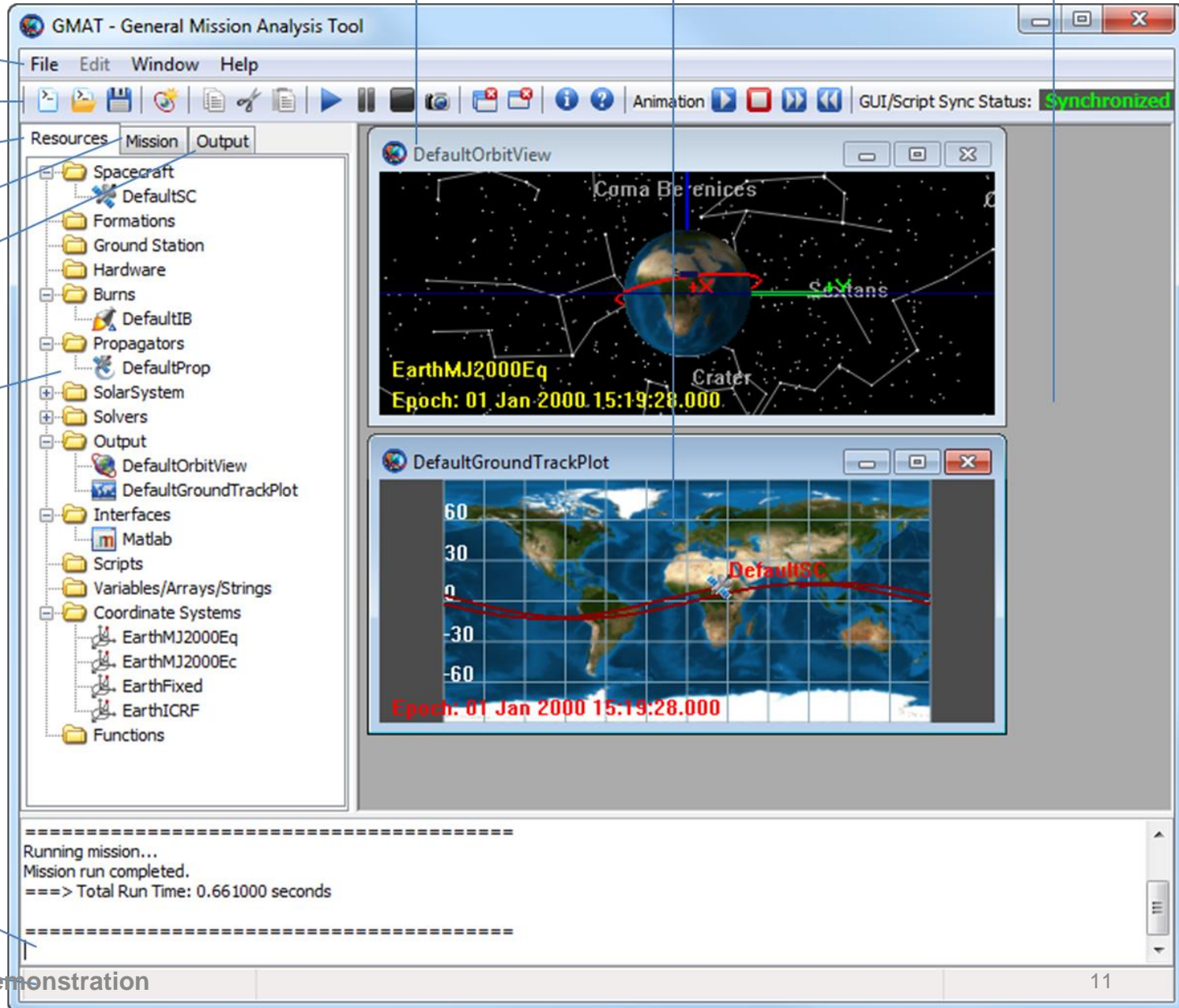

Execution Model

- GMAT is like MATLAB:
 - You write a program (a “mission”), then run it to generate output
- Not like Excel
 - Cannot generate output or manipulate results without rerunning

Execution Model (Cont'd)

- Batch execution model

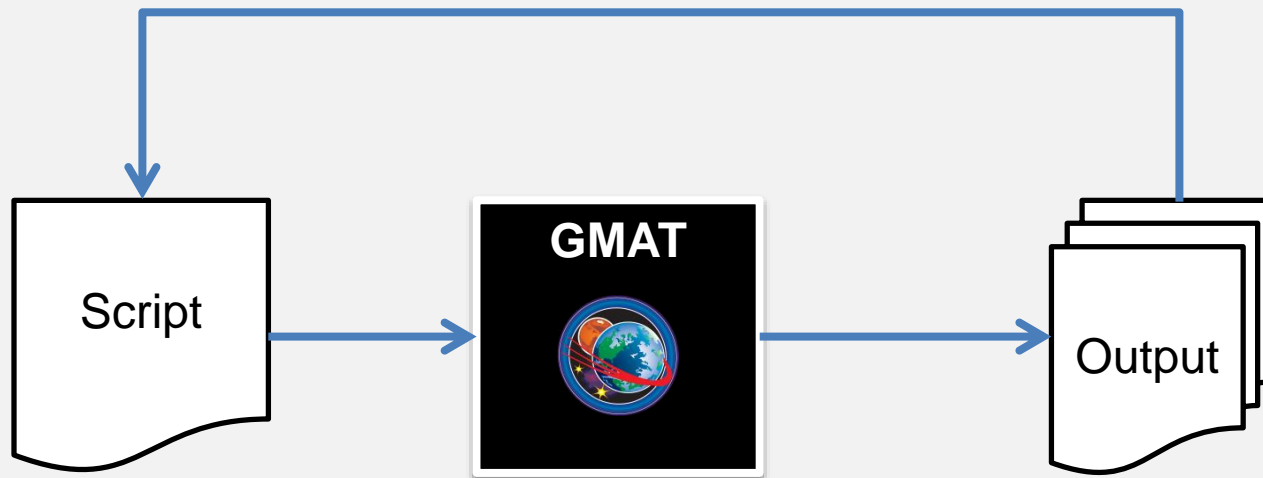

Two Parallel Interfaces

GUI

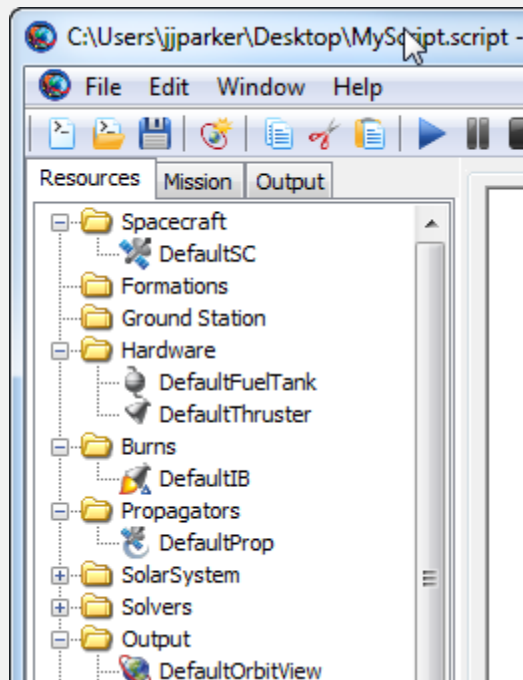

Script

```
1 %General Mission Analysis Tool (GMAT) Script
2 %Created: 2013-01-23 09:47:07
3
4
5 %-----
6 %----- Spacecraft
7 %-----
8
9 Create Spacecraft DefaultSC;
10 GMAT DefaultSC.DateFormat = TAIModJulian;
11 GMAT DefaultSC.Epoch = '21545';
12 GMAT DefaultSC.CoordinateSystem = EarthMJ2000Eq;
13 GMAT DefaultSC.DisplayStateType = Cartesian;
14 GMAT DefaultSC.X = 7100;
15 GMAT DefaultSC.Y = 0;
16 GMAT DefaultSC.Z = 1300;
17 GMAT DefaultSC.VX = 0;|
18 GMAT DefaultSC.VY = 7.35;
19 GMAT DefaultSC.VZ = 1;
20 GMAT DefaultSC.DryMass = 850;
21 GMAT DefaultSC.Cd = 2.2;
```

GUI and script are nearly interchangeable (but not totally).

Resources and Commands

Resources

- Participants in a GMAT mission
- Represent the “things” that will be manipulated
- Think of them as objects, with properties
- Most are “fixed” when the mission starts

Commands

- Events in a GMAT mission
- Represent the actions taken on the resources
- Think of them as methods or functions

Fields and Parameters

Fields

- Properties you can set on a resource
- Examples:
 - `Spacecraft.Epoch`
 - `Thruster.DecrementMass`
 - `ReportFile.FileName`

Parameters

- Properties you can calculate during the mission
- Parameters often have dependencies
- Examples:
 - `Spacecraft.Earth.Altitude`
 - `Spacecraft.EarthMJ2000Eq.BVectorAngle`
- Sometimes a property is both a field and a parameter.
 - Examples: `Spacecraft.SMA`, `FuelTank.FuelMass`



TOUR OF THE GRAPHICAL USER INTERFACE

GMAT

Resource Tree

- Contains all configured resources in the mission
- Grouped into folders by type:
 - Spacecraft
 - Hardware
 - Burns
 - Output
 - SolarSystem

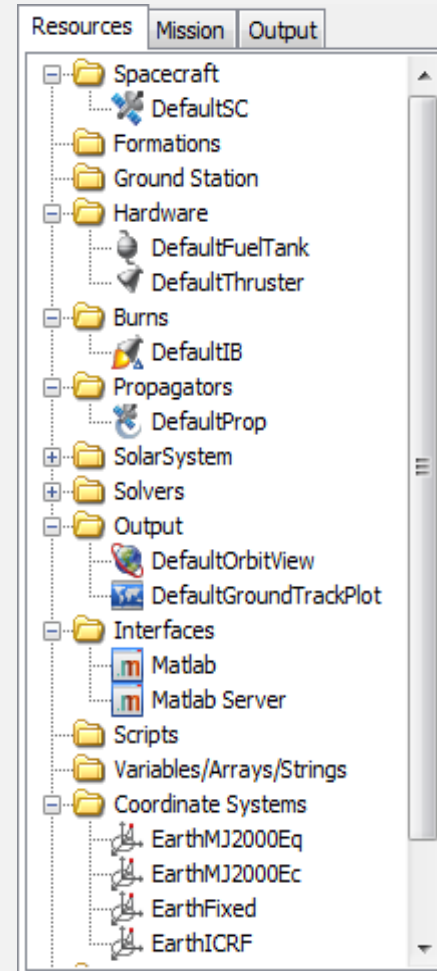

Mission Tree

- Contains the Mission Sequence—sequence of all configured commands
- Special features:
 - Docking & undocking
 - Filtering controls
 - Command Summary

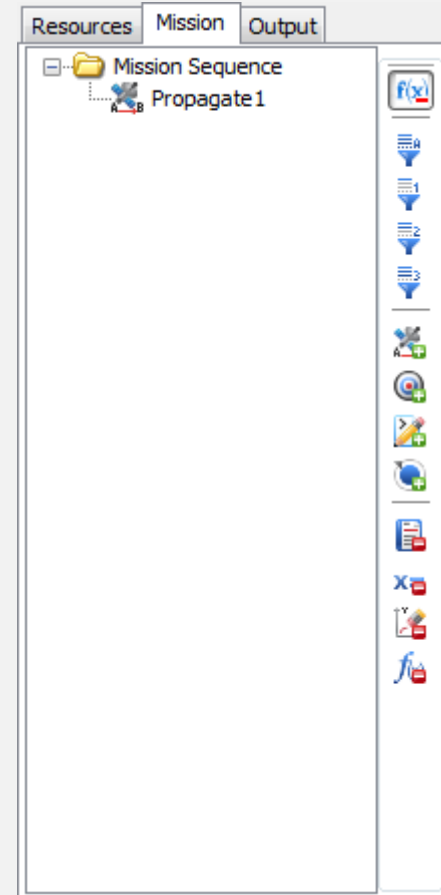

Output Tree

- Contains all output products
- Populated *after* mission execution

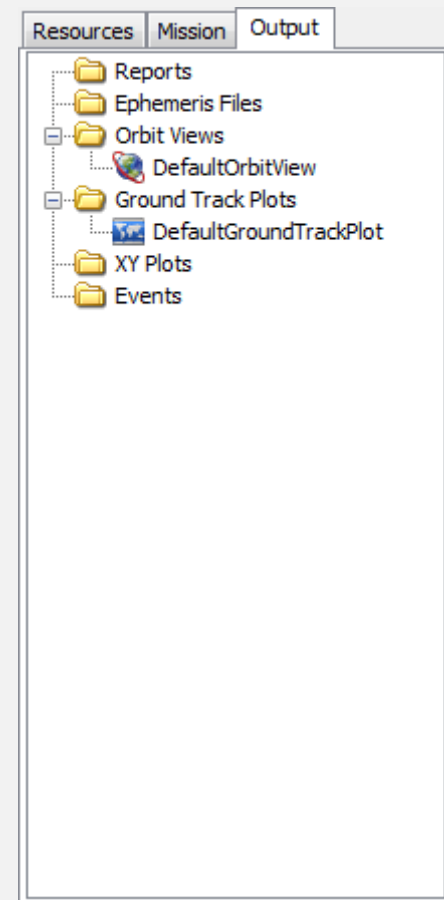

OrbitView

- 3D graphics window
- Most complex of the graphical output types
 - Others include: XYPlot (2D plotting), GroundTrackPlot (2D mapping)
- Mouse controls:
 - Left button: rotation
 - Right button: zoom (horizontal motion)
 - Middle button: rotation normal to screen
- Configuration includes:
 - Camera controls
 - Resources to draw
 - Visual elements



TOUR OF THE SCRIPT LANGUAGE

GMAT

Basic Syntax

- Syntax is based on MATLAB
- Single-line statements w/ optional line continuations
- Case sensitive
- Loosely typed
- Begin/End block statements
- Resources are created before used (except special defaults like SolarSystem)

Basic Syntax

- Script is divided into two sections:
 - Initialization (at the top)
 - Mission Sequence (at the bottom)
 - Divided by the `BeginMissionSequence` command
- Initialization -> Resources Tree
 - Static assignment only
- Mission Sequence -> Mission Tree
 - Manipulation of existing resources, cannot create new ones

Basic Syntax

```
Create Spacecraft sat  
sat.SMA = 7000
```

```
Create ReportFile r  
r.FileName = 'MyReport.txt'
```

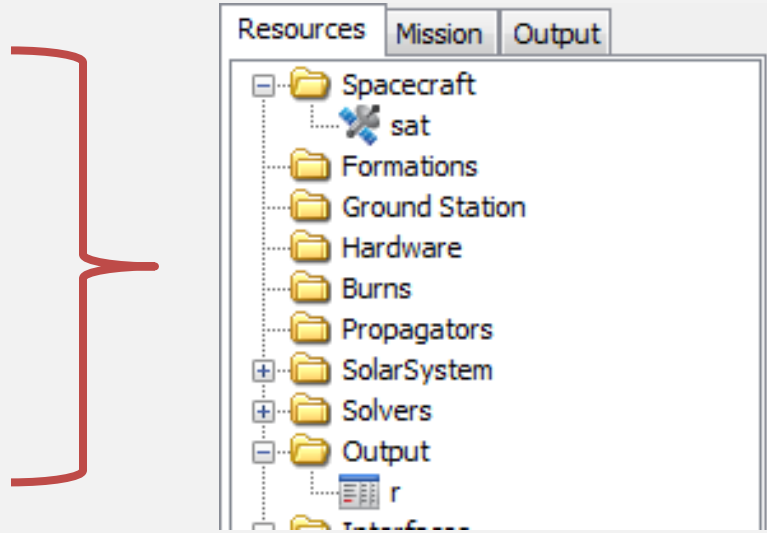

```
BeginMissionSequence
```

```
Report 'Write SMA' r sat.SMA
```

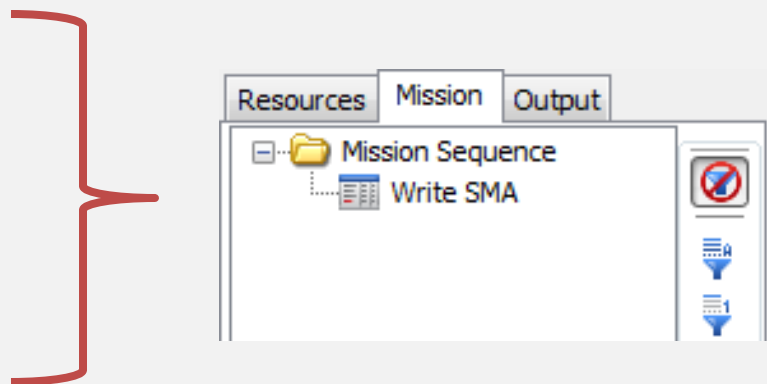

Using Math

- Math syntax is based on MATLAB
- Operators are matrix-aware

Operators	
+	add
-	subtract
*	multiply
/	divide
'	transpose
^	power

Built-in Functions	
sin	cos
tan	asin
acos	atan
atan2	log
log10	exp
DegToRad	RadToDeg
abs	sqrt
norm	det
inv	

Using Math

```
Create Spacecraft SC
```

```
SC.SMA = 7100
```

```
Create Variable period, mu, pi
```

```
mu = 398600.4415
```

```
BeginMissionSequence
```

```
pi = acos(-1)
```

```
period = 2 * pi * sqrt(SC.SMA^3/mu)
```

Using Parameters

- Parameters can have one of two types of dependencies (or neither):
 - Central body
 - Coordinate system
- They are calculated on the fly when they are used:
 - `Spacecraft.MarsFixed.X`
 - `Spacecraft.Earth.BetaAngle`
- If omitted, default dependency is used

Using Parameters

```
Create Spacecraft SC
SC.CoordinateSystem = MarsFixed
Create ReportFile r
BeginMissionSequence

% using parameters
Report r SC.EarthMJ2000Eq.X
Report r SC.Earth.BetaAngle
```

Control Flow

- Three control flow statements:
 - If/Else – execute if a conditional is true
 - While – loop while a condition is true
 - For – loop a certain number of times

```
If SC.Earth.Altitude < 300
    % do a maneuver
Else
    % continue
EndIf
```

Solvers

- Three types of solvers:
 - Targeter (using Differential Corrector)
 - Optimizers (using either optimizer)
 - Estimator (using Batch Estimator and, soon, EKF)
- Similar to loops, with specific nested commands:
 - Target: Vary, Achieve
 - Optimize: Vary, NonlinearConstraint, Minimize
- See the tutorials for examples

Live Demonstration

- Performing a Hohmann Transfer



**DISCUSSION
AND
QUESTIONS**

GMAT



General Mission Analysis Tool (GMAT)

GMAT Application to GSFC Mission Design

Steven P. Hughes

08 Feb. 2016

This presentation is based on presentations provided by the TESS project and used with their permission. Author attributions are listed throughout.

1. Mission Overview
2. Requirements
3. Trajectory Design Process
4. Other Areas
 1. *Solution Generation Process*
 2. *Finite Burn Modeling*
 3. *Launch Vehicle Dispersion Analysis*
 4. *Maneuver Planning*
 5. *Launch Window Analysis*
 6. *Conclusions*

A blue bracket on the right side of the slide groups the sub-items under 'Other Areas'.

We won't have time to discuss these but all of these activities were performed in GMAT

NOTE: This is a snapshot from TESS PDR and some details have changed.

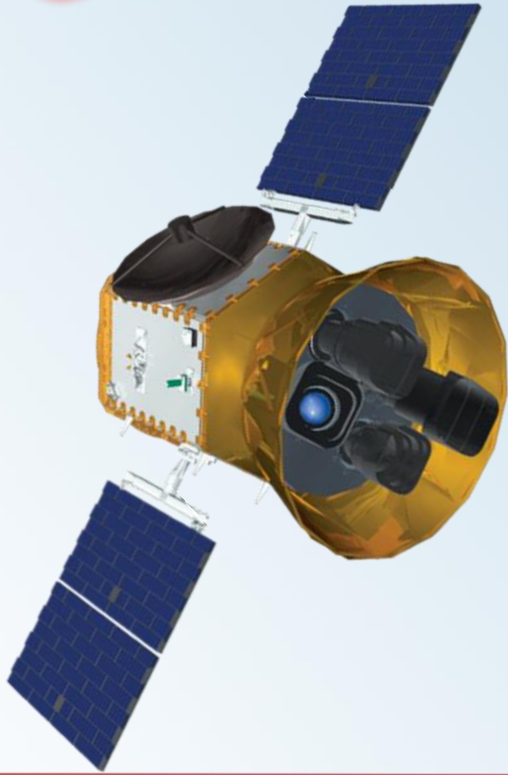

01: Mission Overview

TESS Mission Design Pre-CDR Peer Review

Joel Parker

March 11, 2015

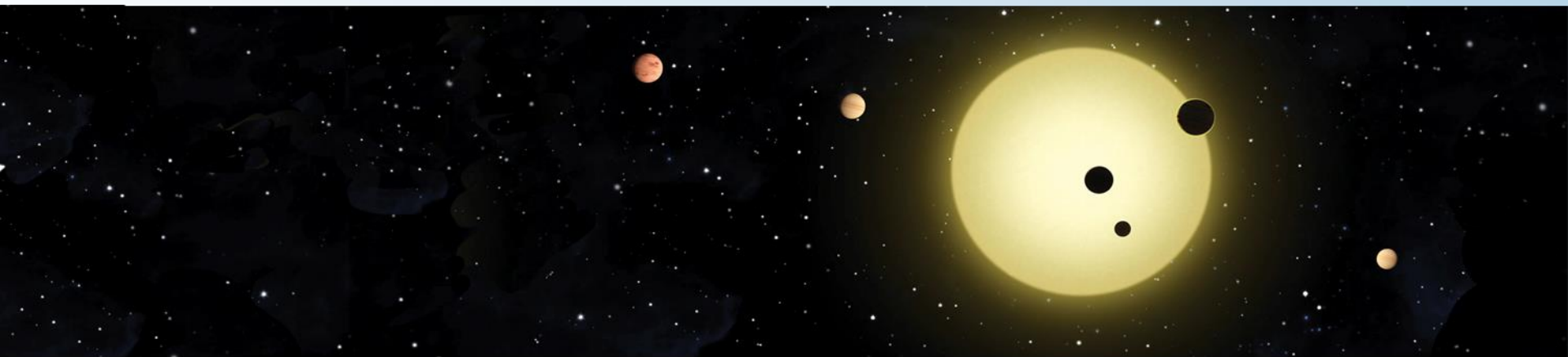

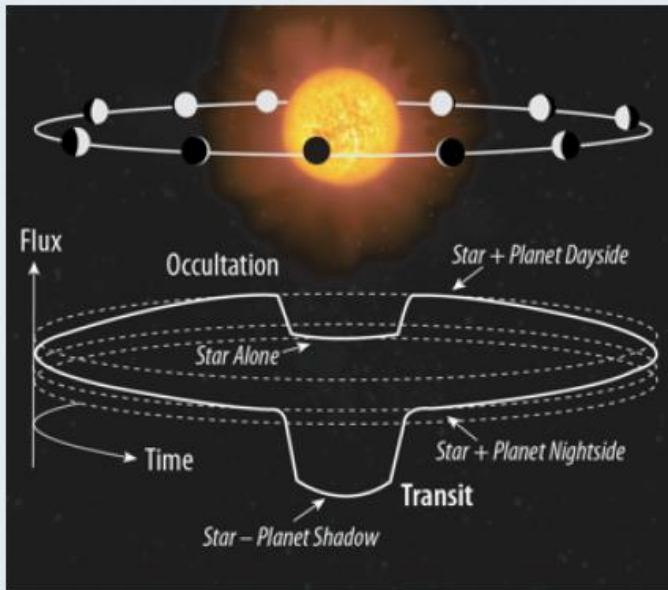

- ◆ **Primary Goal:** Discover Transiting Earths and Super-Earths Orbiting Bright, Nearby Stars
 - *Rocky Planets & Water Worlds*
 - *Habitable Planets*
- ◆ Discover the “Best” ~1000 **Small** Exoplanets
 - “Best” Means “Readily Characterizable”
 - *Bright Host Stars*
 - *Measurable Mass & Atmospheric Properties*
 - Present: Only 3 small transiting exoplanets orbiting bright hosts are known

◆ Large Area Survey of Bright Stars

- *F, G, K dwarfs: +4 to +12 magnitude*
- *M dwarfs known within ~60 parsecs*
- “All sky” observations in 2 years:
 - *> 200,000 target stars at <2 min cadence*
 - *> 20,000,000 stars in full frames at 30 min cadence*

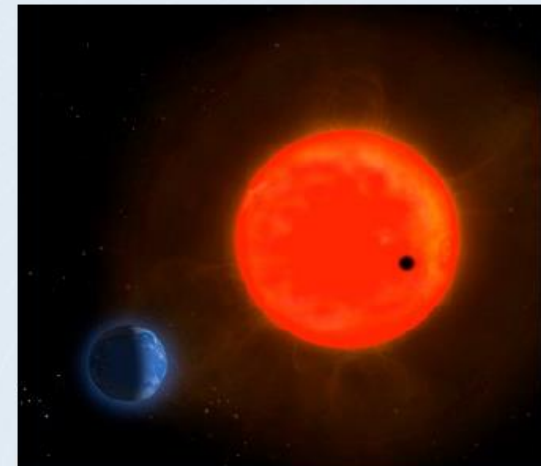

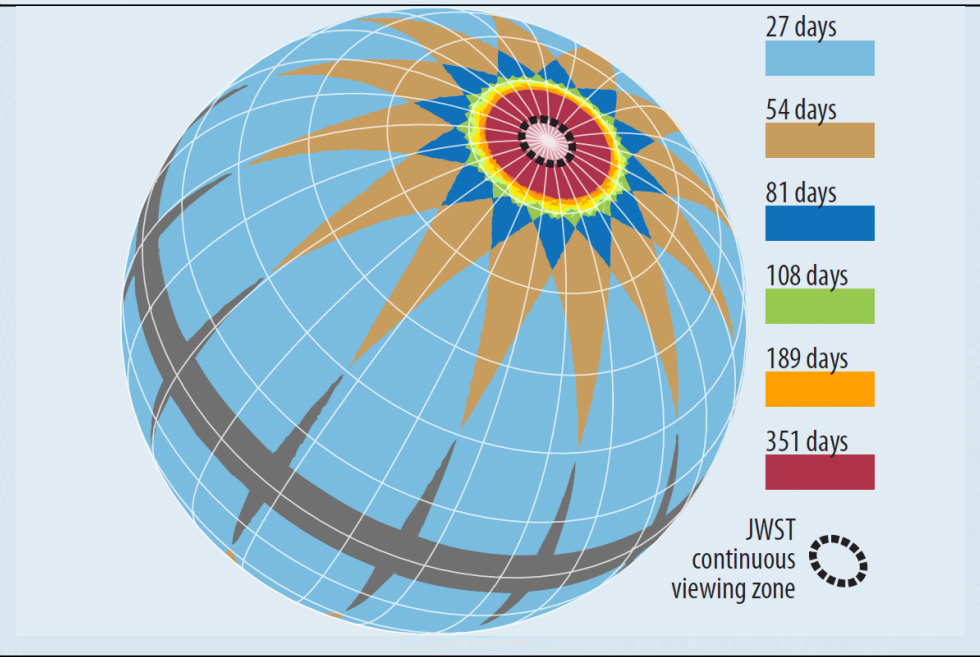
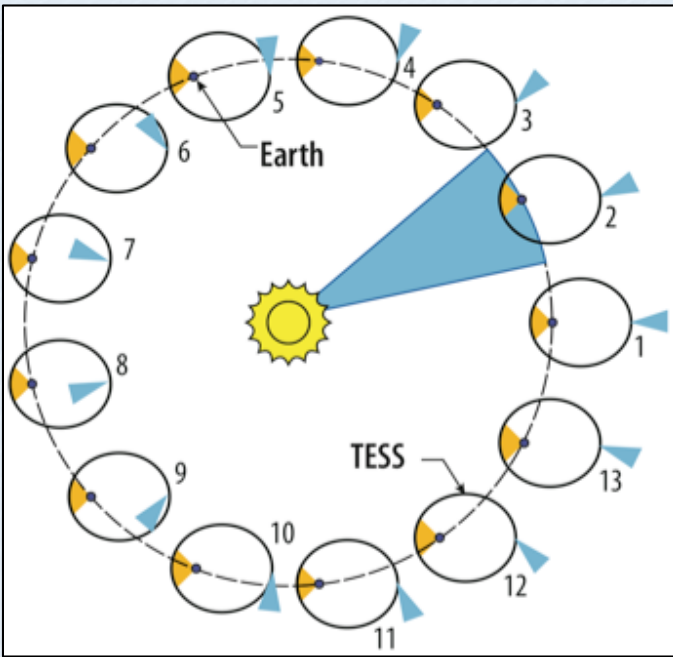

Anti-Solar segments drive +/- 15 deg

Coverage of ecliptic poles drives Pitch angle (nominally 54 deg)

- Concentration of coverage at the ecliptic poles for JWST.
- Sacrifice of coverage in the ecliptic because Kepler-2 is already mapping that region.

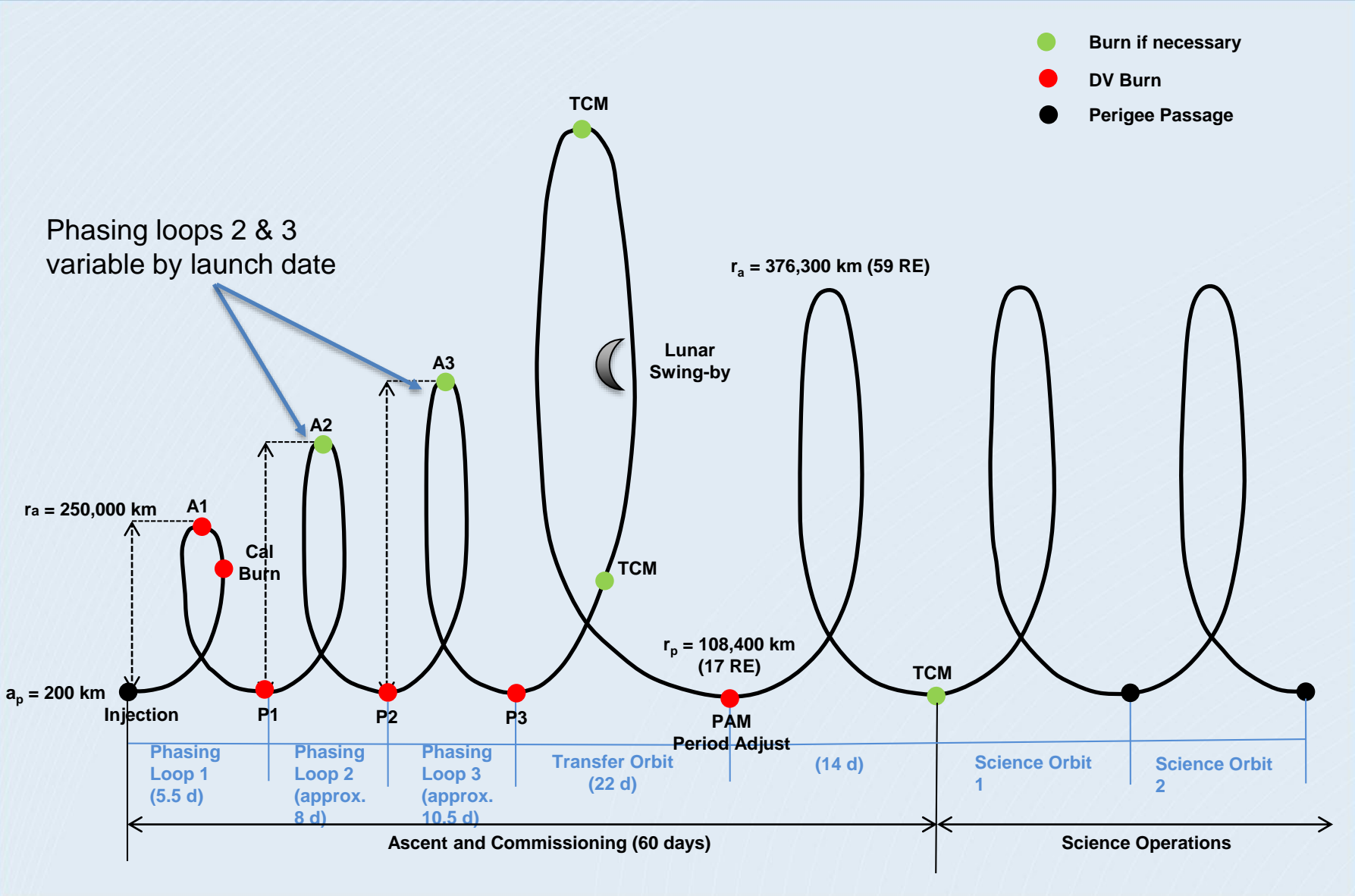

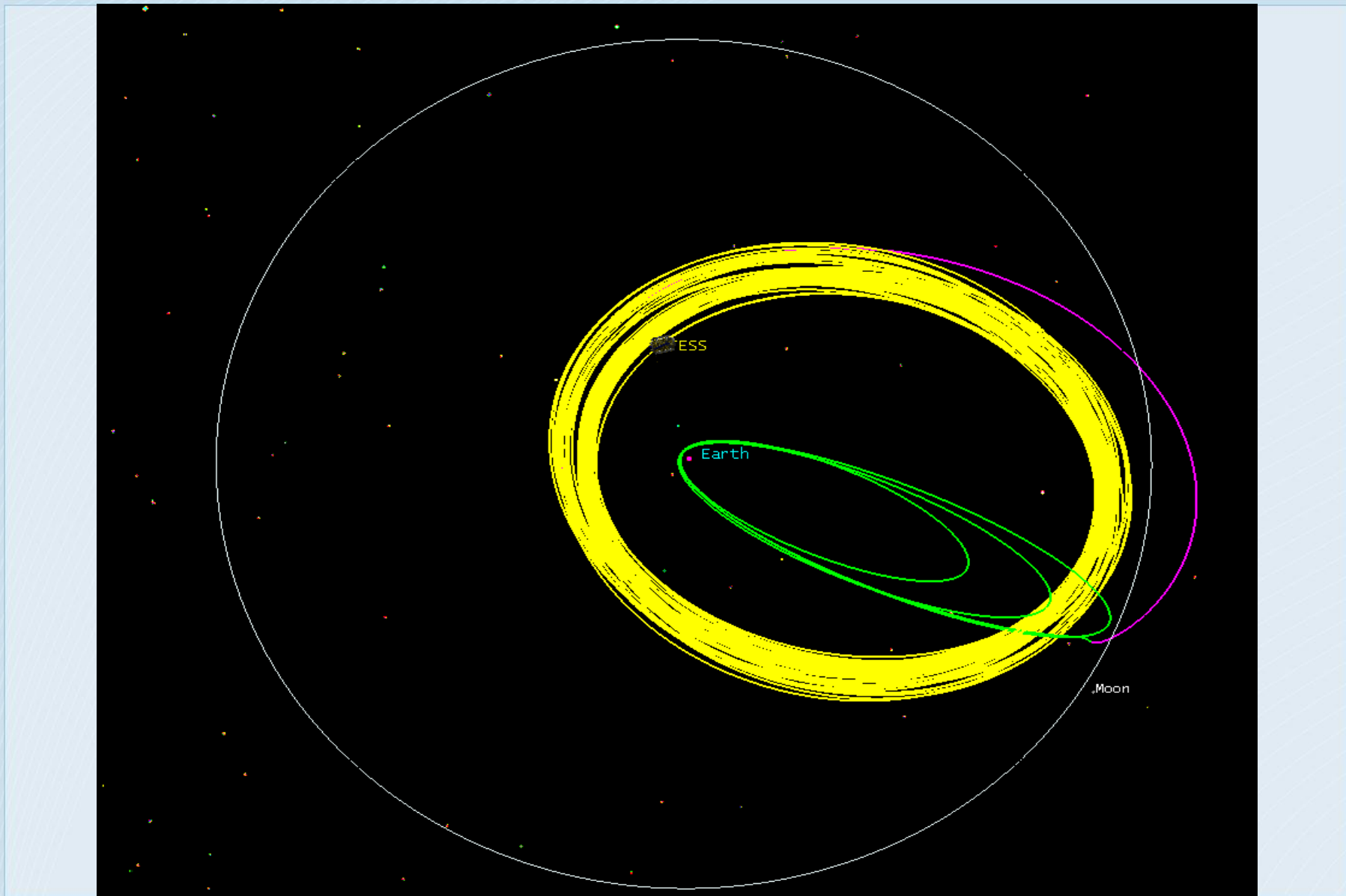

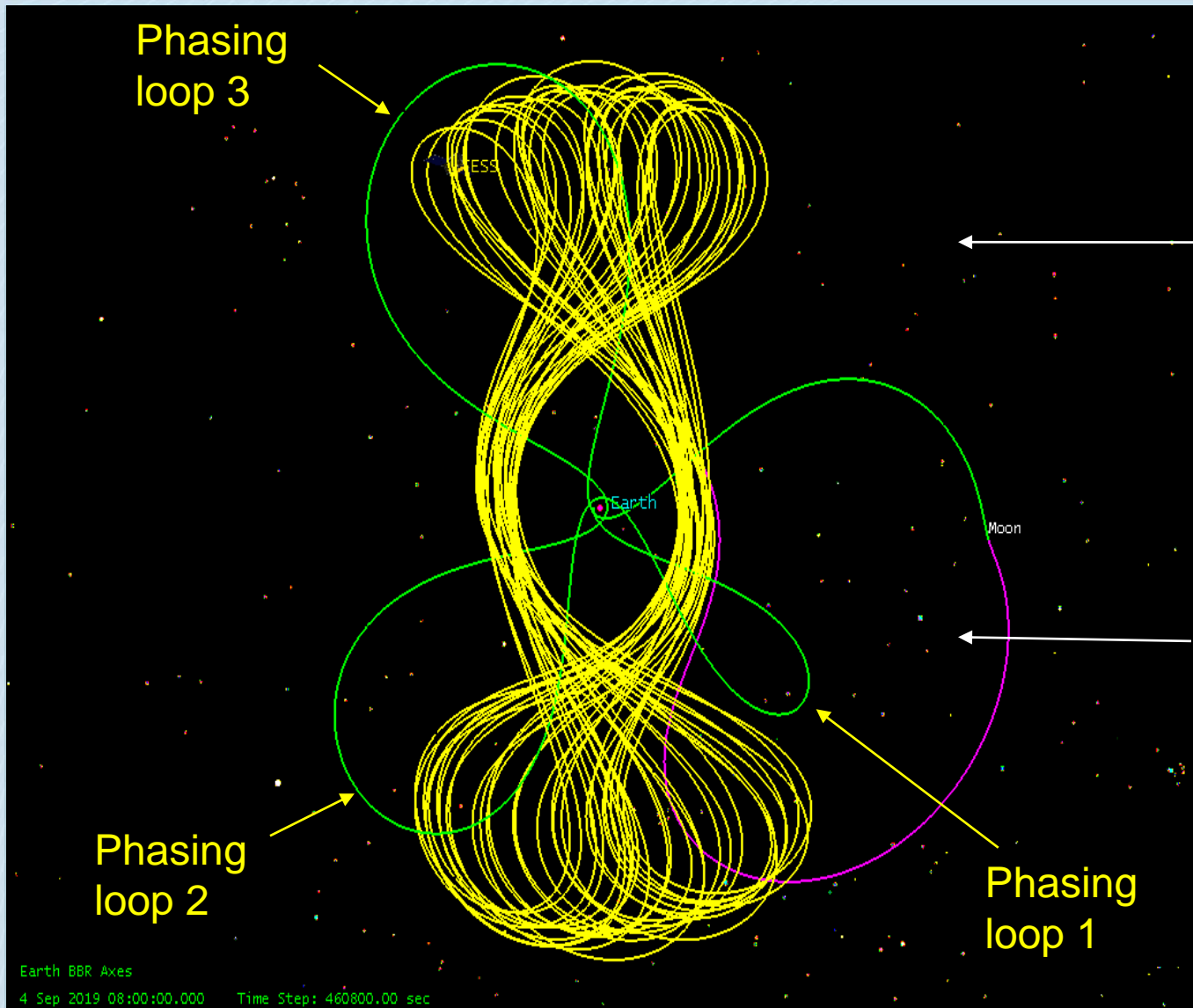

For a loop in the 1st quadrant, the Moon is behind and lowers perigee

For a loop in the 4th quadrant, the Moon is ahead and raises perigee

Earth BBR Axes
4 Sep 2019 08:00:00.000 Time Step: 460800.00 sec

Roughly 47 degree plane change at flyby

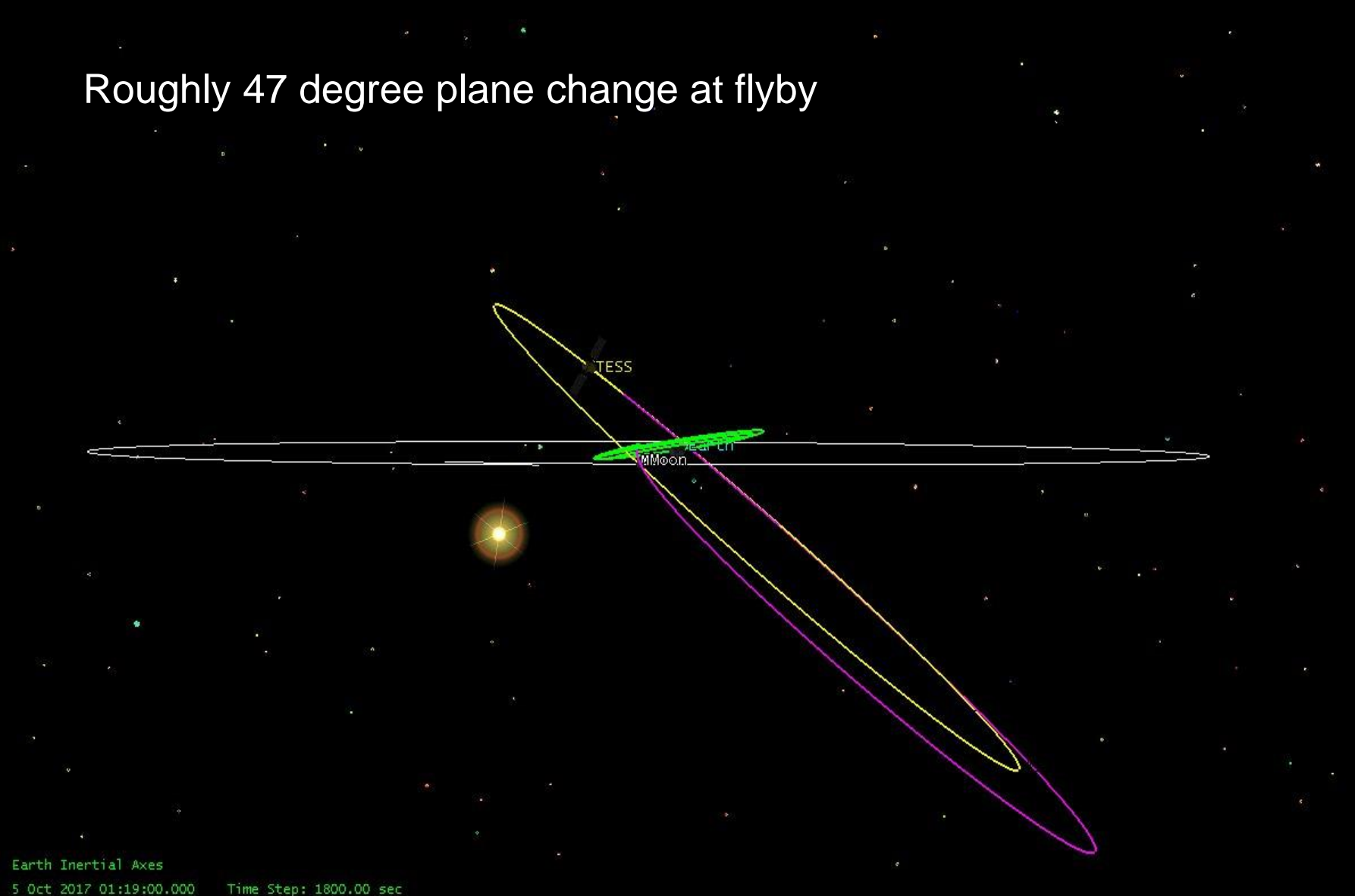

ID	Title	Requirement Summary
MRD_2	Mission Life	2-year mission + 2-month commissioning
MRD_10	Observation Period	HASO duration ≥ 12.5 days per orbit
MRD_54	Launch Period	Launch opportunities on at least 5 days days per lunar cycle
MRD_55	Launch Window	30-Second Launch window
MRD_42	Ascent and Commissioning Duration	Achieve mission orbit within 2 months after launch
MRD_51	Mission Orbit	2:1 lunar-resonant orbit
MRD_52	Maximum Range in LAHO	Perigee < 22 Re
MRD_101	Mission Maximum Range	Apogee < 90 Re
MRD_53	Avoidance of Geosynchronous Orbit	Orbit does not intersect GEO band for mission + 100 years (TBD)
MRD_56	Eclipse Frequency and Duration	No eclipses longer than 5 hours and not to exceed 14 in number (duration = umbra + 0.5*penumbra)
MRD_104	Delta-V Allocation	Total $\Delta V \leq 215$ m/s (99% probability)
MRD_129	Longest Single Maneuver	Longest continuous maneuver ≤ 95 m/s
MRD_85	Sun in Instrument Boresight	FOV exclusion of $54^\circ \times 126^\circ$ (TBR) for 15 minutes (TBR)
MRD_64	Missed Maneuver	Achieve mission orbit w/ any single missed/aborted maneuver. (Deleted)

Green Requirements are Orbit Design Drivers

Consistent with EXP-TESS-GSFC-RQMT-0001 Rev B

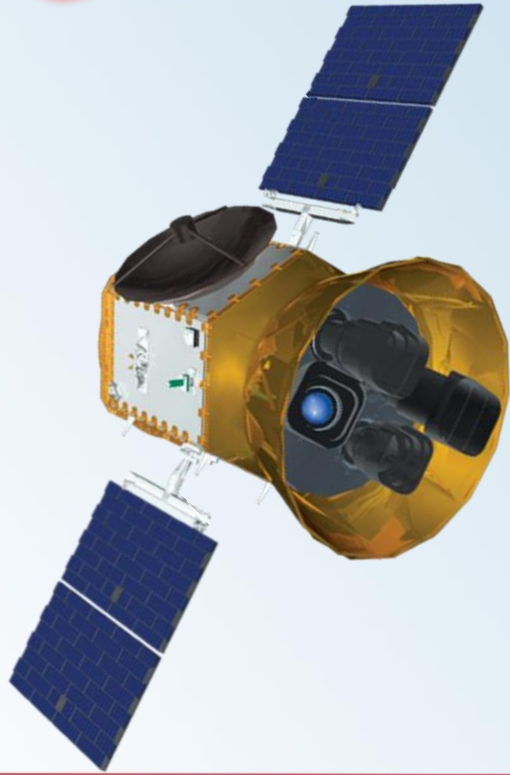

03: Trajectory Design Process

TESS Mission Design Pre-CDR Peer Review

Joel Parker

March 11, 2015

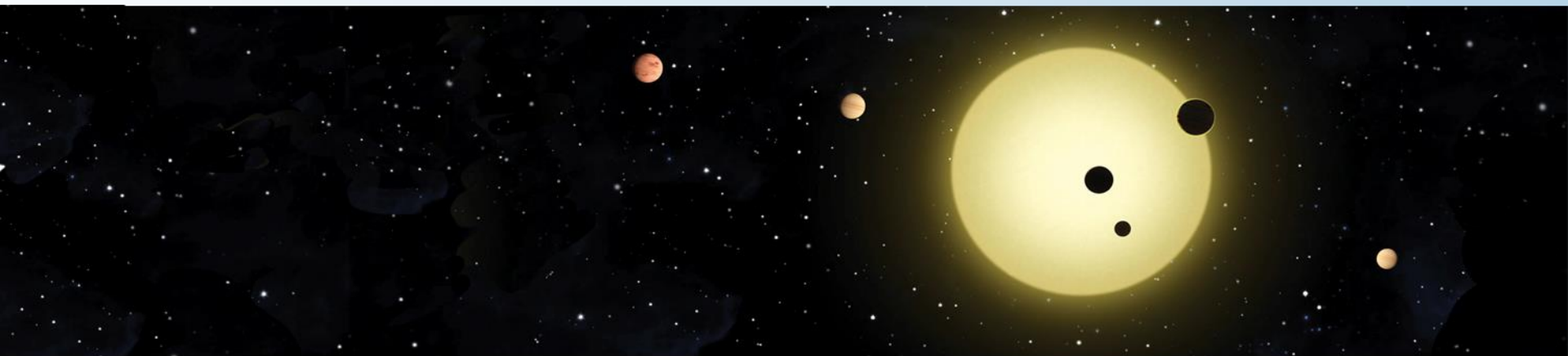

The TESS trajectory design process is based on three components:

- ◆ Theoretical basis
 - *Kozai constant*
 - *Tisserand condition*

- ◆ Two-body patched-conic first guess
 - *Implementation of theory to approximate final trajectory*

- ◆ High-fidelity targeting
 - *Transitions approximate first guess to realistic final solution*

- ◆ General Mission Analysis Tool (GMAT) used for implementation of design
 - *GSFC's in-house high-fidelity trajectory design software*
- ◆ Uses first guess to seed numerical targeting algorithm

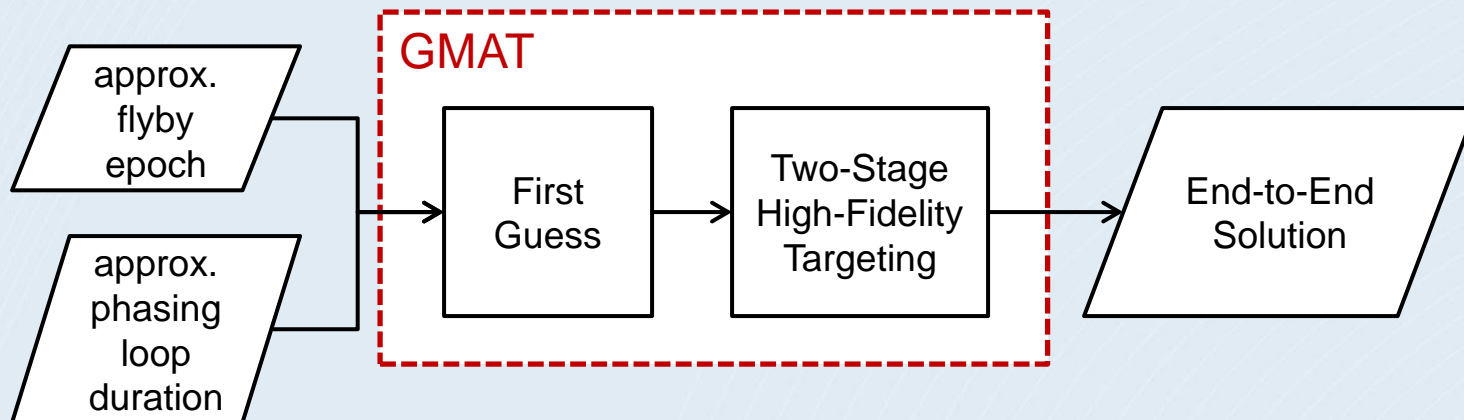

- ◆ Two targeting stages
- ◆ Stage 1: Design from Translunar Injection (TLI) through flyby to Science Orbit
 - *Multiple-shooting process*
 - *Starts with patched-conic first guess*

- ◆ Stage 2: Backwards design from converged mission orbit to launch vehicle separation (adding phasing loops)
 - *Single-shooting process*
 - *Starts with converged outbound solution + 2-body phasing loops guess*

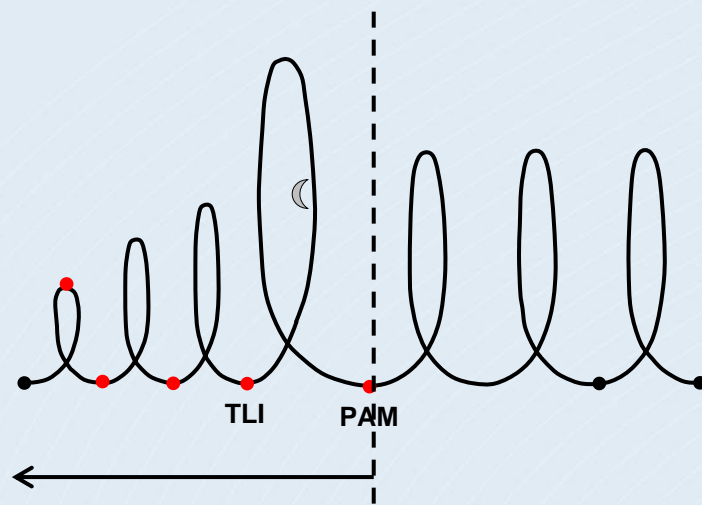
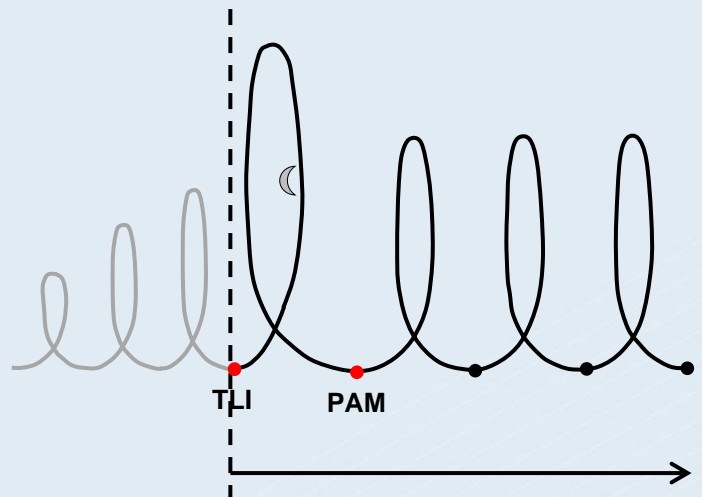

- ◆ Multiple-shooting approach w/ 5 segments

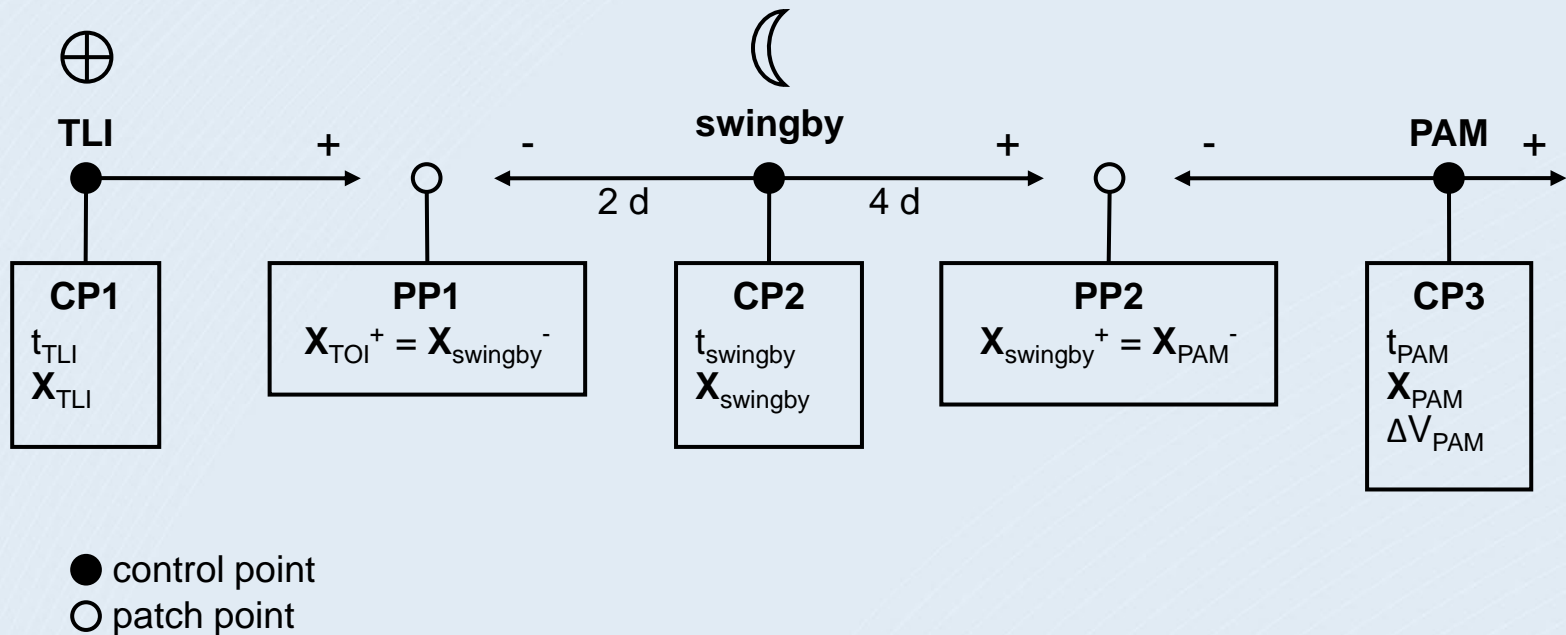

- ◆ Start with patched-conic initial guess for each segment
- ◆ GMAT targeting sequence used to find smooth solution from segmented initial guess

- ◆ General Mission Analysis Tool (GMAT) used for implementation of design
 - *GSFC's in-house high-fidelity trajectory design software*
- ◆ Uses first guess to seed numerical targeting algorithm

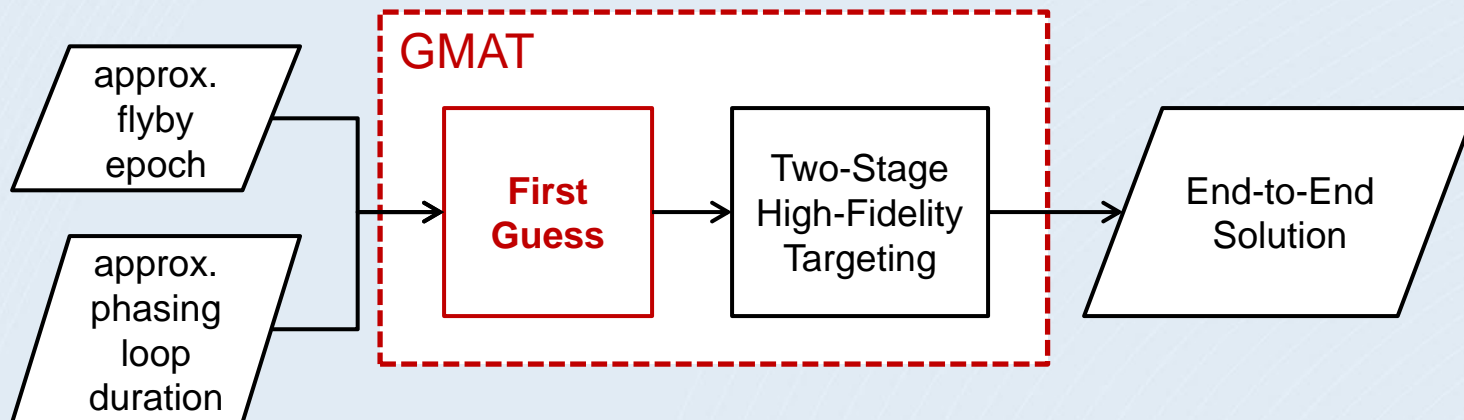

- ◆ The TESS trajectory has two critical features:
 - *Transfer orbit (result of lunar flyby)*
 - *2:1 lunar resonant mission orbit*

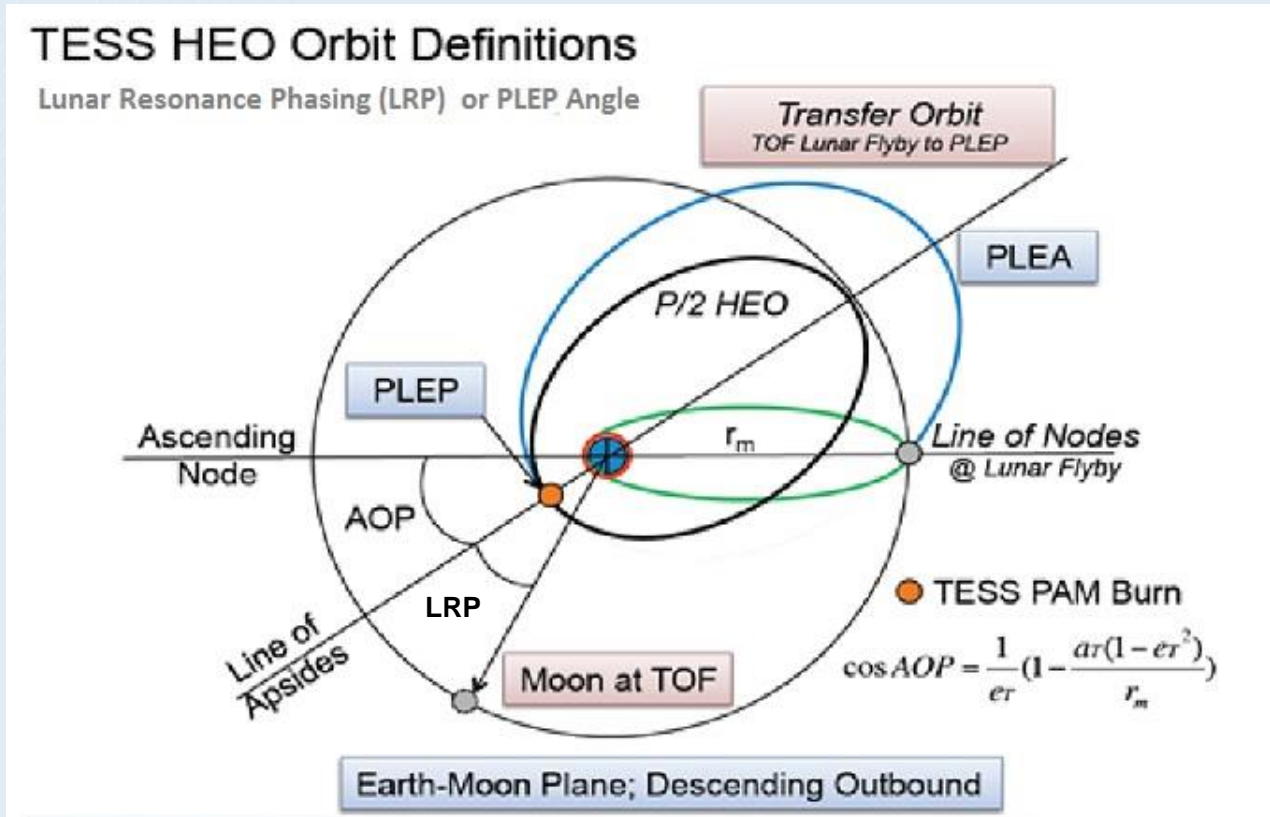

- ◆ The Tisserand criterion holds that a quantity T is constant before and after a flyby:

$$T = \frac{1}{2a} + \cos(i) \sqrt{a(1 - e^2)}$$

- ◆ Here a is semimajor axis (scaled by distance between the primary bodies), e is eccentricity and i is inclination to the orbit plane of the primaries
- ◆ The Tisserand criterion is used for TESS to design the lunar flyby.
 - *We choose the value of T to obtain the desired orbit properties of the transfer orbit after flyby to mission orbit.*
 - *The transfer orbit shape is driven by a timing condition: the need for the spacecraft at Post Lunar Encounter Perigee (PLEP) to nearly line up with the Moon. The spacecraft-Earth-Moon angle at perigee is called PLEP misalignment or the Lunar Resonant Phase Angle.*
 - *We then use the value of T to infer the shape of the orbit before flyby*

- ◆ The Kozai Mechanism describes the long-term evolution of a highly eccentric, highly inclined orbit due to a third body (Moon).
- ◆ The Kozai model implies that:
 - *Orbit semimajor axis is conserved*
 - *Kozai parameter $K = \cos(i)\sqrt{1 - e^2}$ is constant, where e is eccentricity and i is inclination to the Moon orbit plane*
- ◆ Kozai mechanism predicts
 - *Eccentricity and inclination oscillate in unison, with a period of about 8 years for a TESS-like orbit. (Therefore, perigee radius and inclination oscillate together.)*
 - *AOP relative to the Moon librates around 90 deg or 270 deg, if the initial inclination is higher than critical inclination 39.2 deg*

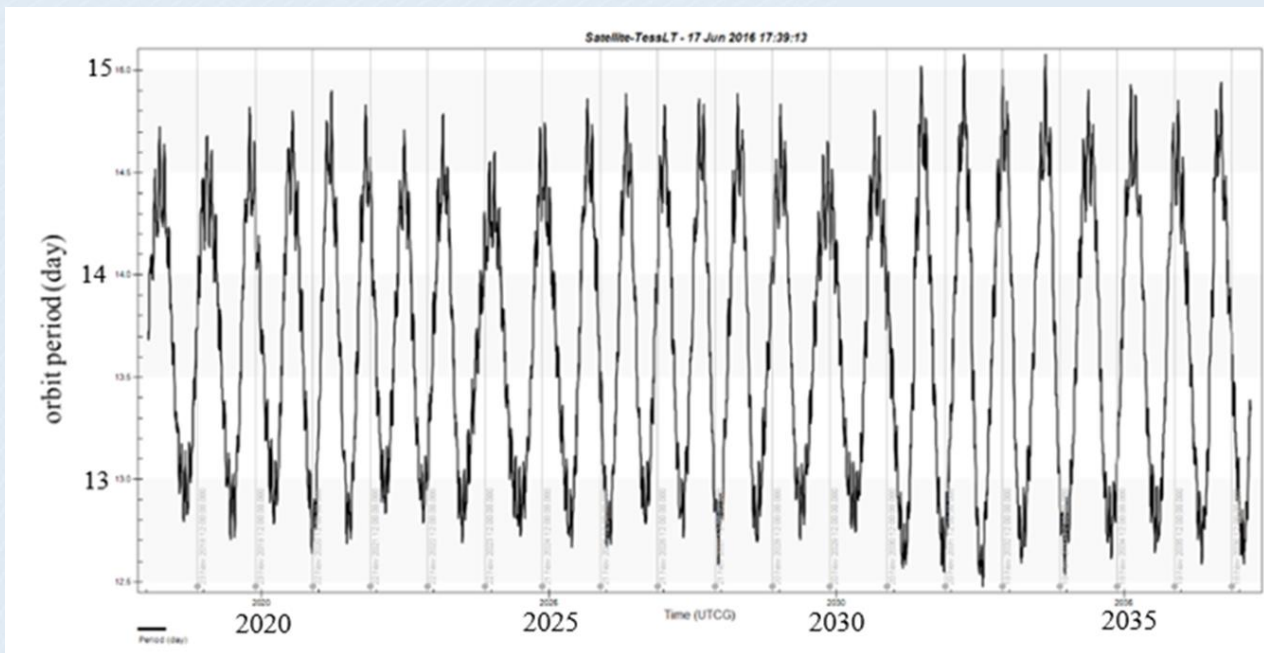

- Orbit period oscillates around ideal 13.65 days with amplitude near 1 day
- Thus we do not need to start at ideal resonance to achieve resonance on average
 - We change mission orbit period by changing the Period Adjust Maneuver (PAM) at mission orbit insertion
- IBEX extended mission design used this feature to select an initial orbit that achieved low eclipse durations for several years

- ◆ Kozai mechanism is relevant to TESS because
 - *We want mission perigee radius to remain between 6.6 Re (GEO) and 22 Re*
 - *We want mission ecliptic AOP to remain near 90 deg or 270 deg, so line of apsides stays out of ecliptic plane, and so long eclipses cannot occur near apogee*
- ◆ For TESS orbit, $e = 0.55$ so $K = 0.65$ implies $i = 39$ deg
- ◆ We exploit the fact that the lunar plane and ecliptic plane are near the same, only 5 deg apart.
- ◆ Perturbing forces (**especially the Sun**) imply that the Kozai mechanism does not work exactly in the full force model. Nevertheless, like CR3BP, the Kozai mechanism is a useful technique for orbit design

Methods described by Aerospace Corp in CSR and flight dynamics paper “A High Earth, Lunar Resonant Orbit For Lower Cost Space Science Missions” by Gangestad, Henning, Persinger and Ricker (AAS 13-810)



Kozai Mechanism (cont'd)

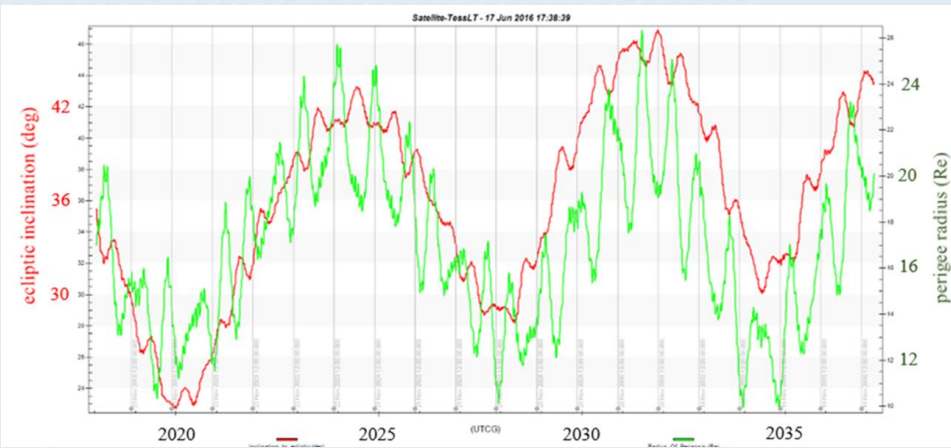

Evolution of perigee radius (green) and lunar inclination (red) over 20 years. The oscillation period is about 10 years

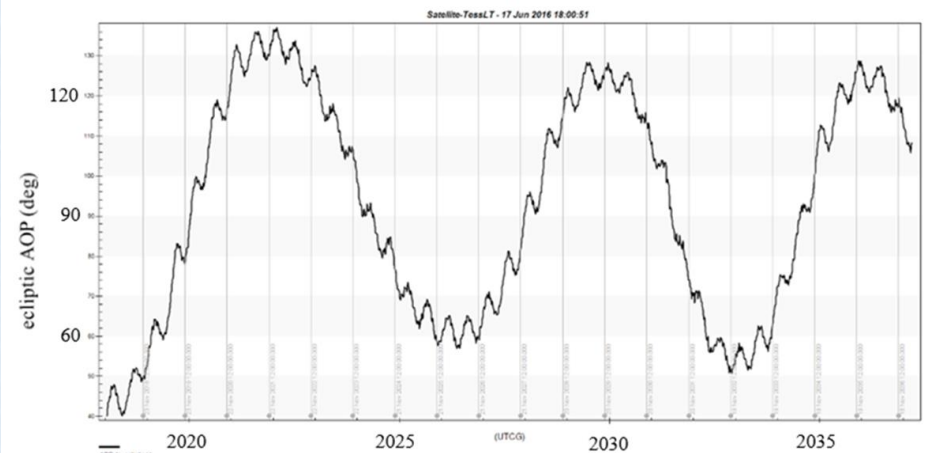

Evolution of ecliptic AOP over 20 years.

See also: Dichmann, Parker, Williams, Mendelsohn: Trajectory Design for the Transiting Exoplanet Survey Satellite. ISSFD 2014

- ◆ General Mission Analysis Tool (GMAT) used for implementation of design
 - *GSFC's in-house high-fidelity trajectory design software*
- ◆ Uses first guess to seed numerical targeting algorithm

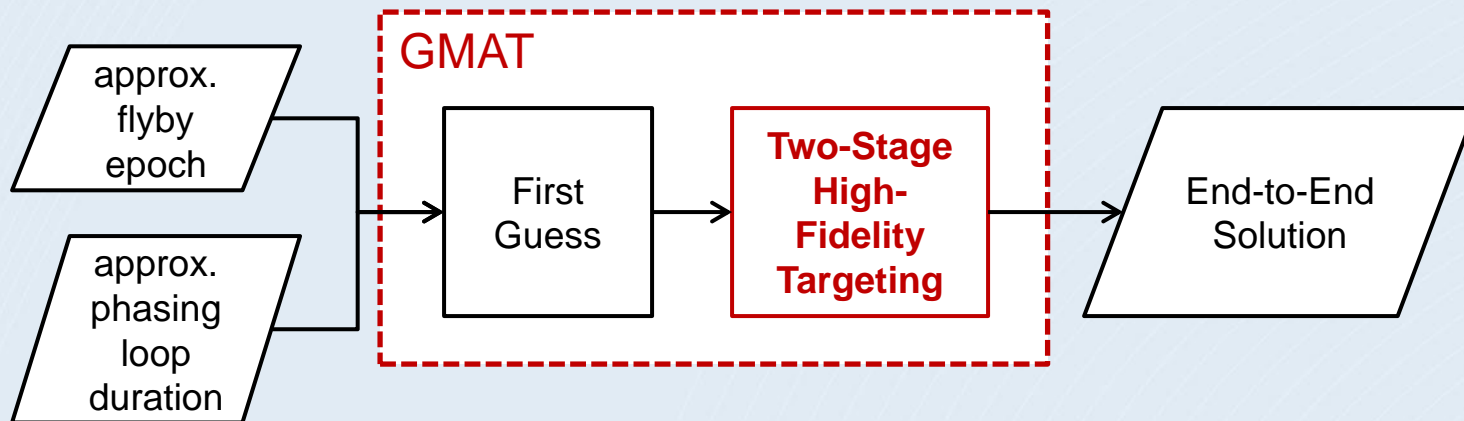

- ◆ Two targeting sequences
- ◆ Stage 1: Design from Translunar Injection (TLI) through flyby to Science Orbit
 - *Multiple-shooting process*
- ◆ Stage 2: Backwards design from converged mission orbit to launch vehicle separation (adding phasing loops)
 - *Single-shooting process*
 - *Starts with converged outbound solution + 2-body phasing loops guess*
- ◆ Both stages use VF13 NLP solver as robust targeter
 - *Seeks feasible solution only; not optimizing*
- ◆ Final 3rd stage: forward-propagation from SEP to check constraints

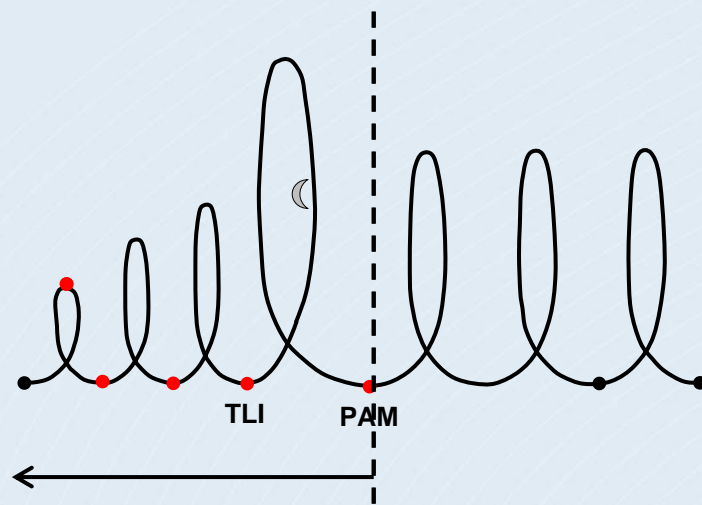
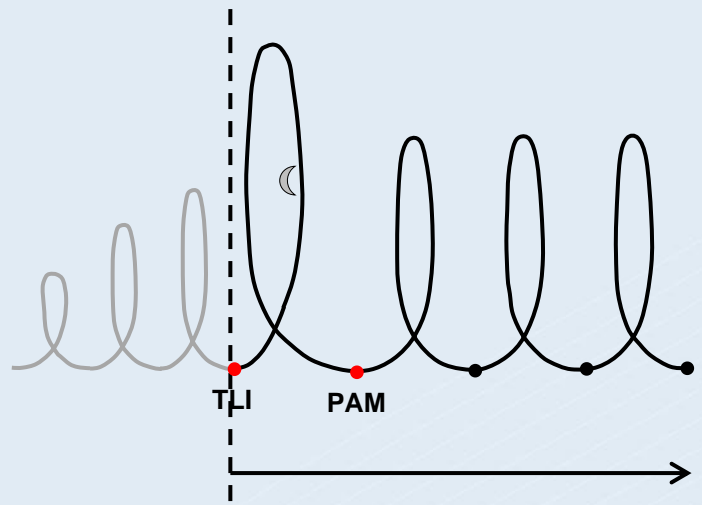

Change since PDR Peer Review

- ◆ All analyses share common force models, spacecraft parameters, solar system models, to the extent practical.

Spacecraft model	
Mass*	201.9 kg
Coeff. of reflectivity (SRP)	1.5
SRP area	3.5 m ²

*Low dry mass estimate, used to model worst-case SRP effect & kept for continuity. Current mass estimate is used in finite burn analysis.

Force modeling	Phasing loops	Flyby	Mission orbit	Solar system ephem
Central-body gravity	JGM-2 40×40	Moon point mass	JGM-2 8×8	DE421
Third-body gravity	Sun, Moon	Sun, Earth	Sun, Moon	
SRP	Enabled	Enabled	Enabled	
Drag	Disabled	Disabled	Disabled	

Parameter	Value	Description
TLI inclination	28.5°	Fixes TLI at approximate LV insertion inclination
TLI perigee altitude	600 km	Phasing loop perigee altitude
TLI R·V	0	Fixes TLI at perigee
Mission orbit perigee radius	17 RE	Design value for min/max perigee behavior
PAM R·V	0	Fixes PAM at perigee
Mission orbit LRP angle	$\leq 36^\circ$	Maximum misalignment from resonant condition
Mission orbit energy	2:1 resonance	Energy from SMA consistent with 2:1 resonant condition
Mission orbit Kozai parameter	$0.60 \leq K \leq 0.80$	Controls long-term perigee behavior
Mission orbit ecliptic AOP	$\geq 30^\circ$	Controls maximum eclipse behavior
Position/velocity continuity	-	Position/velocity continuity between all segments

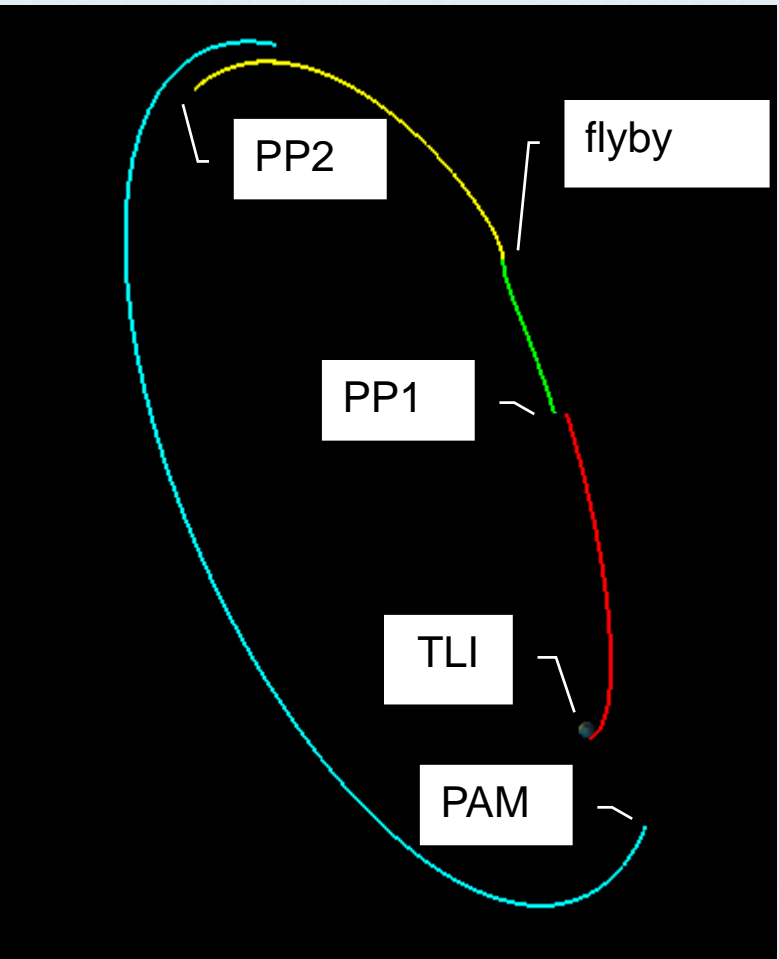

Guess with Discontinuities

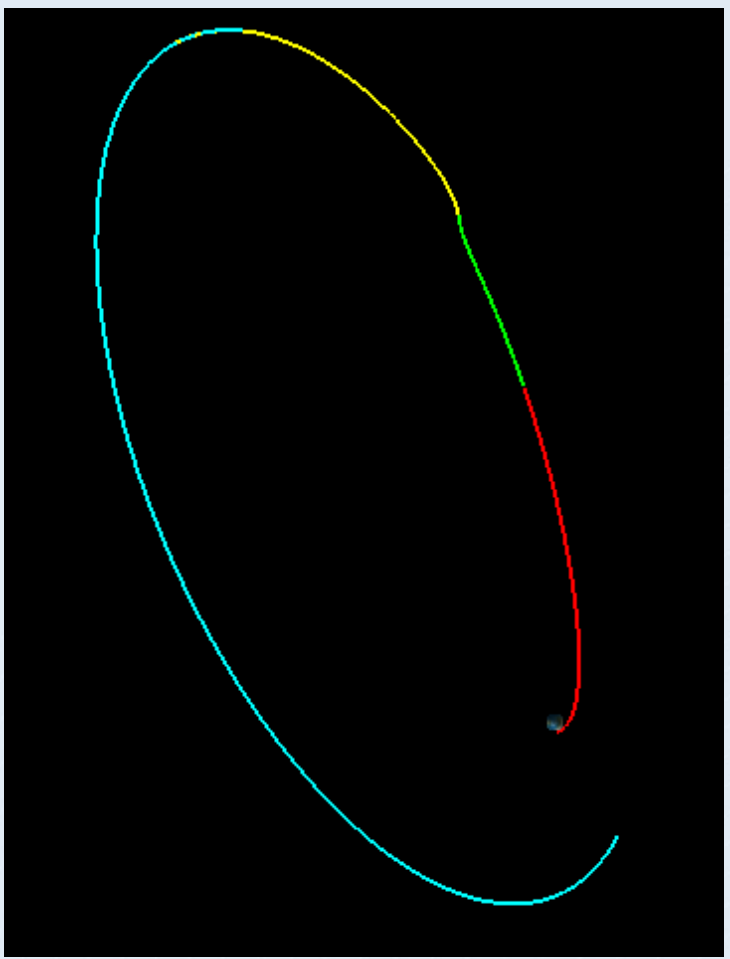
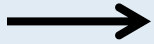

Solution, No Discontinuities

- ◆ Starts with converged outbound solution
- ◆ Back-propagates from PAM through flyby to TLI
- ◆ Uses targeting sequence to add on phasing loops
 - *Two-body initial guess for A1–A3, P1–P3 burns*

- ◆ Insertion constraint is now enforced at insertion, not at TLI
 - *Small out-of-plane components are added to PAM to correct inclination at TLI*
 - *This is a side effect of the two-stage approach; would go away in an end-to-end solution*

Parameter	Value	Description
P1–P3 altitude	≥ 600 km	Phasing loop perigee altitude
A3 radius	\leq pre-flyby radius	
A2 radius	$A1 \leq A2 \leq A3$	
A1 radius	275,000 km	A1 design radius
Separation altitude	200 km	LV requirement
Separation inclination	28.5° TOD	LV requirement
Separation epoch	match launch modeling & desired phasing loop duration	Analytical model based on launch site
Launch RA	Consistent w/ KSC launch	

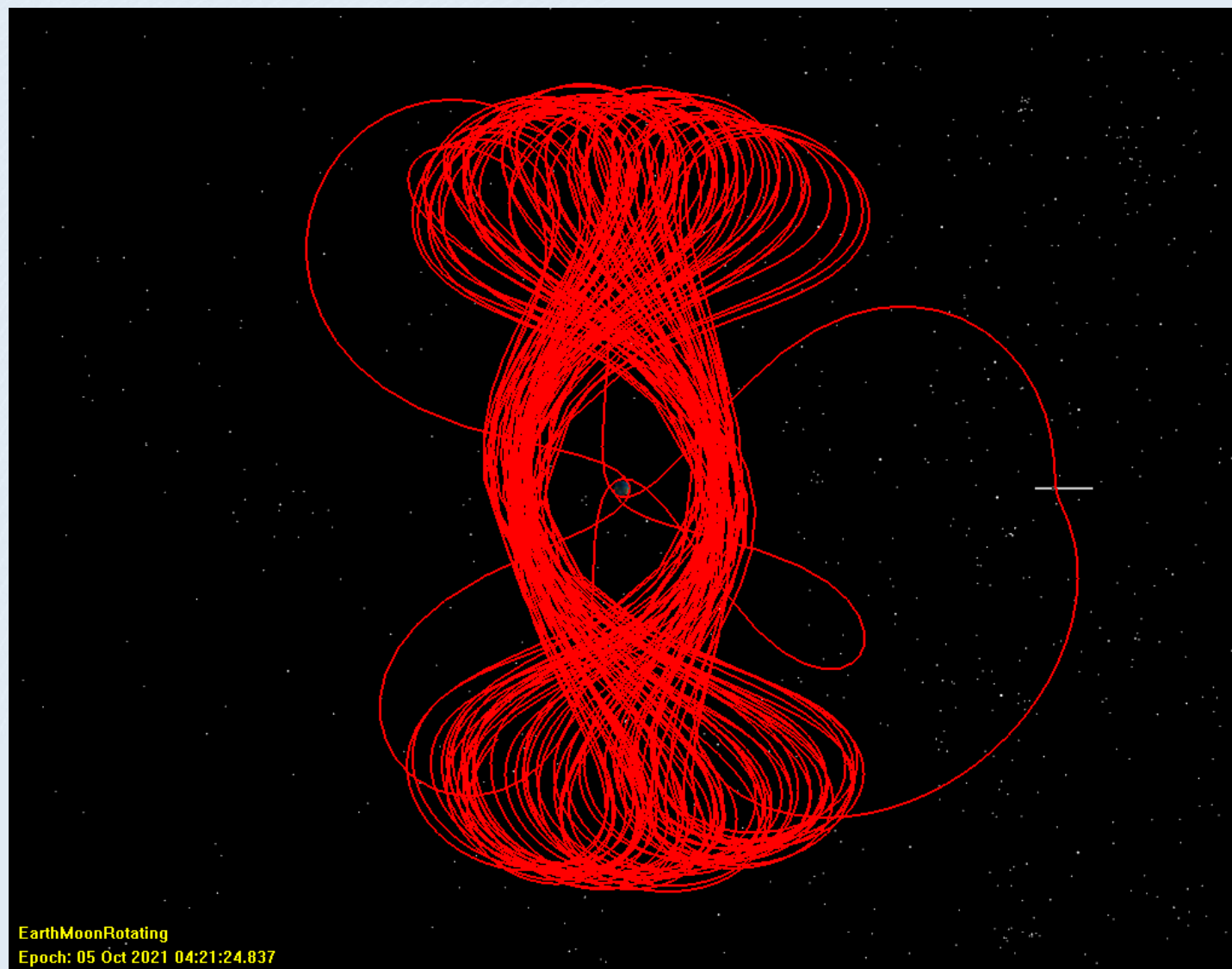



*DISCUSSION AND
QUESTIONS*



GMAT

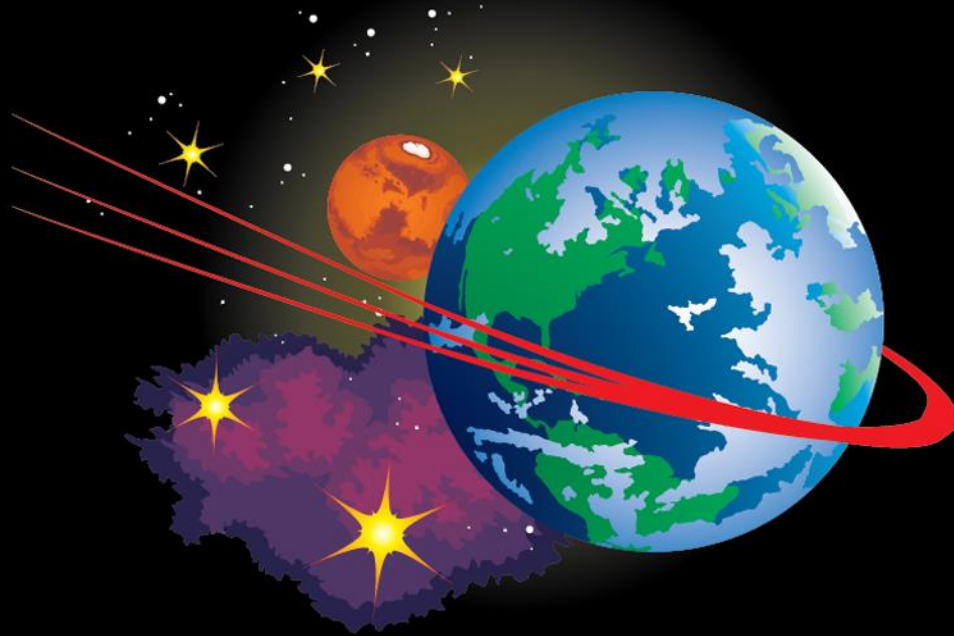
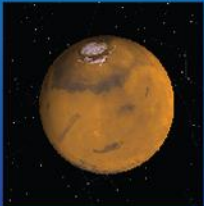
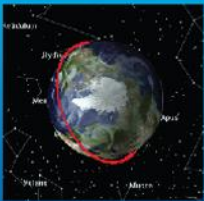
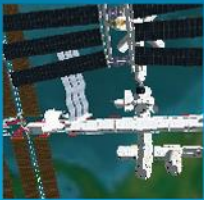
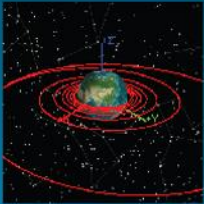
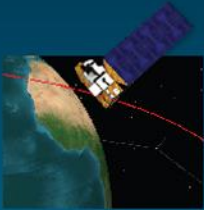

GMAT Navigation

Darrel J. Conway, Thinking Systems, Inc.

This presentation Uses Materials in the GMAT Simulation and Estimation Tutorials, Written by D. S. Cooley of NASA GSFC

NASA Goddard Space Flight Center

general mission analysis tool

Outline

- I. GMAT Navigation Overview**
- II. Estimation Walkthrough**
- III. Discussion and Questions**



GMAT NAVIGATION OVERVIEW

GMAT

Navigation Capabilities

- **Estimators**
 - Batch Least Squares
 - Under Development: Extended Kalman Filter
- **Measurement Simulator**
- **Measurement Models**
 - DSN 2-way Range and Doppler
 - (Alpha) GN 2-way Range and Doppler
 - (Alpha) SN 4-Leg Range and 5-Leg Doppler
- **Solve-For Parameters:**
 - Cartesian State
 - Cd and Cr
 - Measurement Bias
- **Built as a GMAT Plug-In**
 - Navigation Features Script Based
 - Alpha Measurements Disabled by Default

GMAT's BLS Estimator

- Coded from Tapley, Schutz and Born,
Statistical Orbit Determination
- Extended with Features from GTDS
 - Robust Inversion Code
 - Sigma Editing
 - Detailed Estimation Output
 - GTDS Based Convergence Criteria
- Provides Results Comparable to GTDS
- Approved for Operations for SOHO
 - Pending successful ORR, 2017-01-31

Measurement Models

- Measurements Contained in “TrackingFileSet”s
- Specified by the Path Followed by Signals
- R2016a Measurement Models:
 - DSN Range, in Range Units
 - DSN Doppler
- Alpha Measurements:
 - 2-way Range and Doppler
 - 4-Leg Range and 5-Leg Doppler (TDRSS)

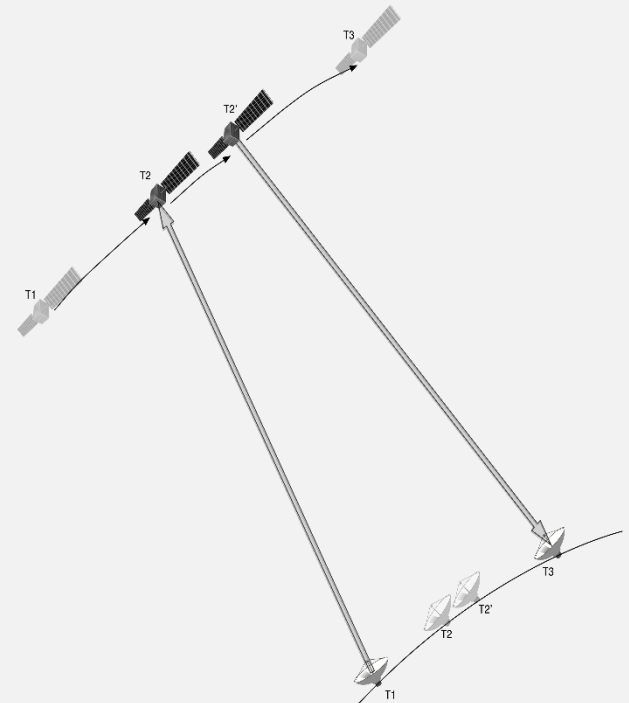

GMAT Nav Components

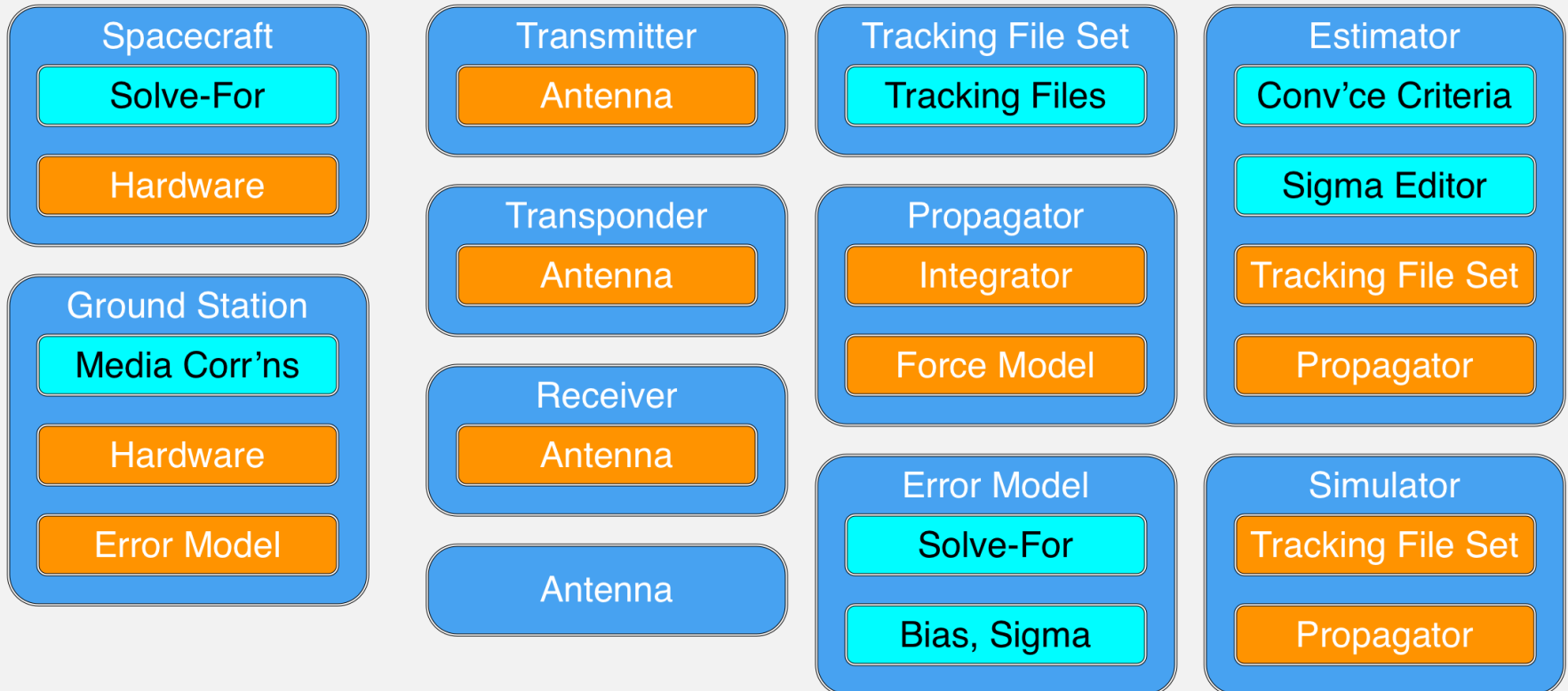



ESTIMATION
WALK
THROUGH



GMAT

Configuring Resources (1 of 4)

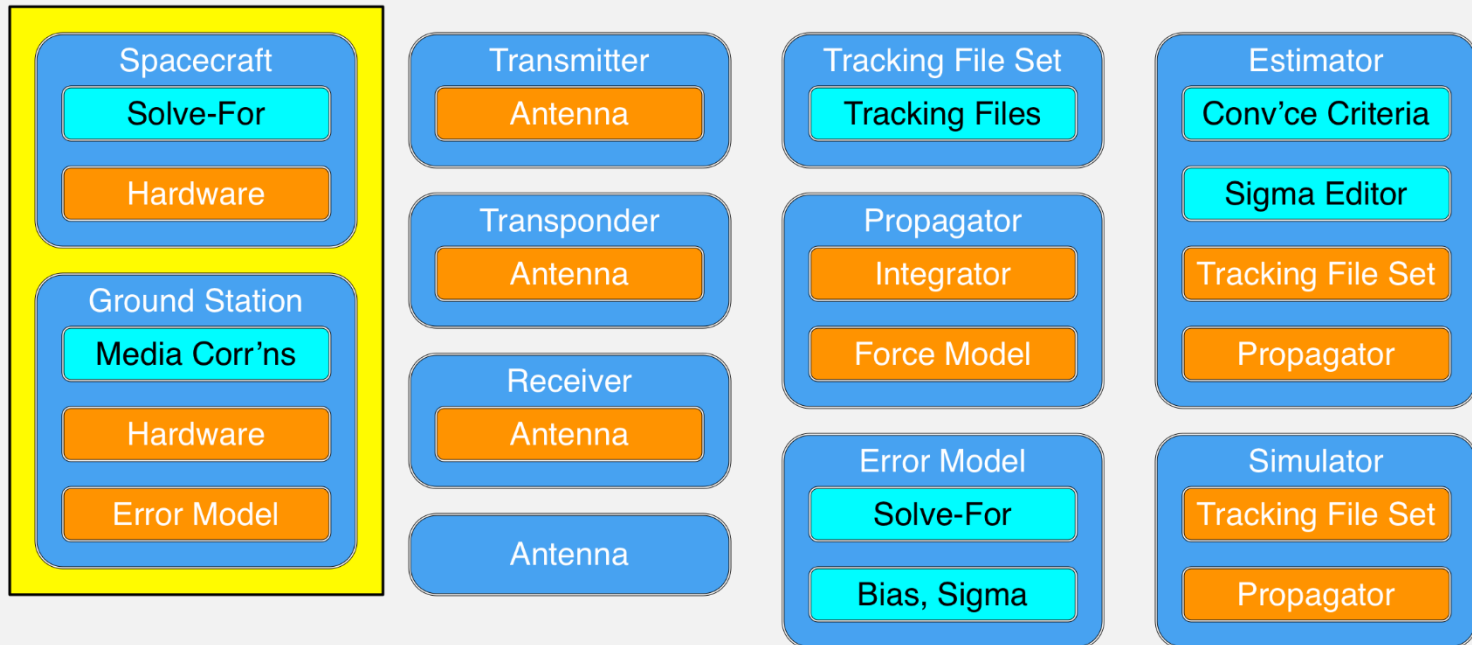

Configuring Resources (2 of 4)

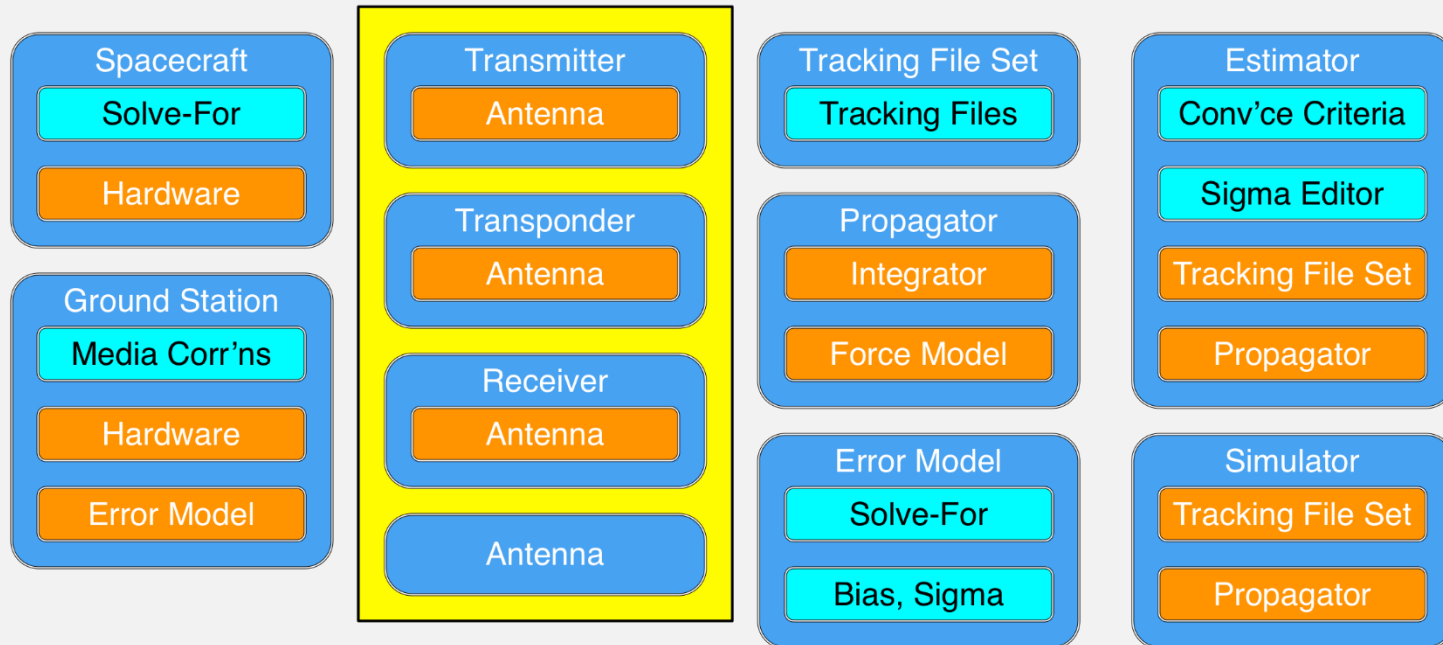

Configuring Resources (3 of 4)

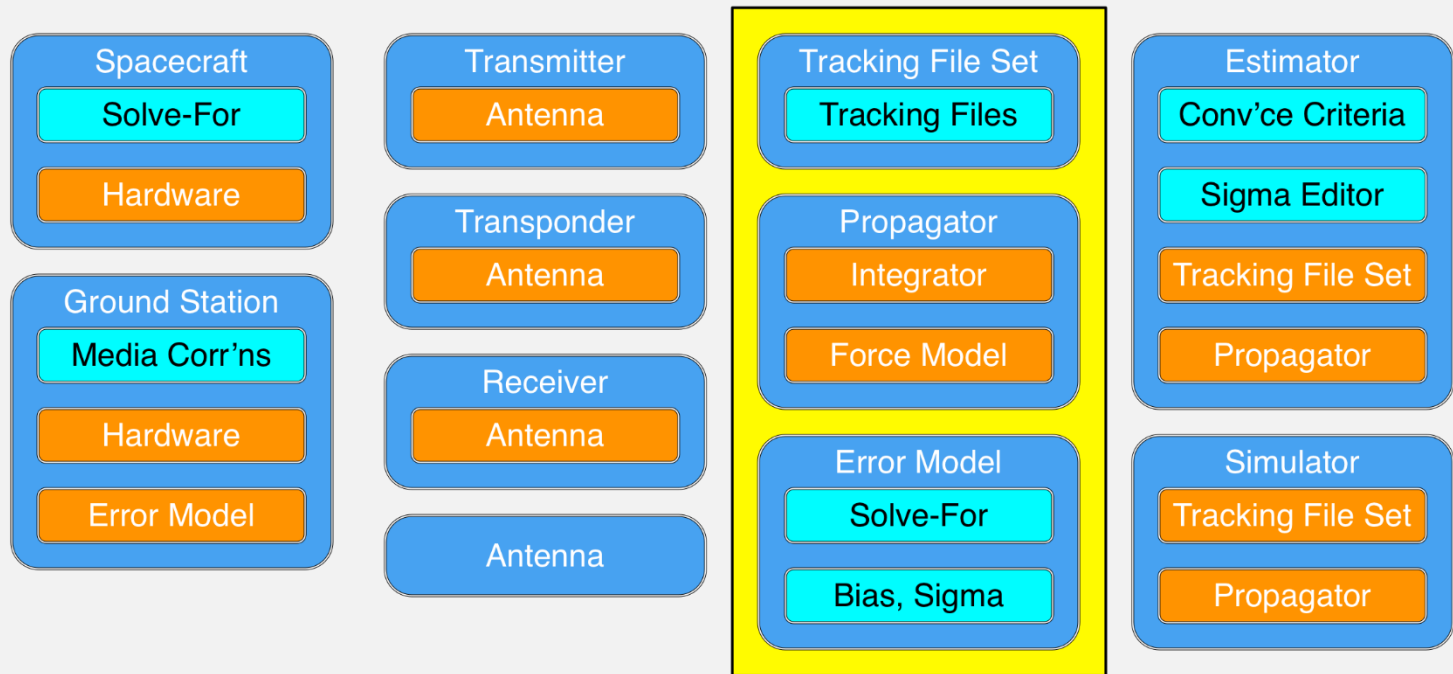

Configuring Resources (4 of 4)

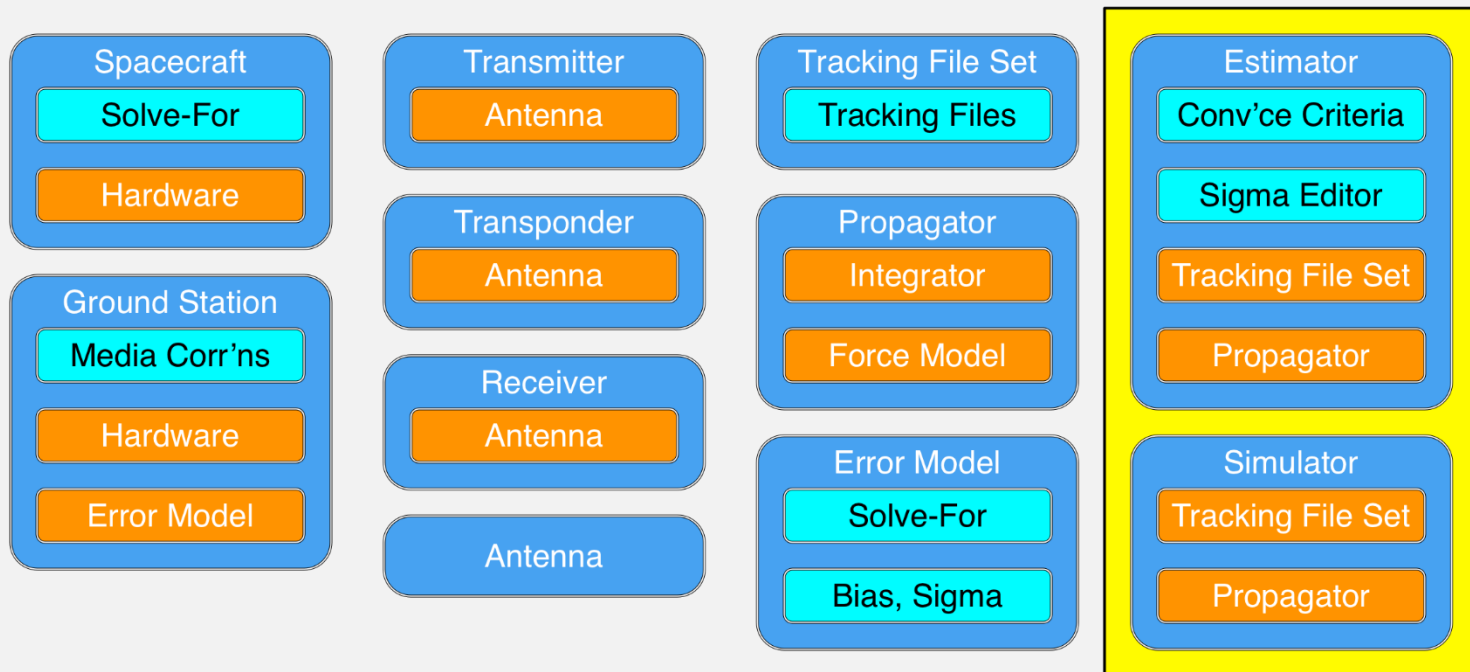

Mission Sequence

- One Command: RunEstimator

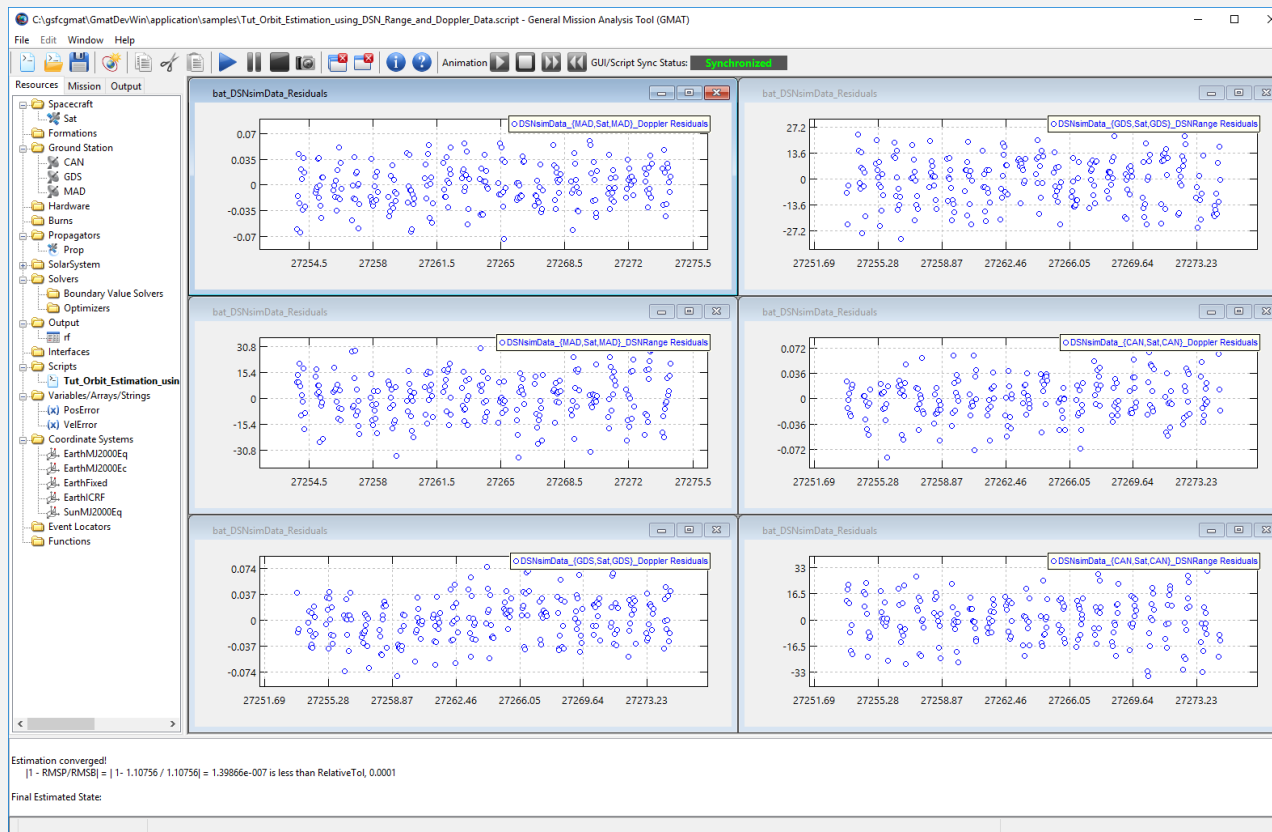

Output Details

- Output Data:
 - Estimation Status (Converged, or Failure Reason)
 - Final Estimated State
 - Final Covariances and Correlations
 - Detailed Estimation Report



**DISCUSSION
AND
QUESTIONS**

GMAT

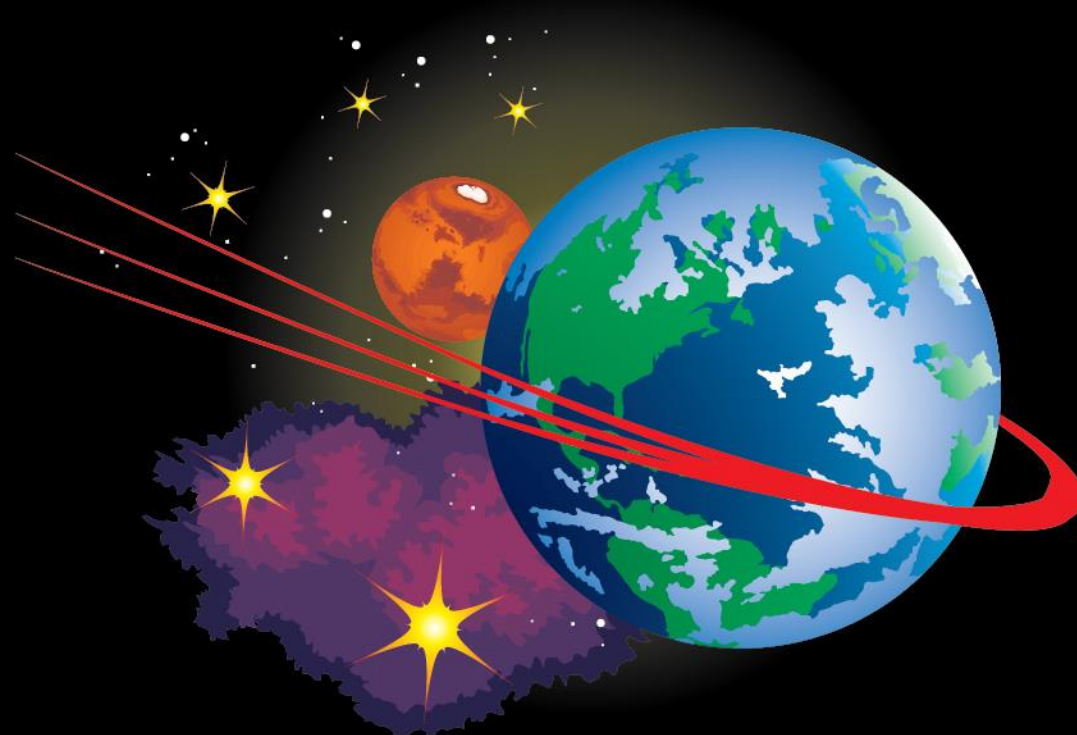

Collocation Stand Alone Library and Toolkit (CSALT)

general mission analysis tool

The Optimal Control Problem

$$J = \sum_{k=1}^N (\Phi[y_o^{(k)}(t_o), t_o, {}^{(k)}y^{(k)}(t_f), t_f^{(k)}]) + \int_{t_o}^{t_f} \lambda^{(k)} [x^{(k)}(t), u^{(k)}(t), t^{(k)}] dt$$

subject to the dynamics constraints, f ,

$$\dot{y}^{(k)}(t) = f^{(k)}[y^{(k)}(t), u^{(k)}(t), t^{(k)}]$$

the algebraic path constraints, g ,

$$g_{min}^{(k)} \leq g[y(t), u(t), t] \leq g_{max}^{(k)}$$

the integral constraints, w ,

$$w_{min}^{(k)} \leq w[y(t), u(t), t] \leq w_{max}^{(k)}$$

and the boundary conditions, φ

$$\varphi_{min}^{(k)} \leq \varphi[y_o^{(k)}(t_o), t_o, {}^{(k)}x^{(k)}(t_f), t_f^{(k)}] \leq \varphi_{max}^{(k)}$$

Trajectories and Phases

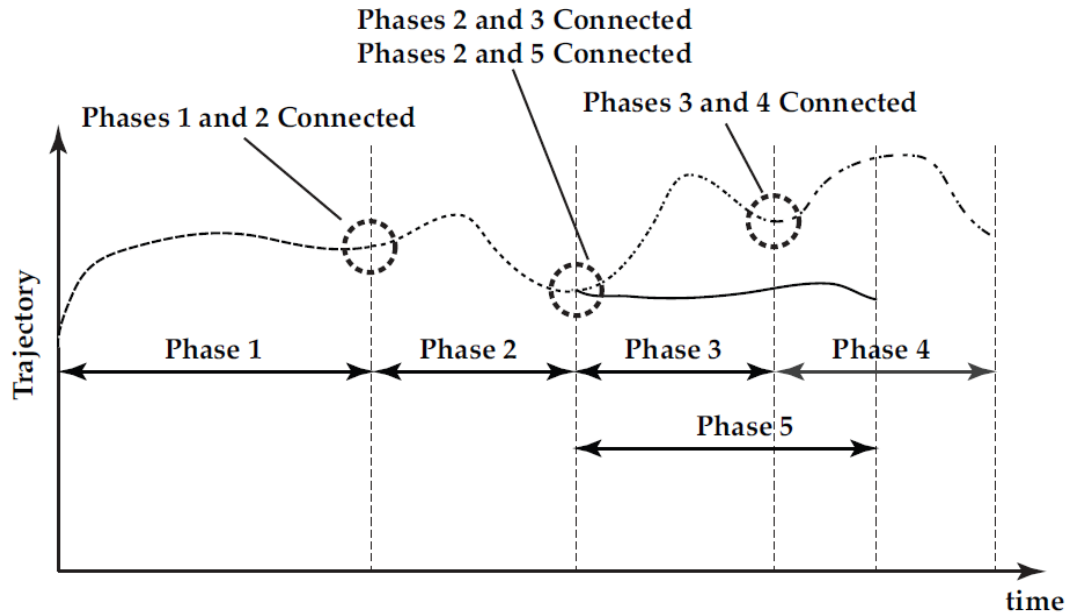

Fig. 1: Schematic of linkages for multiple-phase optimal control problem. The example shown in the picture consists of five phases where the ends of phases 1, 2, and 3 are linked to the starts of phases 2, 3, and 4, respectively, while the end of phase 2 is linked to the start of phase 5.

Note, the figure above was taken from Patterson, M, and Rao, A, A MATLAB Software for Solving Multiple-Phase Optimal Control Problems Using hp-Adaptive Gaussian Quadrature Collocation Methods and Sparse Nonlinear Programming".

User Stories: Trajectory Regimes

ID	Description
CO.TD-1	Basic Orbit Transfer: I need to design an optimal maneuver to transfer to a nearby orbit.
CO.TD-2	Body to body transfer: I need to design a trajectory that does a direct transfer from one body to another, in my case, from Earth to Moon.
CO.TD-3	Interplanetary Multiple flyby: I need to design a trajectory that leaves Earth, performs multiple gravitational flybys, and arrives at a final target celestial body. I have a guess at the flyby times, order, and flyby conditions at each body.
CO.TD-4	Spiral: I need to design a trajectory that spirals into and/or away from a celestial body requiring many (100s) of revolutions.
CO.TD-5	Libration point maintenance: I need to use collocation to improve the robustness and quality of libration stationkeeping solutions.

User Stories: Trajectory Regimes

ID	Description
CO.TD-6	Weak stability transfer: I need to use collocation to find trajectory transfers in a weak stability, multi-body environment.
CO.TD-7	Formation: I need to use collocation to optimize maneuvers of multiple spacecraft.
CO.TD-8	Rendezvous/Prox Ops: I need to use collocation to optimize rendezvous and docking operations and proximity operations.
CO.TD-9	Probe Separation: I need to use collocation to determine optimal trajectories for probe release and spacecraft separation planning.

GMAT and CSALT

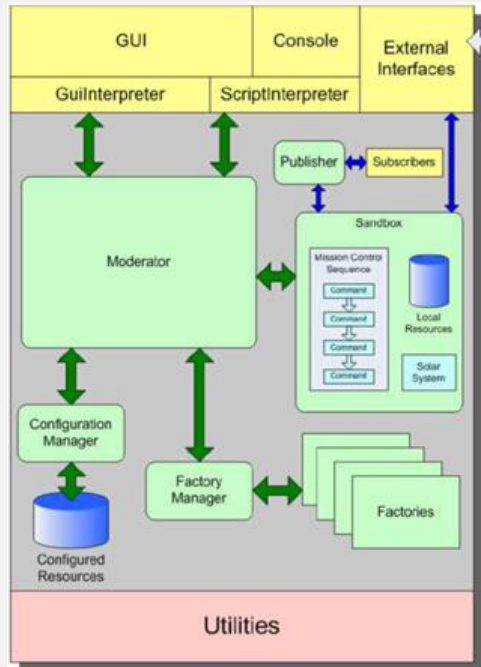

GMAT High Level Design

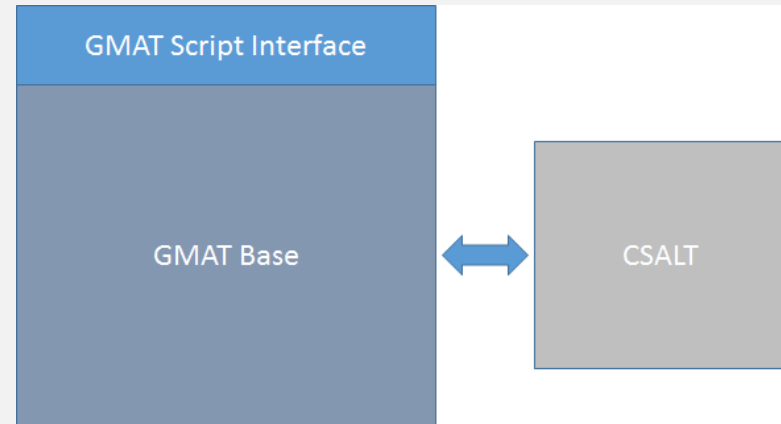

CSALT MATLAB Prototype Benchmarking Results

Problem Name	Truth Source	GMAT Prototype Optimal Cost Function	External Truth Optimal Cost Function	(gmat-truth)/truth
Rayleigh (control path constraint)	SOS	44.72093885	44.7209362	5.925E-08
Rayleigh (state and path constraint)	SOS	44.8044450	44.8044433	3.794E-08
Goddard Rocket Problem	SOS	18550.873	18550.872	5.390E-08
HyperSensitive	SOS	6.72412985	6.72412325	9.815E-07
Conway Low Thrust	SOS	9.51233830E-02	9.51233834E-2	-4.015E-09
Linear Tangent Steering	SOS	5.54570878E-01	5.54570879E-1	-1.803E-09
Brachistichrone	SOS	3.12480130E-1	3.12480130E-1	0.0*
Schwartz	PSOPT	2.3530487852E-14	4.634554e-15	0.0*
Bryson_Denham	PSOPT	3.9999973492	3.999539	0.0^
Interior Point Constraint	PSOPT	9.205314E-01	9.205314e-01	0.0*
Bryson Maximum Range	PSOPT	-1.712315	-1.712316	-5.840E-7
Obstacle Avoidance	PSOPT	4.571044	4.571044	0.0*
MoonLander	PSOPT	1.4203135394	1.420377e+00	-4.468e-05
GMAT Software Rau Automatica	Analytic	8.96379680285E-03	8.96379680285788E3	

AAS Guidance and
Control Conference, Feb.

7 2017

CSALT Applications

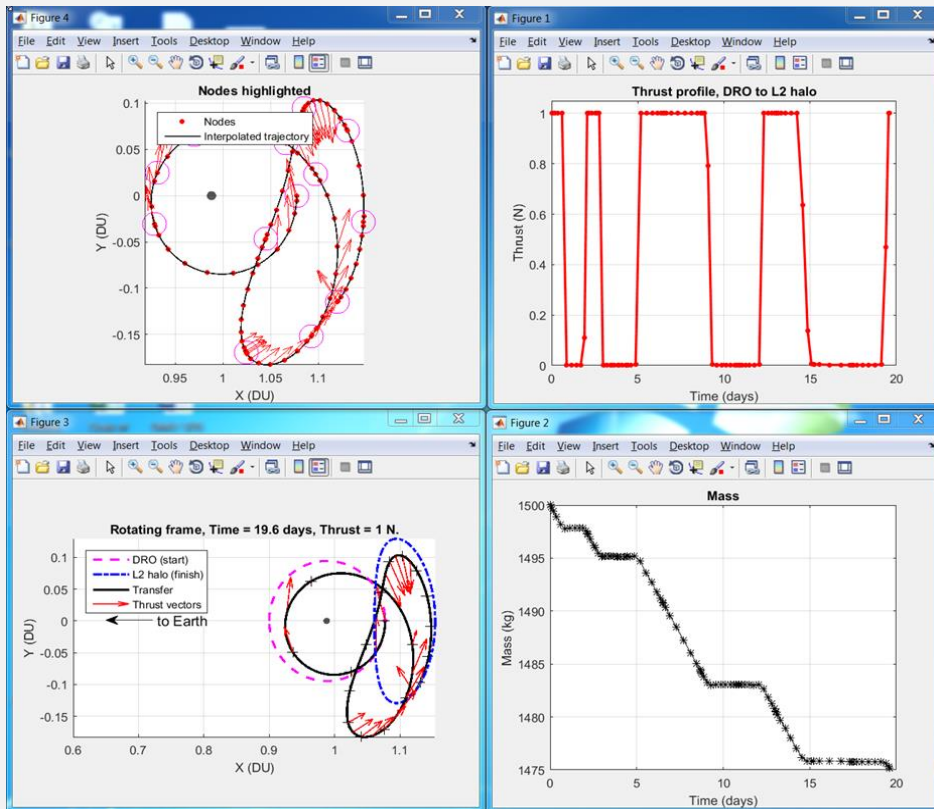

DRO to L2 Transfer

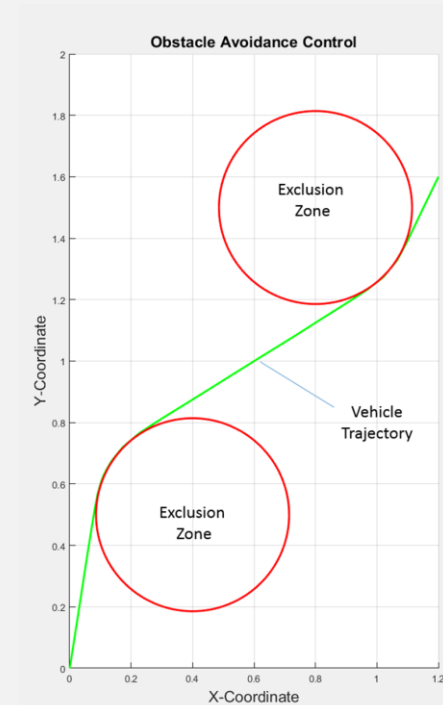

Obstacle Avoidance Problem

CSALT Applications

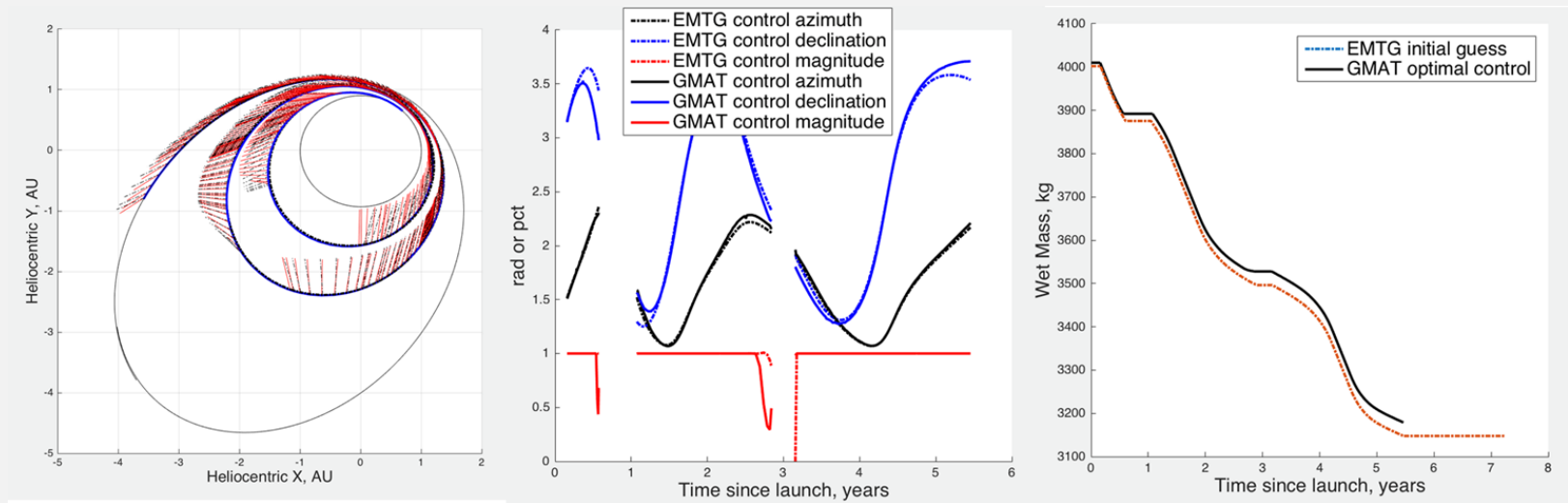

Interplanetary Application with Comparison to EMTG

A graphic illustration of the Earth, Mars, and a nebula with stars. The Earth is the largest sphere, showing continents and oceans. Mars is a smaller, reddish sphere to its left. Below them is a colorful nebula with purple and blue hues and several bright yellow stars. The background is black with a few small white stars.

**DISCUSSION
AND
QUESTIONS**

A red comet tail graphic consisting of several parallel lines that curve from the bottom left towards the right, ending near the 'G' in the 'GMAT' text.

GMAT

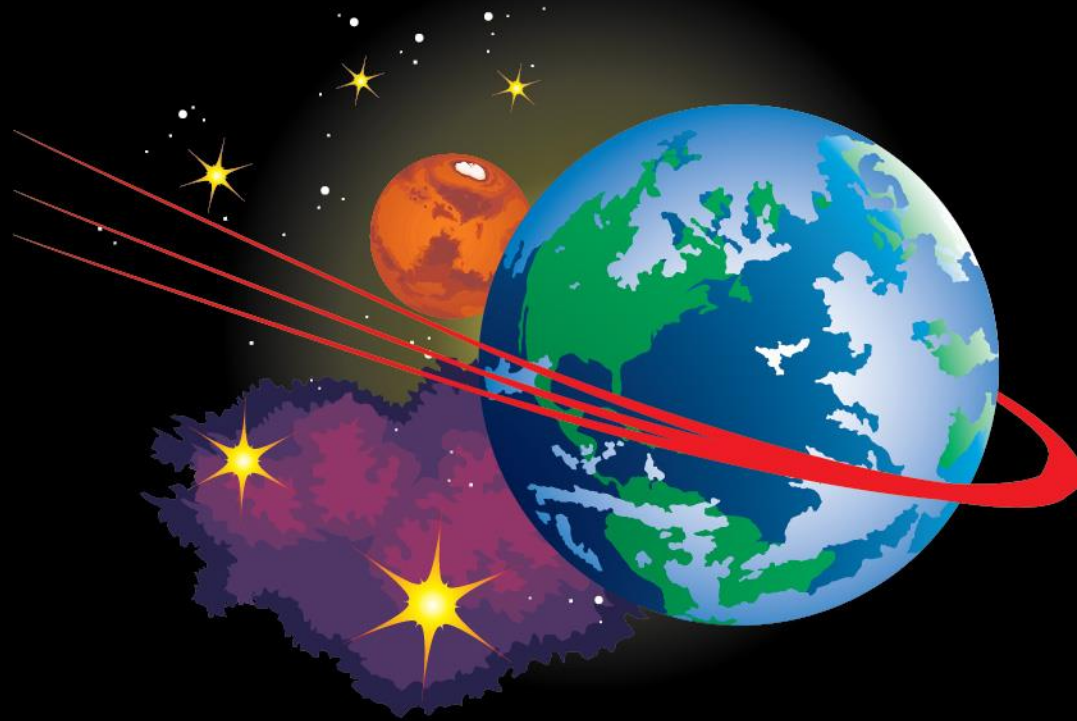

Wrap Up

general mission analysis tool

FDF OD Operations

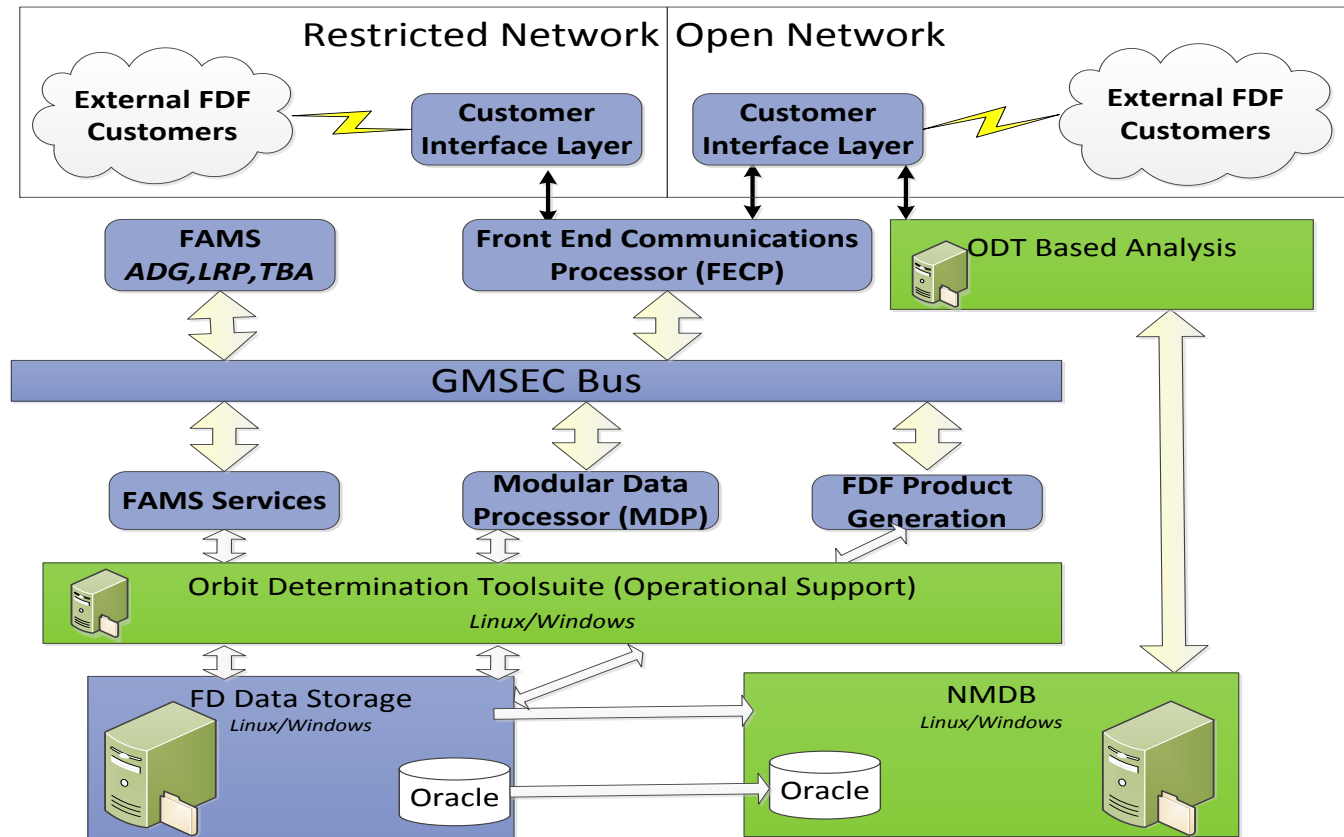

A significant part of certification of navigation functionality is using GMAT in the FDF operational environment.



SDO Operations

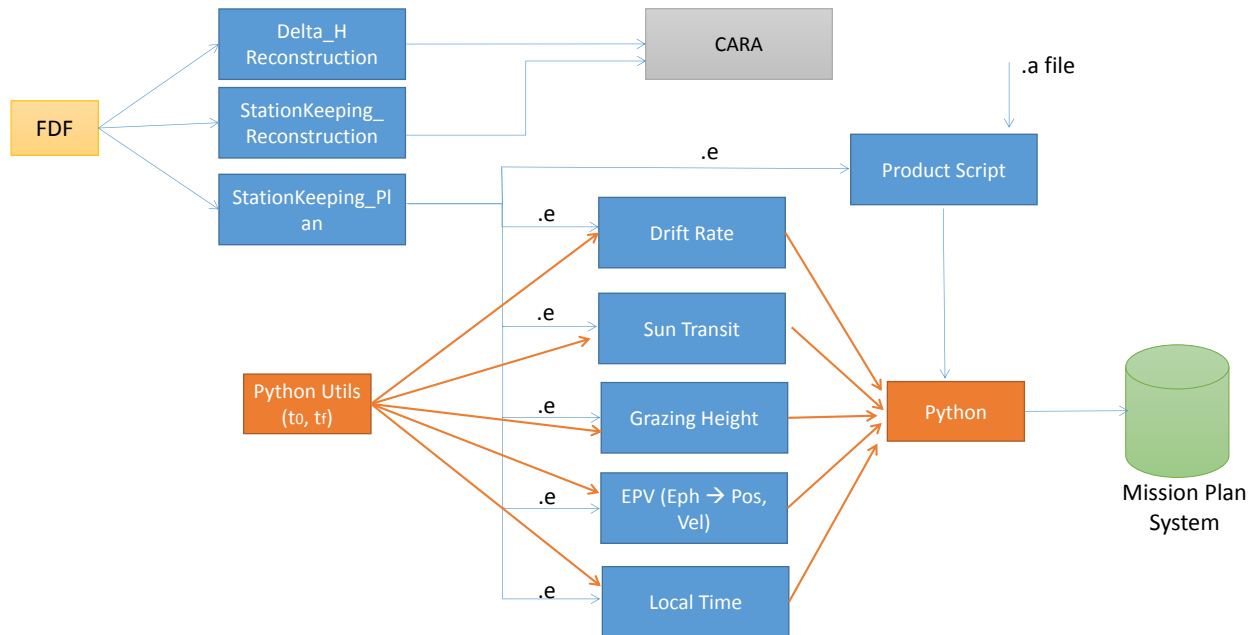

We are performing final testing for using GMAT as the core tool in the SDO MOC for maneuver planning and product generation.



GMAT API and Potential Future Efforts

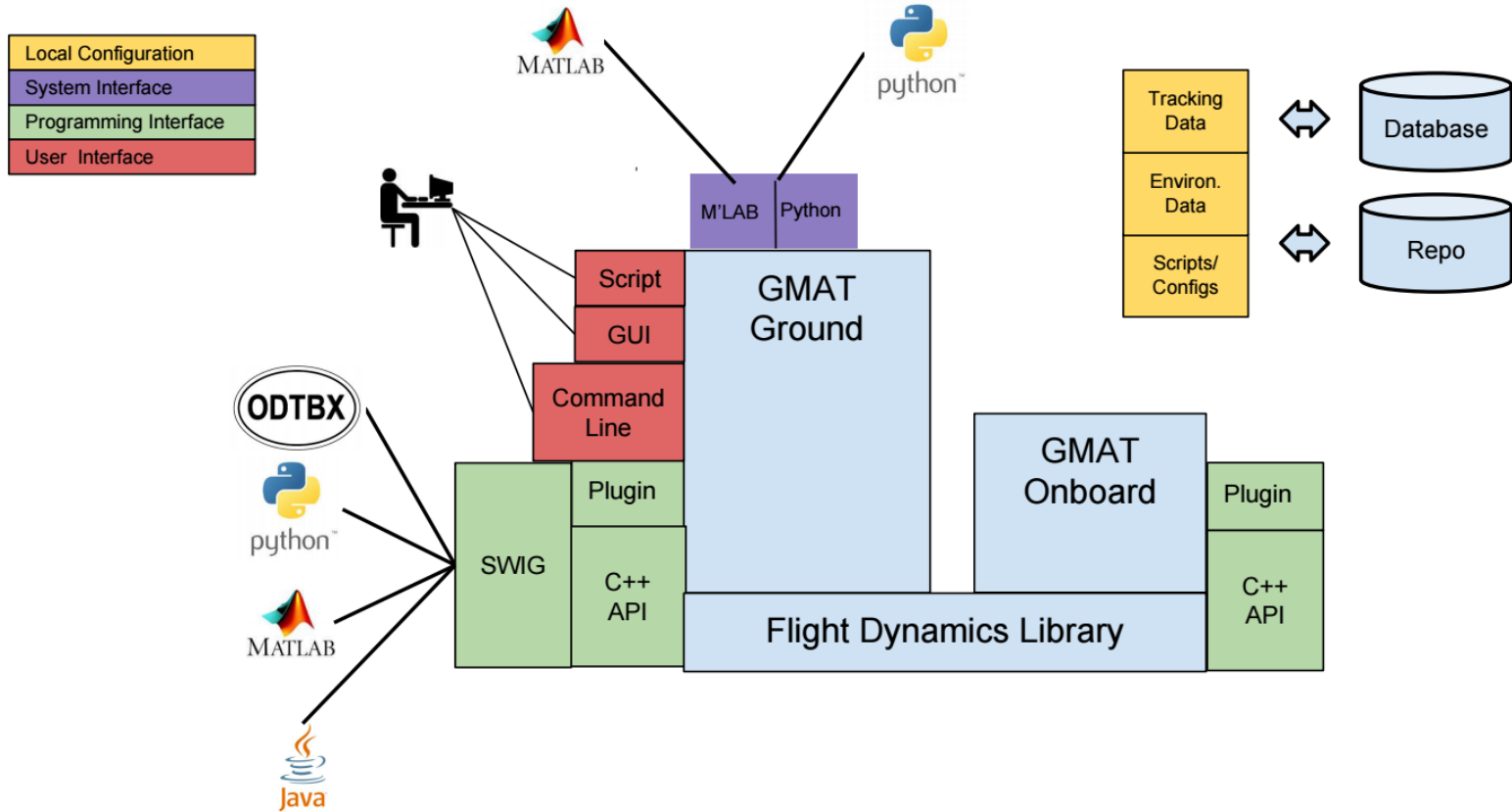

We are currently in the early phases of developing a GMAT API, and considering the possibility of deconstructing GMAT to allow components to be used onboard for real time mission planning and opportunistic science.



Finding Out More



- **Main information portal: gmatcentral.org**
- [For New Users](#)
 - [Obtain GMAT](#)
 - [Training Videos](#)
 - [Training Material](#)
 - Sample Missions (scripts distributed with application)
 - [User Guide](#) (also pdf distributed with application)
- For New Developers
 - [Obtain Code](#)
 - [Style Guide](#)
 - [Compilation Instructions](#)
 - [Design Docs](#) (also pdf distributed with application)





Thanks! Questions?

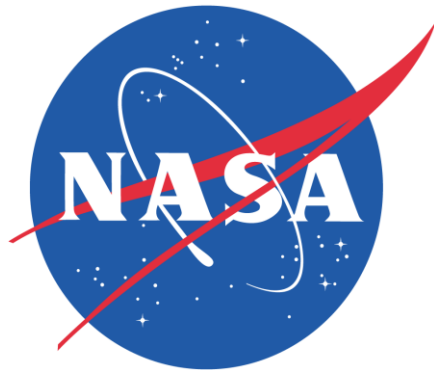



**DISCUSSION
AND
QUESTIONS**

GMAT



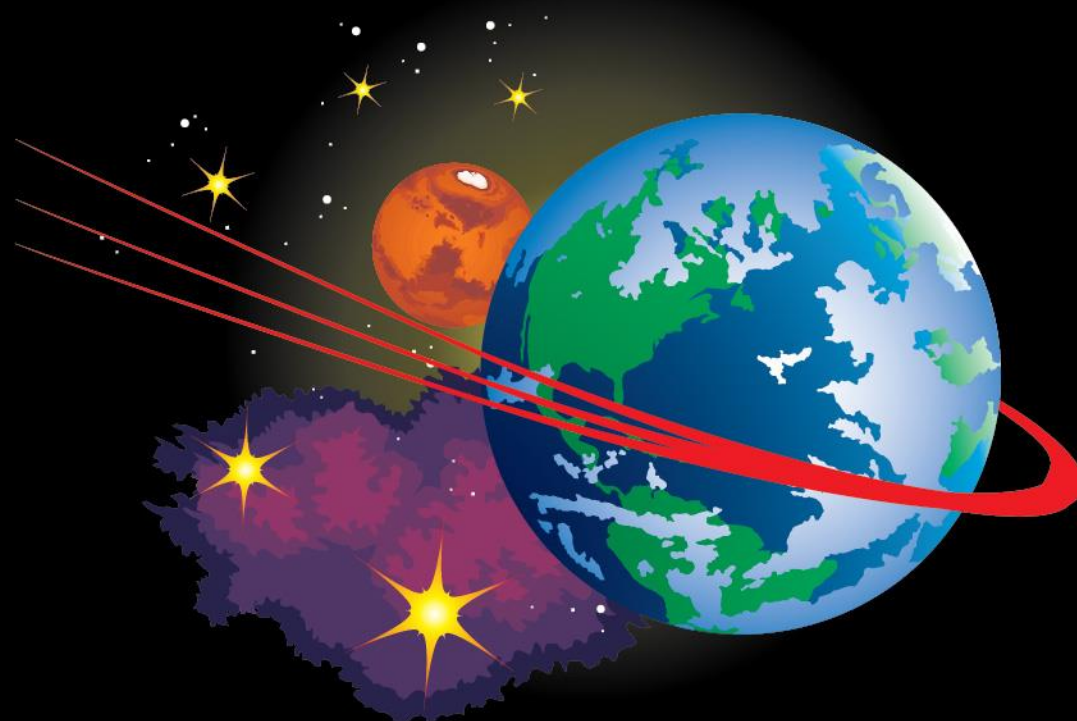
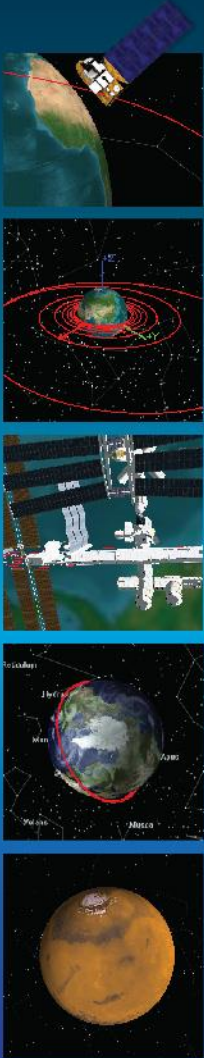

Extras

general mission analysis tool

Software Tool Comparison



		Evaluation Area	GMAT	FreeFlyer	STK	EMTG	MALTO	Mystic	Copernicus	OTIS
Orbital Applications	LEO Orbit Dynamics	Y	Y	Y	N	N	Y	Y	Y	
	Lunar	Y	Y	Y	N	N	Y	Y	Y	
	Low Energy	Y	Y	Y	N	N	Y	Y	Y	
	Planetary	Y	Y	Y	Y	N	Y	Y	Y	
	Interplanetary	Y	Y	Y	Y	Y	Y	Y	Y	
	Distributed Missions	Y	Y	Y	N	N	N	Y	N	
Modelling and Functionality	Chemical Propulsion	Y	Y	Y	Y	Y	Y	Y	Y	
	Electric Propulsion	Y	Y	Y	Y	Y	Y	Y	Y	
	Collocation	Y*	N	N	N	N	N	N	Y	
	Parameter Optimization	Y	N	Y	Y	Y	N	Y	N	
	Differential Dynamic Programming	N	N	N	N	N	Y	N	N	
	Primer Vector	N	N	N	N	N	N	Y	N	
	Domain specific program. language	Y	Y	N	N	N	N	N	N	
	Built in astro library computations	Y	Y	Y	N	N	N	N	N	
Lifecycle Application	Planning	Y	Y	Y	Y	Y	Y	Y	Y	
	Operations	Y	Y	Y	N	N	Y	Y	N	
	Navigation	Y	Y	Y	N	N	N	N	N	
Availability	Open Source	Y	N	N	Y	N	N	N	N	
	Open Application	Y	N	N	Y	N	N	N	N	
	Open Documentation	Y	N	N	Y	N	N	N	N	

* In progress/under development



Past Release Summary



- GMAT R2013a
 - First production (non-beta) release
 - Focused entirely on QA and documentation
 - Very few new features—but many improved
 - New support for ICRF coordinate systems
- GMAT R2013b (internal)
 - First operationally-certified release
 - Focused on ACE mission requirements
- GMAT R2014a
 - Public release of all R2013b features
 - State representations
 - Attitude models
 - Customizable orbit segment colors
 - Mars-GRAM 2005 atmosphere model
 - LHS parameter dependencies
 - New solver algorithms
- GMAT R2015a
 - GMAT Functions
 - Python Interface
 - Eclipse Location
 - Ground station contact location
 - SNOPT Optimizer
 - Space weather modelling
 - 3D models for celestial bodies
 - Solver status window



Ongoing Navigation Development



- 2009 - 2011
 - Began evaluation of GMAT as a possible navigation tool in 2009
 - Worked with AFRL and IRAD funding to design and implement a navigation subsystem and demonstrate feasibility.
 - Key Conclusion: GMAT could perform OD without significant design changes.
- 2012 – 2013
 - Interplanetary models dynamics models
 - DSN data types
- 2014 – 2015
 - Measurement model re-design based on GEODYN principles
 - User interface re-design for usability based on FDF feedback
 - Testing against flight data
 - Improved batch estimator
 - New data types
 - Measurement editing
 - Improved Reporting
 - Improved bias modelling
 - Improved inverse algorithms for normal equations
 - New Solve-fors
 - Low thrust navigation studies
- Major testing effort in FDF

GMAT was selected as the core tool for GSFC navigation and is preparing for operational use in fall of 2016

AAS Guidance and Control Conference, Feb. 7, 2017



Extensibility



- GMAT's modern architecture was designed for extensibility
- Extensible System Interfaces
 - MATLAB
 - Python
 - API under development
 - Plugins
- Multiple User Interfaces
 - Script
 - GUI
 - Command line
 - API under development
- Extensible model subsystems
 - Dynamics Models
 - Environment Models
 - Estimators
 - Measurements
 - Propagators

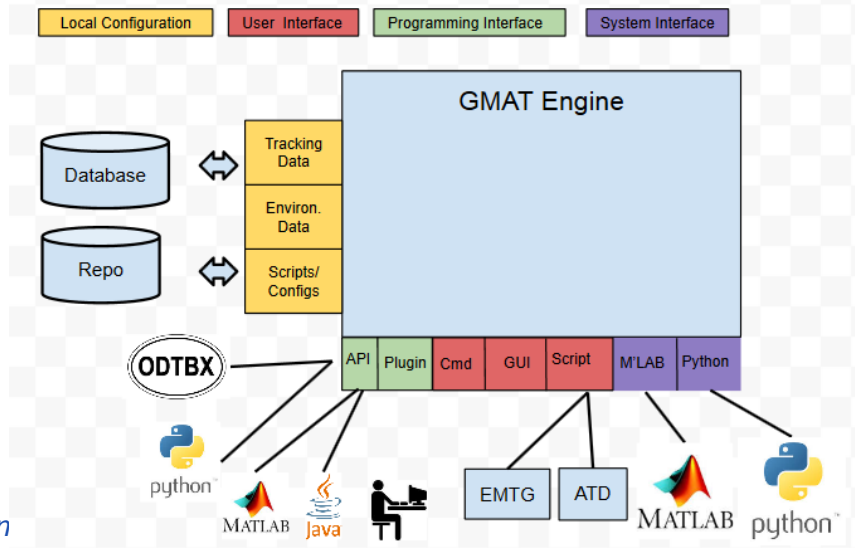
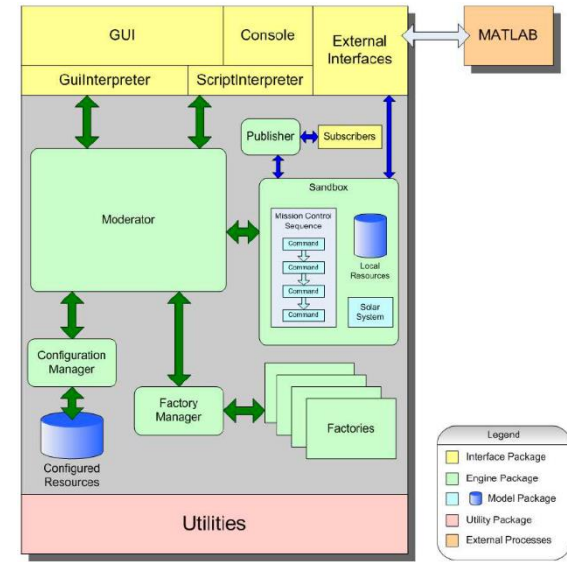

L3 Mission Design Requirements



ID	Parent ID	Title	Requirement	Compliance
L3_FD_1	MRD_10 , MRD_51	Mission Orbit SMA	The target mission orbit Semi-Major Axis (SMA) shall be 38 Re.	Comply. Design constraint.

TESS HEO Orbit Definitions

Lunar Resonance Phasing (LRP) or PLEP Angle

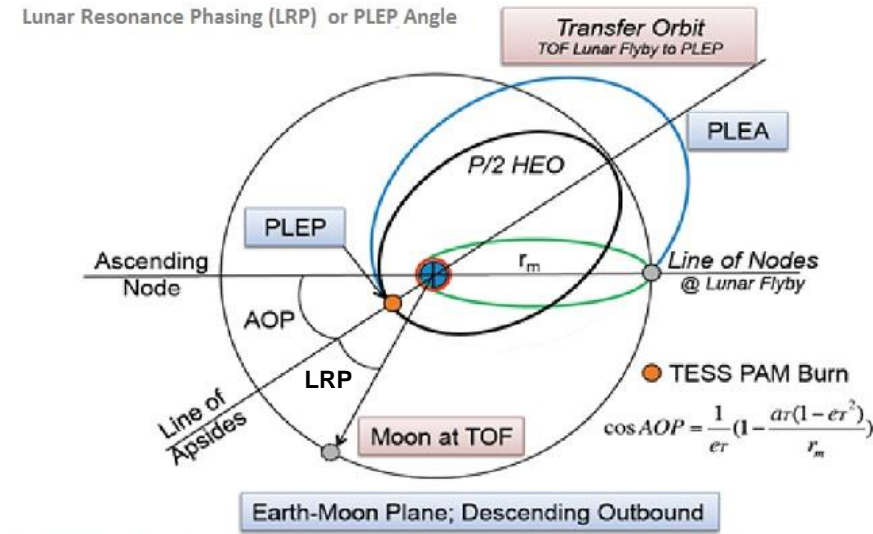

Change since PDR Peer Review

AAS Guidance and Control Conference, Feb. 7, 2017

Consistent with EXP-TESS-GSFC-RQMT-0015 Rev (-)

L3 Mission Design Requirements



ID	Parent ID	Title	Requirement	Compliance
L3_FD_3	MRD_53	Mission Orbit Minimum Perigee	FD shall target a mission orbit with a minimum perigee that shall stay above GEO radius + 200 km.	Comply. Results shown to 100 years.
L3_FD_29	MRD_52	Mission Orbit Maximum Perigee	FD shall target a mission orbit with a maximum perigee that shall stay below 22 Re for the duration of the mission.	Comply. All <20.5 Re
L3_FD_30	MRD_101	Transfer Orbit Maximum Apogee	FD shall target a lunar flyby that results in a transfer orbit with a maximum apogee less	Comply. All <80 Re

L3_FD_{29, 30, 33} replace old L3_FD_3 in terms of Kozai constant.

TESS HEO Orbit Definitions

Lunar Resonance Phasing (LRP) or PLEP Angle

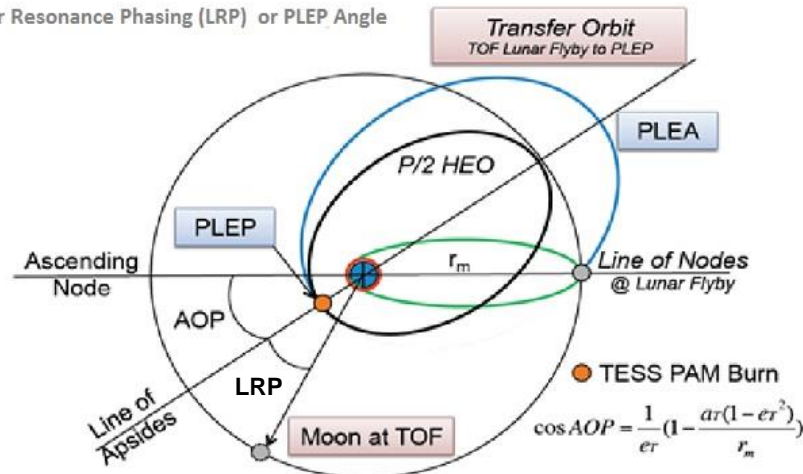

Change since PDR Peer Review



L3 Mission Design Requirements



ID	Parent ID	Title	Requirement	Compliance
L3_FD_21	MRD_54	Launch Period	FD shall design for at least 5 launch days in any given Lunar cycle.	Comply. At least 9 sol'ns/mo for current period.
L3_FD_22	MRD_55	Launch Window	FD shall design for launch windows of at least 5 minutes during each day of the launch period.	Comply. Current strategy meets req.
L3_FD_27	MRD_42	Commissioning Duration	FD shall design the phasing loops and post lunar encounter transfer orbit to achieve mission orbit within 2 months after launch.	Comply. PAM at < 43 days.
L3_FD_24	MRD_85	Sun in Instrument Boresight	FD shall design the PAM to occur when the sun is not within a FOV of 54°×126° centered on the camera boresight axis (X-Z plane) for ≥15 minutes.	Comply. Basis for sol'n selection.
L3_FD_28	MRD_104	Delta-V Budget	FD shall design ascent-to-mission orbit to require no more than 215 m/s delta-V with 99% probability of success.	Comply. See detailed analysis.
L3_FD_25	MRD_129	Maneuver Magnitude	The largest maneuver magnitude shall be <95m/s.	Comply. PAM < 75 m/s
L3_FD_4	MRD_56	Eclipse Frequency and Duration	FD shall target a mission sequence that limits the total number of eclipses from LV separation through the end of the prime mission to 2 eclipses with a maximum eclipse duration of 5 hours, and 14 additional eclipses with a maximum eclipse duration of 4 hours.	Comply. No more than 11 < 4hr + 1 < 6hr Needs updating

Requirements added to flow from L2



Lunar Flyby Orbit Geometry Options



- Data shows generally best results for:
 - Pre-flyby inbound
 - Post-flyby descending
 - Post-flyby outbound
- Pre-flyby ascending/descending can be selected
- For operational simplicity, we currently use ascending case only.
- Implies short-coast solution at Earth departure

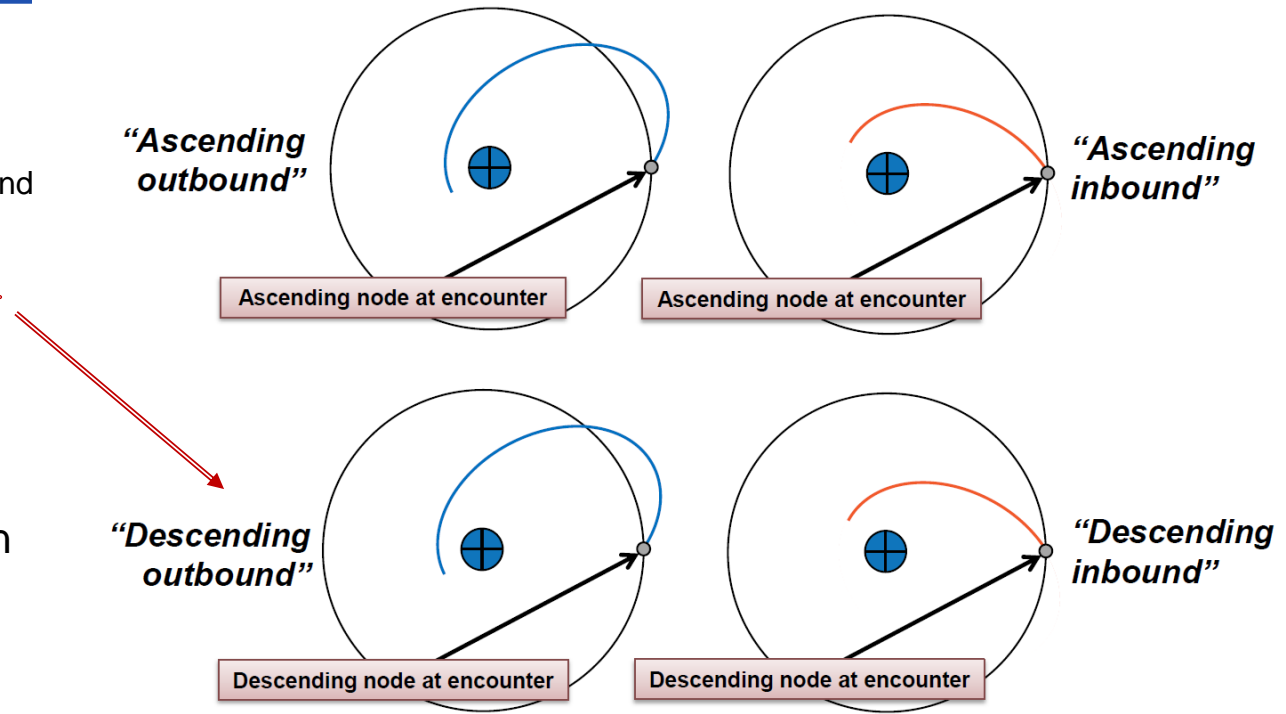

Figure 6: The four possible paths of the spacecraft following the lunar flyby.



From Gangestad, J. et al. "A High Lunar Resonant Orbit for Lower Cost Space Science Missions, AAS 13-810

Acronyms



- CSALT Collocation Stand Alone Library and Toolkit
- EMTG Evolutionary Mission Trajectory Generator
- GMAT General Mission Analysis Tool
- OGA Other Governmental Organization
- PAM Post Apogee Maneuver
- PLEP Post Lunar Encounter Periapsis
- SNOPT Sparse Nonlinear Optimizer
- TESS Transiting Exoplanet Survey Satellite

