

Construction with Regolith

CLASS / SSERVI / FSI

The Technology and Future of In-Situ Resource Utilization (ISRU)

A Capstone Graduate Seminar

Orlando, FL

March 6, 2017

Robert P. Mueller

Senior Technologist / Engineer

NASA

Kennedy Space Center – Swamp Works

Biography



- B.Sc. Mechanical Engineering, University of Miami
- M.S. Space Systems, Tech University of Delft, Netherlands
- M.B.A. Florida Institute of Technology
- ASCE Aerospace Division, Former National Chairman
- NASA Space Shuttle Engineer, ISS Engineer, Space Mission Architecture, Advanced Technology Development for Moon, Mars, Asteroids In-Situ Resource Utilization (ISRU) , Robotics for Construction
- 28 Years Experience at NASA KSC, JSC and JPL



Innovation Labs

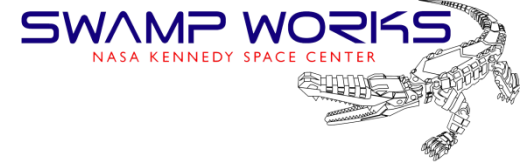

OH MAN. SWAMP WORKS.

AN ENTIRE BUILDING DEDICATED TO IN SITU RESOURCE UTILIZATION AND INVESTIGATION ON OTHER PLANETS AND ASTEROIDS! SCIENTISTS AND ENGINEERS FIGURING OUT HOW TO TEST THE LUNAR SURFACE FOR WATER AND MINE THE REGOLITH OF MARS FOR FUEL!



SWAMP
WORKS

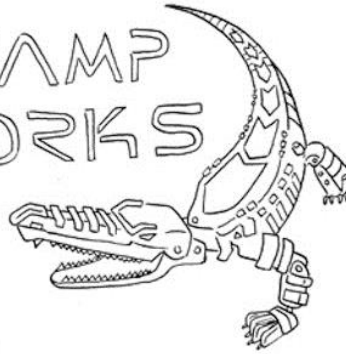

"WE'RE TRYING TO CLOSE THE LOOP ON LIFE SUPPORT," THEY SAID.

"TELL ME MORE!" I SAID.

AND THEY DID.

SWAMP WORKS
NASA KENNEDY SPACE CENTER

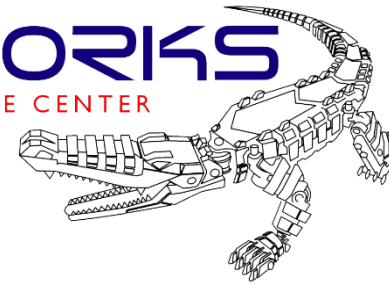

<http://www.tor.com/stories/2013/07/nasa-comic-alison-wilgus>



NASA Strategic Plan Objective 1.1



Expand human presence into the solar system and to the surface of Mars to advance exploration, science, innovation, benefits to humanity, and international collaboration.

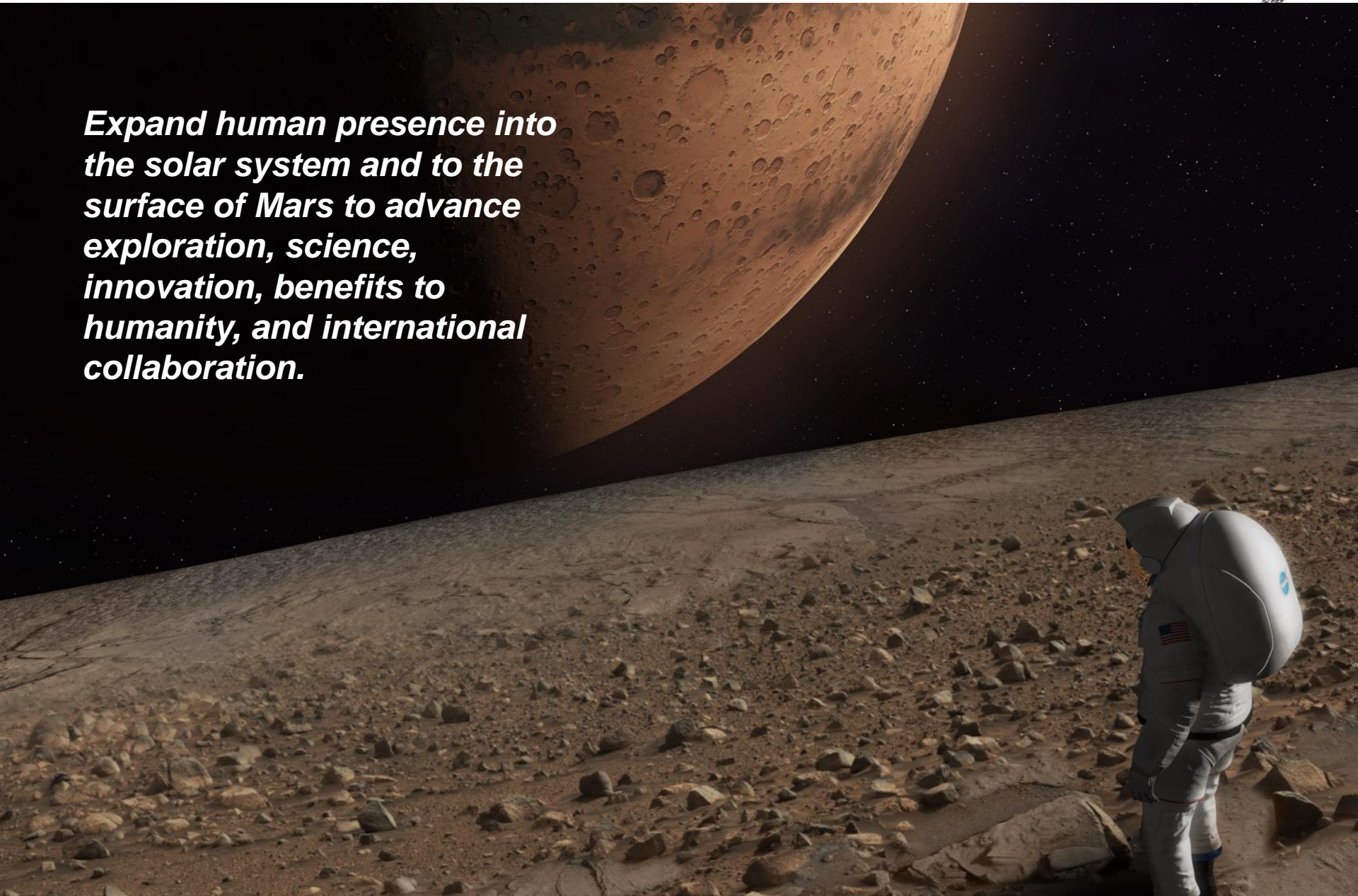

Objectives

- Broad exposure to Planetary Surface Construction using regolith as a building material
- Regolith and indigenous materials
- Space Environments
- Infrastructure required for Surface Settlement
- Understand the robotic construction tasks required in various space environments
- Case Study 1: Robotic excavation of regolith
- Case Study 2: Paver Based VTVL Pad
- Case Study 2: 3D printing a habitat for humans

Pioneering in Space

Pioneering involves any hardware or operation that harnesses and utilizes 'in-situ' resources to create products and services for robotic and human exploration

Five Major Areas of Pioneering

➤ ISRU: Resource Characterization and Mapping

Physical, mineral/chemical, and volatile/water



➤ ISRU: Mission Consumable Production

Propellants, life support gases, fuel cell reactants, etc.

➤ Civil Engineering & Surface Construction

Radiation shields, landing pads, roads, habitats, etc.

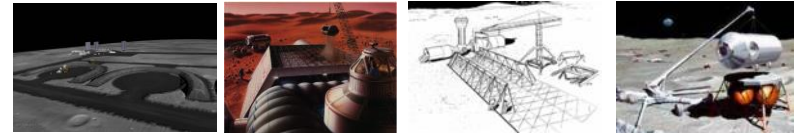
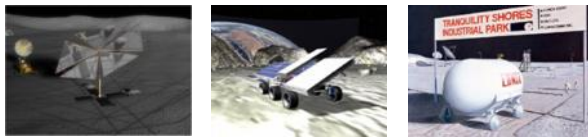

▪ In-Situ Energy Generation, Storage & Transfer

Solar, electrical, thermal, chemical



▪ In-Situ Manufacturing & Repair

Spare parts, wires, trusses, integrated structures, etc.

- **ISRU is a capability involving multiple technical discipline elements** (mobility, regolith manipulation, regolith processing, reagent processing, product storage & delivery, power, manufacturing, etc.)
- **Pioneering does not exist on its own.** By definition it must connect and tie to multiple uses and systems to produce the desired capabilities and products.

Lunar and Mars Resources

Regolith: Moon Resources

Ilmenite - 15%
 $\text{FeO} \cdot \text{TiO}_2$ (98.5%)
 Pyroxene - 50%
 $\text{CaO} \cdot \text{SiO}_2$ (36.7%)
 $\text{MgO} \cdot \text{SiO}_2$ (29.2%)
 $\text{FeO} \cdot \text{SiO}_2$ (17.6%)
 $\text{Al}_2\text{O}_3 \cdot \text{SiO}_2$ (9.6%)
 $\text{TiO}_2 \cdot \text{SiO}_2$ (6.9%)
 Olivine - 15%
 $2\text{MgO} \cdot \text{SiO}_2$ (56.6%)
 $2\text{FeO} \cdot \text{SiO}_2$ (42.7%)
 Anorthite - 20%
 $\text{CaO} \cdot \text{Al}_2\text{O}_3 \cdot \text{SiO}_2$ (97.7%)



Water (? , >1000 ppm)
 Solar Wind
 Hydrogen (50 - 100 ppm)
 Carbon (100 - 150 ppm)
 Nitrogen (50 - 100 ppm)
 Helium (3 - 50 ppm)
 ^3He (4 - 20 ppb)

Lunar Resources

- Oxygen is the most abundant element on the Moon – 42% of the regolith
- Solar wind deposited volatile elements are available at low concentrations
- Metals and silicon are abundant
- Water may be available at poles
- Lunar mineral resources are understood at a global level with Apollo samples for calibration

Mars Resources

- Atmospheric gases, and in particular carbon dioxide (95.5 %) , are available everywhere at 6 to 10 torr (0.1 psi)
- Viking and Mars Odyssey data shows that water is wide spread but spatial *distribution and form of water/ice is not well understood* (hydrated clays and salts, permafrost, liquid aquifers, and/or dirty ice)

Mars Resources

Regolith *

Silicon Dioxide (43.5%)
 Iron Oxide (18.2%)
 Sulfur Trioxide (7.3%)
 Aluminum Oxide (7.3%)
 Magnesium Oxide (6.0%)
 Calcium Oxide (5.8%)
 Other (11.9%)
 Water (2 to >50%)^{xx}
 * Based on Viking Data
^{xx} Mars Odyssey Data

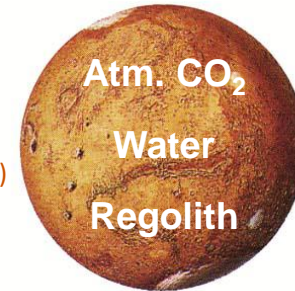

Atmosphere

Carbon Dioxide (95..5%)
 Nitrogen (2.7%)
 Argon (1.6%)
 Oxygen (0.1%)
 Water (210 ppm)

Asteroid Resources



July 30, 2014

Meteorite Types

- **Chondrites (ordinary, enstatite)**
 - Stones, chondrules, olivine, pyroxene, metal, sulfides, usually strong
- **Volatile-rich Carbonaceous Chondrites (CI, CM)**
 - Hydrated silicates, carbon compounds, refractory grains, very weak.
- **Other Carbonaceous (CO, CV, CK, CR, CH)**
 - Highly variable, chondrules, refractory grains, often as strong as ordinary chondrites
- **Achondrites**
 - Igneous rocks from partial melts or melt residues
- **Irons**
 - Almost all FeNi metal
- **Stony-irons**
 - Mix of silicates and metal

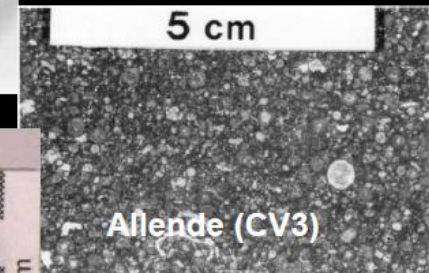
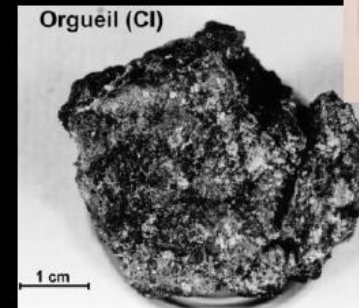
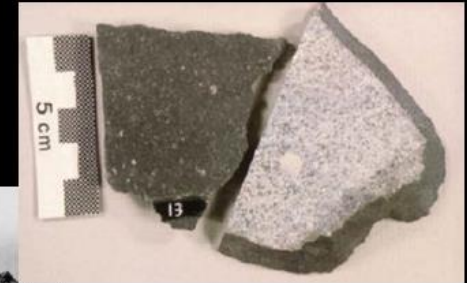

Some Regolith Resources and their Uses

- Lunar oxygen: propellant, life support
- Iron, aluminum, titanium: structural elements
- Magnesium: less strong structural elements
- Regolith: sintered blocks, concrete, glass
- Water: Ice blocks, molded ice

Potential Applications

- Structural beams, rods, plates, cables
- Cast shapes for anchors, fasteners, bricks, flywheels, furniture
- Solar cells, wires for power generation and distribution
- Pipes and storage vessels for fuel, water, and other fluids
- Roads, foundations, shielding
- Spray coatings or linings for buildings
- Powdered metals for rocket fuels, insulation
- Fabrication in large quantities can be a difficult engineering problem in terms of materials handling and heat dissipation

Basalt Rock

Typical chemical compositions of Hawaiian basalts

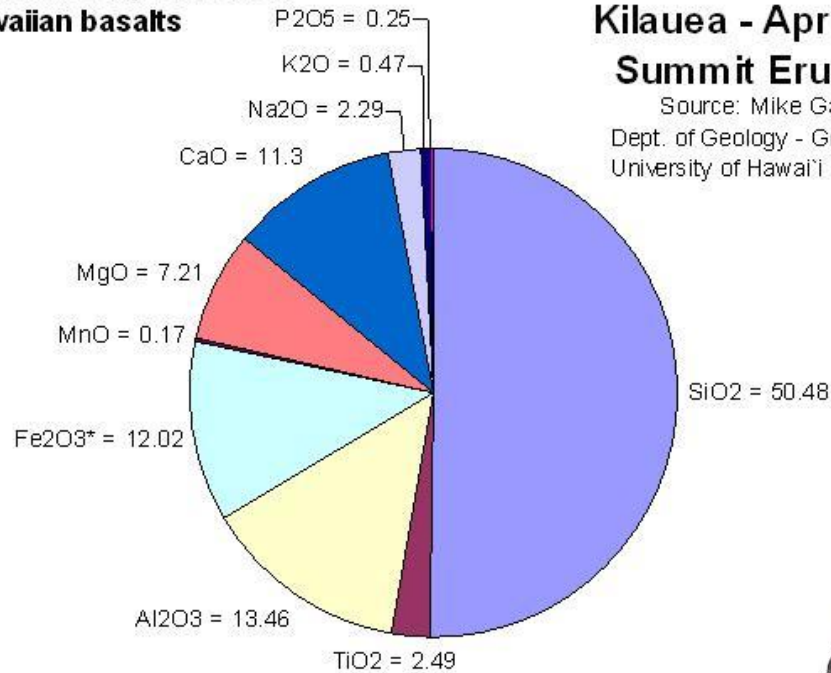

Values represented as total amount per volume

Kilauea - April 1982 Summit Eruption

Source: Mike Garcia
Dept. of Geology - Geophysics
University of Hawai'i at Manoa

Chemical	Element as an oxide
SiO ₂	Silicon
TiO ₂	Titanium
Al ₂ O ₃	Aluminum
Fe ₂ O ₃ *	Iron
MnO	Manganese
MgO	Magnesium
CaO	Calcium
Na ₂ O	Sodium
K ₂ O	Potassium
P ₂ O ₅	Phosphorus

Basalt, a mafic extrusive rock, is the most widespread of all igneous rocks, and comprises more than 90% of all volcanic rocks – it is commonly found on the Moon and Mars



Terrestrial Concrete vs Basalt

Typical properties of normal strength Portland cement concrete are:

- Density : 2500 - 2900 kg/m³ (140 - 150 lb/ft³)
- Compressive strength : ~20 - 40 MPa (~3000 - 6000 psi)

Typical properties of Basalt rock are:

- Density : 2630 +/- 140 kg/m³ (164 lb/ft³)
- Compressive strength : ~144 - 292 MPa (20,885 – 42,351 psi)

Basalt rock can be 4-7 X stronger in compression than normal Portland cement concrete typically used on Earth.

How can basalt rock be formed to be comparable to concrete as a construction material?

Sintered basalt regolith has achieved **206 Mpa (30,000 psi) in compression tests**
(ref: KSC Swamp Works with PISCES, Hawaii collaboration)

5X stronger than Portland Cement concrete – **turning regolith into rock!**

Lunar Regolith Definition



Regolith: Surficial layer covering the entire lunar surface ranging in thickness from meters to tens of meters formed by impact process – physical desegregation of larger fragments into smaller ones over time.

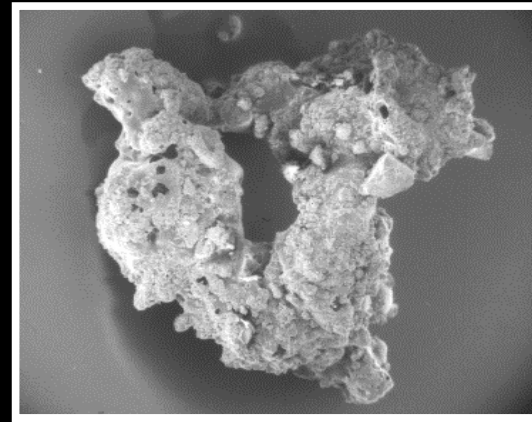
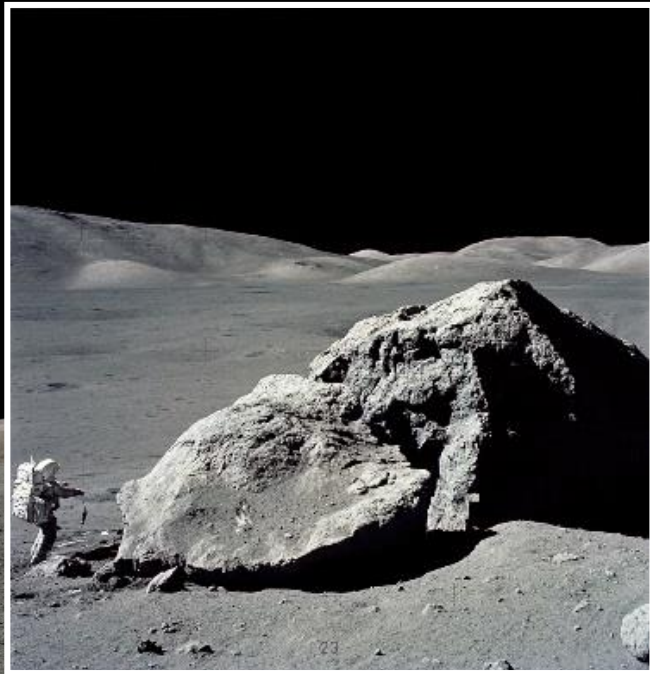



Basalt Granular Material = Construction Material

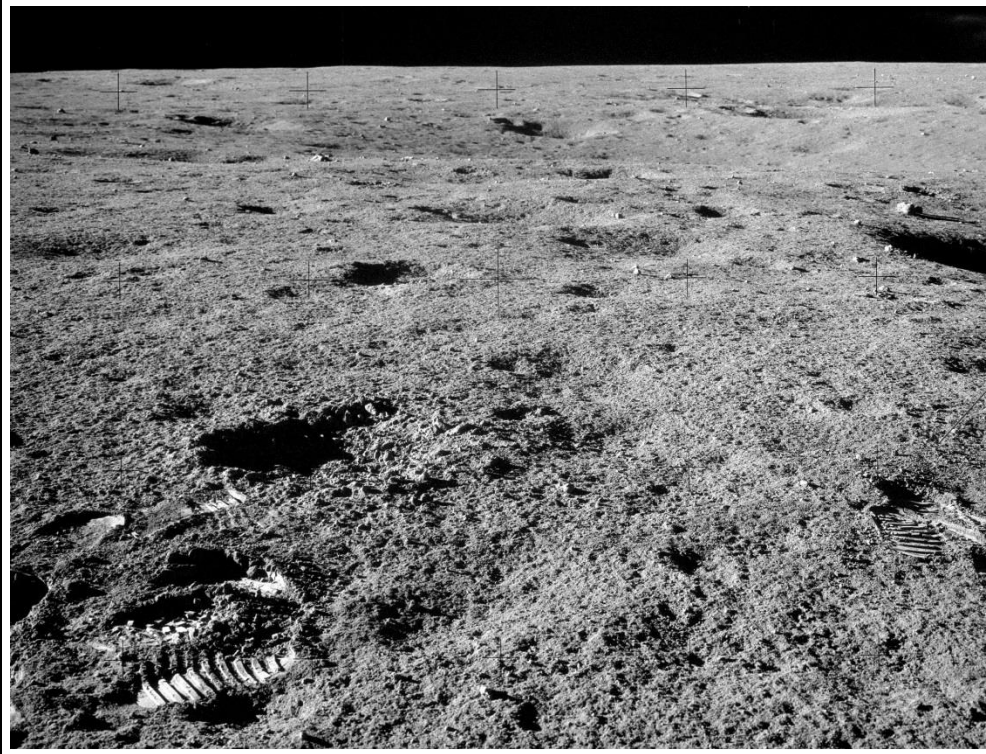

APOLLO 12

APOLLO 16

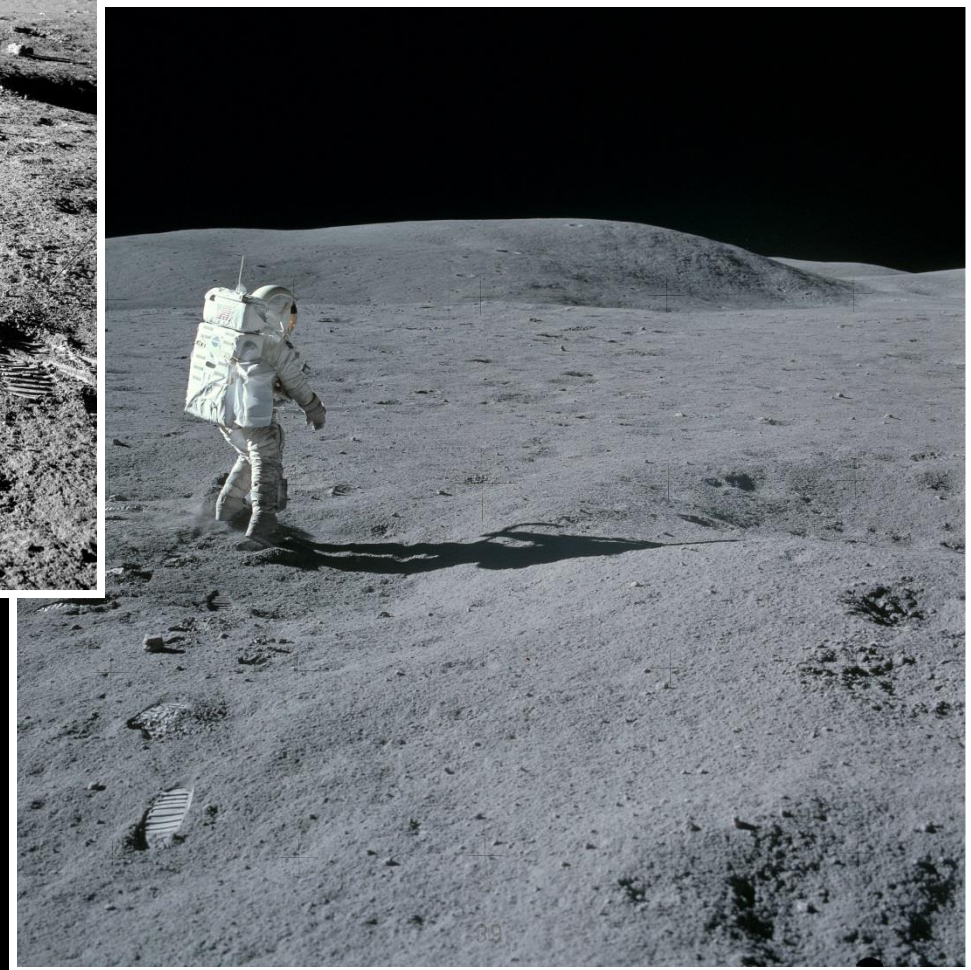



Soil Structure

- Relative to Lunar Soil NEAs have....
- Much higher thermal inertia, much lower gravity
- Expect courser soils, more boulders
- Micro-impacts and regolith gardening can result in size segregation. The solar wind may deplete the smallest size fraction and the larger materials are preferentially retained on the surface of the asteroid.
- Fine materials may be retained at depth in the soil profile.



Mars is full of Regolith Fines



The Moon

- Gravity $\sim 1/6$ of Earth G
- Hard vacuum (1×10^{-12} torr)
- Large temperature swings (especially at Equator)
- Long night (~ 14 Earth-days)
- Very dusty
- Sharp, angular soil with high glass content
 - Very abrasive, electrostatically charged, 100 micron and less
- Soil very compacted below top 2-3 cm layer
 - But we don't know about compaction in the polar craters
- Unprotected from space particle radiation
- Solar flux same as at Earth
- Heating comes almost entirely from the Sun (at night the lunar surface is warmed slightly by Earth).

Near Earth Asteroids

- Gravity negligible ($1/1000^{\text{th}}$ of Earth G)
- Hard vacuum
- May be “rubble piles”
- Might have regolith
- Regolith may be denuded of fine particles at the surface; may be gravelly with boulders
- Different types of asteroids
- Unprotected from particle radiation
- Solar flux same as at Earth

Mars

- Gravity $\sim 3/8$ of Earth G
- Atmospheric pressure $\sim 1\%$ of Earth's, but varies seasonally by 30% as it freezes and unfreezes from the polar caps
- Wind only has 1% of force as Earth's wind
- Mars has CO₂ frost & snow
- Sand carried by wind still abrades like on Earth
- Atmosphere mostly carbon dioxide
- Very dusty atmosphere; dust storms, dust devils

Mars, continued

- Radiation environment on the surface is bad
- Soil is weathered, behaves like terrestrial soil
- Soil is diverse
- Geology is complex
- Little is known about subsurface geology
- Mixture of CO₂ and water ice and clathrates
 - Varying mechanical strength
 - Ice is on the surface at high latitudes
 - Ice is near the surface at moderate latitudes
 - Ice is deep beneath the surface at low latitudes

Multiple Sheltering Aspects Needed



Exhaust Plume Protection

Thermal Protection

Micro-meteoroid Protection

Radiation Protection

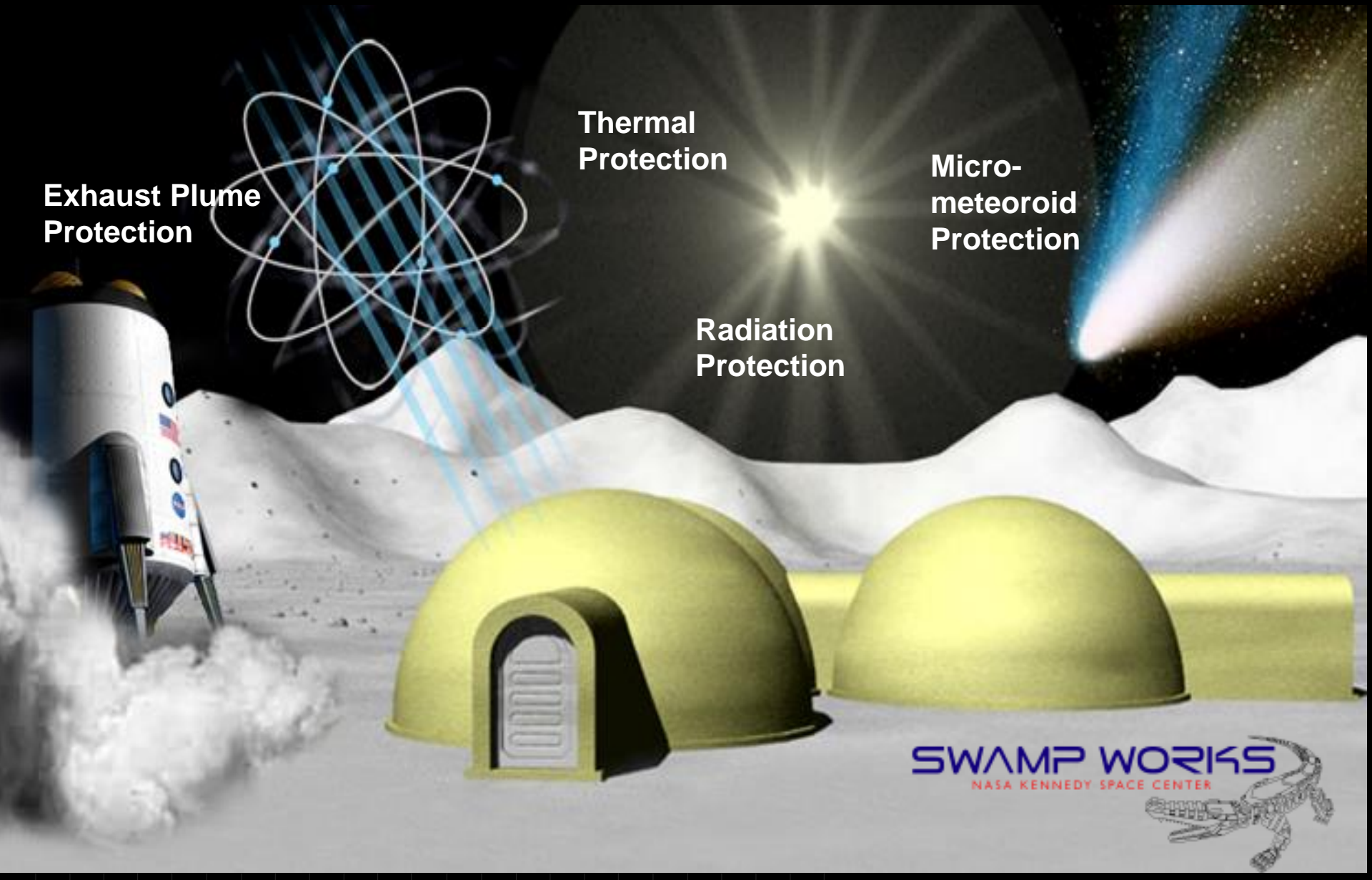

Geotechnical Engineering



- Geotechnical engineering falls within Civil Engineering but very closely aligned with Geological sciences and engineering, as shown below:

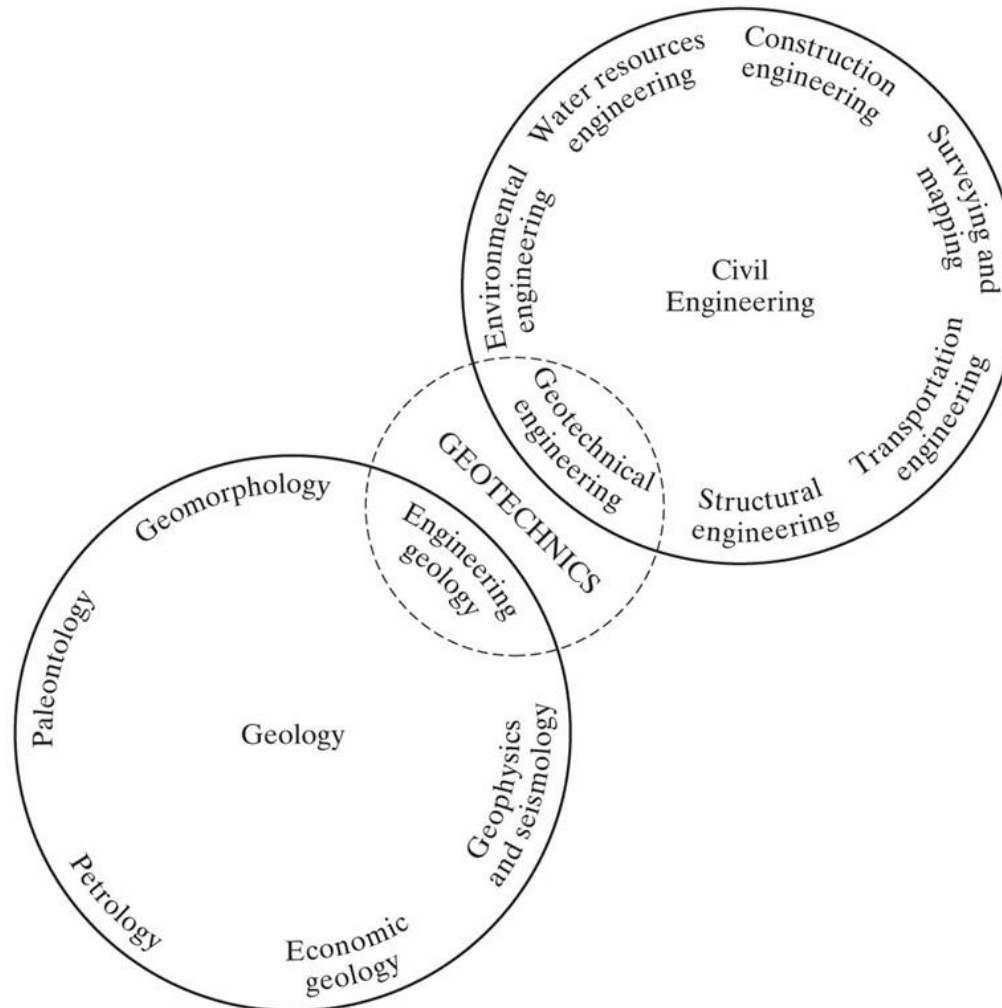

Typical Systems Engineering Process

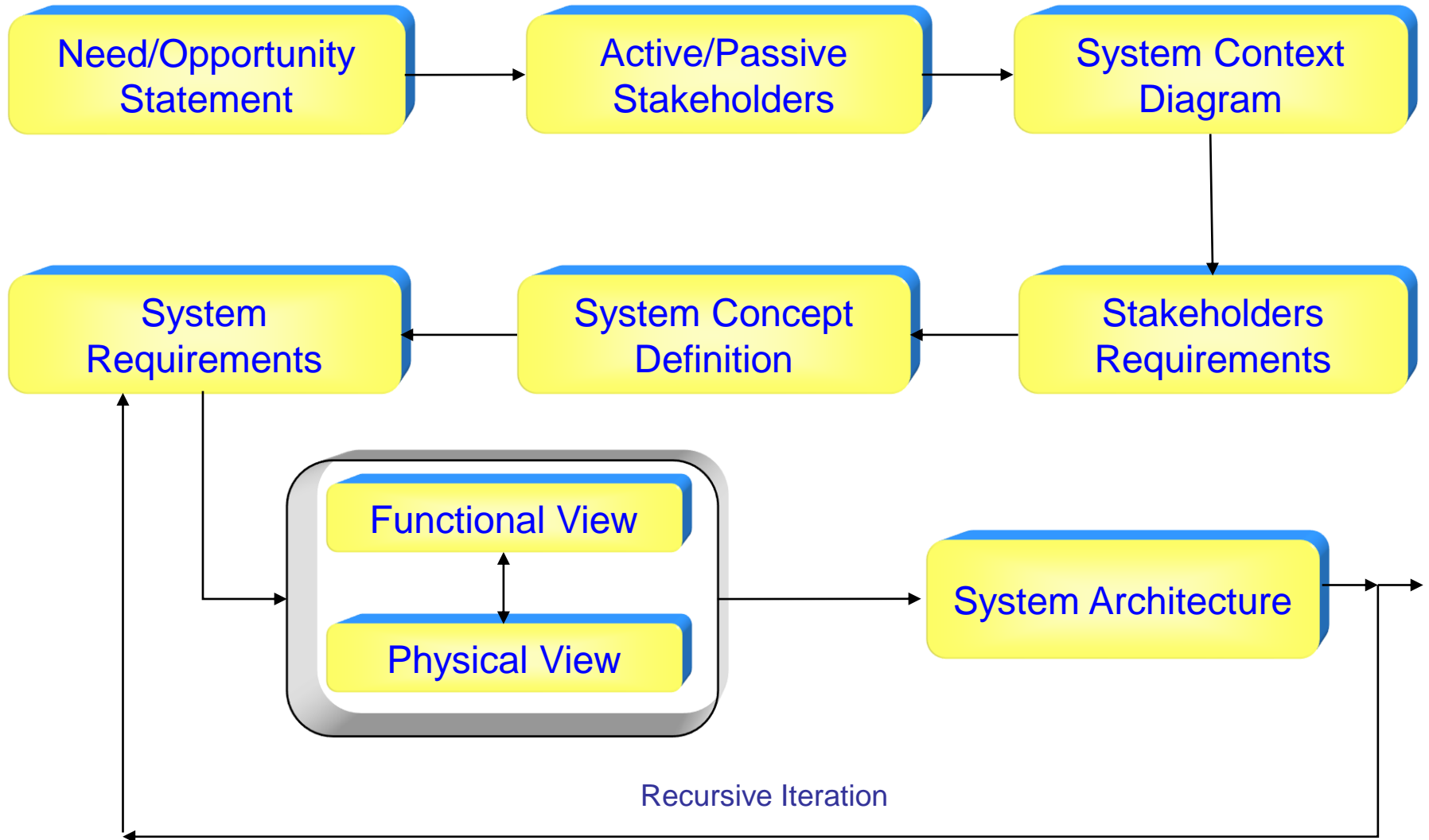



Mars Site Planning: Functional Requirements



13.5 Surface Construction



In-Situ Resource Utilization
13.0

Team 13: In-Situ Resource Utilization

Surface Construction
13.5

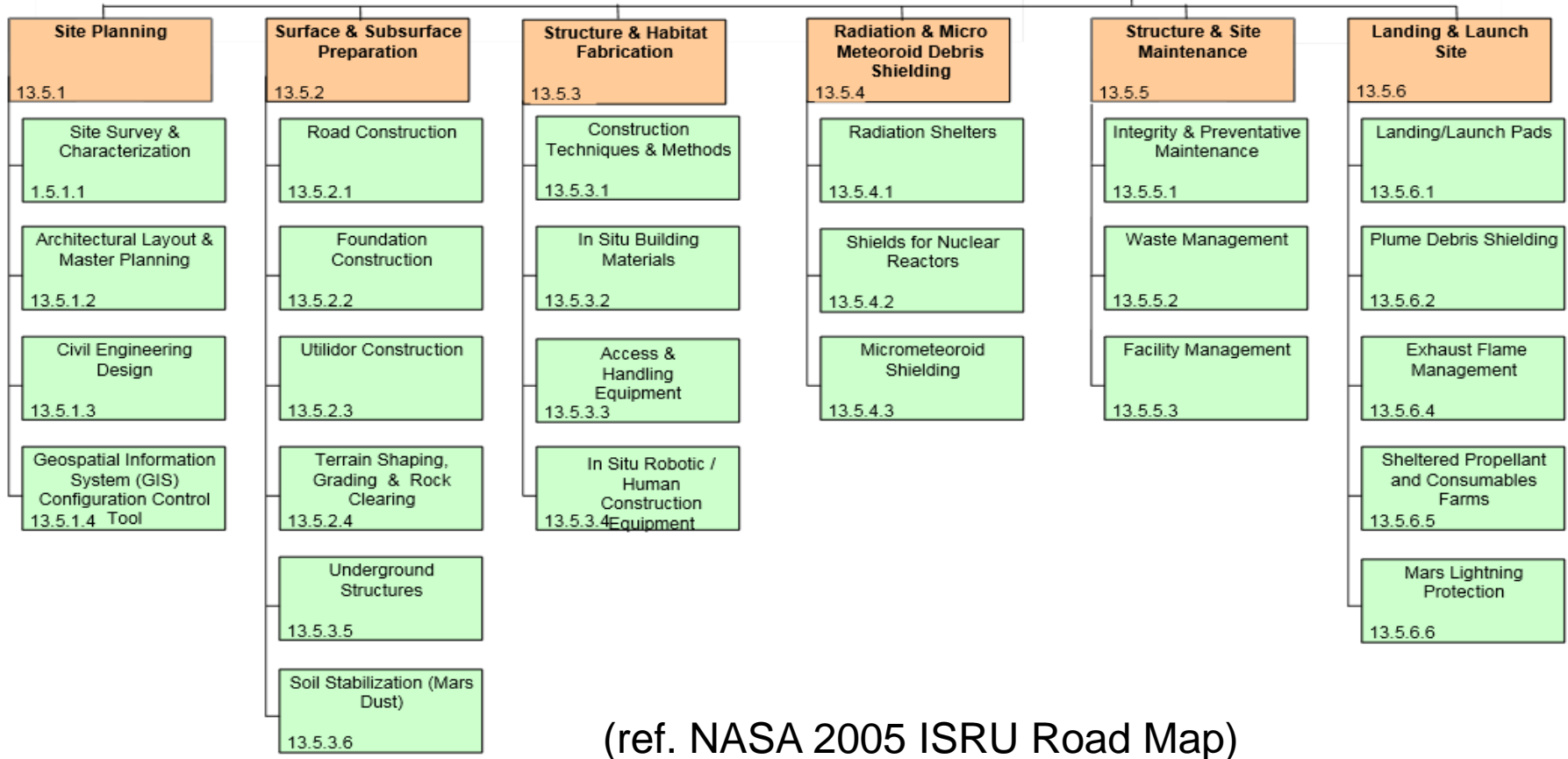

(ref. NASA 2005 ISRU Road Map)

Lunar Mission Space Civil Engineering Capability Concepts



Resource Prospecting – Looking for Resources

Excavation & Regolith Processing for H₂ & O₂ Production, Binders & Aggregates

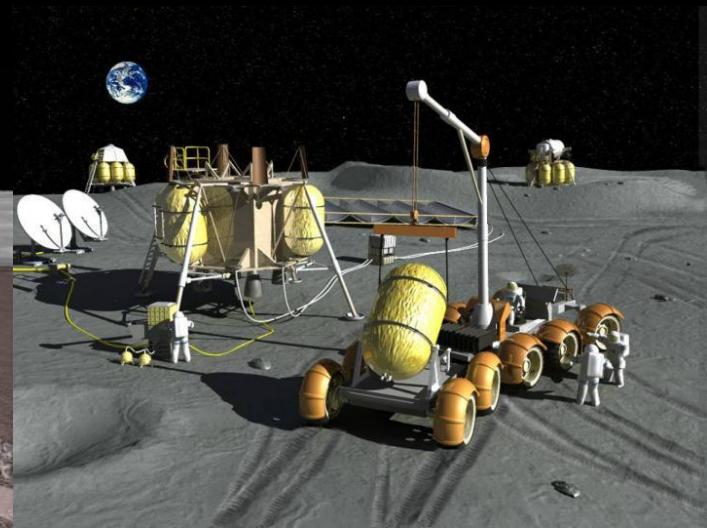
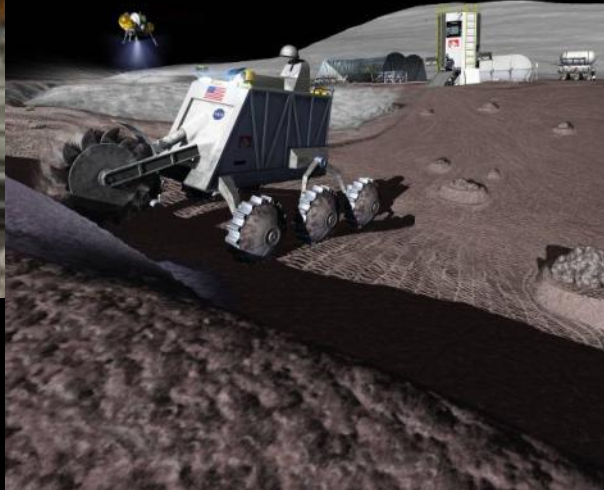

Propellant Processing with Lander & Pad Infrastructure

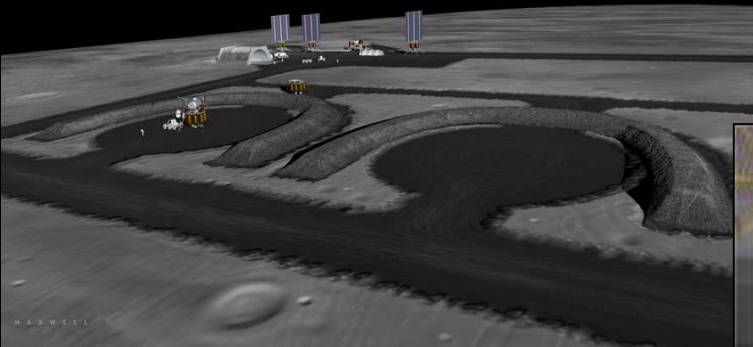

Habitat, Hangars, Dust Free Zones, Landing Pads, Berm, and Road Construction

Thermal Energy Storage Construction

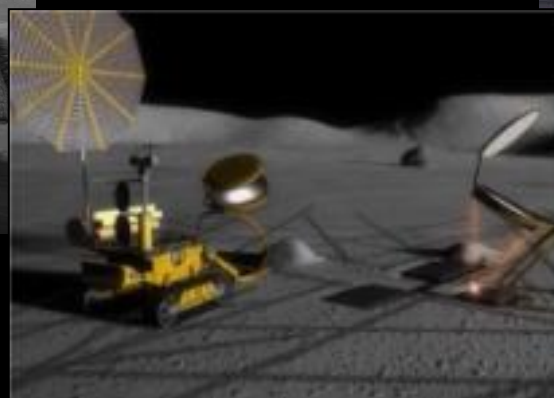

Construction of Consumables Depots for Crew & Power (O₂, H₂)

Planetary Surface Construction Tasks



Launch/Landing Pads

Beacon/Navigation Aids

Lighting Systems

Communications Antenna Towers

Blast Protection Berms

Perimeter Pad Access & Utility Roads

Spacecraft Refueling Infrastructure

Power Systems

**Radiation, Thermal & Micro Meteorite
Shielding**

**Ablative Regolith Atmospheric Entry
Heat Shields**

**Radiation Shielding for Fission Power
Plants**

Electrical Cable/ Utilities Trenches

Foundations / Leveling

Trenches for Habitat & Element Burial

Regolith Shielding on Roof over Trenches

Equipment Shelters

Maintenance Hangars

Dust free zones

Thermal Wadi's for night time

Radiation shielding panels for spacecraft

Regolith Mining for O₂ Production

**H₂O Ice/Regolith Mining from Shadowed
Craters**

Specific Examples: Types of Structures



Habitats

- Landed self-contained structures
- Rigid modules (prefabricated/*in situ*)
- Inflatable modules/membranes (prefabricated/*in situ*)
- Tunneling/coring/ trenches/underground
- Exploited caverns/ lava tubes

Storage Facilities/Shelters

- Open tensile (tents/awning)
- Interlocking Elements with standard interfaces
- Modules (rigid/inflatable)
- Trenches/underground
- Ceramic/masonry (arches/tubes)
- Mobile
- Shells

Supporting Infrastructure

- Slabs / foundations (melts/compaction/additives)
- Trusses/frames
- Berms for rocket blast protection

Top Space Regolith Construction Technical Challenges*



- Strength of In-situ derived regolith concrete materials
- New construction methods & equipment
- Low reaction force excavation in reduced and micro-gravity
- Operating in regolith dust
- Fully autonomous operations
- Energy re-charging and work flow scheduling
- Encountering sub surface rock obstacles
- Long life cycle (5-10 years) and high reliability required
- Spare parts logistics, manufacturing and repair
- Unknown water ice / regolith composition and deep digging
- Extended lunar night time operation and power storage
- Thermal management
- Robust communications

*(no specific order)

Lunar Master Site Planning Considerations: Example

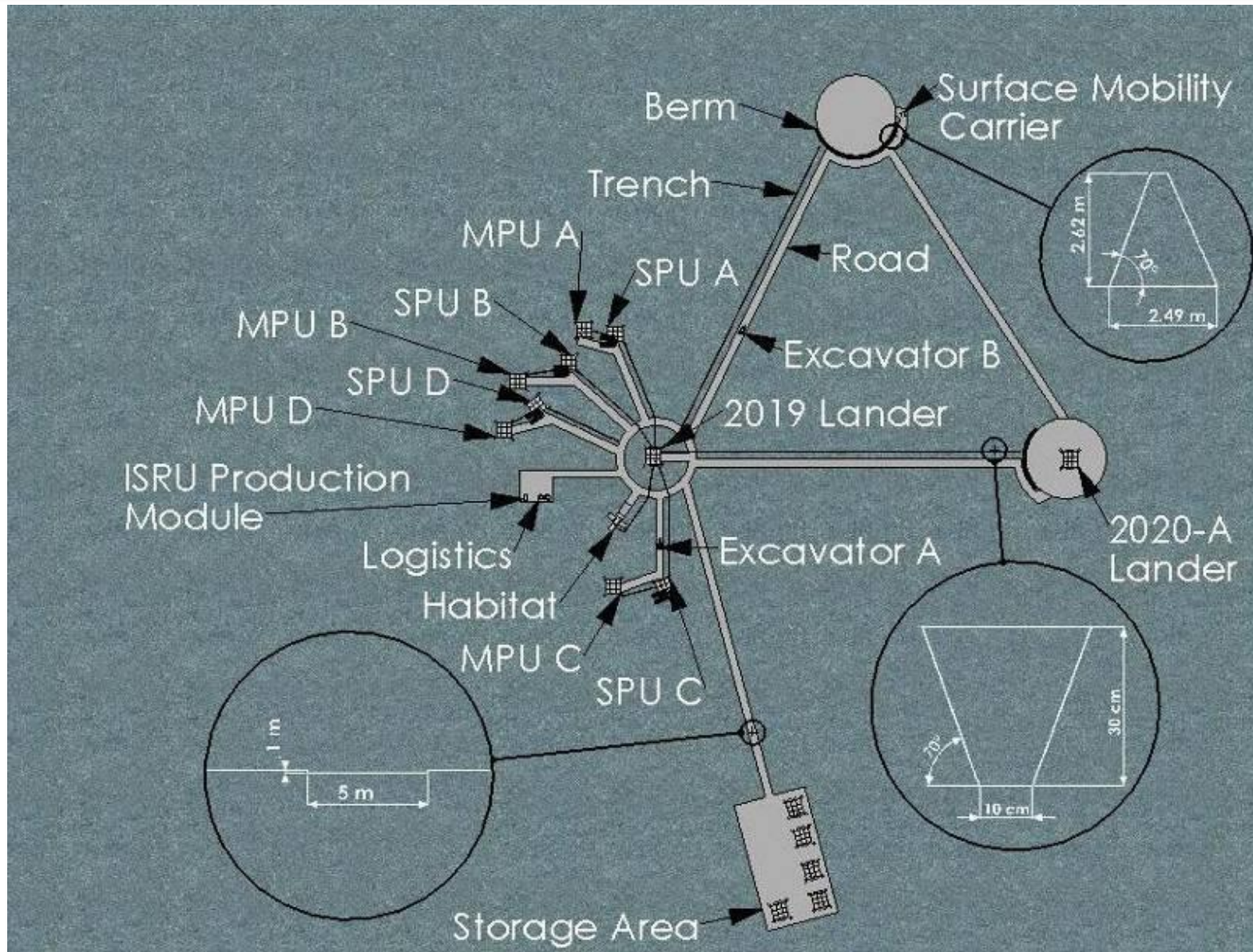

Lunar Base Construction



Build Regolith Based Landing Pads and Berms for safe Vertical Take Off & Vertical Landing (VTVL) Operations

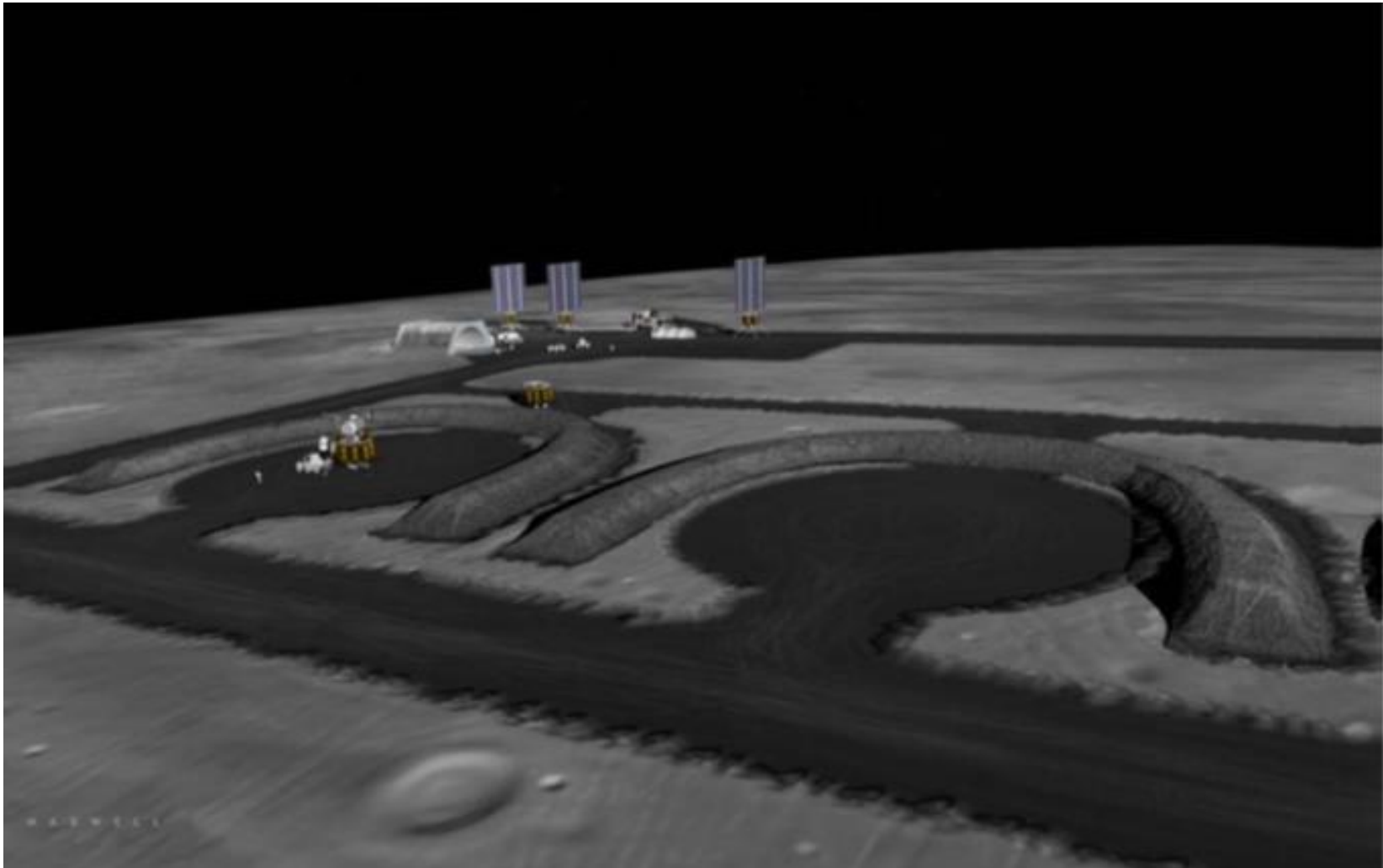

NASA Artwork by Maxwell

Lunar Surface Construction Tasks

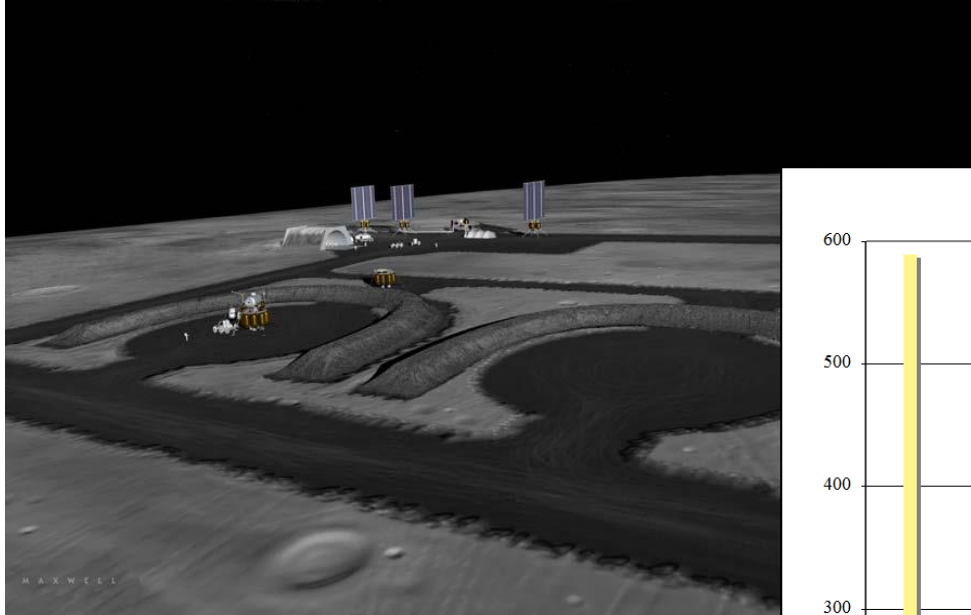

Criteria for Lunar Outpost Excavation
 R. P. Mueller and R. H. King
 Space Resources Roundtable –SRR IX
 October 26, 2007
 Golden, Colorado

SUMMARY	
Task	%
Trenching	4
Clearing and Compacting	48
Building Berms	18
Habitat Shielding	31
	100
Ice Mining	17
Regolith Mining	83
Construction	84
Mining	16

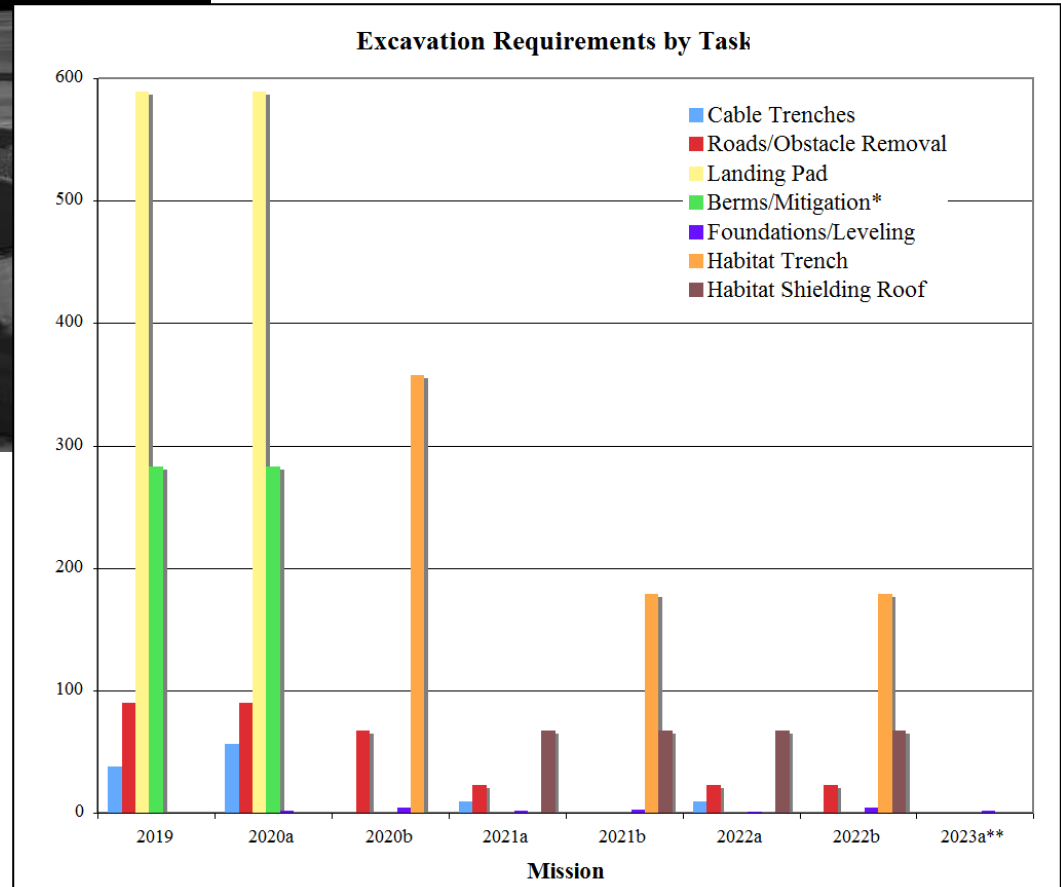

Robotic Functional Decomposition



TA4.0 Robotics, Tele-Robotics & Autonomous (RTA) Systems

TA4.1 Sensing & Perception

TA4.1.1
3-D Perception

TA4.1.2
Relative Position & Velocity Estimation

TA4.1.3
Terrain Mapping, Classification & Characterization

TA4.1.4
Natural & Man-made Object Recognition

TA4.1.5
Sensor Fusion for Sampling & Manipulation

TA4.1.6
Onboard Science Data Analysis

TA4.2 Mobility

TA4.2.1
Extreme Terrain Mobility

TA4.2.2
Below-Surface Mobility

TA4.2.3
Above-Surface Mobility

TA4.2.4
Small Body / Microgravity Mobility

TA4.3 Manipulation

TA4.3.1
Robot Arms

TA4.3.2
Dexterous Manipulators

TA4.3.3
Modeling of Contact Dynamics

TA4.3.4
Mobile Manipulation

TA4.3.5
Collaborative Manipulation

TA4.3.6
Robotic Drilling & Sample Processing

TA4.4 Human-Systems Int.

TA4.4.1
Multi-Modal Human-Systems Interaction

TA4.4.2
Supervisory Control

TA4.4.3
Robot-to-Suit Interfaces

TA4.4.4
Intent Recognition & Reaction

TA4.4.5
Distributed Collaboration

TA4.4.6
Common Human-Systems Interfaces

TA4.4.7
Safety, Trust, & Interfacing of Robotic/Human Proximity Operations

TA4.5 Autonomy

TA4.5.1
Vehicle System Management & FDIR

TA4.5.2
Dynamic Planning & Sequencing Tools

TA4.5.3
Autonomous Guidance & Control

TA4.5.4
Multi-Agent Coordination

TA4.5.5
Adjustable Autonomy

TA4.5.6
Terrain Relative Navigation

TA4.5.7
Path & Motion Planning with Uncertainty

TA4.6 Autonomous Rendezvous & Docking

TA4.6.1
Relative Navigation Sensors (long-, mid-, near-range)

TA4.6.2
Guidance Algorithms

TA4.6.3
Docking & Capture Mechanisms/ Interfaces

TA4.6.4
Mission/System Managers for Autonomy/ Automation

TA4.7 RTA Systems Engineering

TA4.7.1
Modularity / Commonality

TA4.7.2
Verification & Validation of Complex Adaptive Systems

TA4.7.3
Onboard Computing

NASA Roadmap 2012

Top Robotic Technical Challenges



- Object Recognition and Pose Estimation
- Fusing vision, tactile and force control for manipulation
- Achieving human-like performance for piloting vehicles
- Access to extreme terrain in zero, micro and reduced gravity
- Grappling and anchoring to asteroids and non cooperating objects
- Exceeding human-like dexterous manipulation
- Full immersion, telepresence with haptic and multi modal sensor feedback
- Understanding and expressing intent between humans and robots
- Verification of Autonomous Systems
- Supervised autonomy of force/contact tasks across time delay
- Rendezvous, proximity operations and docking in extreme conditions
- Mobile manipulation that is safe for working with and near humans

Lunar Excavation System Concepts

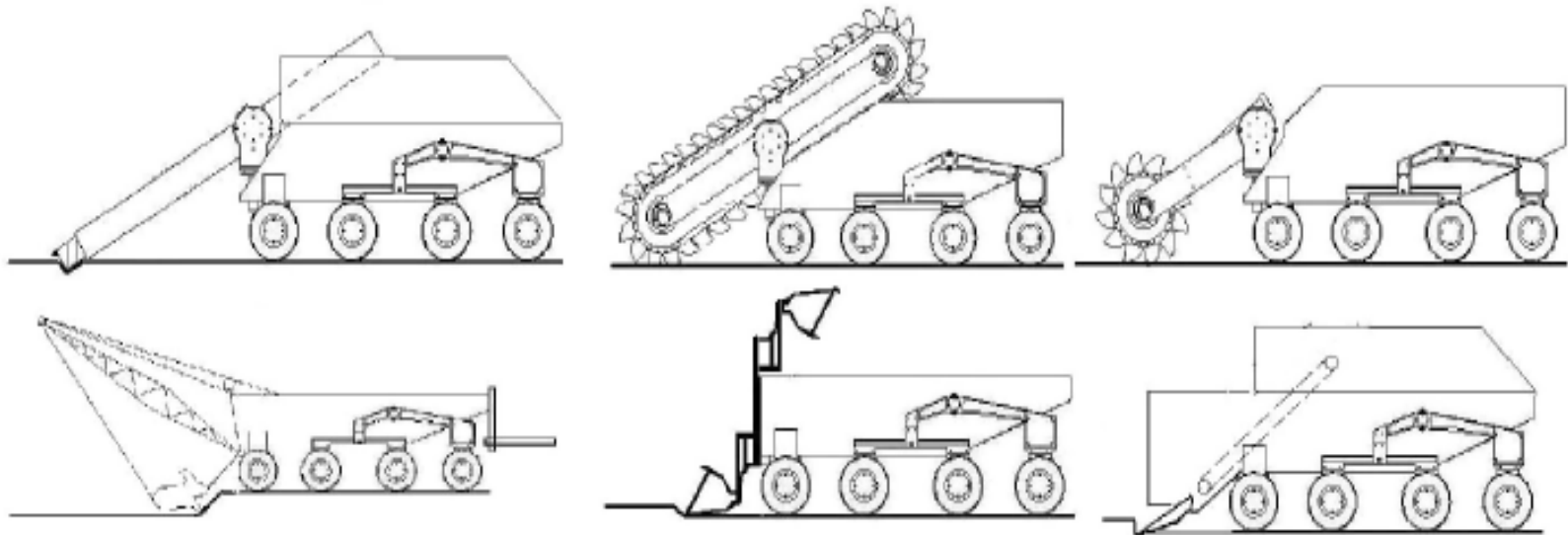

FIGURE 3. Additional Concepts From Top Left to Bottom Right: Auger, Bucket Ladder, Bucket Wheel or Bucket Drum, Dragline, Overshot Loader, and Scraper.

TABLE 4. Summary Estimated Specifications for the Additional Concepts.

	Auger	Bucket Ladder	Bucket Wheel	Dragline	Overshot Loader	Scraper	Pneumatic
Production Cycle	134 min	134 min	134 min	224 min	176 min	176 min	Unknown
Unloaded System Mass	17.8 kg	18.8 kg	19.8 kg	28.8 kg	16.8 kg	14.8 kg	Unknown
Horizontal Reaction Force	11.5 N	12.2 N	12.8 N	18.1 N	10.9 N	5.6 N	Unknown
Vertical Reaction Force	14.4 N	15.3 N	16 N	0.4 N	13.6 N	12 N	Unknown
Subsystems	5	5	6	5	4	4	6
Motor/gear assemblies	14	14	15	24	14	13	5
Material Transfer Points	5	5	6	5	5	6	3

60 Kg Excavator with Small Scoop



Replica of NASA Lunar Surveyor Scoop & Test results in regolith simulants

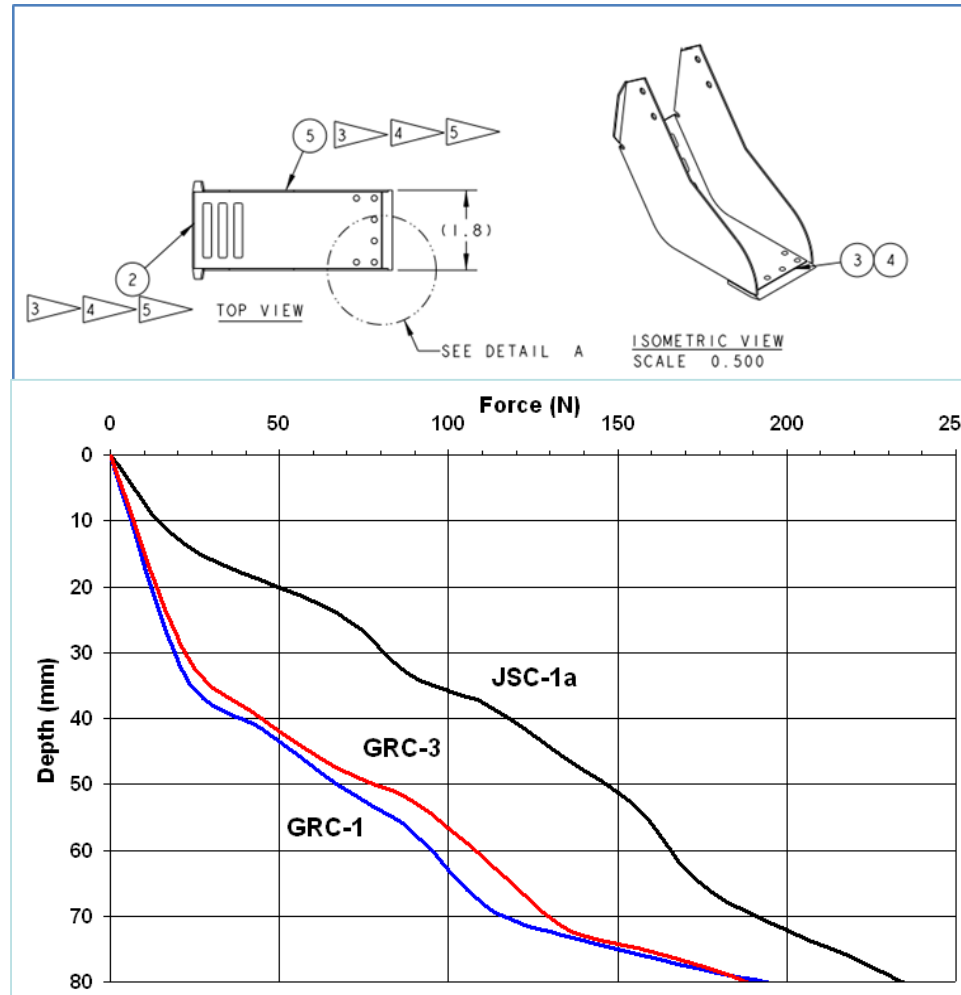



Design Options:

- Increase Traction (Heavier, grousers on wheels)
- Decrease Excavation Forces (Smaller scoops, less depth of cut)
- If a traditional small / lightweight excavator is designed, then the design solution must excavate many small scoops quickly to meet traction constraints and still meet production goals

What is the Best Lunabot Regolith Mining Design for the Moon?? The Most Popular Winning Design? (50-80 Kg)



2009: Paul's Robotics WPI



2010: Montana State U



2011: Laurentian University

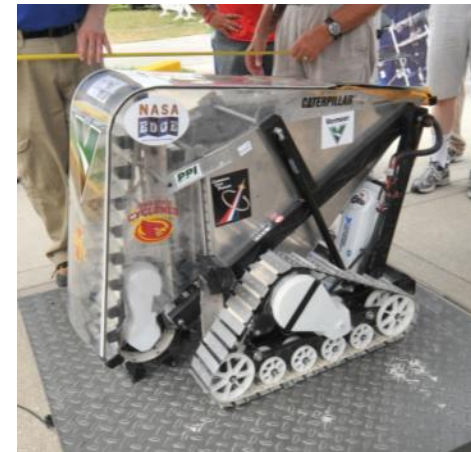

2012: Iowa State U

Or are these designs better?

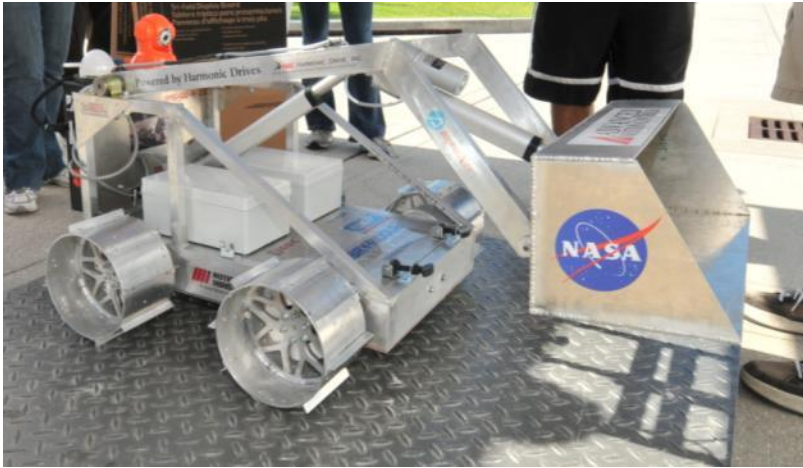

2012: Embry Riddle Daytona AU



2011: U North Dakota

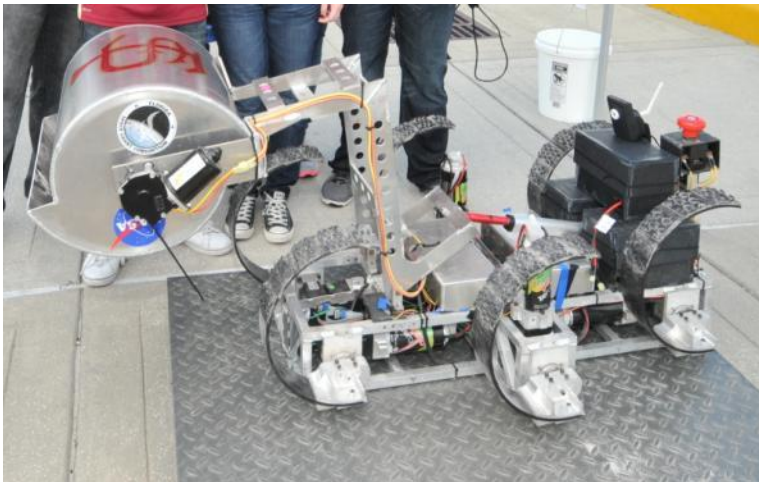

2012: FAMU/ Florida State U



2012: Montana State U

Regolith Excavation Mechanisms

All excavators from three Centennial Excavation Challenge Competitions (2007, 2008 and 2009) and two Lunabotics Mining Competitions (2010 and 2011)



Regolith Excavation Mechanism	# of machines employing excavation mechanism
Bucket ladder (two chains)	29
Bucket belt	10
Bulldozer	10
Scraper	8
Auger plus conveyor belt / impeller	4
Backhoe	4
Bucket ladder (one chain)	4
Bucket wheel	4
Bucket drum	3
Claw / gripper scoop	2
Drums with metal plates (street sweeper)	2
Bucket ladder (four chains)	1
Magnetic wheels with scraper	1
Rotating tube entrance	1
Vertical auger	1

Astrobotic Technology inc. Lunar Mining Concepts NASA SBIR 2010-2012



Video

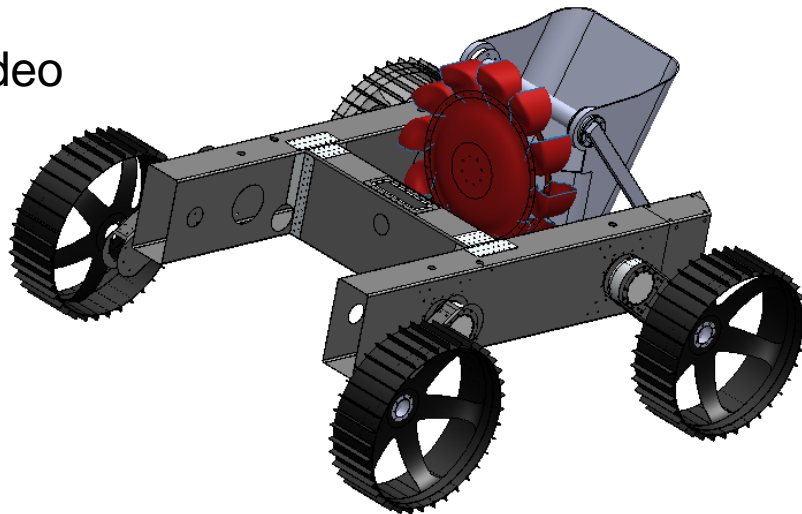

NASA KSC Swamp Works Regolith Advanced Surface Systems Operations Robot (RASSOR)

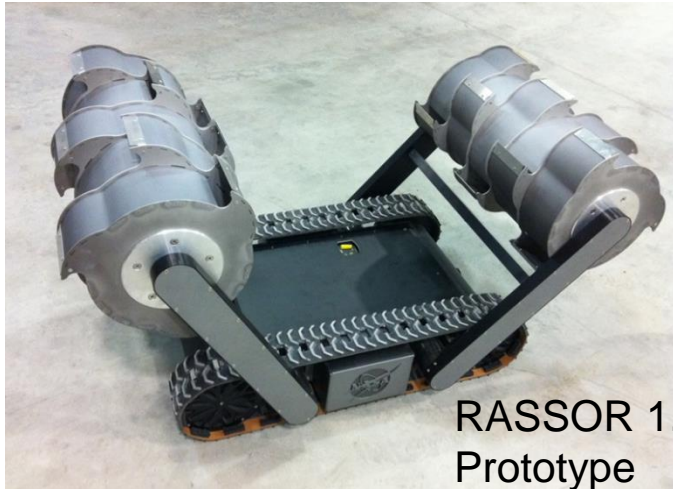

RASSOR 1.0
Prototype



RASSOR 1.5
Prototype

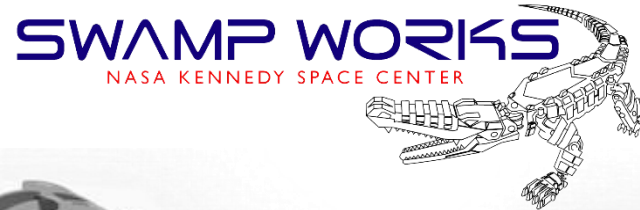

Video



RASSOR 2.0 Prototype

Dry Mass ~ 66 Kg

Regolith Payload = 80 Kg

Counter-Rotating Bucket Drums = Zero Net Reaction Force

Excavator: RASSOR 2.0



Excavator: RASSOR 2.0

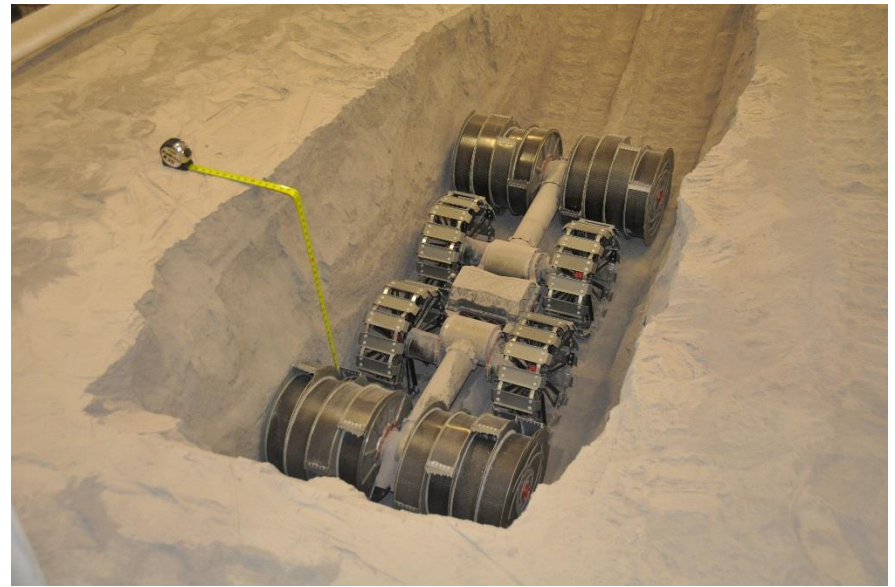

Video

Bucket drum torque test setup

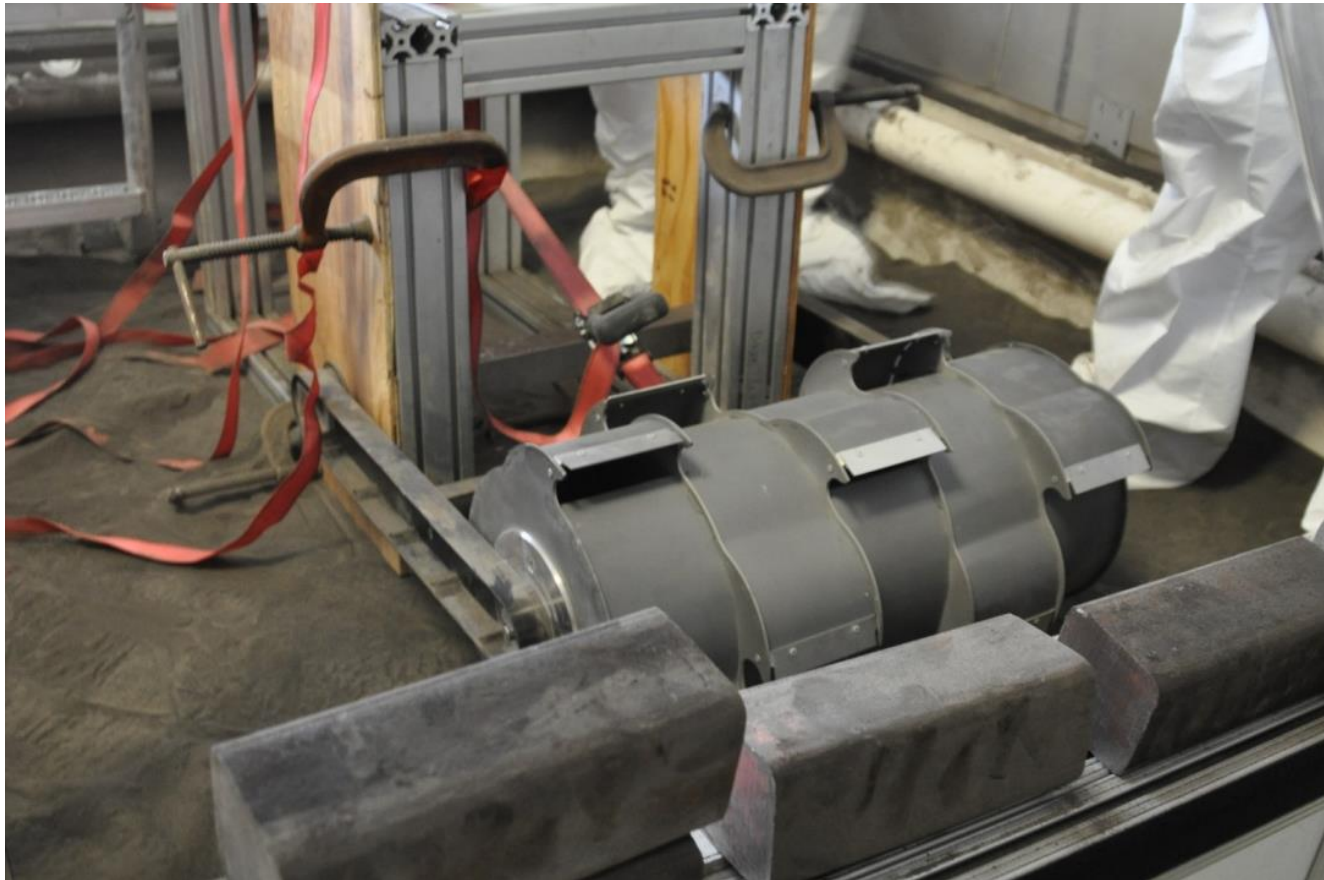

Bucket Drum Torque Test (N m).

Cutting Depth (cm)	Test 1	Test 2	Test 3	Test 4	Avg.	Force (N)
2.66	47.45	33.89	40.67	33.89	38.98	220.09
1.77	20.34	20.34	20.34	13.56	18.64	105.26

~275 N Digging Force @ 4 cm depth

Launch / Landing Pad Construction



Construct a Launch/Landing Pad using In Situ Regolith for rocket plume impingement mitigation

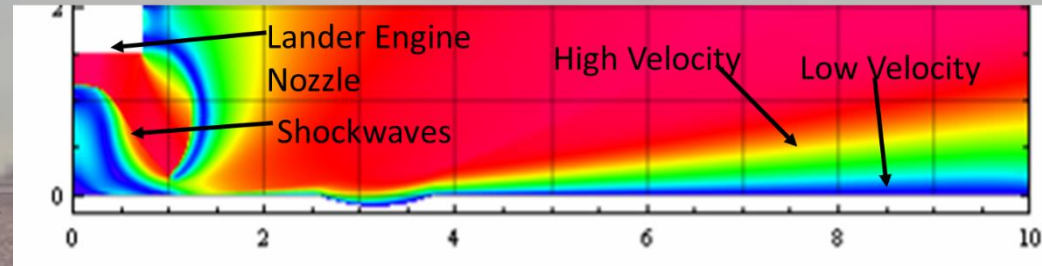

NASA Photo: Morpheus Project



Photo Credits: PISCES /NASA ACME

NASA/ PISCES Paver Laying Robot



Hawaii PISCES Rover on Mauna Kea with Payloads 44



ISRU Process Waste



Use of waste stream from In-Situ Resource Utilization (ISRU) processes.

- Hot regolith can be poured into a heat shield mold.
- Saves energy by combining processes.

Hot Hawaiian tephra output from the ROxygen generation I oxygen production reactor.

This basalt regolith material can be used to make parts and pavers for lunar structures

Regolith Sintering Process

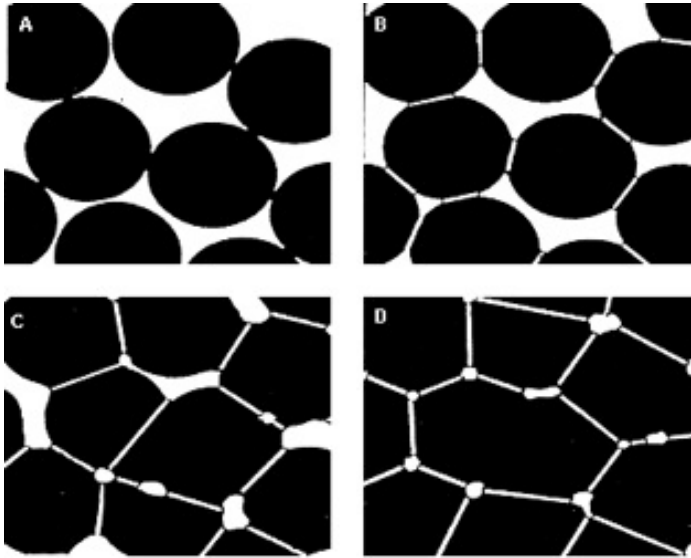

Temperature and heating time are crucial factors in resulting structure.

Sintered Basalt Regolith results in a high temperature resistant material that can be used for launch/landing pad materials

JSC-1A sintered tiles that have been exposed to a rocket plume for a lander vehicle
(Courtesy Swamp Works, NASA KSC)



Sintered Basalt Pavers

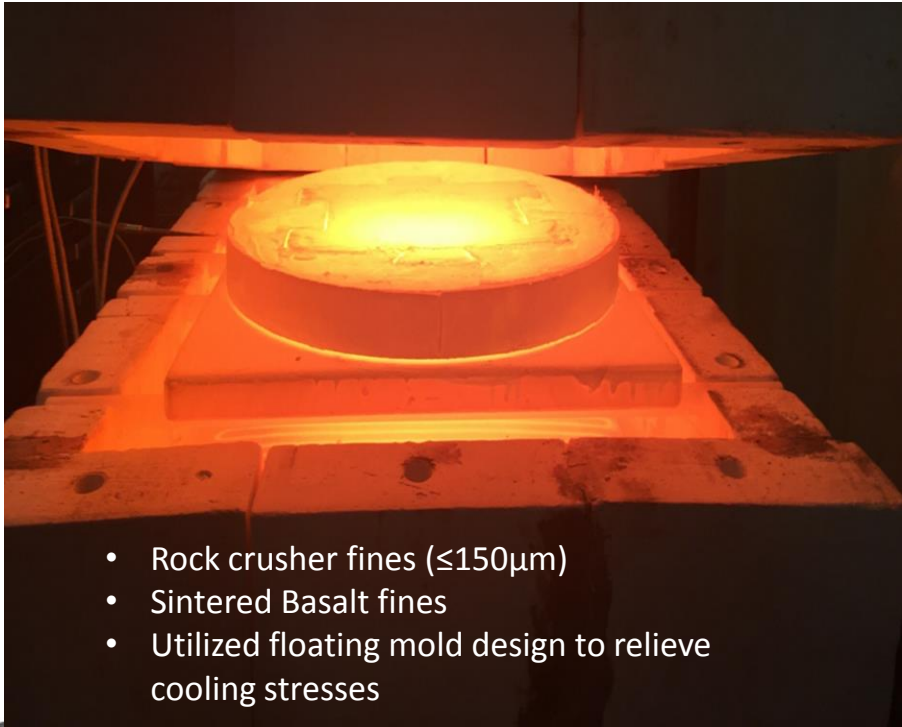

PACIFIC INTERNATIONAL SPACE CENTER FOR
EXPLORATION SYSTEMS | PISCES.HAWAII.GOV



PISCES Rover, Helelani: Multi Purpose Vehicle. Mobile Platform Base: Alpha Argo Rover

Grading & Leveling Blade



Compactor Roller



Paver Deployment Mechanism

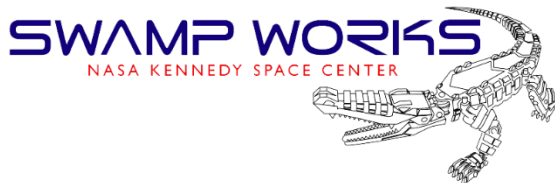

Launch / Landing Pad Construction

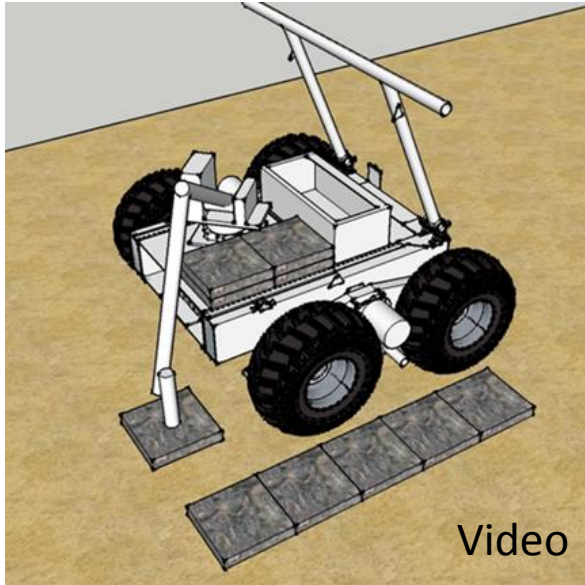

Hawaiian Hot Fire Test!



Photo Credits: PISCES / NASA ACME

~1,000 lbf Thrust, "M" Class Solid Rocket Motor Firing in test stand
Paver cracking led to new, improved sintered basalt material being developed

Robotic 3D Additive Construction using Regolith Concrete

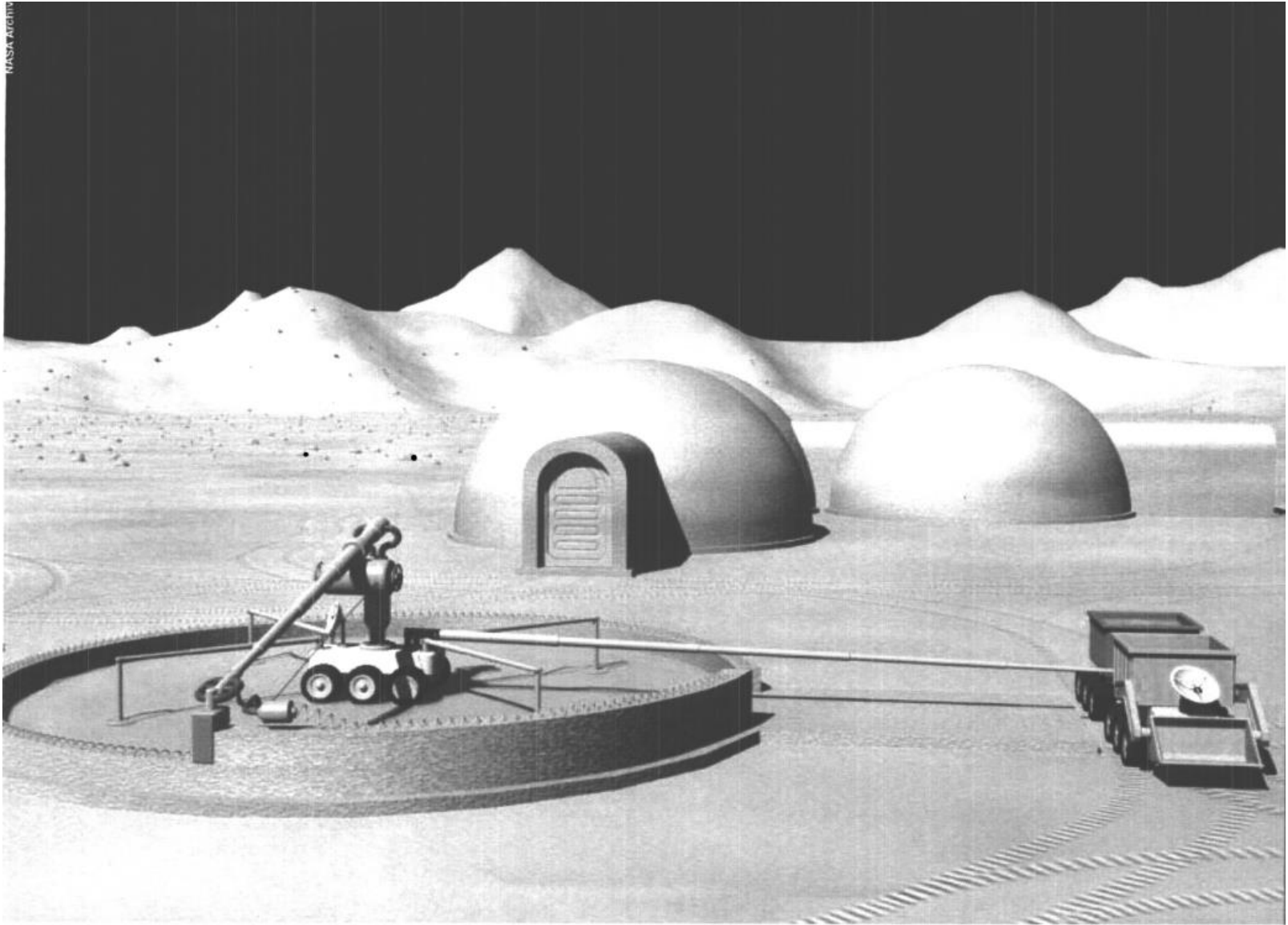

3D Additive Construction with Regolith Concrete



Multi-axis print head

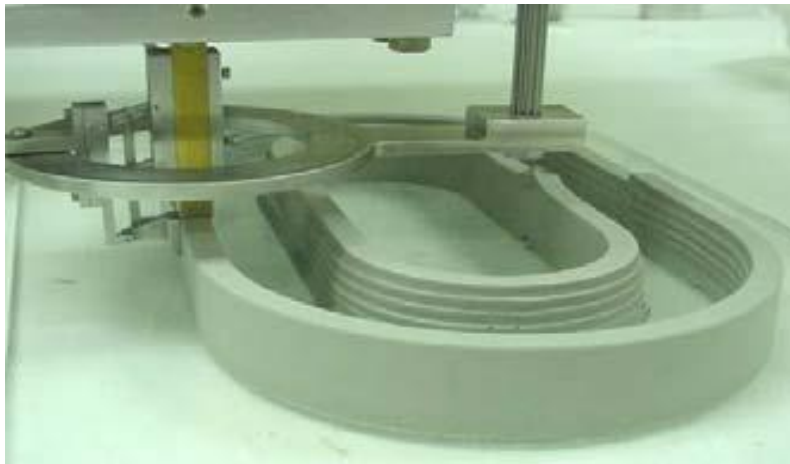

Curved wall tool path development

Images Courtesy of Dr. B. Khoshnevis, Contour Crafting, LLC for NASA NIAC

3D Additive Construction Elements Using In-Situ Materials (Basalt)



Images Courtesy
of Dr. B. Khoshnevis,
Contour Crafting, LLC for NASA NIAC

NASA / USC Additive Construction with Mobile Emplacement (ACME)



Bench Top Test Results

Successful laser based fabrication of test materials and bench-top scale freestanding structures was achieved with several types of regolith simulant including:

- Black Point -1 (BP-1), Lunar Regolith Basalt Simulant – NASA KSC
- JSC-1A, Lunar Mare Simulant – NASA Johnson Space Center (JSC)
- NU-LHT-2M, Lunar Highland Type Simulant (2 Medium) – NASA USGS
- Hawaiian Basaltic Tephra from Mauna Kea Volcano, Hai Wahine Valley
- Standard White Construction Sand with 30% by weight added BP-1
- Cape Canaveral “Jetty Park” Beach Sand with 30% by weight added BP-1

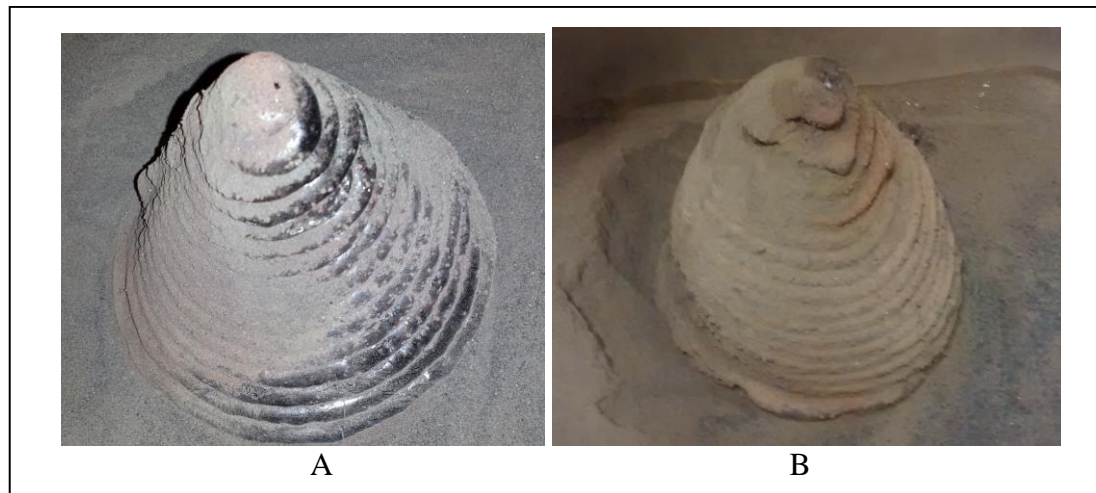
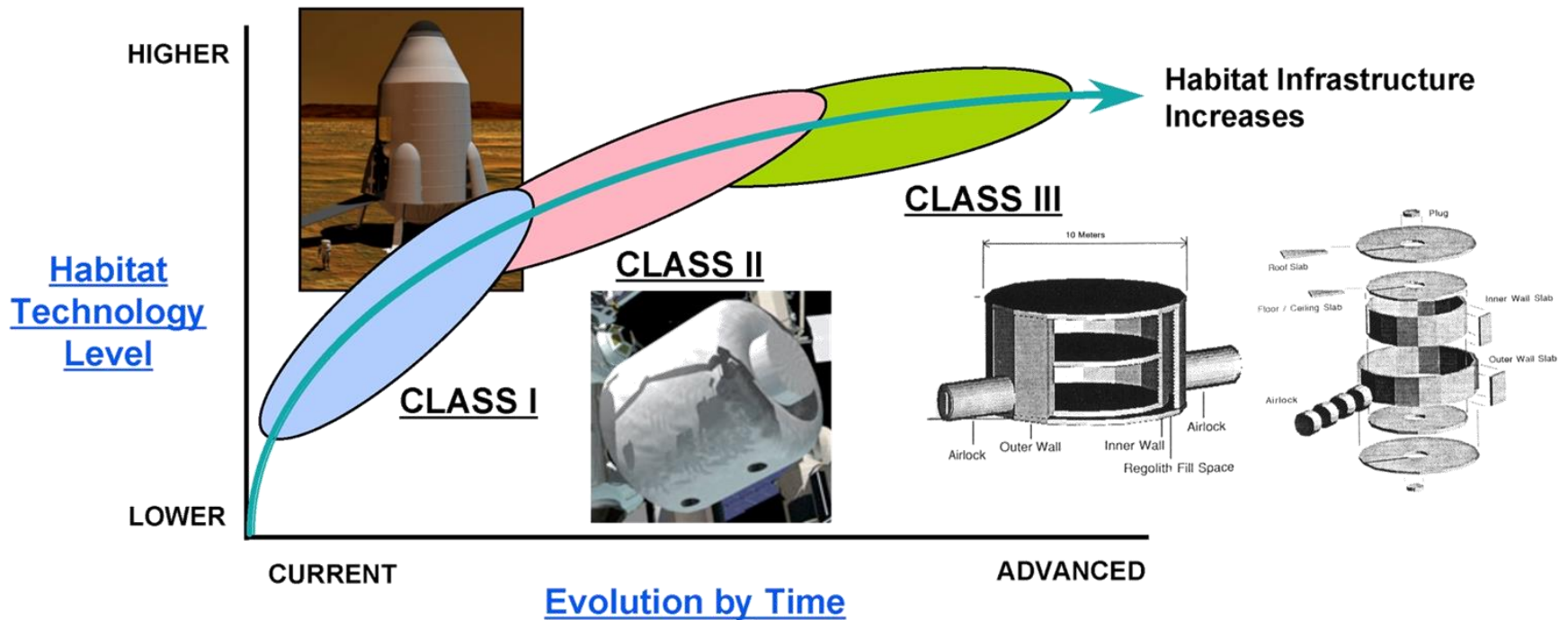

Figure 2. Bench-top scale freestanding structures created by Swamp Works 3D Regolith Construction process: **A) BP-1 Hollow Cone Structure; B) BP-1 Hollow Ogive Dome Structure**

Phased Approach to Space Construction

- **CLASS I:**
 - Preintegrated, Hard Shell Module
- **CLASS II:**
 - Prefabricated, Surface Assembled
- **CLASS III:**
 - ISRU Derived Structure w/ Integrated Earth components



Class I: Pre-integrated Construction

- Fully usable
- No assembly required
- Limited by payload size

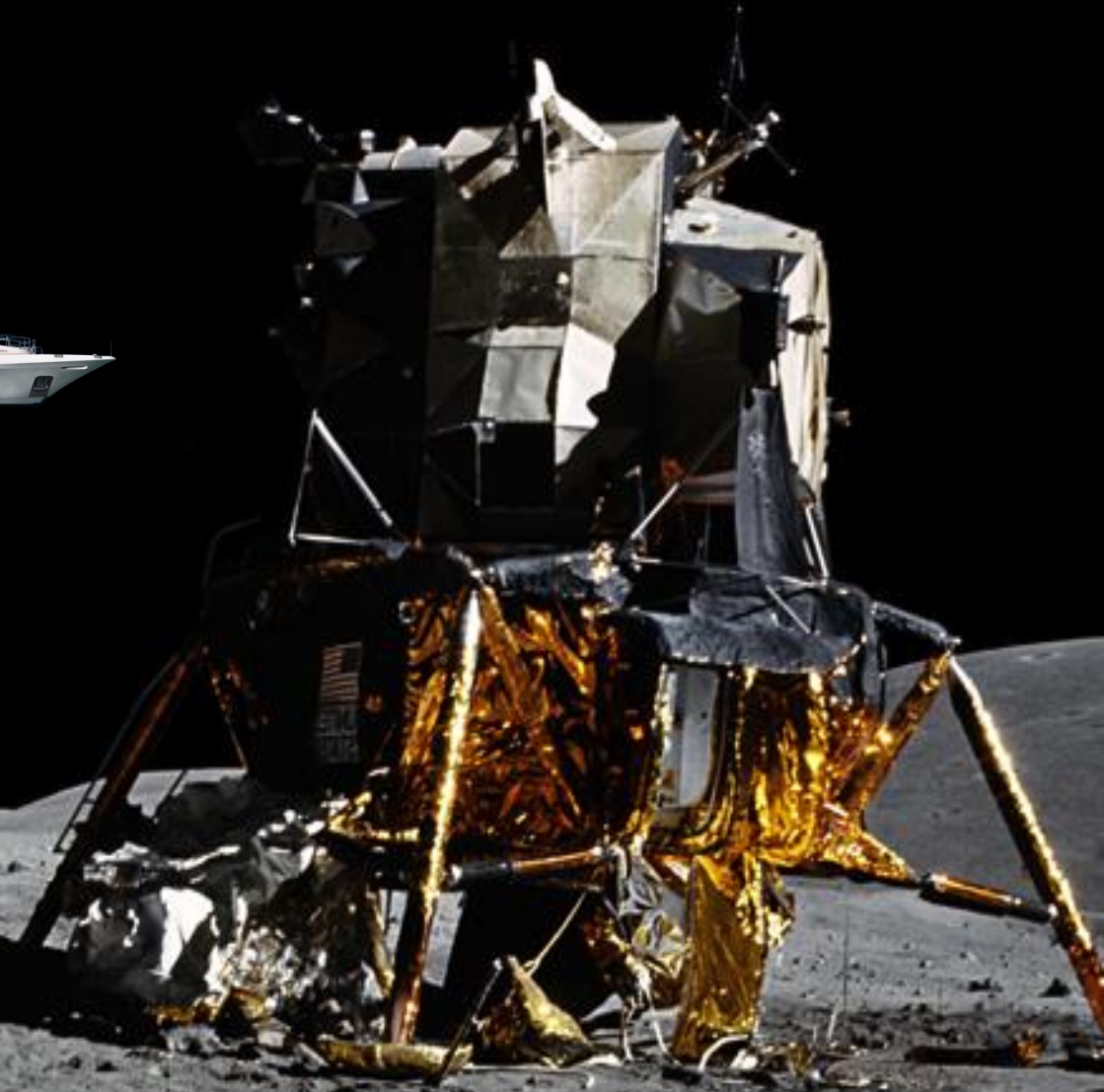
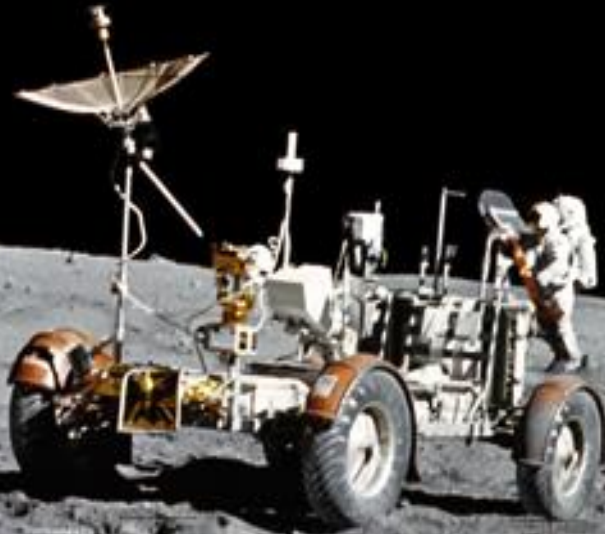

Apollo 16 LM (courtesy NASA)

Class II: Pre-fabricated Construction

- Assembled onsite
- Robust joints
- Replacable
- No size limit

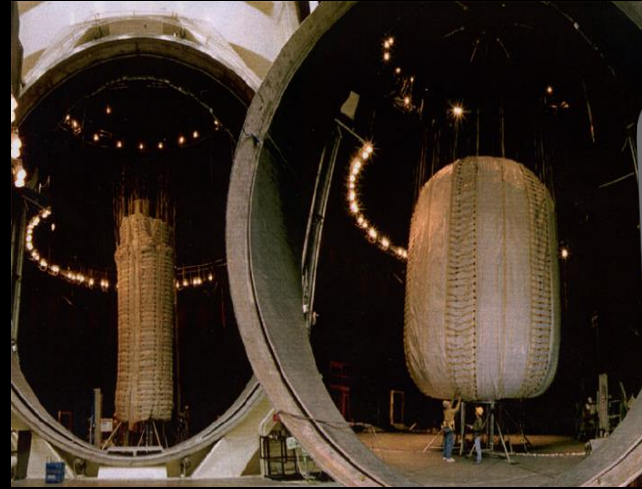

TransHab (courtesy NASA)

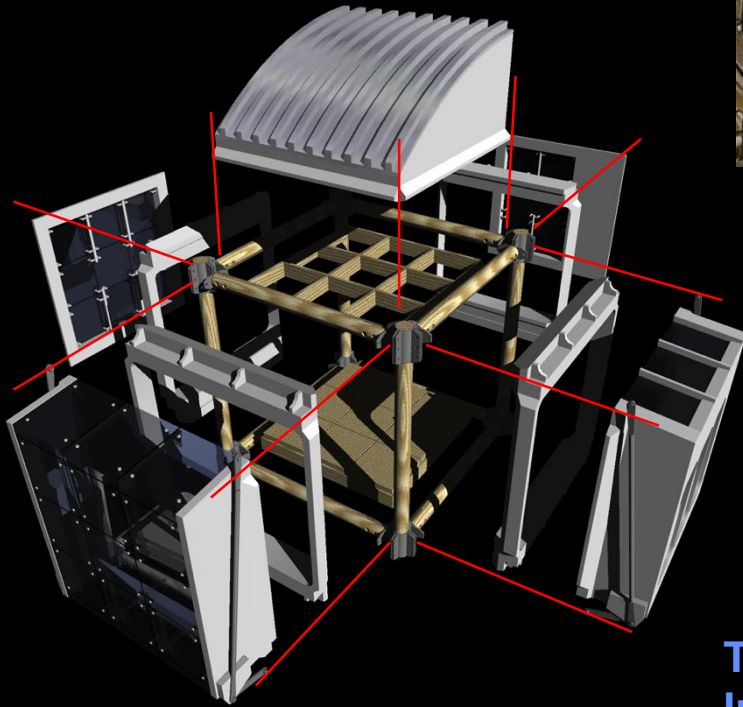

Transformable Robotic
Infrastructure-Generating
Object Network (TRIGON)

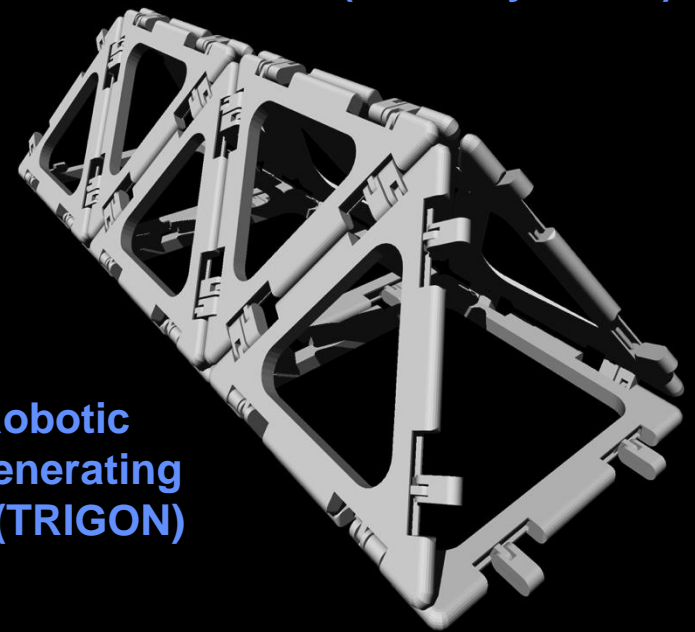

Class II Execution: Robotic Assembly



Credit: Scott Howe, JPL

Class III: In-situ Construction



- Need up-front technology
- Onsite effort
- Unlimited resources
- Sustainable

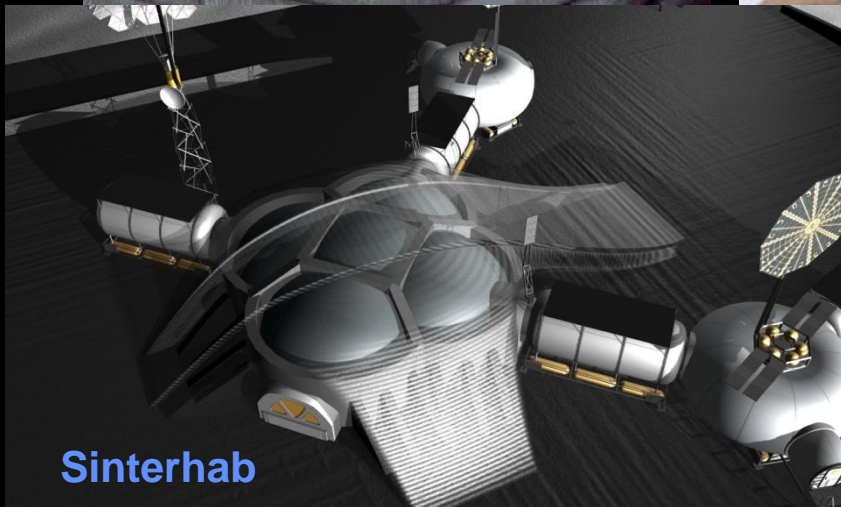
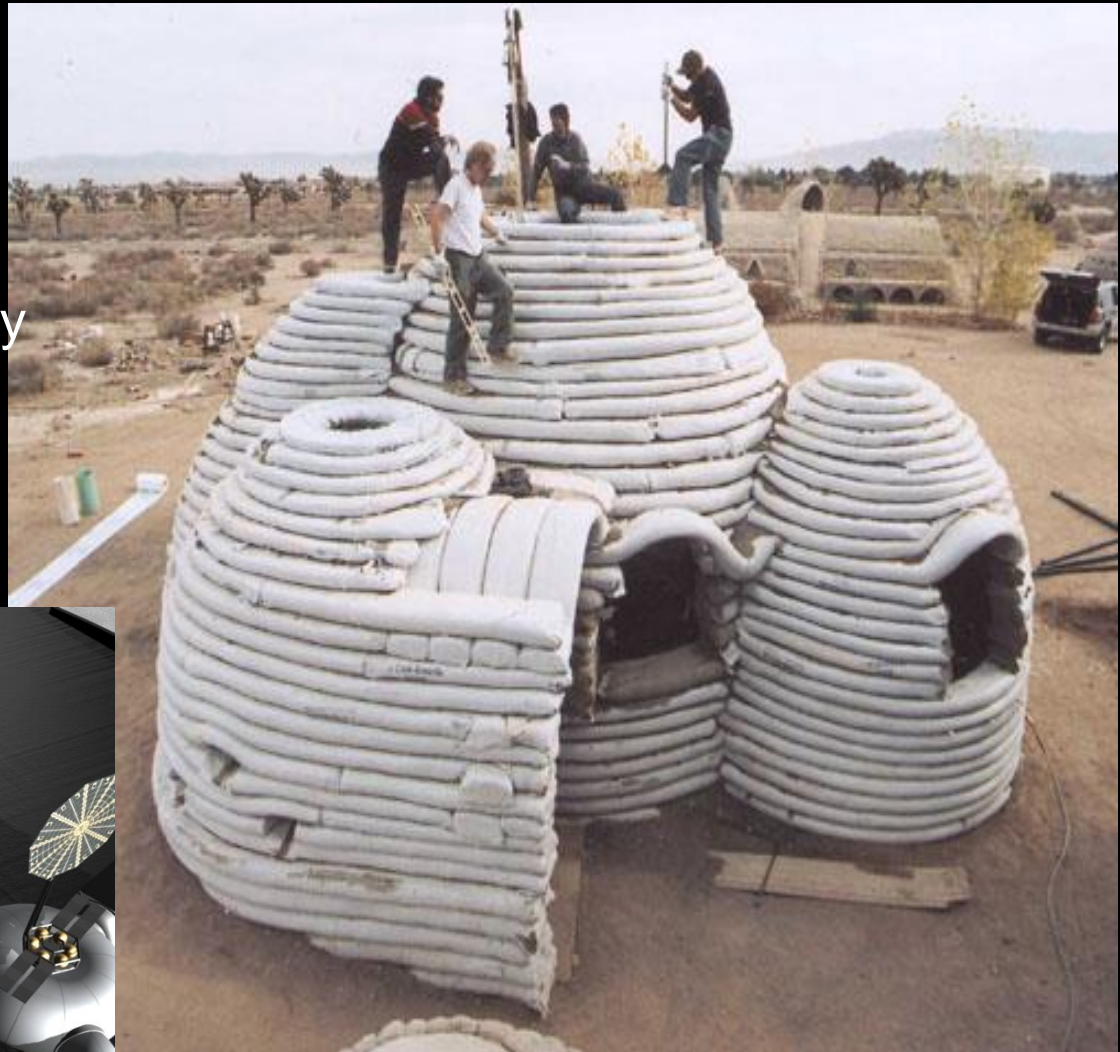

Sinterhab

Sandbag domes (courtesy CalEarth)

Class III Concepts: 3D Additive Construction

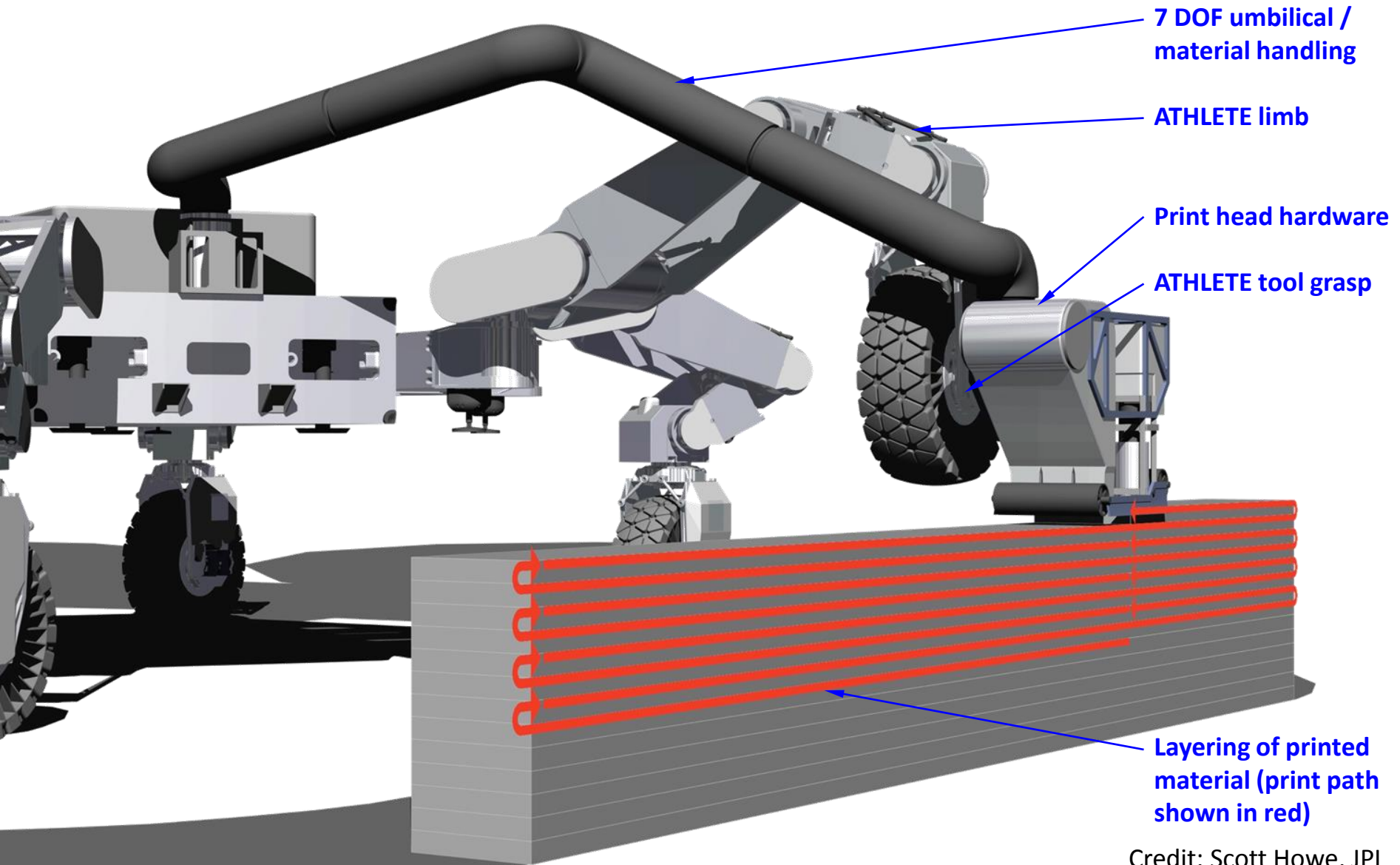

Credit: Scott Howe, JPL

Class III Concept: Shells Structures

1

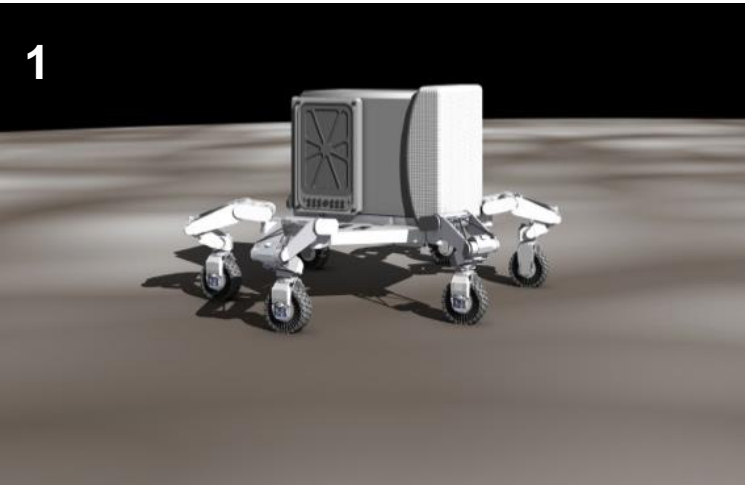

2

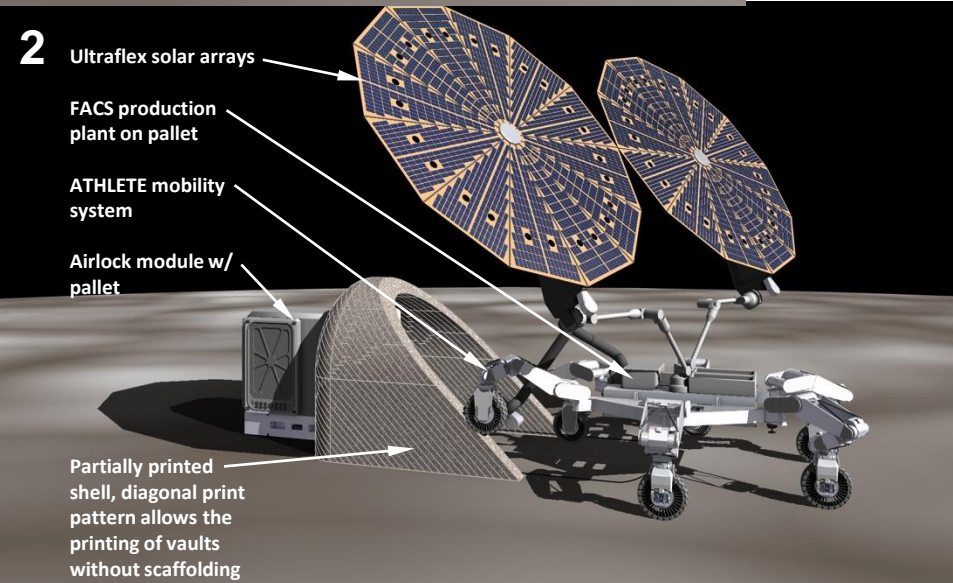

3

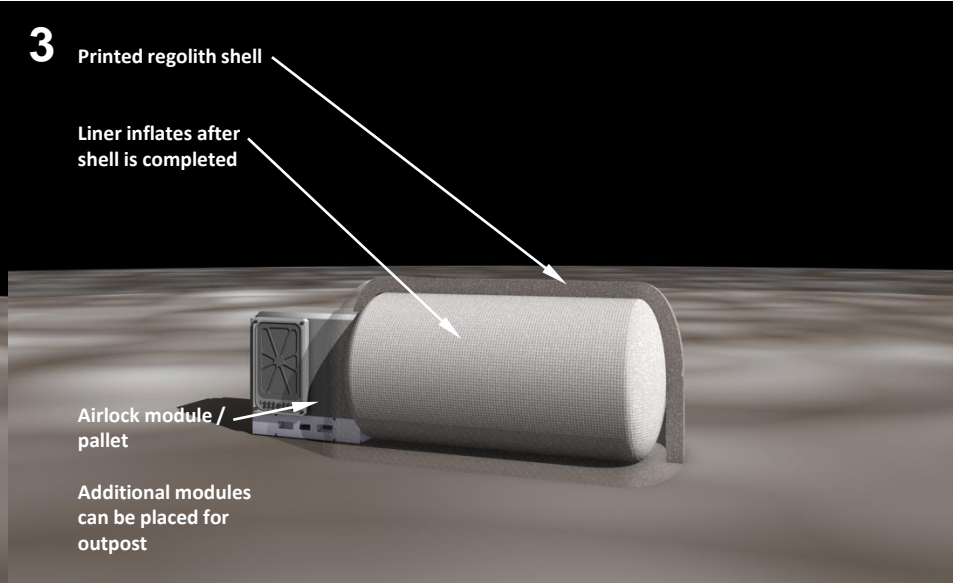

Application: Printed Habitat Shells: “Sinterhab”

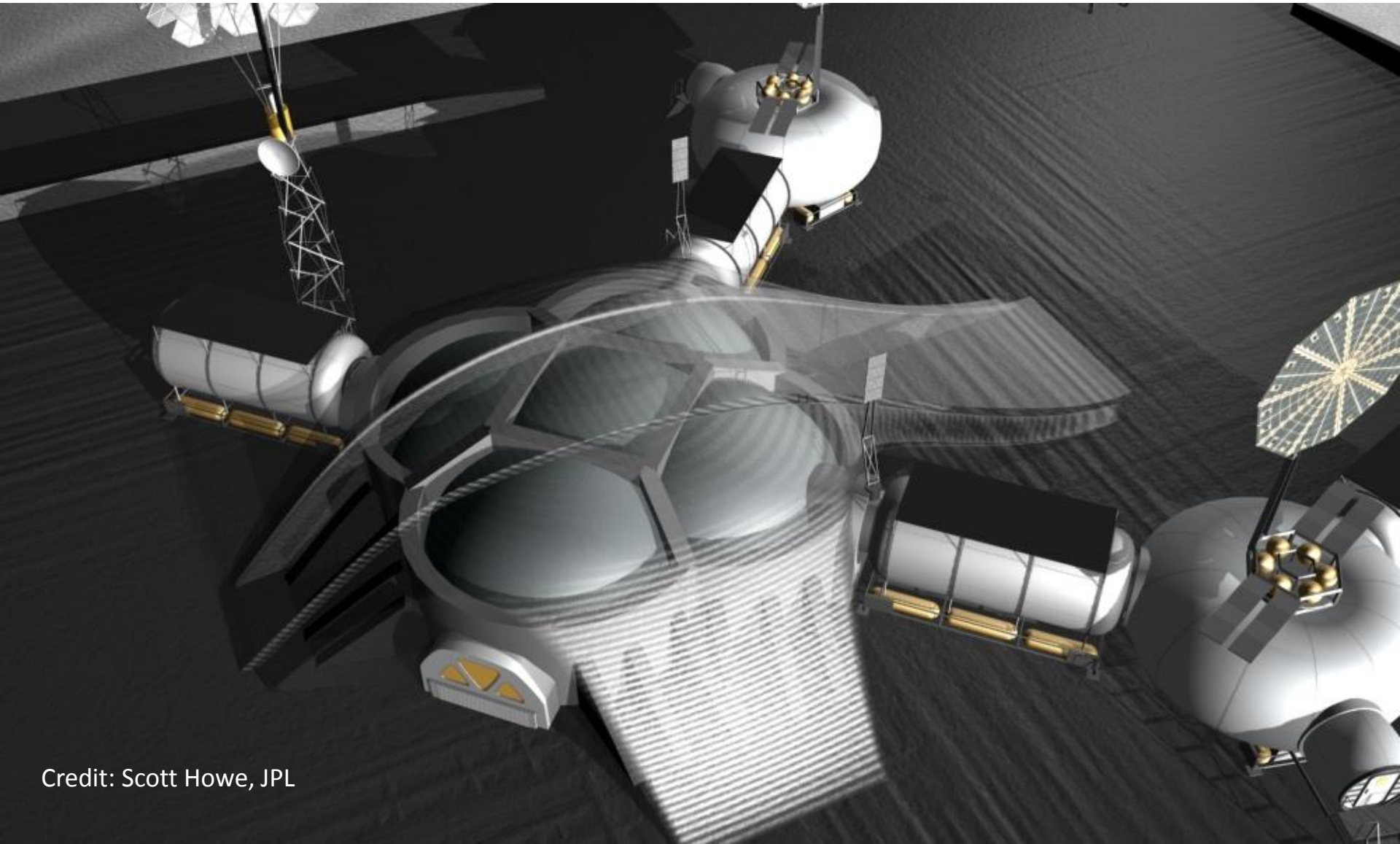

Credit: Scott Howe, JPL

Class III Concept: In-situ Assembly

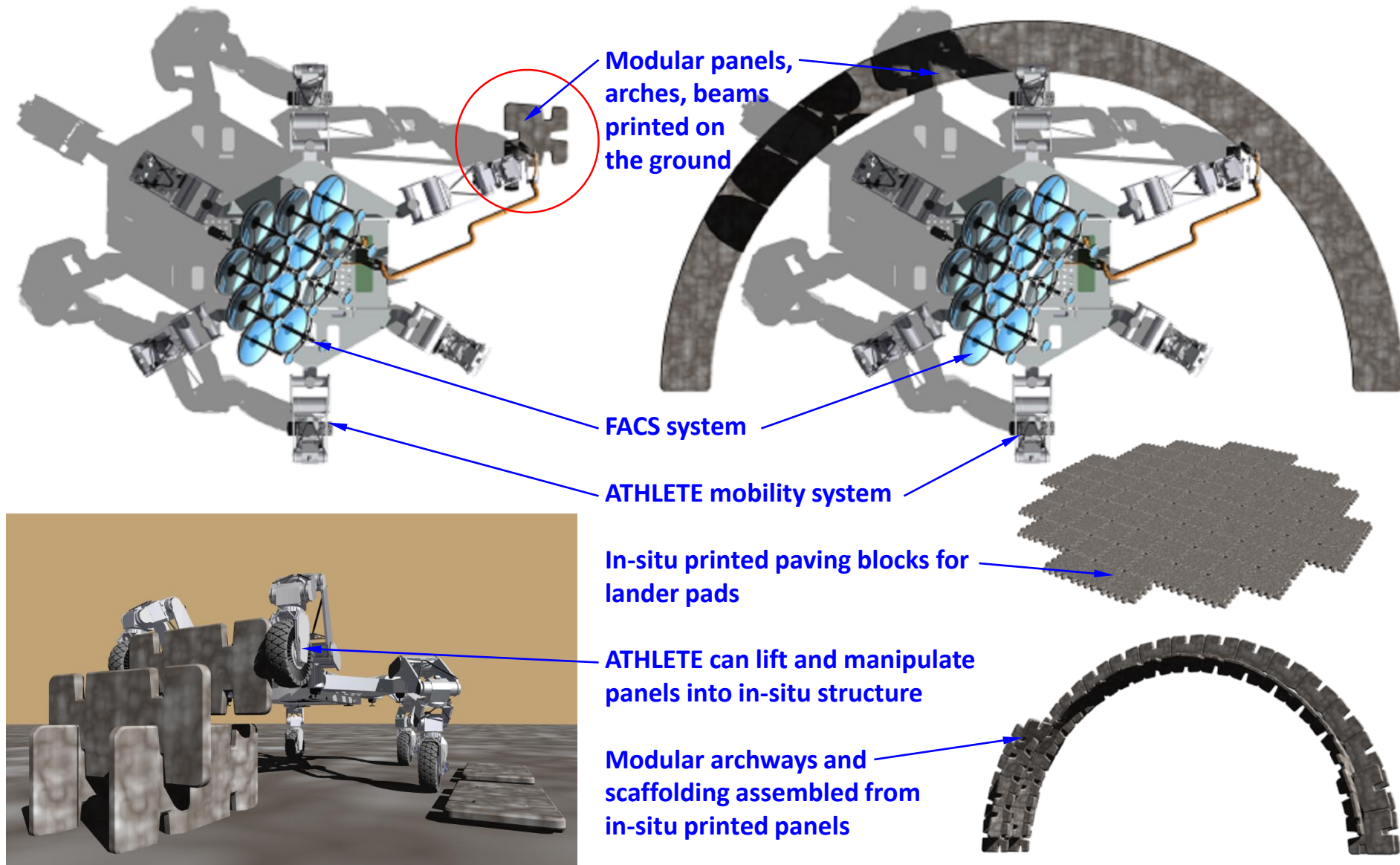

Class III Concept: In-situ Assembly

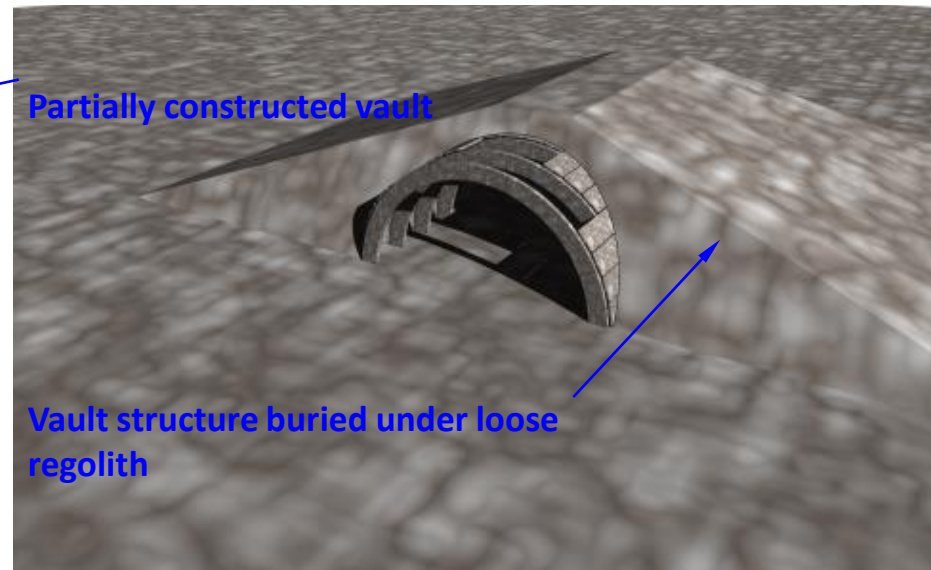
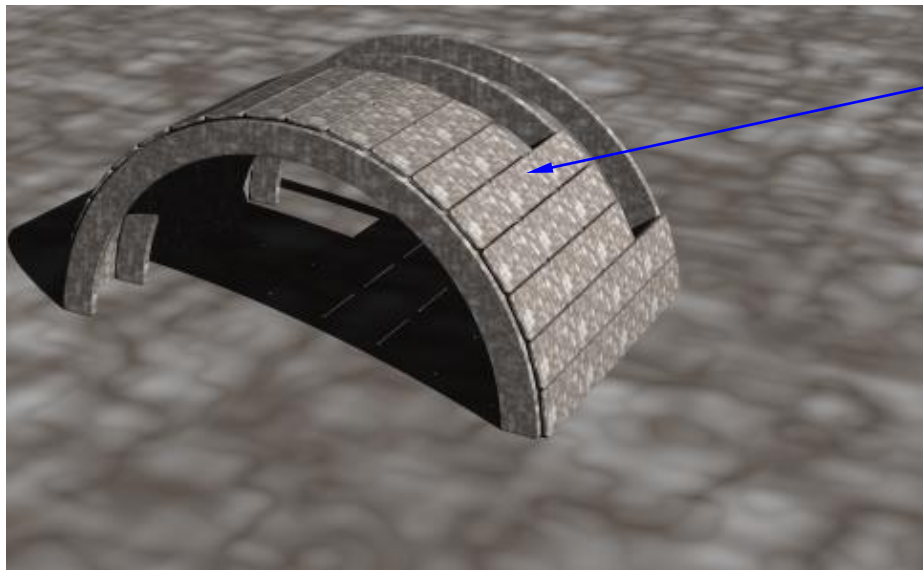
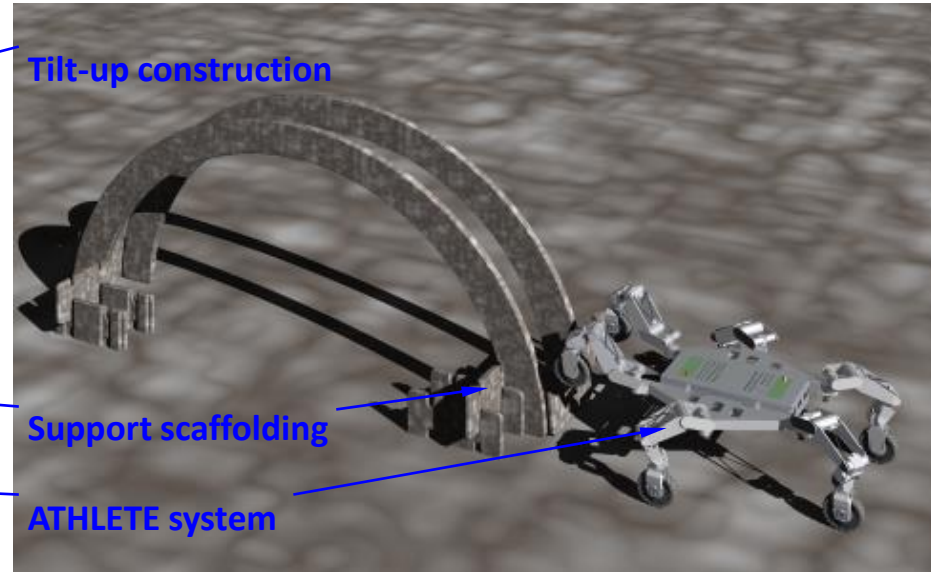
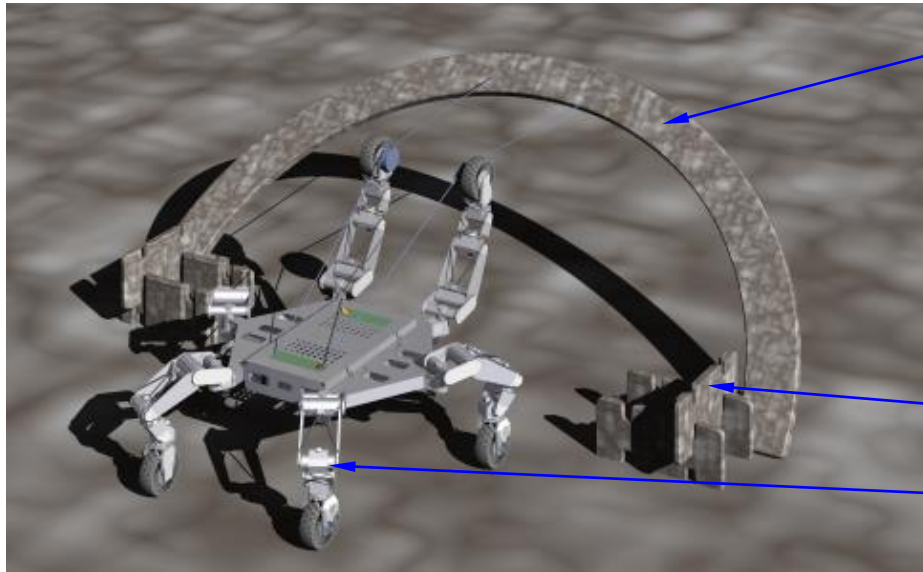

Asteroid Habitat Concept

- Microgravity Technology Demonstration: Stabilizing the surface of an asteroid that can be hollowed out for radiation protection of human habitats

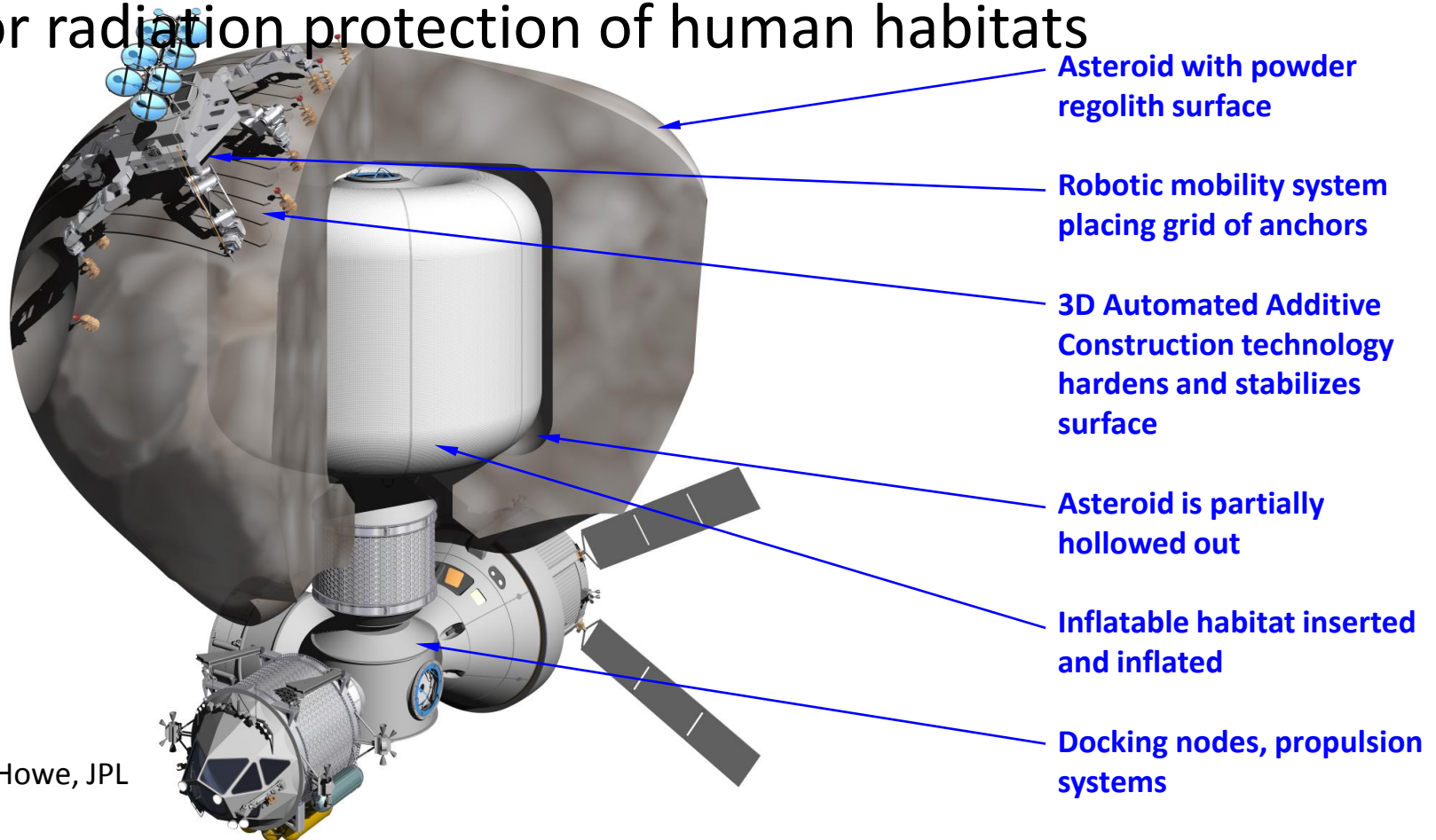

Vision for AAC

Time Frame (years)	Resource Utilization	Humans Off-planet	Automated Additive Construction Technology	Energy	Byproducts
10	Terrestrial demonstration of regolith processing / separation; Extraterrestrial prospecting	Trips to Moon / Mars / asteroids	Demonstrate terrestrial 3D printing with sintering / melting, print landing pads / shelters	All systems Earth manufactured	Volatile collection demonstration
25	Harness bulk regolith; Test regolith separation in space; Mars cyclers for radiation shielding	Habitation / outposts on Moon/Mars	Autonomous construction with bulk in-situ resources; 3D construction of landing pads, shelters in space	Exporting solar cells from Earth; manufacture concentrators in-situ	In-space collection of water separation into constituent gasses
50	Autonomous materials processing into desired elements / compounds; Cu/Fe extraction	Colonies; financially self-sustaining industries off-planet	Partial self-replicating factories; habitats/structures made in-situ	Sustainable off-world energy sources: solar concentrators, photovoltaics manufactured in-situ	Limited off-Earth fuel production: hydrocarbon, oxygen
100	Resource independence; terraforming asteroids; enclosed lunar / Martian cities	Communities on Mars / Moon / asteroids	3D additive industry; silicon / biologically based self-replicating factories	Communities independent of Earth resources; harness off-planet resources to create energy sources and storage	Sustainable off-Earth fuel production

Centennial Challenge: 3D Print a Habitat



PRIZES BY



CENTENNIAL
CHALLENGES

Challenge Sponsors:



3D
Printed
Habitat
CHALLENGE



Challenge Sponsors:



BRICK & MORTAR
VENTURES



Solving the need for safe, secure and sustainable housing on earth and beyond.

SPONSORED BY



America Makes AND Make:



NASA 3D Additive Construction 2015 Centennial Challenge – Top 3

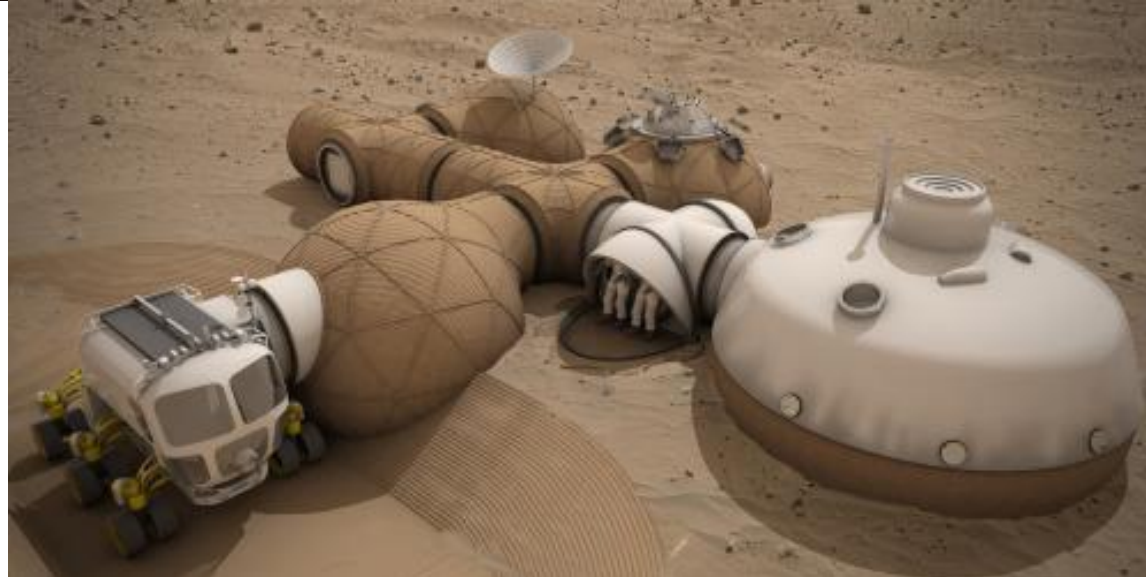
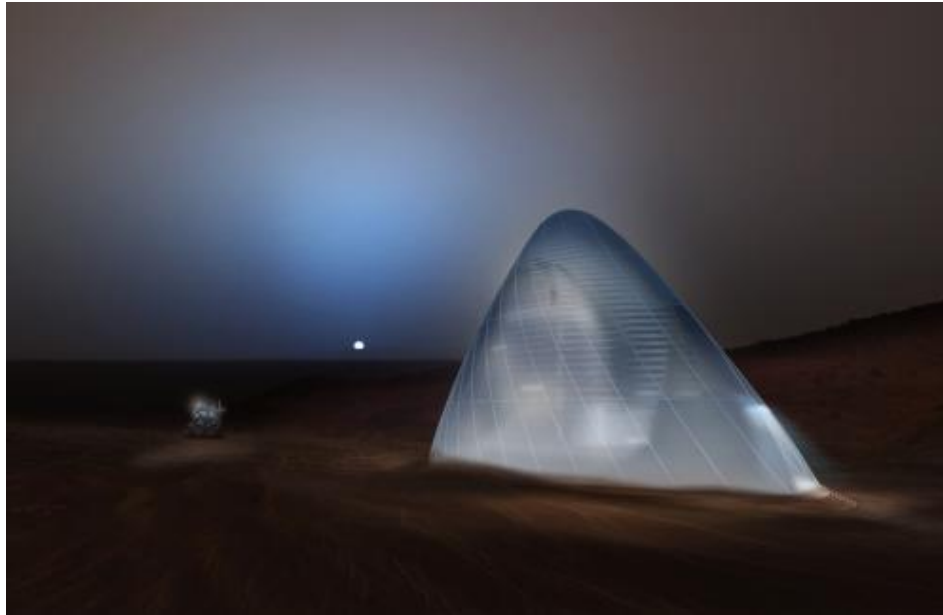
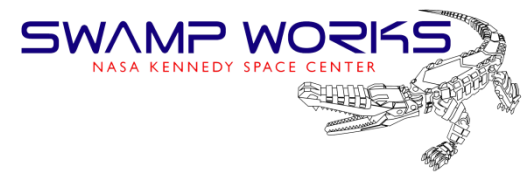

Summary

- There are vast amounts of resources in the solar system that will be useful to humans in space and possibly on Earth
- Shelter for fragile humans will be required
- Space faring humans will need planetary bases which will require planetary surface construction
- New technologies are developing rapidly, allowing for robotic automated construction
- Much more work is needed before Planetary Surface Construction becomes viable, but *the first commercial space companies are emerging today*
- Government labs are already developing prototypes
- *It's your future – make it happen*