

Advanced Wireless
Sensor Nodes -
MSFC 2016

Kosta
Varnavas -
Electronic
Design
Branch - ES
36

Jeff Richeson
- ES35
Contractor

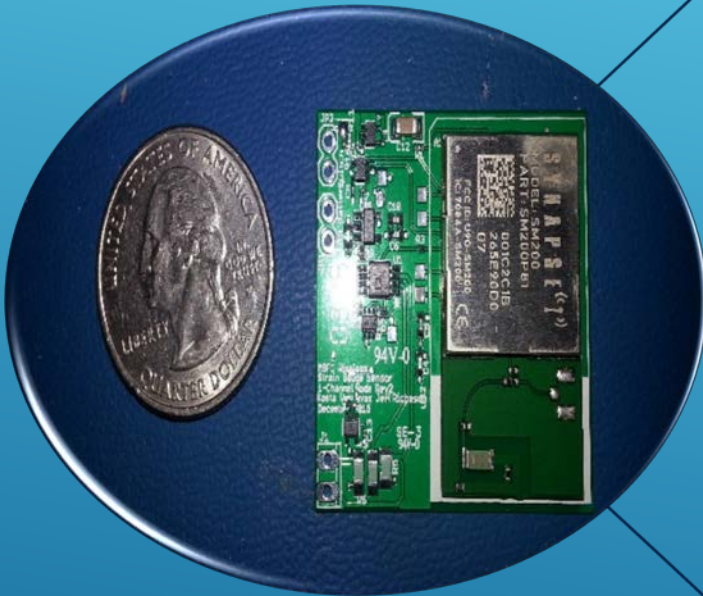

The Chosen ZigBee Module

RF200P81 / SM200
Synapse 2.4 GHZ IEEE
802.15.4/ZIGBEE® RF TRANSCEIVER

RX: 22.5 mA (@ 3.3 V)

TX: 22.5 mA (@ 3.3 V)

33.86mm x 33.86mm

20 GPIO and up to 7 A/D inputs

➤ The Synapse RF200 Modules, contain a complete A/D, Microcontroller ,802.15.4 radio and Mesh Protocol Software Stack.

➤ Capable of uploading new software into each module over the air (OTA).

SN132 SNAPstick USB module



SM200 Module Block Diagram

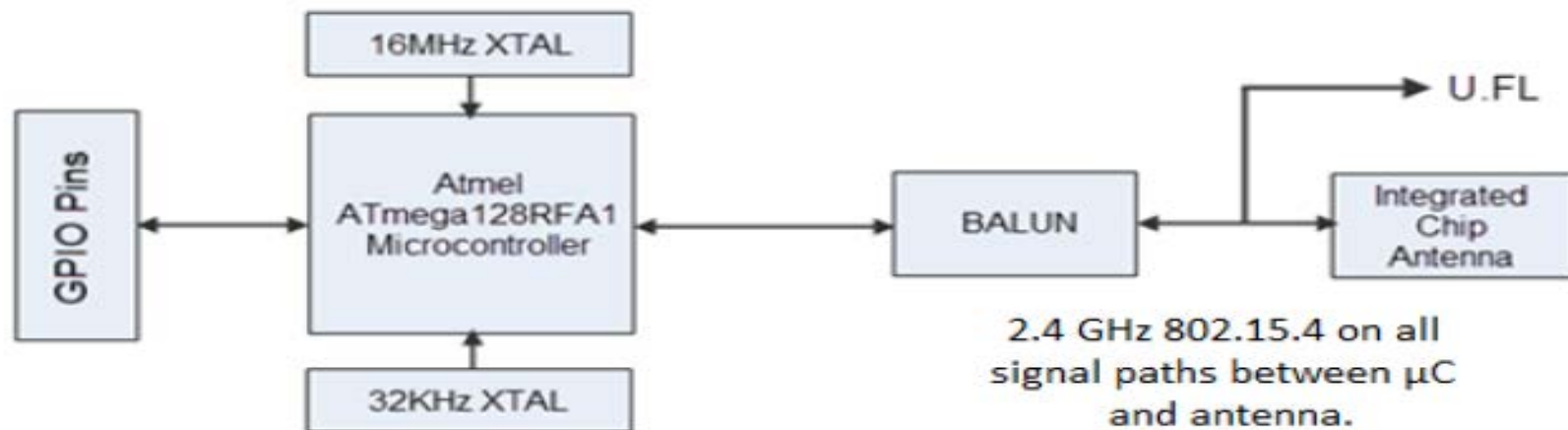
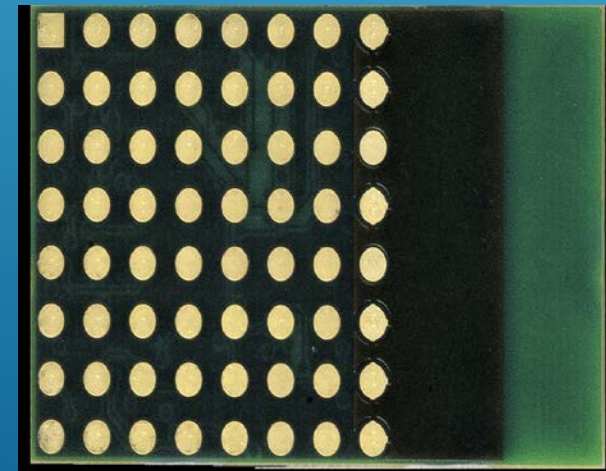
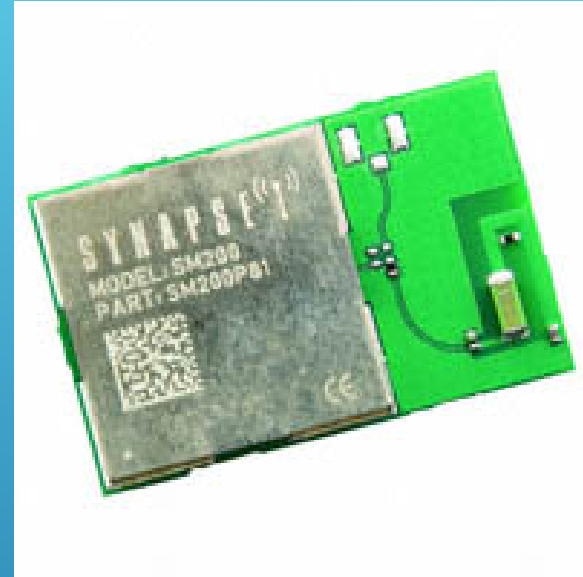

Table 1.0 Specifications

Table 1.0 Specifications		SM200P81/PU1	RF200P81/PU1
Performance	Outdoor LOS Range	Up to 1500/2500 feet at 250Kbps	
	Transmit Power Output	3 dBm	
	RF Data Rate	250Kbps, 500Kbps, 1Mbps, 2Mbps	
	Receiver Sensitivity	-100 dBm (1% PER, 250Kbps)	
Power Requirements	Supply Voltage	1.8 - 3.6 V	
	Transmit Current (Typ@3.3V)	22.5 mA	
	Idle/Receive Current (Typ@3.3V)	20.5 mA	
	Power-down Current (Typ@3.3V)	0.37 μ A	
General	Frequency	ISM 2.4 GHz	
	Spreading Method	Direct Sequence (DSSS)	
	Modulation	O-QPSK	
	Dimensions	29.8mm x 19mm	33.86mm x 33.86mm
	Operating Temperature	- 40 to 85 deg C.	
	Antenna Options	Integrated Chip Antenna / External Antenna	
Networking	Topology	SNAP	
	Error Handling	Retries and acknowledgement	
	Number of Channels	16	
Available I/O	UARTS with HW Flow Control	2 Ports - 8 total I/O	
	GPIO	38 total; 7 can be analog-in with 10bit ADC	20 total; 7 can be analog-in with 10bit ADC
Agency Approvals	FCC Part 15.249	FCC ID: U9O-SM200	FCC ID: U9O-SM200
	Industry Canada (IC)	IC: 7084A-SM200	IC: 7084A-SM200
	CE Certified	Yes	Yes

WIRELESS SYNAPSE FOOTPRINTS



Generation 1

"Gen 1"

6 gauges all powered at same time.

Strain gauged excitation voltage is straight off main battery rail.

Op amp only has a 200 gain. This is a fixed gain set by on board resistor

No shunt or other method for onboard calibration.

No Power Management



Generation 2

Only 1 Gauge

- Another version coming with 3 gauges for 3-dimensional measurements

Each strain gauge has an independent constant voltage regulator driving the excitation voltage

- This provides solid voltages for more accurate measurements.

Power Management Hardware

- The power for each gauge sub circuit can be turned on or off by software saving battery power.

Op Amp has much larger and adjustable gains

- Gains up to 1000 and is variable under
- software control via digital potentiometer.

Power Management Software

- Software can control power management
- hardware to maximize battery life.





Gen 2 Wireless Strain Gauge

- * 1 Channel
- * With Battery
- * 1.5 " x 1.3 " without case.

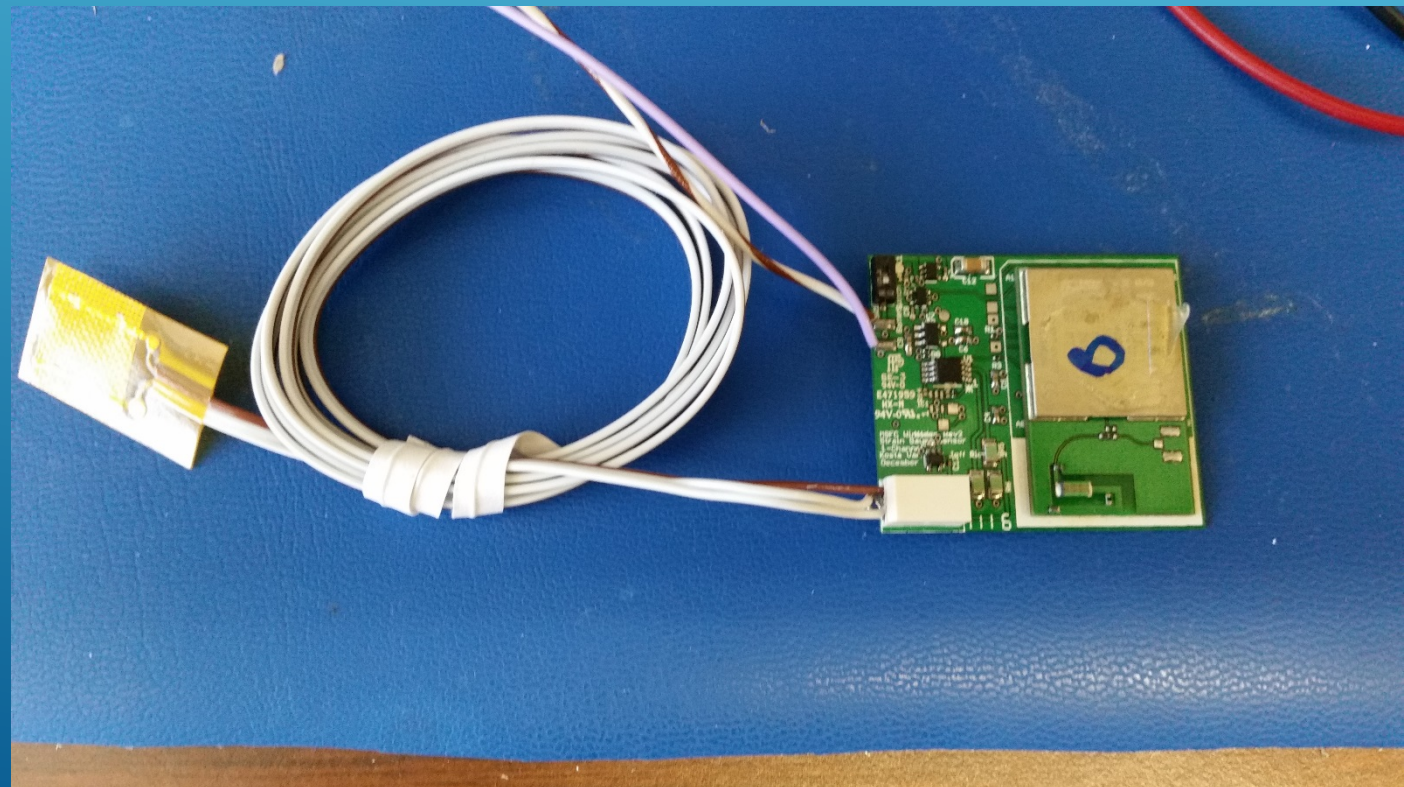

Gen 2 Wireless Strain Gauge with power leads And strain gauge Attached.

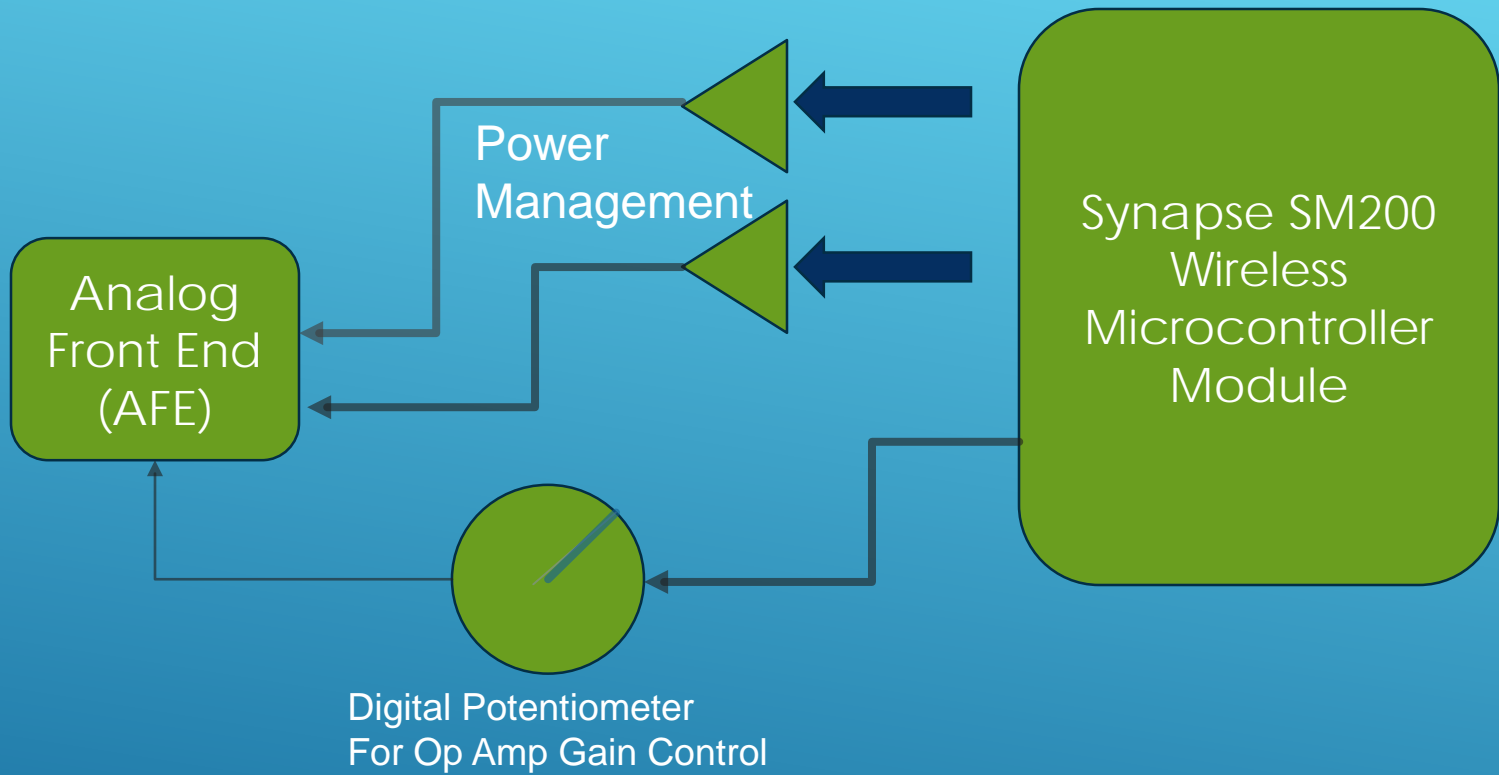

BLOCK DIAGRAM WIRELESS STRAIN GAUGE

MCP40D17 Digital Potentiometer Range Controlled by Wireless Strain Gauge Rev2 Board

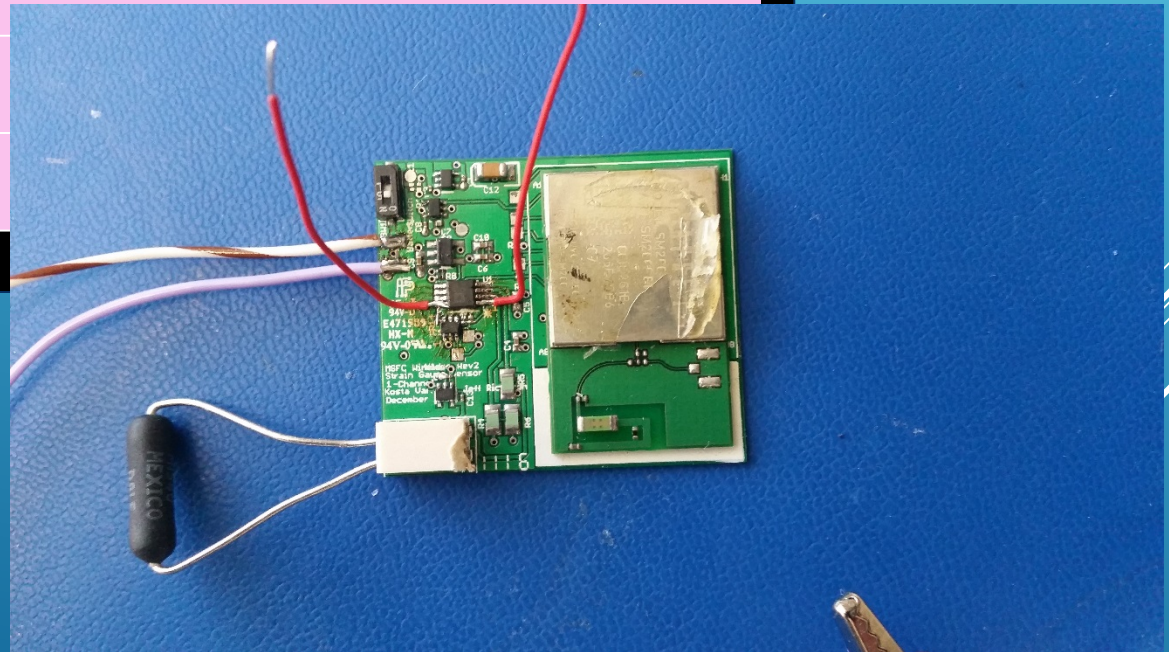
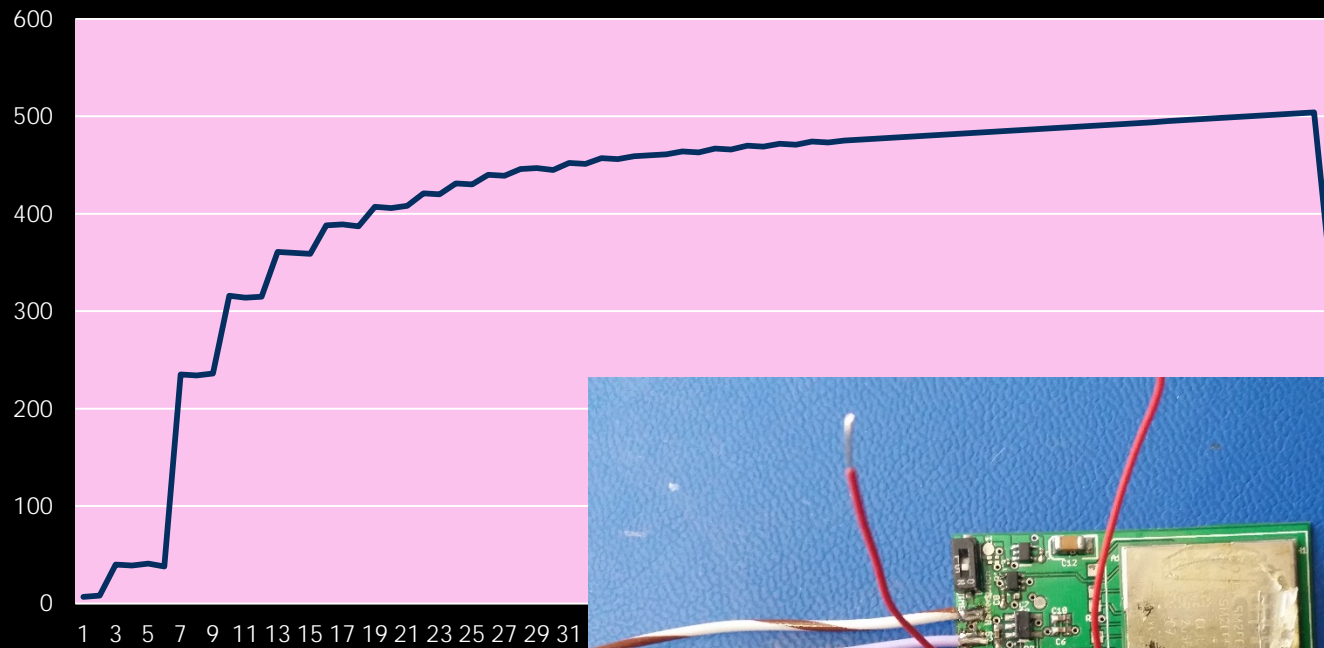

Test of op amp gain change
using digital potentiometer
and 350 ohm reference
resistor.

Wireless Temp Board

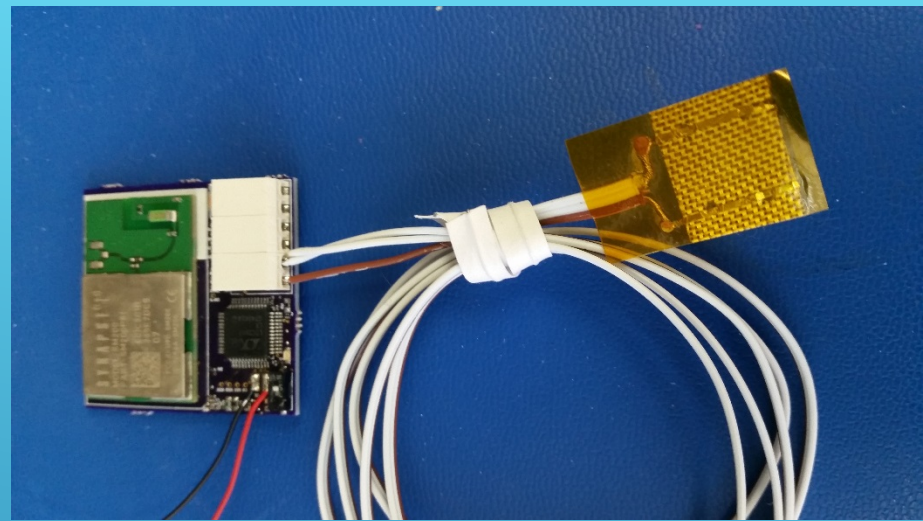

With
RTD

Can measure :

- virtually all standard (type B, E, J, K, N, S, R, T) or custom thermocouples.
- Automatically compensate for cold junction temperatures and linearize the results.
- 2-, 3-, or 4-wire RTDs.
- Thermistors.
- Diodes.
- SPI bus controlled.

3-D printed (additive manufactured) casing for the 5-bay charging system was designed and created. Same as the blue housing for sensor node.

This is one wireless module on charging circuit. Charging bay has room for 5 modules.

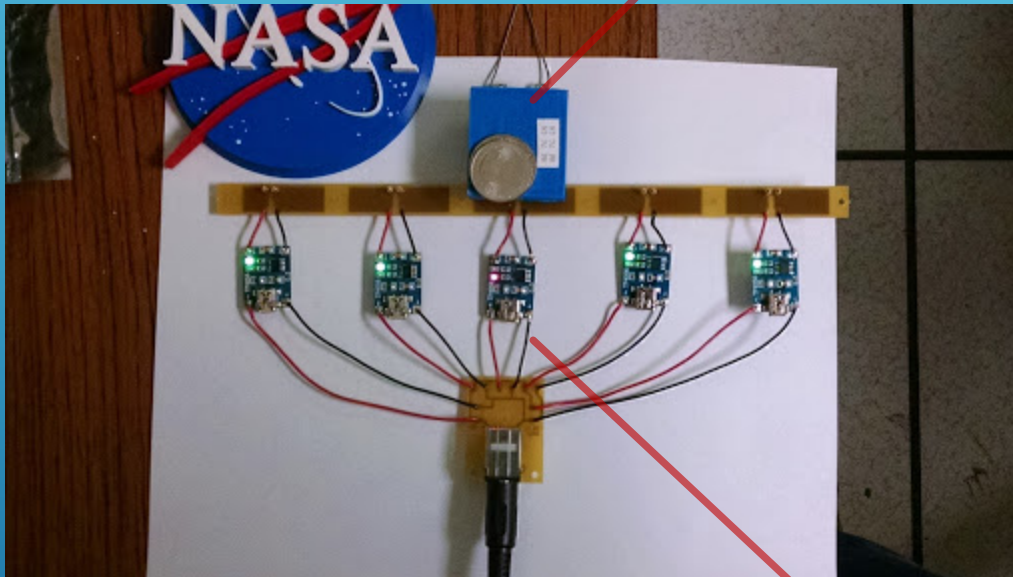

Commercial charging nodes , are specific for charging and preventing over charging of Li-ion batteries.



20 – 1 Channel MSFC Wireless Sensor inside
Composite shell

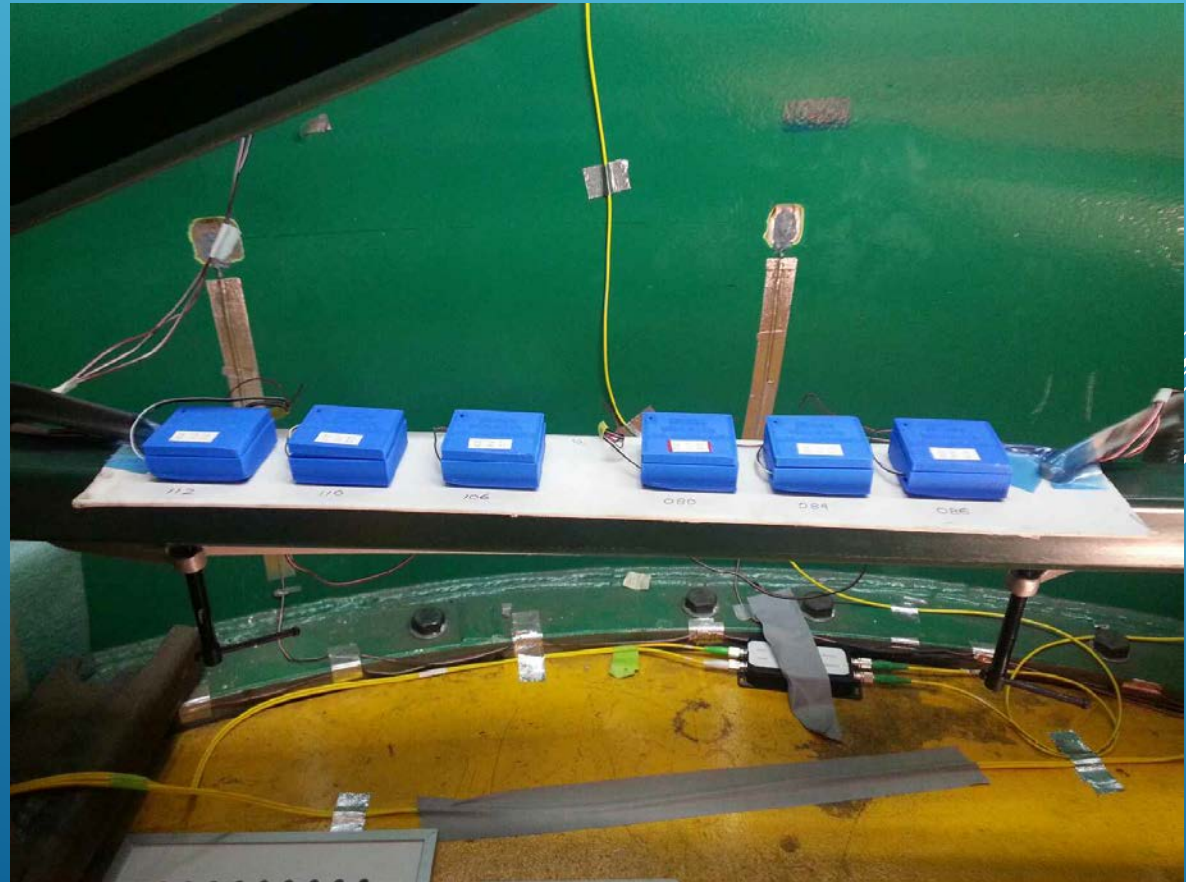

Composite Shell Buckling Test

Synapse Portal: default.swn - Workspace C:\Users\kvarnava\Documents\Portal

File View Options Network Help

Node Views x Master_Node_Logger.py BridgeNodeBroadcaster.py BridgeNode1.py

Active Nodes 23 nodes

Node	Network Address	Device Image	Link Quality	Device Type
Portal	00.00.01	Master_Node_Logg...		Portal
Bridge	5C.DB.98	BridgeNodeBroadc...	68%	None
Node19	5E.79.A9	MSFC_Strain_1-Cha...	79%	None
Node14	5E.79.C3	MSFC_Strain_1-Cha...	6%	None
Node10	5E.79.FA	MSFC_Strain_1-Cha...	76%	None
Node20	5E.79.FE	MSFC_Strain_1-Cha...	76%	None
Node18	5E.7A.33	MSFC_Strain_1-Cha...	76%	None
Node8	5E.7A.47	MSFC_Strain_1-Cha...	71%	None
Node5	5E.7A.5A	MSFC_Strain_1-Cha...	6%	None
Node7	5E.7A.5B	MSFC_Strain_1-Cha...	75%	None
Node16	5E.7A.94	MSFC_Strain_1-Cha...	80%	None
Node4	5E.7B.00	MSFC_Strain_1-Cha...	72%	None
Node3	5E.7C.A4	MSFC_Strain_1-Cha...	58%	None
Node11	5E.7C.C5	MSFC_Strain_1-Cha...	6%	None
Node15	5E.7C.CA	MSFC_Strain_1-Cha...	67%	None
Node23	5E.7C.D3	MSFC_Strain_1-Cha...	74%	None
Node22	5E.7C.D5	MSFC_Strain_1-Cha...	67%	None
Node	5E.7D.11	MSFC_Strain_1-Cha...	70%	None
Node6	5E.7D.6C	MSFC_Strain_1-Cha...	74%	None
Node21	5E.7D.96	MSFC_Strain_1-Cha...	71%	None
Node9	5E.7D.9C	MSFC_Strain_1-Cha...	6%	None
Node17	5E.7D.B5	MSFC_Strain_1-Cha...	68%	None
Node12	5E.7D.B6	MSFC_Strain_1-Cha...	68%	None

Node Info

Bridge

Firmware Version: 2.4.22 with AES-128 (Out of Date)

Platform: RF200

Network Address: 5C.DB.98

MAC Address: 00:1C:2C:1B:26:5C:DB:98

Device Image: [BridgeNodeBroadcaster](#)

Image CRC: 0xE800

Image Size: 1914 bytes (3%)

License: Permanent

Channel: 4

Network ID: 0x1C2C

Path

No path information collected

Info

In your Portal script, use `remoteNode.setColumn(name, value)` to display information here

SNAPpy Modules

- BridgeNodeBroadcaster
 - [broadcastValue\(val\)](#)
 - [EnableBroadcast\(En\)](#)
 - [startupEvent\(\) <-- Startup timerEvent\(\) <-- 1s Timer](#)
- BuiltIn
 - [pinWakeUpATmega128RFAL](#)

Event Log

Time	Event	Device	Type	Value
2016-05-12 14:43:36	QUERY	Node19	Network ID	0x1C2C
2016-05-12 14:43:36	INV PARAM	Node19	MAC Address	00:1C:2C:1B:26:5E:79:A9
2016-05-12 14:43:36	QUERY	Node19	SNAPpy Spac	59903
2016-05-12 14:43:36	INV PARAM	Node19	Device Type	None

Ready

www.synapse-wireless.com

RPCs in Queue: 0

Connected: USB0 [38400]

Control GUI – Large amount of interference caused all of the nodes to drop out shortly after test began. The test article was in a safety keep out zone so there was no way to fix or restart with fewer nodes after testing started.

Test Lab Pull Test July 2016 Setup

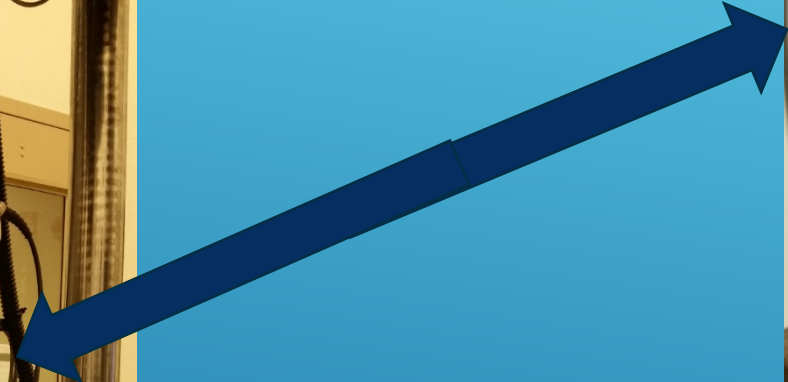
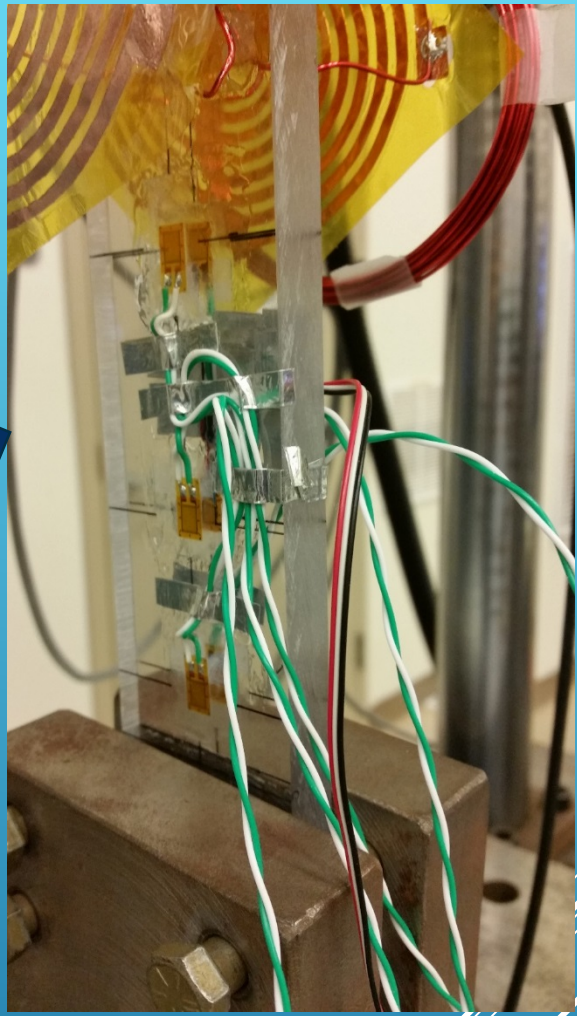
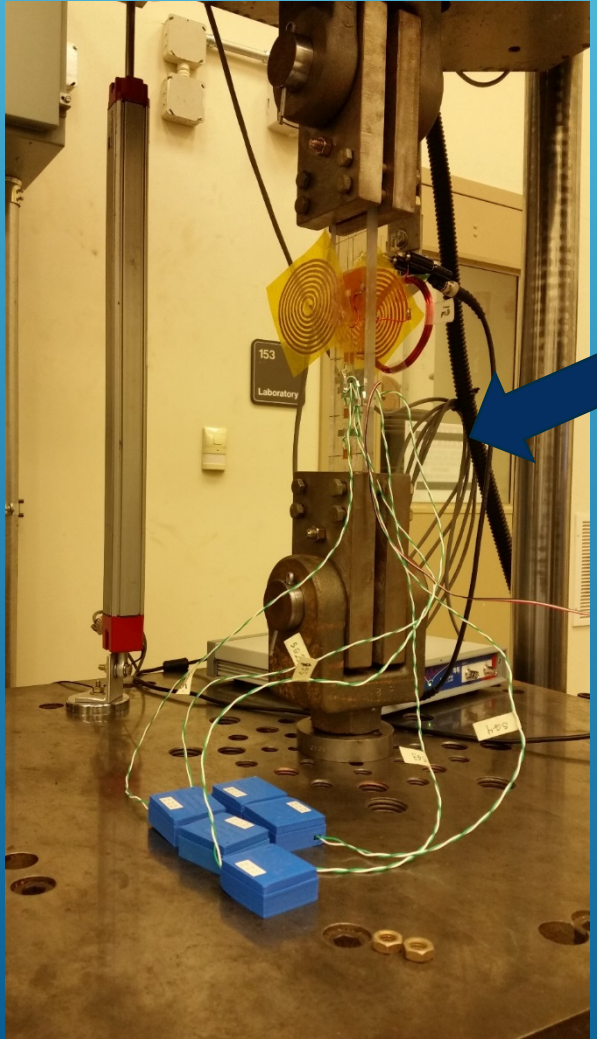

Test Lab Pull Test July 2016 Data Results

5e7b00	26175 packets
5e7ca4	79348 packets
5e7a5a	24553 packets
5e7cc5	26585 packets
5e7a47	24692 packets

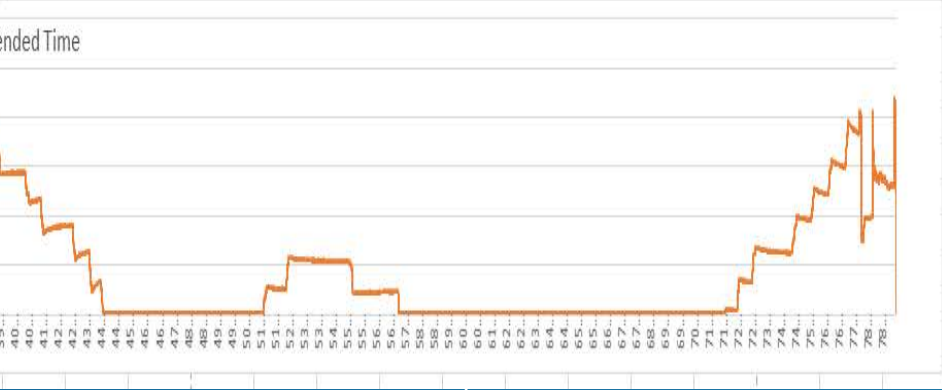
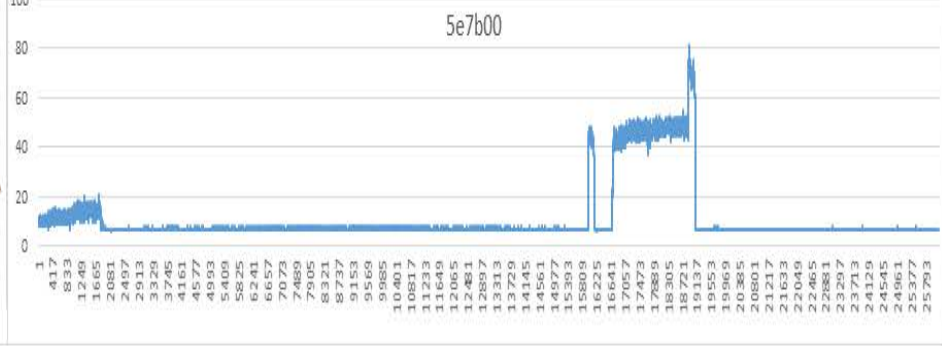
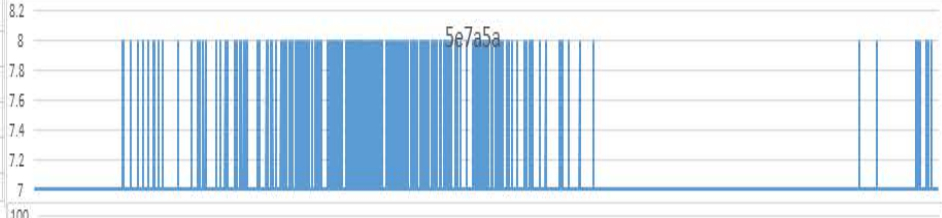
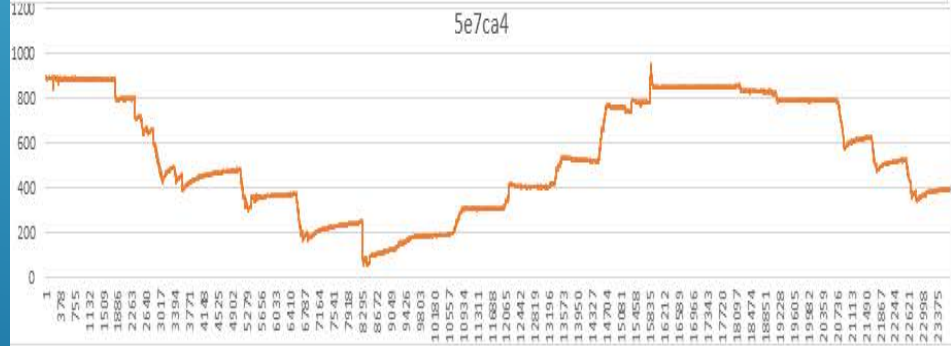
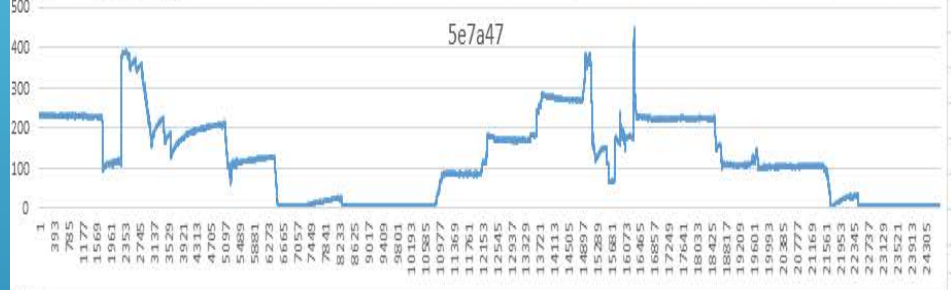

Coming
In Gen 3



Better
Battery and
Power
Managem
ent

Calibration
shunt that can
be switched in
and out of
circuit by
software.



Advanced
Software
Controls

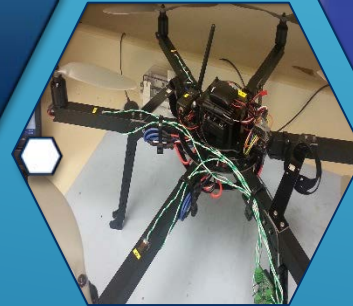

- ▶ Kosta Varnavas ES36

- ▶ kosta.varnavas@nasa.gov

- ▶ 256-544-2638

- ▶ Jeff Richeson ES35

- ▶ James.j.richeson@nasa.gov

- ▶ 256-961-0128

Back Up Charts

