

# ADVANCED DEPLOYABLE STRUCTURAL SYSTEMS FOR SMALL SATELLITES

**W. Keith Belvin<sup>1</sup>, Marco Straubel<sup>2</sup>, W. Keats Wilkie<sup>1</sup>, Martin E. Zander<sup>3</sup>, Juan M. Fernandez<sup>1</sup>, and Martin F. Hillebrandt<sup>2</sup>**

*<sup>(1)</sup> NASA Langley Research Center, Hampton, VA, USA*

*<sup>(2)</sup> DLR Institute of Composite Structures and Adaptive Systems, Braunschweig, GERMANY*

*<sup>(3)</sup> Institute of Adaptronics and Function Integration, Technische Universität Braunschweig, GERMANY*

## ABSTRACT

One of the key challenges for small satellites is packaging and reliable deployment of structural booms and arrays used for power, communication, and scientific instruments. The lack of reliable and efficient boom and membrane deployment concepts for small satellites is addressed in this work through a collaborative project between NASA and DLR. The paper provides a state of the art overview on existing spacecraft deployable appendages, the special requirements for small satellites, and initial concepts for deployable booms and arrays needed for various small satellite applications. The goal is to enhance deployable boom predictability and ground testability, develop designs that are tolerant of manufacturing imperfections, and incorporate simple and reliable deployment systems.

## 1. INTRODUCTION

Over the past decade, the size of spacecraft components and subsystems has been significantly reduced. As a result, small satellites of the future may provide comparable or even better performance than much larger satellites of the past. To increase the functionality of small satellites, novel methods for packaging and deployment of structural booms and arrays are needed.

State of the art spacecraft boom concepts are mainly designed for large satellites with large appendages. Scaling existing boom designs for small satellite applications leads to manufacturing issues due to limited packaging volume. Currently, there is a lack of reliable and efficient boom and membrane deployment concepts for small satellites. In particular, booms with high structural performance and reliable deployment in the 5-20 meter length class are not available.

To develop small satellite boom and array concepts, NASA and DLR began a joint project in 2016 to develop advanced deployable structural systems for small satellites. The project focuses on deployable booms and deployment mechanisms for small satellite applications such as solar arrays, solar sails, drag sails and instrument booms.

The paper provides a state of the art overview on existing spacecraft deployable appendages, the special requirements for small satellites, and initial concepts for deployable booms and arrays needed for various small satellite applications. The goal is to enhance deployable boom predictability and ground testability, develop designs that are tolerant of manufacturing imperfections, and incorporate simple and reliable deployment systems.

## 2. SPACE APPLICATIONS

Due to the miniaturization of spacecraft avionics, small satellites can now provide many of the services that larger satellites performed in the past. Consequently, mission applications previously achievable only by large satellites became target applications for small satellites. While the avionics and instruments have decreased in size, some satellite components that require collecting or reflecting photons and electromagnetic (EM) radiation must necessarily remain large, for example, photovoltaic power arrays, communication antennas, and solar sails. Thus small satellites need booms and arrays that package in small volumes and miniaturized deployment sub-systems to enable system engineers to design more functional small satellites.

This section describes some applications for deployable booms. A key observation is that *the dimensions of deployable structures are not necessarily scaling with the dimensions of their host satellites!* Thus large (5-20 m) lightweight deployable booms are critically needed for small satellites. These booms must not only provide stiffness and thermal stability, they must also be reliably deployed after being stowed for many years.

### 2.1 Solar Arrays

Solar Arrays generate the power to run all electric subsystems of the hosting satellite. The power generated depends on the efficiency of the photovoltaic cells and the total array area. Consequently, the size of the array depends on the power demand of the hosting satellite, which will vary with different missions and not necessarily with the satellite size.

Classical solar arrays are based on hinged panels for “accordion type” deployment. Small spacecraft require lighter arrays with higher packaging efficiency. Thus flexible substrates and deployable booms are being used to lightweight solar arrays for small spacecraft.

### 2.2 Communication antennas

Communication antennas are used to communicate with Earth ground stations or with other satellites. For communication with high data rates and low power consumption large reflectors are needed. High data communication antennas are usually realized by parabolic reflector antennas (see Fig. 1) and in some cases by flat array antennas (see Fig. 2).



Fig. 1. Photo of the SRAL EM parabolic radar antenna of the European Sentinel 3 satellite (image credit: TAS, ESA)



Fig. 2. Canadian RadarSat2 with two symmetric solar arrays (deployed sideways) and one large deployed radar array antenna (downward facing), (image credit: CSA)

Phased array antennas steer the beam electronically by defining dedicated phase shifts for each array element. It is thereby able to point the antenna on a target without a physically reorientation of the antenna structure. Hence, these antennas do not require a mechanical steering mechanism.

The dimension of the antenna and the required surface accuracy are thereby related to the frequency band. Higher frequencies result in shorter wavelength and therefore in smaller antenna dimensions but high frequency antennas require higher surface accuracy.

### **2.3 Radar antennas**

Radar antennas are in general very similar to communication antennas. The significant difference is the usage of this antenna. Radar antennas are usually scanning the ground below or adjacent to the ground path. Therefore, the antenna does not require pointing to one spot (like a ground station) and can be attached directly to the satellite structure without steering mechanisms. The required size of the antenna depends on the frequency band (higher frequencies allow smaller antennas) but also on the achieved resolution of the acquired images (finer resolution requires larger antennas).

### **2.4 Drag sails**

Drag sails (see Fig. 3) are passive deorbiting devices which use huge deployable surfaces that use the very thin residual atmosphere in low earth orbit (LEO) to decelerate a satellite after it has finished its mission. Due to the constant deceleration, the orbit of the satellite is lowered followed by dense atmosphere re-entry and burn-up.

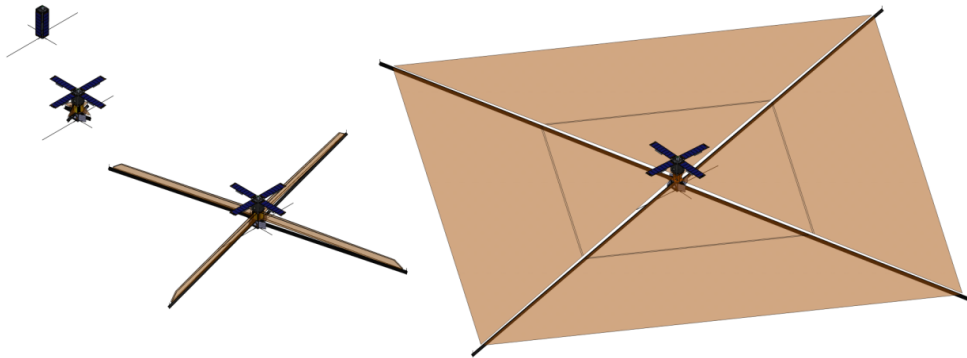

Fig. 3. Deployment sequence of Deorbit Sail CubeSat, launched 2015, deployment motor failure (project under lead of University of Surrey, GB. Booms and boom deployer by DLR)

The drag sail is deployed after the primary mission is completed (~10-15 years), which results in a very long stowed lifetime of the drag sail. This results in challenges for materials selection and mechanisms design and qualification.

### **2.5 Solar sails**

Solar Sails are propellantless propulsion systems as shown in Fig. 4 that generate thrust by reflecting solar photons. Therefore, they require large but very light reflective surfaces that are usually provided by very thin metallic coated membranes. Every square meter of sail area

increases the solar pressure induced force and every additional kilogram limits the acceleration that results from this force. Hence, extreme lightweight design is crucial for solar sails. The loads on solar sails during mission are limited to solar pressure, maneuver and thermal loads.

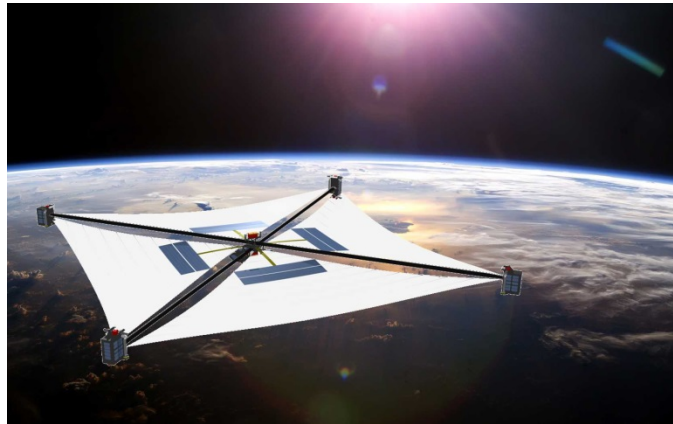

Fig. 4. GOSSAMER-1 Solar Sail developed by DLR

### 2.6 Instrument booms

Instrument booms are used to deploy sensors from a satellite in order to limit the influence of the inherent satellite magnetic field on the sensor data (see Fig. 5). Another application is a boom that elevates the position of a lander camera to oversee its landing site or the operation area of a rover (like in Fig. 6.). Such booms can also be used to offset a camera from a host satellite to allow the supervision of more complex deployment operations.

Instrument booms support a single tip mass during deployment and in the deployed state. Primary design drivers are maneuver and thermal loads (in-space) and in the case of surface systems, gravity loads as well.

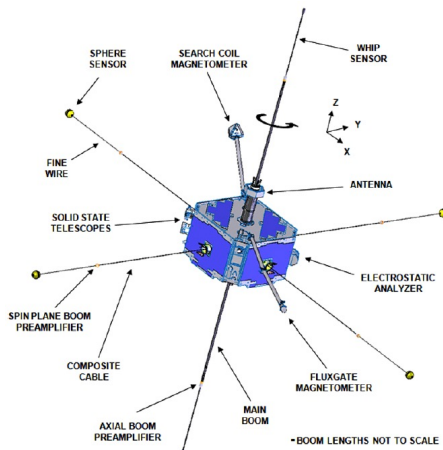

Fig. 5. THEMIS satellite with deployed booms (image credit: Univ. of California, Berkeley, USA) (Auslander, et al., 2008)



Fig. 6. Deployable stereo camera systems of Phoenix mars lander, (image credit: Lockheed Martin)

### 3. DEPLOYABLE BOOMS STATE OF THE ART

Deployable mast concepts considered here are scalable to specific masses lower than 0.5 kg/m and have a bending stiffness  $EI$  greater than 1500 Nm<sup>2</sup>. These values are chosen to comply with the needs of lightweight structures and to narrow the considered booms concepts to a reasonable number. The following overview is just a brief introduction into deployable space booms. More detailed descriptions can be found in [1], [2] and [3].

#### 3.1 Storable Extendible Tubular Member (STEM) booms

Astro Aerospace's Storable Extendible Tubular Member (STEM) is a deployable structure that has flown since the 60's. The STEM is piece of steel or other material that rolls up flat on a drum and that returns to its circular shape on deployment via motor command. It is capable of pushing or pulling and is useful as a deployment structure for other booms. The stowed STEM fits into a small space and can extend many times its stowed length.

A derivative is called the BI-STEM [4], which can also be used as a deployable and retractable telescoping mast. The B-STEM has very high accurate positioning characteristics. A telescoping mast can employ a Bi-STEM (a two-piece STEM) boom as an actuator and stabilizer, which alleviates the need for the deployed telescoping mast segments to overlap. Due to this feature and because the segments can be fully overlapped when stowed, the mast enables an unusually lightweight and compact launch configuration.

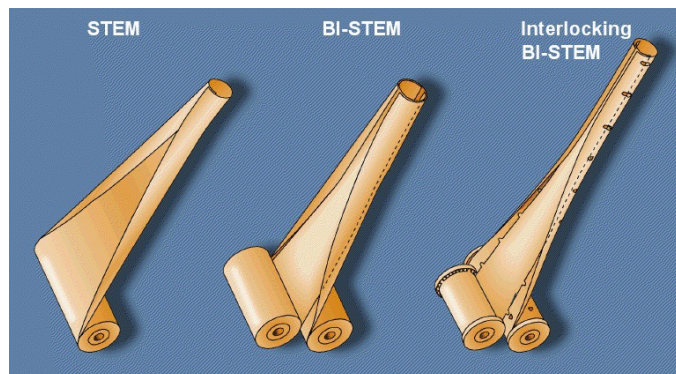

Fig. 7: Variations of the STEM boom concept [Source: NASA]

#### 3.2 Collapsible Tube Mast (CTM) booms

Sener developed the collapsible tube mast (CTM) [5] which is a boom originally made of a Beryllium Copper alloy that can be rolled and deployed from a canister as shown in Fig. 8. It consists of two thin flexible shells with a biconvex shape bonded at their edges by resistance seam welding. The boom can be flattened and coiled up on a cylindrical core which enables very long masts to be stowed within a very small volume because it is almost independent from the mast's length [6].

Beginning in 1998, DLR developed different versions of carbon fiber reinforced polymer (CFRP) CTMs of different scales and for various applications (see Fig. 9). In preparation for a 20m X 20M solar sail mission called Gossamer-2, DLR designed and built 14 m CFRP booms and tested them in simulated space and launch environments. Composite laminate CTM booms are the leading boom concept for the collaborative NASA/DLR project.

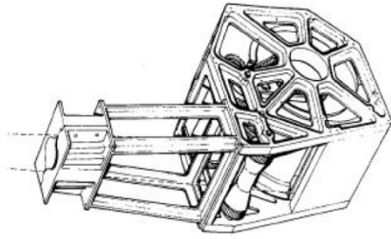

Fig. 8: Deployment module of the CTM-Mast [Source: Sener]



Fig. 9: DLR composite booms of different scale [Source: DLR]

### 3.3 Truss Booms

Truss booms provide higher strength and stiffness than tubular booms; however, these systems are much larger in size and typically require a canister for packaging that exceeds the volume allowed on small satellites. Nevertheless, these truss booms have proven to be highly reliable and efficient for many space missions over the past few decades.

ATK's CoilABLE masts, Fig. 10, have continuous carbon fiber longerons which can be elastically coiled for stowage. For deployment there are two possibilities: A motorized stowage canister which enables deployment without tip rotation; or the stowed package is located at the tip and will rotate during deployment.

The canister guarantees that at least one fully deployed mast segment is attached to the spacecraft so that force transmission is given even in the beginning of deployment phase (for the tip rotation deployment a canister is needed as well but with a lower length). The stowage length for the CoilABLE mast is between 0.5% and 2% of the deployed length but the canister size must be taken into account. The CoilABLE masts were developed for high ratios of bending stiffness to weight and are flight proven [1].

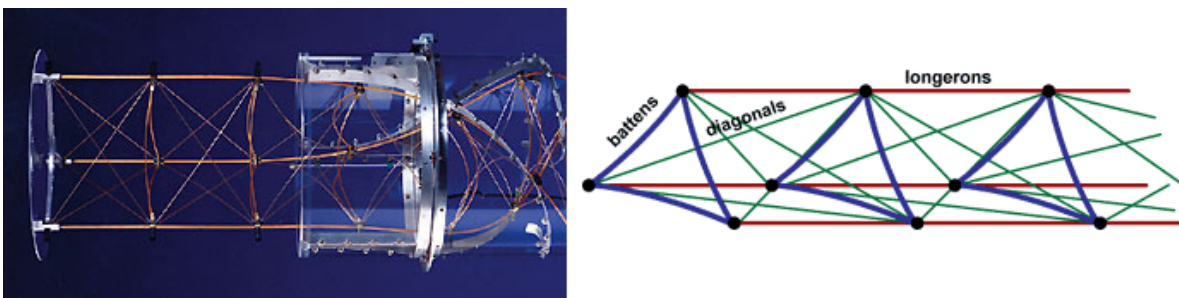

Fig. 10: CoilABLE-Boom during deployment (left) and design sketch (right) [Source: ATK/ABLE Engineering]

ATK's Folding Articulated Square Truss (FAST) and the Able Deployable Articulated Mast (ADAM) masts have much higher strength and stiffness than the CoilABLE boom. However, the higher stiffness results from larger diameters and stiffer components that result in a weight above 1 kg/m.

The ADAM-Mast is rectangular truss developed for applications where a high bending strength and a high geometrical accuracy is required. It is folded in a similar way to the CoilABLE-Boom but without deformation of longerons or battens. Instead each joint is equipped with hinges to connect the longerons. Fig. 11 shows the process of deployment.

The ADAM-Mast is flight proven and was used for example for the SRTM-Mission (Shuttle Radar Topography Mission; STS-99) [NASA Shuttle Radar Topography Mission].

Eight FAST-Masts (see Fig. 12) are currently used on the International Space Stations (ISS) to support the solar arrays. The masts are 32m long, have a diameter of 1.09 m [7] and are deployed out of 2.32 m long containers. Fig. 13 shows the deployment method. Every second batten ring is flexible. Therefore, the battens are able to buckle and two cells of the boom can be collapsed. The deployment is driven by the strain energy of the buckled battens and is controlled by a retaining mechanism in the container.

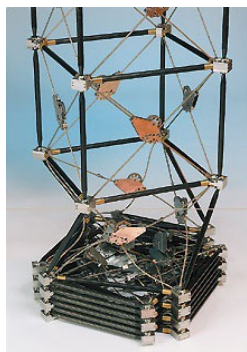

Fig. 11: Beginning deployment of ADAMmast (Source: NASA)



Fig. 12: Deployed FAST mast as used on ISS (Courtesy of Able Engineering – Extracted from [7])

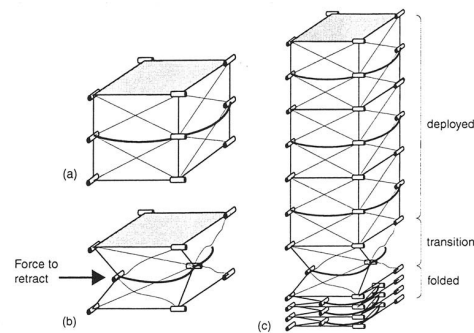

Fig. 13: FAST mast deployment Principle(Extracted from [7] )

The AstroMast developed by Northrop-Grumman is based on a similar concept as ATK's CoilABLE booms. There are only minor differences in truss-architecture, for example the mast is twisted by  $120^\circ$  in the deployed configuration (see Fig. 14). The Solar Sail AstroMast is an untwisted AstroMast with a small sail at its tip and is used to counter disturbance torques on satellites (e.g., asymmetric solar array alignment).

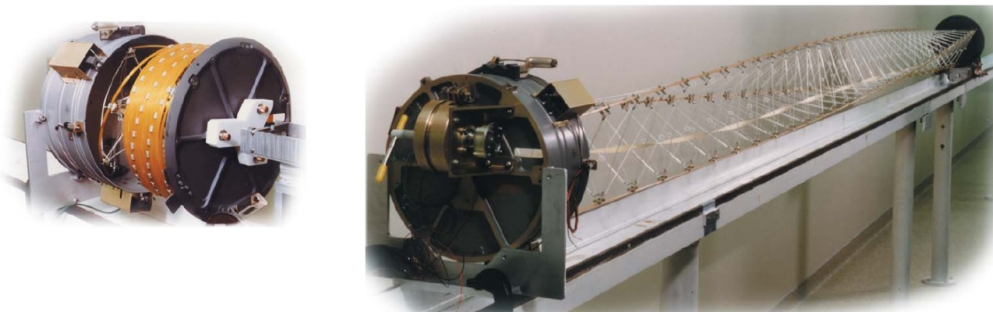

Fig. 14: AstroMast in stowed (left) and deployed configuration (right) [8]

### 3.4 Telescopic Mast

Another type of mast from Northrop-Grumman is the Telescopic Mast (see Fig. 15). An internal mounted STEM-boom drives the deployment and enables retraction [9]. The Telescopic Mast locks in place when deployed and can be provided with a retractability feature. This mast can be sized for various stiffnesses and strengths, based on specific needs. The materials suitable for the mast include aluminum, steel, fiberglass, graphite/epoxy and carbon-carbon.

### 3.5 Triangular Rollable and Collapsible (TRAC) Booms

The Air Force Research Laboratory developed the TRAC boom [10] as shown in Fig. 16. This boom is made of two curved C-shaped section joined along one edge. The TRAC boom is attractive to the CubeSat community due to its extremely efficient packaging scheme. The boom can be constructed from stainless steel or carbon composite laminates. The deployed structural performance of these booms is described in [10].



Fig. 15: Telescopic Mast [9]

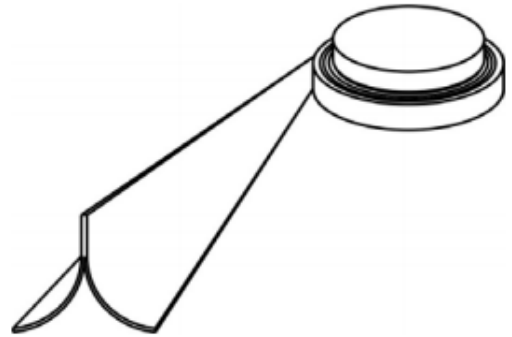

Fig. 16: TRAC Boom [10]

## 4.0 Deployable Thin Shell Composite Booms

Continued development of CTM booms (see section 3.2) using thin ply CFRP composite laminates has been undertaken at DLR and NASA.

DLR developed the booms for the CubeSat DeorbitSail launched in the summer of 2015. In this project, led by Surrey Space Center, U.K., DLR designed, built and qualified new CFRP booms and its deployment system. For this application the booms and mechanism were designed, as depicted in Fig. 17a), to demonstrate rapid deorbiting using a 4 m x 4 m squared drag sail suitable for small size satellites [11]. Several models for testing have been built, as Fig. 17b) shows a full size qualification model displayed at the DLR Space Structure Lab@ Uni in Braunschweig, and qualification testing [12] [13], (see Fig. 17c). Despite the intense qualification and successful launch of DeorbitSail, the deployment of booms and sails could not be realized on-orbit due to software and electronic issues on the spacecraft leaving the mission uncompleted.

With the continued advancement in high strain, thin-ply composite laminates, NASA investigated the use of thin shell composite booms for a Near-Earth Asteroid (NEA) Scout mission [14]. The NEA Scout is a 6U CubeSat being developed for a robotic reconnaissance mission that will be deployed to fly by and return data from an asteroid representative of NEAs



that may one day be human destinations. The booms and deployment mechanism passed all thermal-vacuum testing and post test deployment. Based on the common interests in this class of small satellite boom technology, NASA and DLR will collaborate on developing scalable deployable boom technology for future space missions.

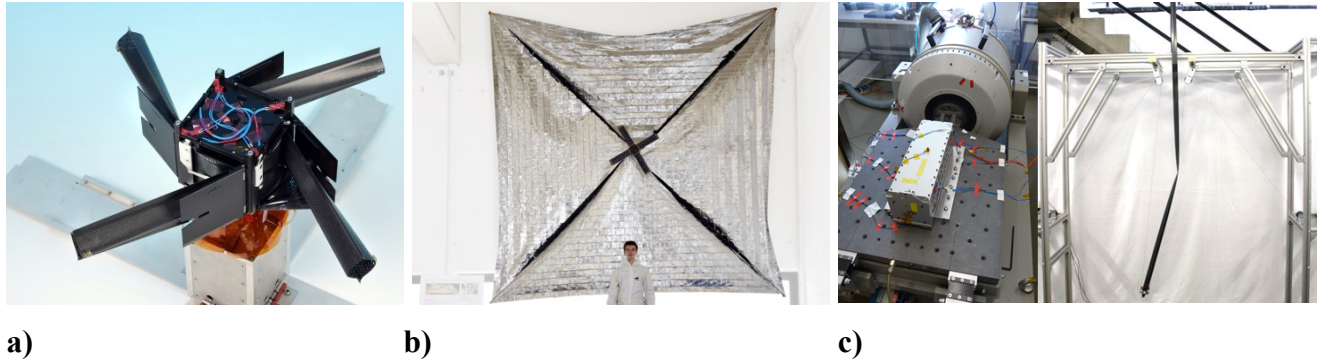

Fig. 17. DeorbitSail deployable structural subsystems: a) DLR developed small CFRP Booms & Deployment module, b) full size Qualification model of DeorbitSail at the DLR Space Structure Lab@ Uni, in Braunschweig, c) testing and qualifying CFRP booms and deployment module in DLR facilities (Source: DLR)

#### 4.0 Collaborative NASA/DLR Project

Current research and development at DLR [15-18] involve: 1) studies of robustness and tolerance of complete structural Gossamer space systems and subsystems; 2) the development and flight qualification of boom, sail and deployment technology for commercial drag-sail applications used as sub-systems on 600-1500 kg class satellites in LEO; and 3) studies on the design of ultra-light weight booms and truss technology for large solar arrays. A large focus at DLR is put on the strategic and important development of new boom technology exceeding current designs and opening new applications as those of PV arrays or membrane antennas for small to medium sized satellites, using the synergy of collaborations with other agencies like NASA.

NASA research and development is focused on low cost, small volume, high structural performance booms that are both predictable and reliably deployed. Specifically, the technical challenges to be addressed by the joint NASA/DLR project include:

- Manufacturability.
- Scalability of boom fabrication methods to tens of meters.
- Packaging in small volumes without failure (damage initiation and propagation)
- Behavior of materials at very high strain states (beyond ASTM testing standards).
- Use of new thin-ply materials with low micromechanical behavior knowledge (braids, spread-tow fabrics, CNT, hybrid laminates).
- Material (radiation tolerance, permeability, moisture absorption, micro-cracking).
- Creep/stress relaxation during long-term stowage (boom shape, deployment force and dynamics predictability).
- Durability of bonded/stitched sections.

- Long-term aging in space environment.
- Achievement of bi-stability effects in booms other than cylindrical shaped.
- Numerical models for large systems that cannot be fully tested on the ground.
- Testing and characterization of lightweight structures under a 1g environment.

The collaborative project will target 5-20 meter deployable booms with the following design requirements for small satellite applications:

- Stiffness
  - The stowed structure shall have a first Eigen frequency of 100Hz or higher
  - The deployed structure shall have a first Eigen frequency of 0.05Hz or higher
- Strength
  - The stowed structure will withstand the static and dynamic loads
  - The deployed structure will withstand all expected thermo mechanical loads
- Thermal stability
  - The structure shall be designed in a way that it fulfills criteria on pointing accuracy and surface quality under all mission relevant environments
- Scalability
  - The structural concepts shall be scalable or modular in order to react on changed demands for surface area
- Manufacturability
  - Processes that are cost efficient, repeatable, and with known tolerances

The three year collaborative project will conclude with testing of one or more advanced deployable boom concept(s) (ground and parabolic flights) to achieve a technology readiness level (TRL) of 6 (DLR STM level). The following tests are anticipated:

- Boom stiffness and strength characterization
- 1-g functional deployment tests with optional gravity compensation
- Thermal vacuum and vibration tests of the stowed system
- Partial or full deployment tests in a
- 0-g functional deployment tests during parabolic flight campaign (see Fig. 18)

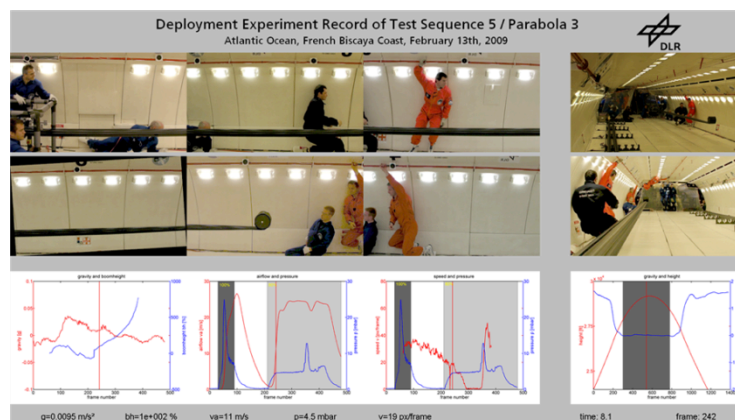

Fig. 18. Exemplary frame of a DLR parabolic flight campaign from 2009 used to verify different deployment control principles for DLR composite booms [19]

#### 4. SUMMARY

Small satellites of the future may provide comparable or even better performance than much larger satellites of the past. One of the key challenges for small satellites is packaging and reliable deployment of structural booms and arrays used for power, communication, and scientific instruments. The lack of reliable and efficient boom and membrane deployment concepts for small satellites is addressed in this work through a collaborative project between NASA and DLR.

The state of the art and recent experience in deployable booms for small satellites shows a technology gap for booms 5-20 meters in length that can be stowed in small volumes (e.g. 3U CubeSats). The project will advance at least one boom concept to TRL 6 by 2019 that meet the following goals:

- Satisfy unique requirements of Small Satellites (volume, mass, and power)
- Maximize ground testability
- Permit the use of low-cost manufacturing processes;
- Be scalable for use as elements of hierarchical structures (e.g., trusses)
- Have high deployment reliability
- Have controlled deployment behavior and predictable deployed dynamics.

Tubular thin walled shell composite booms offer the promise of high specific strength and stiffness and very good thermal stability. Initial analysis based designs are underway and hardware prototypes are in development. Static and dynamic ground tests will be used to verify the boom strength and stiffness. Modeling and simulation will be used for design and to characterize nonlinear thermal/mechanical response. Zero gravity tests will be used to verify deployment forces and reliability of the boom and deployment mechanisms.

The end goal is to fill the technology gap for small satellite deployable booms with technology that is predictable, testable, and reliable.

#### REFERENCES

- [1] C. H. Jenkins, Recent Advances in Gossamer Spacecraft, Vol. 212, Progress in Astronautics and Aeronautics Series, 212, AIAA, 2006, p. 344.
- [2] C. Sickinger, Verifikation entfaltbarer Composite-Booms für Gossamer-Raumfahrtsysteme, Dissertation, Technische Universität Carolo-Wilhelmina zu Braunschweig, Mar 2009, Publisher: Shaker, ISBN: 978-3-8322-8049-9.
- [3] M. Straubel, Design and Sizing Method for Deployable Space Antennas, Dissertation, November 2012, DLR.
- [4] M. W. Thomson, Deployable and Retractable Telescoping Tubular Structure Development, AIAA, AHS and ASEE, Aerospace Design Conference, Irvine, CA, 1993.
- [5] F. Del Campo and J. I. R. Urien, Collapsible Tube Mast Technology Demonstration Program, Space Technology-Industrial and Commercial Application, pp. 61-76, Jan {1993}.

- [6] ESA/ESTEC, CTM Technology Demonstration Programme Bridging Phase – Final Report, 1991.
- [7] G. Tibert, Deployable Tensegrity Structures for Space Application, Stockholm, Sweden, 2003. Technical Report 2002:04 ISSN 0348-467X.
- [8] N. Grumman, *AstroMast Data-Sheets DS307 and DS407*, 2010.
- [9] N. Grumman, *Telescopic Mast Data-Sheet DS401*, 2010.
- [10] Banik J., Murphey, T., Performance Validation of the Traingular Rollable and Collapsible Mast, 24th AIAA/USU Conference on Small Satellites, Logan, UT, August 2010.
- [11] M. Hillebrandt, S. Meyer, M. E. Zander, M. Straubel and C. Hühne, The Boom Design of the DE-ORBIT Sail Satellite, Braunschweig, Germany, ESA/DLR/CNES, 2014.
- [12] M. Hillebrandt, S. Meyer, M. E. Zander, C. Hühne and M. Sinapius, Mechanical Characterization of Deployable Thin Shell CFRP Booms for CubeSat DE-ORBIT Sail, Braunschweig, Germany, ESA/DLR/CNES, 2014.
- [13] M. E. Zander, M. Hillebrandt, M. Sinapius and C. Hühne, Mechanical Characterization of Deployable Thin Shell CFRP Booms for the CubeSat DE-ORBIT SAIL, Jerusalem, Israel, IAF International Astronautical Federation, 2015.
- [14] J. M. Fernandez, Advanced Deployable Shell-based Composite Booms for Small Satellite Applications, European Conference on Spacecraft Structures, Materials and Environmental Testing, Toulouse, France, September 2016.
- [15] M. E. Zander, A. Wilken, M. Sinapius and C. Hühne, Mechanical Testing of Deployable Thin Shell CFRP Booms in Ideal and Realistic Interfaces for the Solar Sail Demonstrator GOSSAMER-1, Toulouse, France, ESA/DLR/CNES, 2016.
- [16] M. Straubel, P. Seefeldt, P. Spietz and C. Huehne, The Design and Test of the GOSSAMER-1 Boom Deployment Mechanisms Engineering Model, *2nd AIAA Spacecraft Structures Conference*, Kissimmee, FL, USA, 2015.
- [17] S. Meyer, M. E. Zander, M. Straubel and C. Hühne, Envirionmental Testing and Analysis of a Boom Deployment Mechanisms for GOSSAMER-2, Jerusalem, Israel, IAF International Astronautical Federation, 2015.
- [18] M. Straubel, M. Hillebrandt and C. Hühne, Evaluation of Different Architectural Concepts for Huge Deployable Solar Arrays for Electric Propelled Spacecraft, in *14th European Conference on Spacecraft Structures, Materials and Environmental Testing*, Toulouse, France, 2016.
- [19] M. Straubel, M. Sinapius and S. Langlois, On-Ground Rigidised, Deployable Masts for Large Gossamer Space Structures, in *European Conference on Spacecraft Structures, Materials & Mechanical Testing*, Toulouse, France, 2009.