

"Voyage"
is about as
close as I got to
astronomy during a
30 year career as an
artist, so it is a privilege
and an honor to stand
here before you as a
peer in this queen
of sciences.



Jeffrey Foster Friedman
Universidad de Puerto Rico

Michael S. Foster
Spectratek

Jeffrey T. Baker
Baker Adaptive Optics

David Mozurkewich
Seabrook Engineering

Leonid Goray
International Intellectual Group

Jason Warren
(IBM)

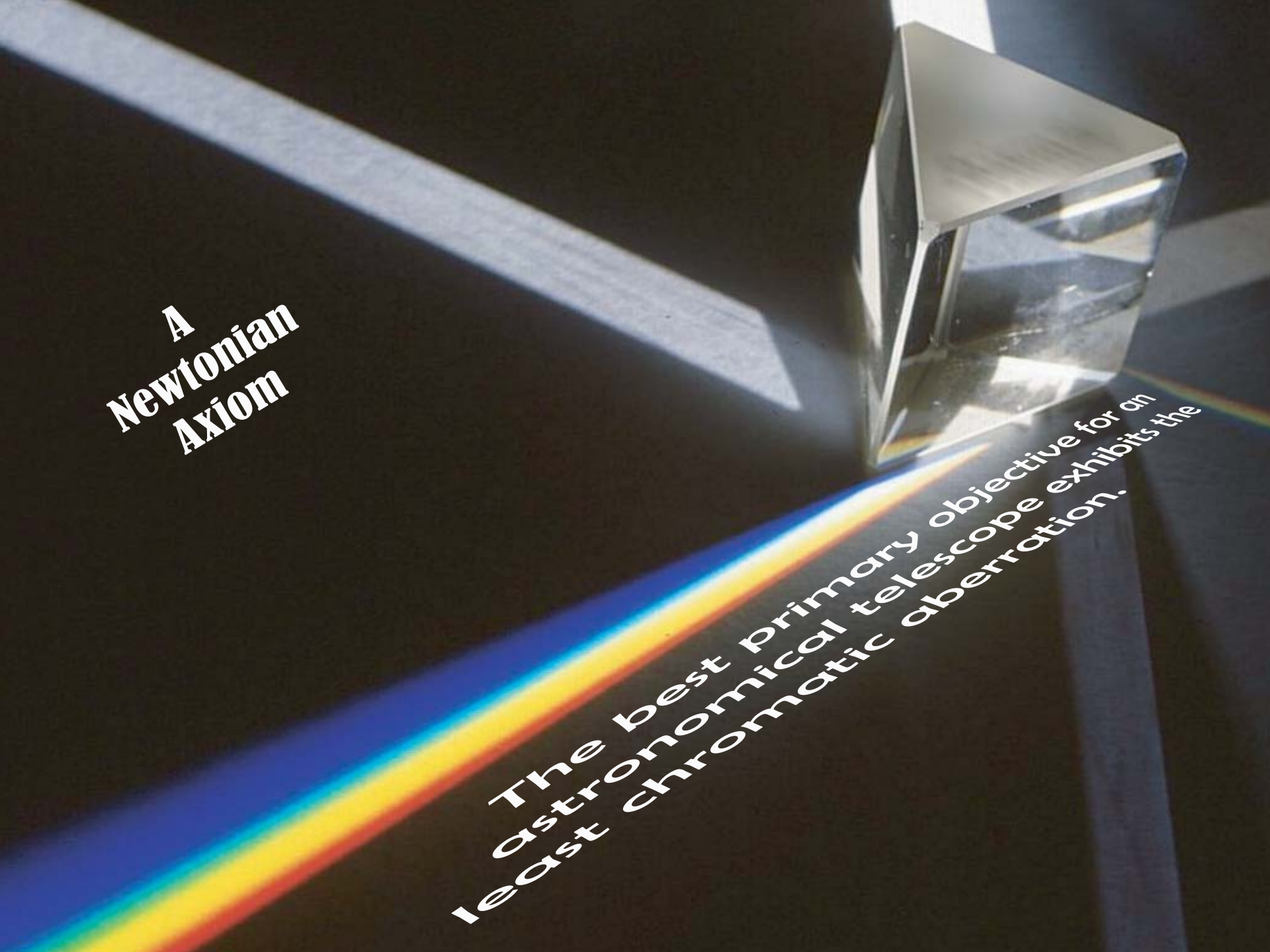
A Newtonian Axiom advertisement. The background is dark with a bright, diagonal beam of light entering from the top left. A clear glass prism is positioned in the upper right, dispersing the light into a vibrant rainbow spectrum that runs diagonally across the lower half of the image. The text is white and set against the dark background.

**A
Newtonian
Axiom**

**The best primary objective for an
astronomical telescope exhibits the
least chromatic aberration.**

1600

1650



1700

1750

1800

1850

1900

1950

2000

2050

2100

This Report is not the latest word on an old idea but the first word on a new one. The new idea reverses the old one, the axiom that the best primary objective for an astronomical telescope exhibits the least chromatic aberration. That axiomatic distinction goes back to a young Isaac Newton who knew from experiments with prisms and mirrors in the 1660's that magnification with a reflection primary was completely free of the dispersion he saw with refraction. The superiority of reflection primary objectives for eyeball or photographic viewing is now considered obvious.

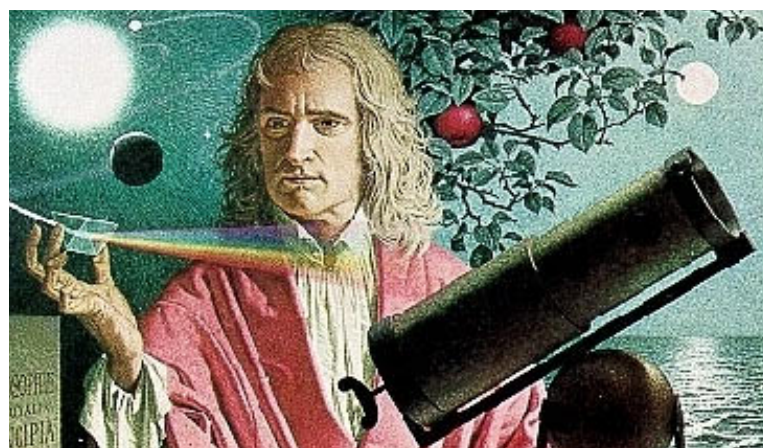

It was this piece of wisdom on achromatic primary objectives that led to the dominance of the parabolic mirror as the means to collect star light. Newton was aware of the problem when he introduced his telescope to the scientific world in 1670.

1600

1650



1700

1750

1800

1850

1900

1950

2000

2050

2100

Actually, Newton's design innovation was in a secondary mirror, a plane mirror far more easily fabricated than Gregory's embodiment of 1663 which required two curved mirrors.

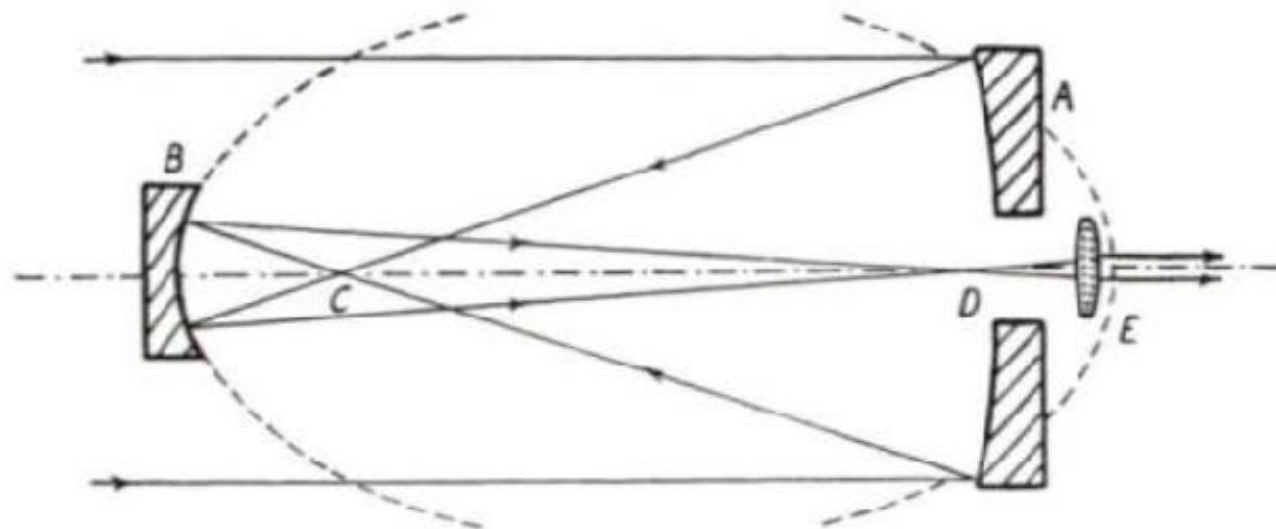

Fig. 33—The Gregorian reflector

A is the primary mirror, a concave paraboloid centrally perforated. *B* is the secondary concave ellipsoid. Light from a star is sent towards *C*, the joint focus of *A* and *B*, and reflected to *D*, the other focus of the ellipsoid. The image at *D* is then observed with an eyepiece, shown as a single equi-biconvex lens *E*.

1600

1650

1700

1750

1800

1850

1900

1950

2000

2050

2100



Mersenne's earlier dual parabolic mirror design of 1636 would also have been free of chromatic aberration, spherical aberration, coma, and astigmatism, if it could have been built. When Descartes saw the proposal he dismissed the idea. Mersenne returned to the monastery where he worked with prime numbers rather than prime objectives. Yet, this design is central to telescope design today.

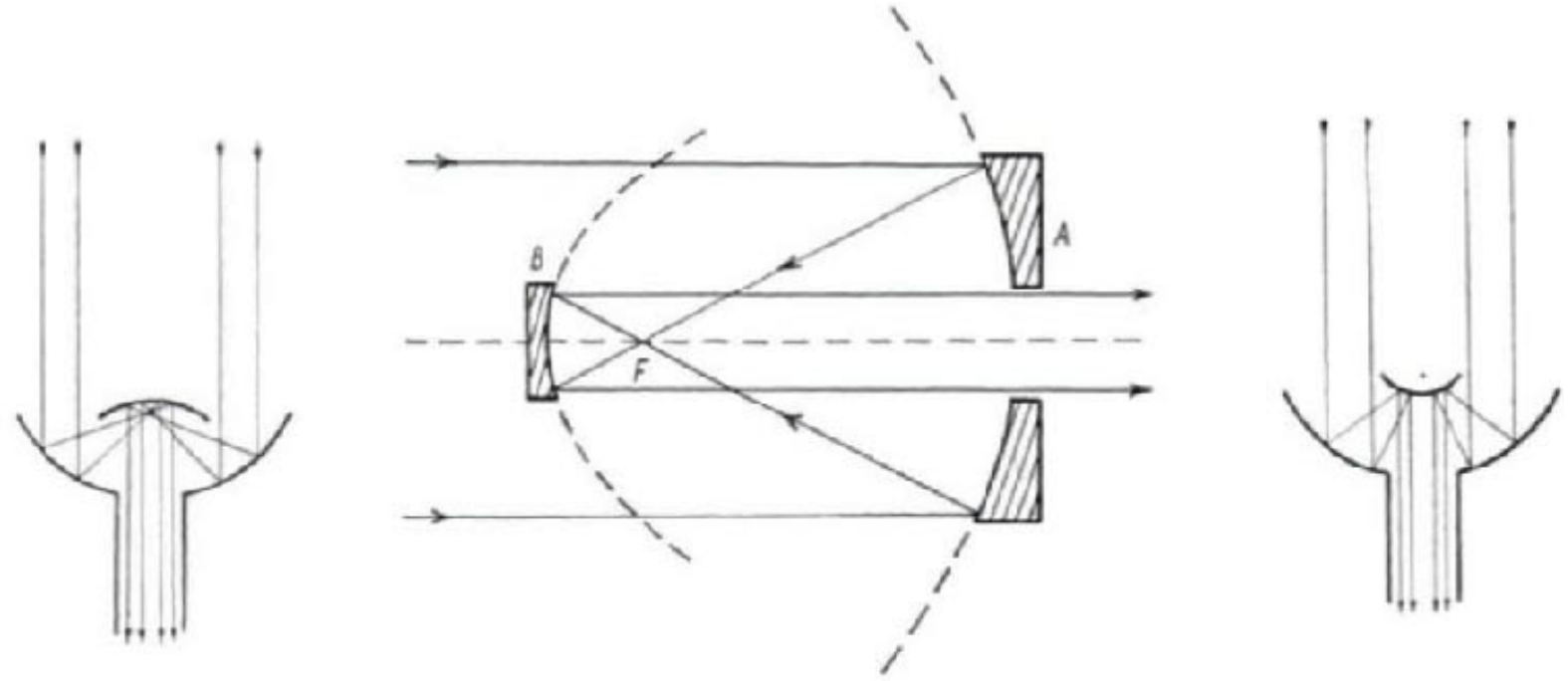

Mersenne 1636

The latency in the development of the diffraction grating partially explains why it did not even enter into consideration as a primary objective of telescopes. The first diffraction grating recorded in the literature appears in 1786, over 100 years after Newton's telescope, It was the work of the American clockmaker and astronomer, David Rittenhouse, who wound fibers at 106 to the inch. He characterized the multiple diffraction orders and observed that colors were bent in the inverse order of refraction.

A PROBLEM IN OPTICS.

The Answer, by Mr. RITTENHOUSE.

In order to make my experiments with more accuracy, I made a square of parallel hairs about half an inch each way. And to have them nearly parallel and equidistant, I got a watchmaker to cut a very fine screw on two pieces of small brass wire. In the threads of these screws, 106 of which made one inch, the hairs were laid 50 or 60 in number. Looking through these hairs at a small opening in the window shutter of a dark room, $\frac{1}{7}$ of an inch wide

I was surprized to find that the red rays are more bent out of their first direction, and the blue rays less; as if the hairs acted with more force on the red than on the blue rays, contrary to what happens by refraction, when light passes obliquely through the common surface of two different mediums. It is, however, consonant to what Sir

properties of this wonderful substance, light, which animates all nature in the eyes of man, and perhaps above all things disposes him to acknowledge the Creator's bounty. But want of leisure obliges me to quit the subject for the present.

I am, dear sir, your affectionate friend,
And very humble servant,
DAVID RITTENHOUSE.

1600
1650
1700
1750
1800
1850
1900
1950
2000
2050
2100



Fraunhofer solar absorption lines

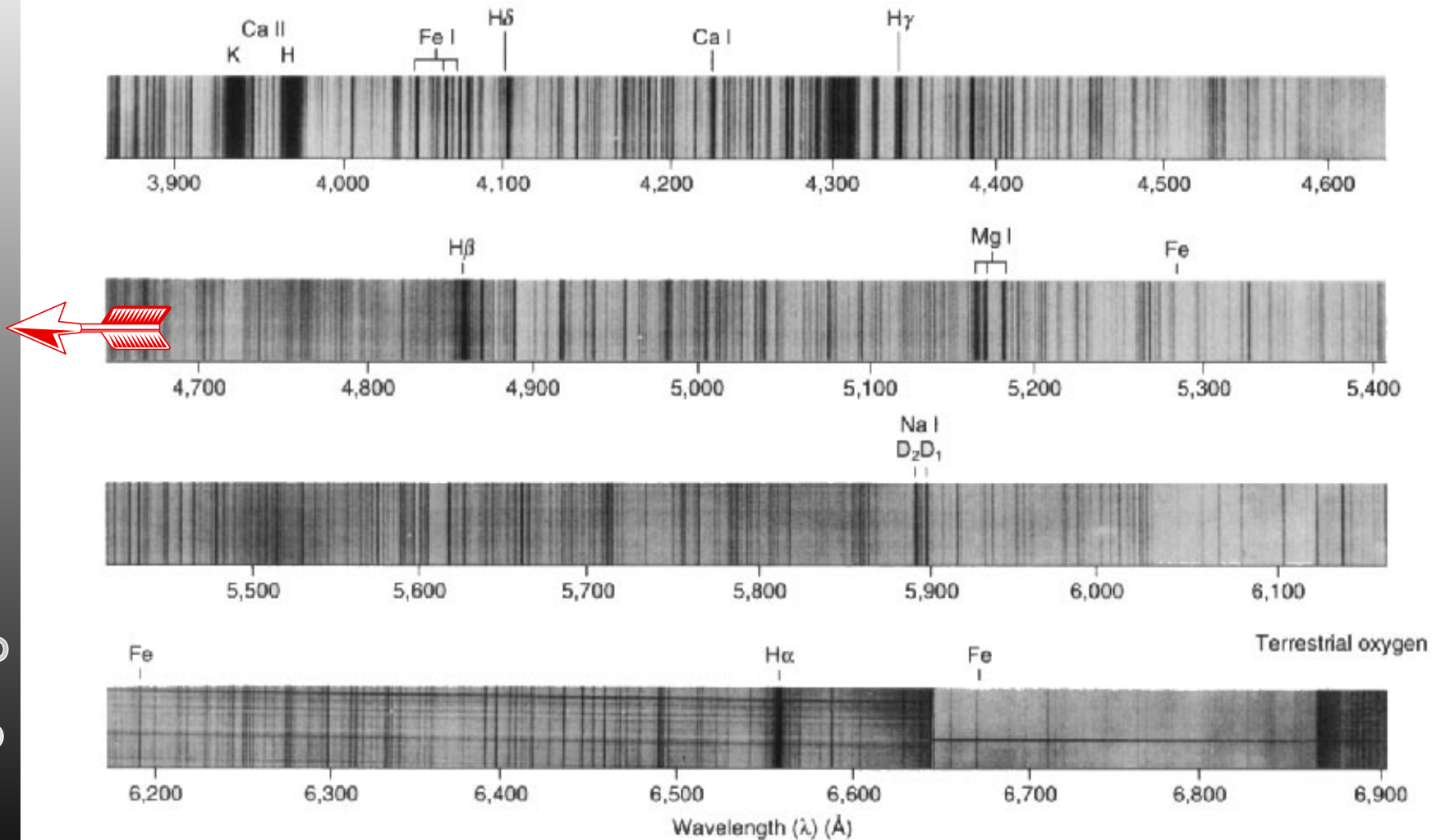

After Rittenhouse, dispersion by diffraction grating was not considered again for 35 years until 1820 when Joseph von Fraunhofer reinvented it. He also used dispersion to resolve atomic lines of sunlight and starlight, showing both similarities and unique differences between stars. Astronomers took note.

1600
1650
1700
1750
1800
1850
1900
1950
2000
2050
2100

One way plane gratings served astronomy was when they reached sizes large enough to form images. Seemingly excellent for surveys, these so called "slitless" spectrometers suffered from low resolving power, ambiguity between overlapping spectra and intrinsic background noise. Not only that. These primary objective gratings did nothing to concentrate the light. That work was left to a secondary mirror or lens where the concentration of flux took place.

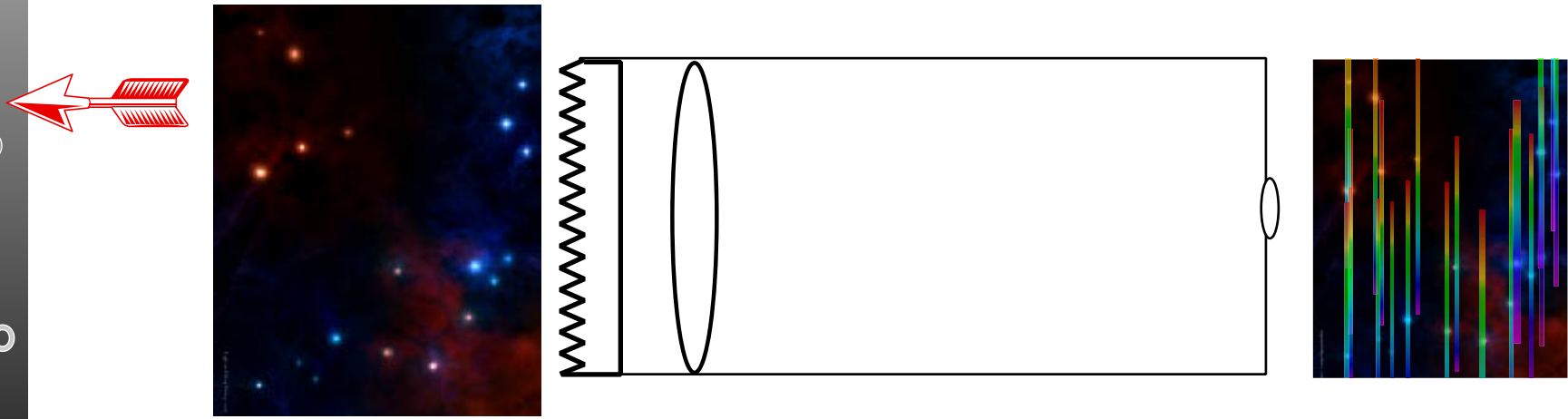

Objective grating multiple object spectroscopy

This type of spectroscopy was largely abandoned, save for the occasional exotic application where these defects did not overrule the convenience of putting the grating first.

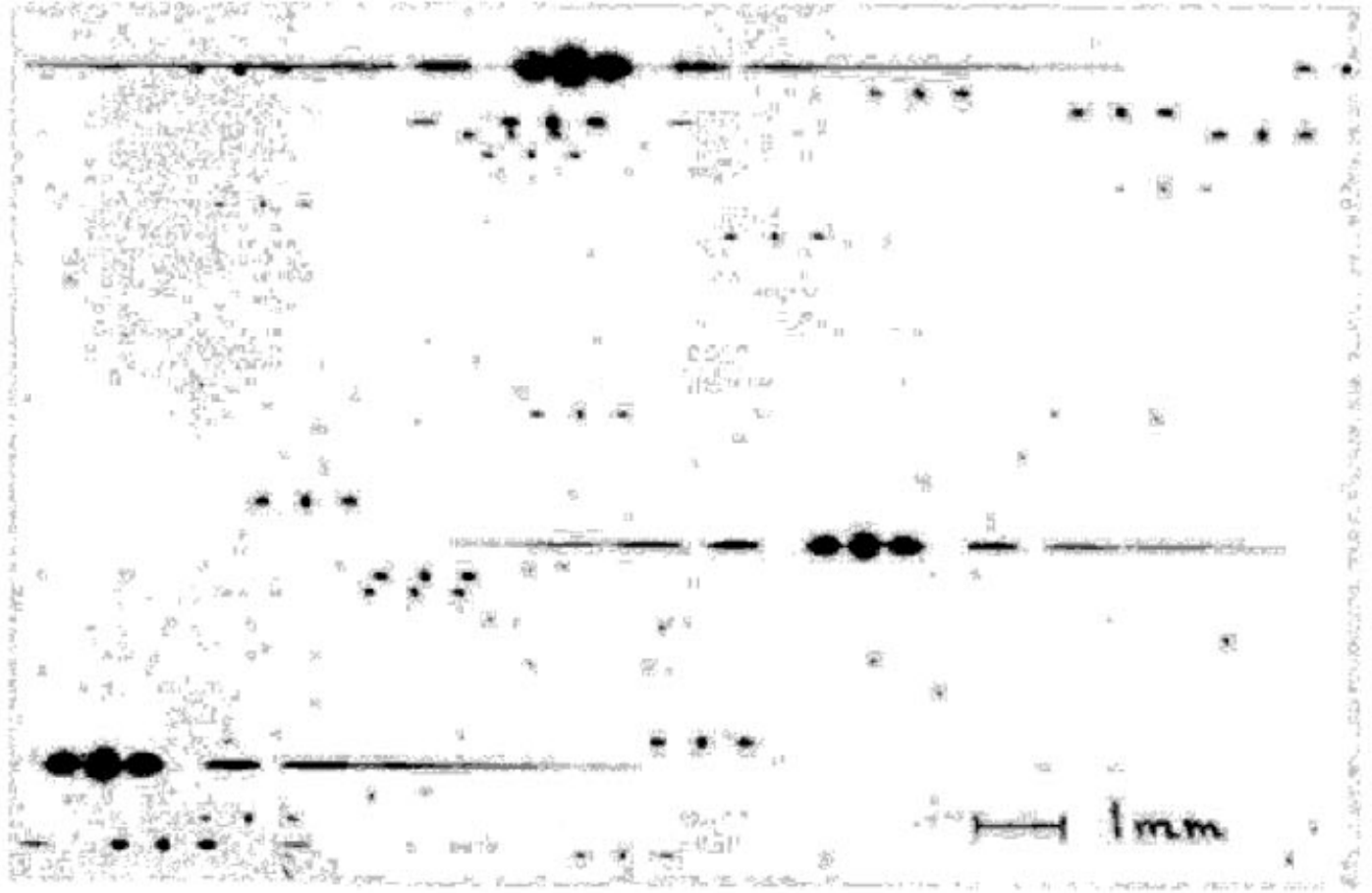
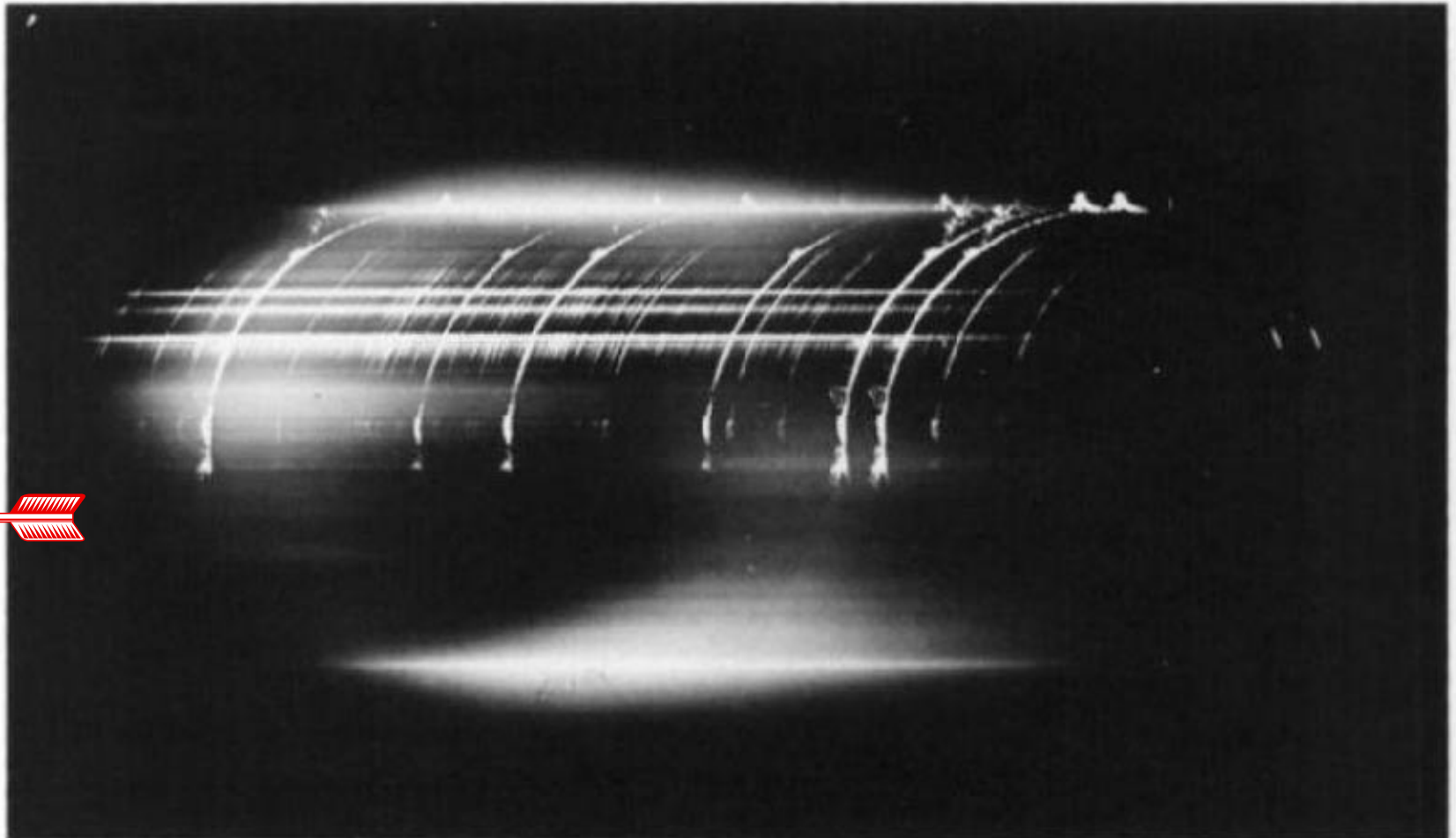

Fig. 4.22 Grating spectra of part of the Pleiades recorded by Ejnar Hertzsprung, Dec. 1907.

Objective grating multiple object spectroscopy

The most common use is solar observation.

1600
1650
1700
1750
1800
1850
1900
1950
2000
2050
2100



Objective grating multiple object spectroscopy

1600
1650
1700
1750
1800
1850
1900
1950
2000
2050
2100

Multiple object spectrometers use slices to reposition each target onto a separate section of the secondary spectrometer. Aligning the lens or mirror array to perform the slicing is dicey, because stars are randomly distributed in the field-of-view.

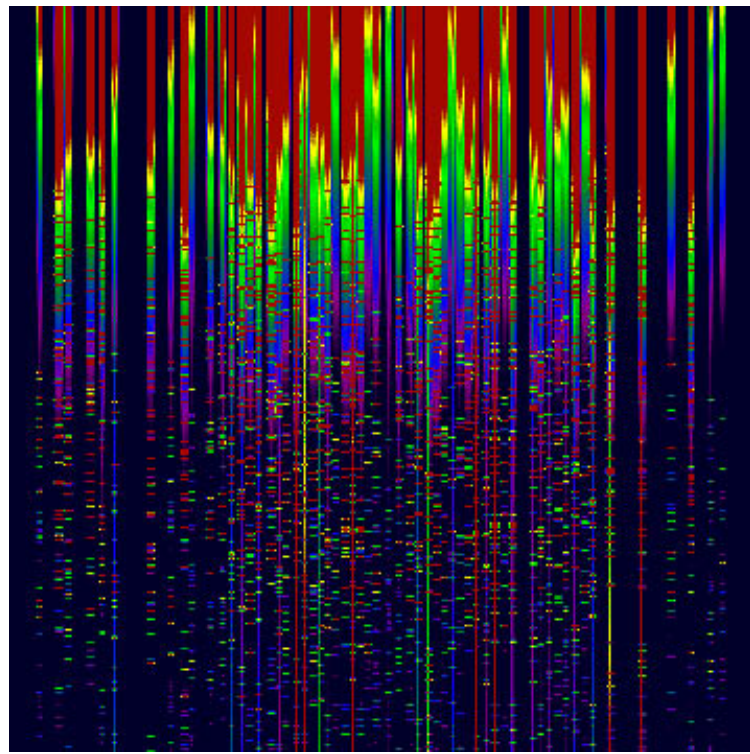
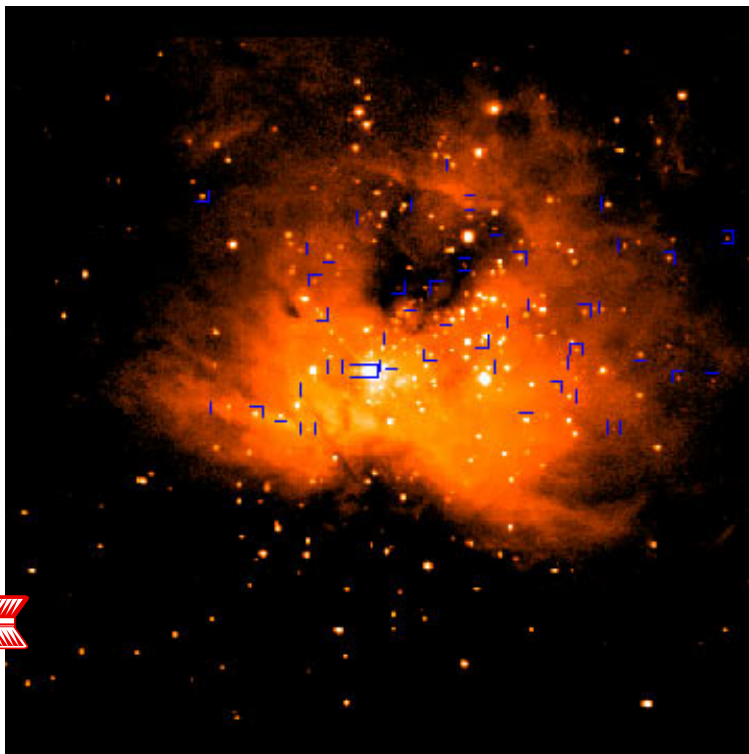

FLAMINGOS: The FLoridA Multi-object Imaging Near-IR Grism Observational Spectrometer

Simulated

Focal plane multiple object spectroscopy

1600
1650
1700
1750
1800
1850
1900
1950
2000
2050
2100

Just as the original slitless objective grating suffered from ambiguities of overlapping spectra, the focal plane multiple-object spectrometer is faced with similar interleaving despite its numerous alternative ray paths. Background photon noise is not eliminated, and the convenience of having a single instrument that captures all stars in a field-of-view is a compromise.

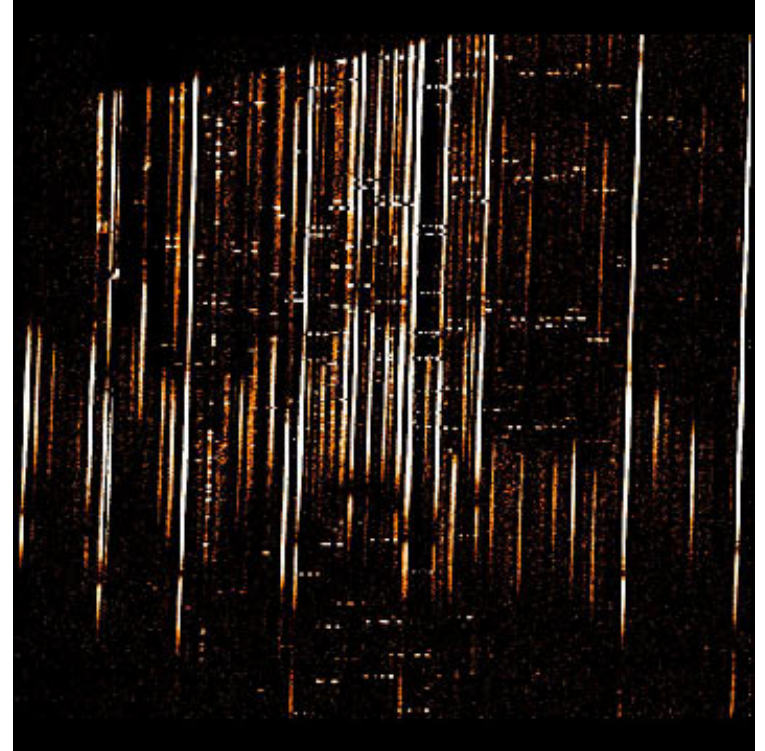
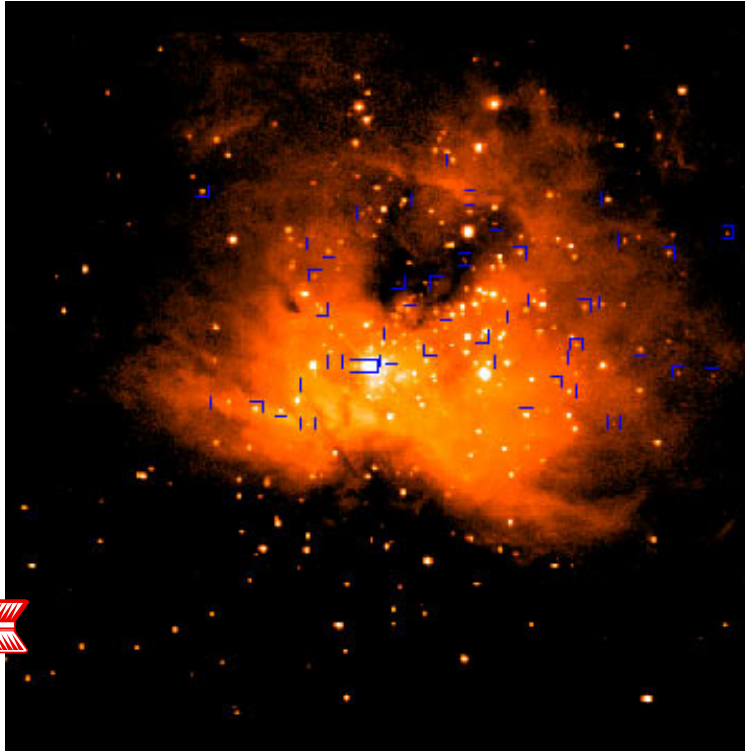

FLAMINGOS: The FLoridA Multi-object Imaging Near-IR Grism Observational Spectrometer

Actual

Focal plane multiple object spectroscopy

This is the Sloan Digital Sky Survey telescope. It has a fiber fed multiple object spectrometer capable of taking 600 spectra during an observation cycle. In order for it to work, there must first be a photograph of the target field. Once candidates are selected for spectrograms, a metal plate is drilled out with fiber ferrule holders mounted at each target site. On the photogrammetric nights when spectra can be taken, the plates are swapped in and out of the telescope after each field is acquired. The alignment must be perfect, because the metal plate is an exact copy of the star field. The best performance in a knock down drag out night with a spectrometry crew was 6000 spectra.

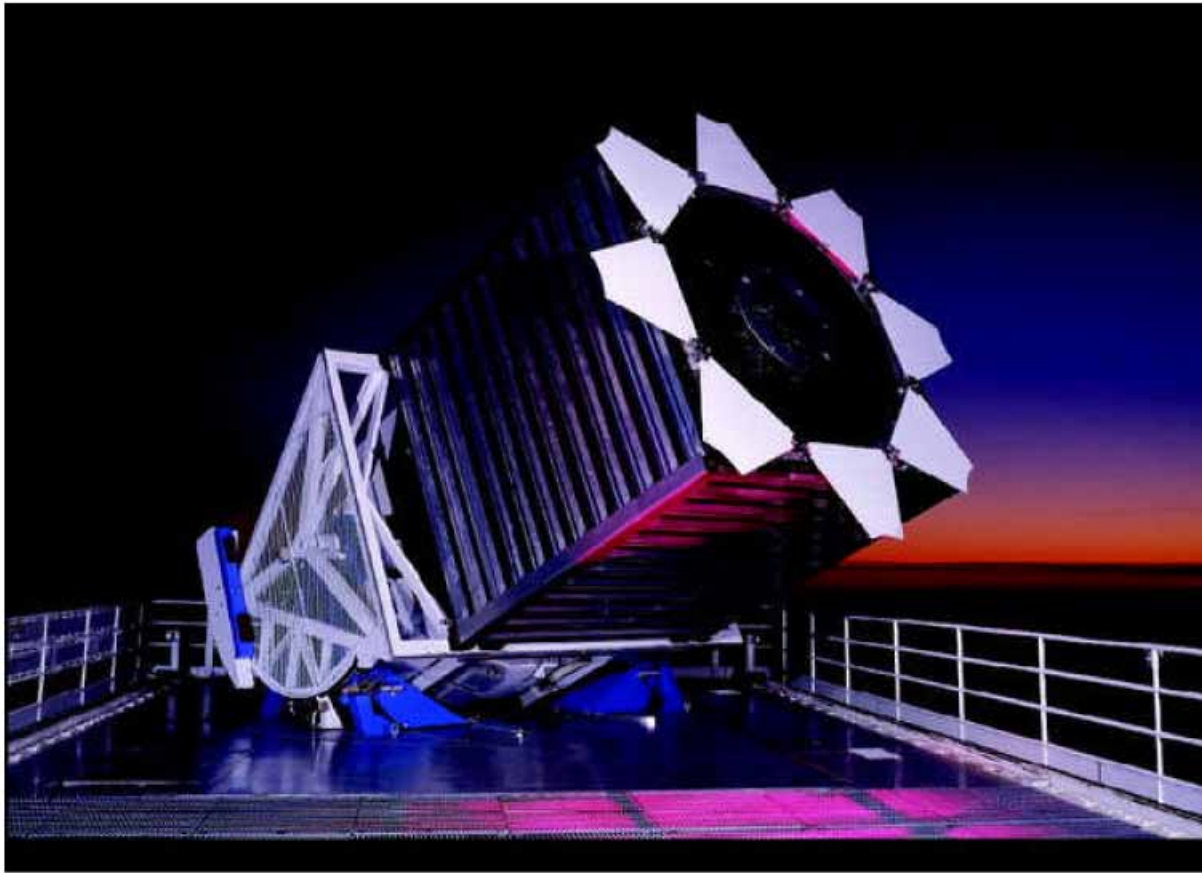

Focal plane multiple object spectroscopy

1600
1650
1700
1750
1800
1850
1900
1950
2000
2050
2100

Recently, Jian Ge's group adapted their Keck ET Doppler interferometer to the SDSS fiber optic focal plane. This gives a good impression of how difficult it is to fabricate and load the instrument.

New color coded Keck ET fibers plugged into the SDSS fiber cartridge ready for Doppler detection of new planets in Mar. 2006

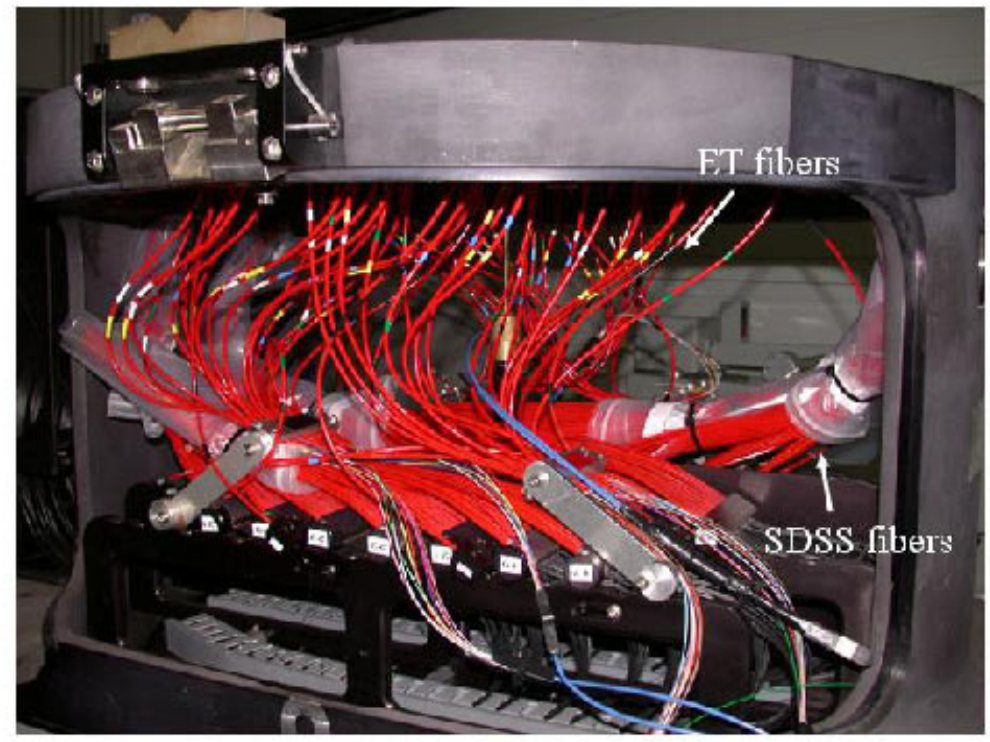

Focal plane multiple object spectroscopy

Another important limitation of traditional telescopes is their pointing mechanism. Gimballed mounts that counteract the rotation of the earth overcame the clumsy hanging fixtures that first elevated the primary above the secondary. Today huge exoskeletal frames hold the optics, and the enclosure pirouettes delicately to provide an open aperture in the roof. The cost of such mechanisms has begun to outstrip the very optics they hold and protect.

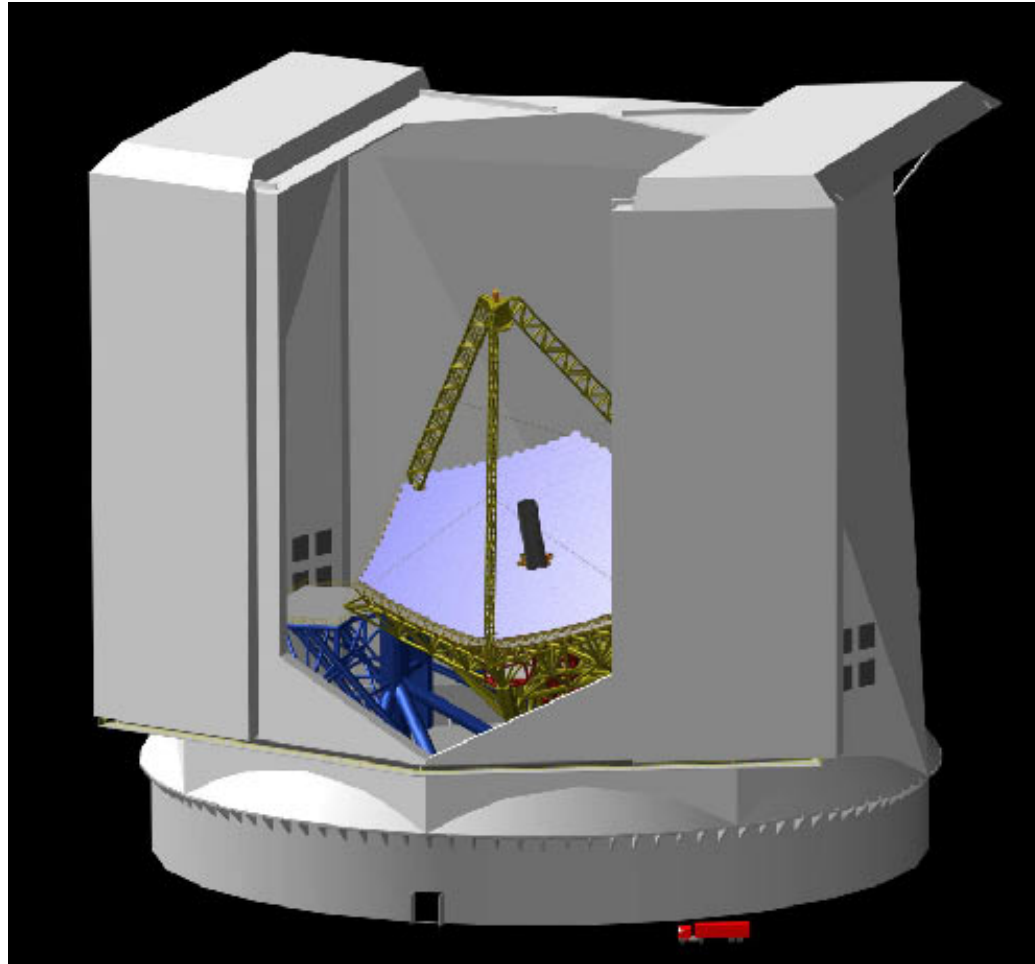

Euro-50 - abandoned

The infra-structure cost more than the mirror.

1600

1650

1700

1750

1800

1850

1900

1950

2000

2050

2100

Here's another axiom. "The bigger the primary objective the greater the theoretical resolving power and light amplification." There are a few ten meter scale astronomical telescopes in use today, but there is pressure to grow the size of the primary objective to 25 meters and beyond. In space applications, NASA is committed to growing the size of the primary from 2 meters to 6 meters. Size matters.

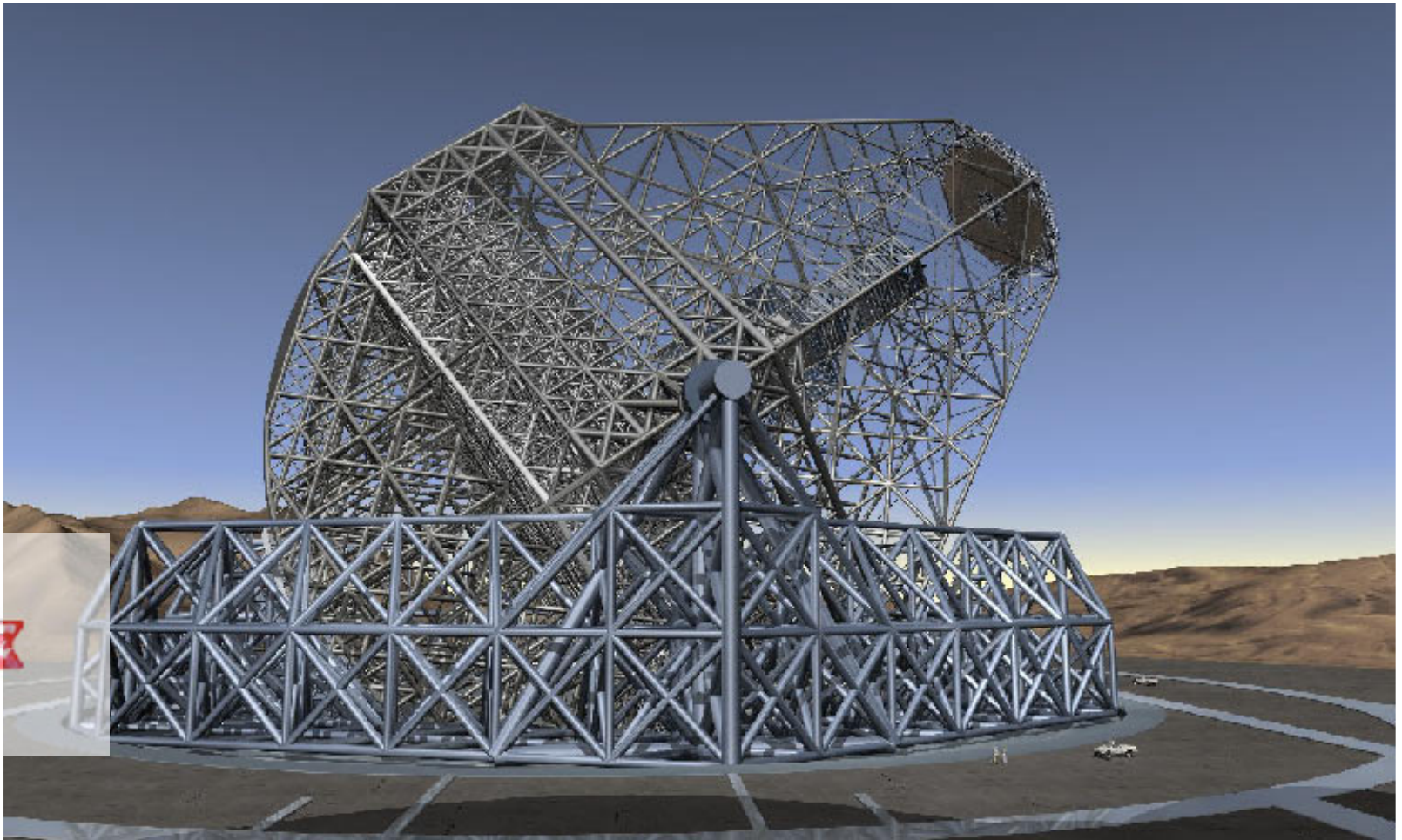

Bigger is heavier

100 meter mirror - 1500 metric tons

OWL - abandoned



Primary Objective Grating Astronomical Telescope

Thomas D. Ditto

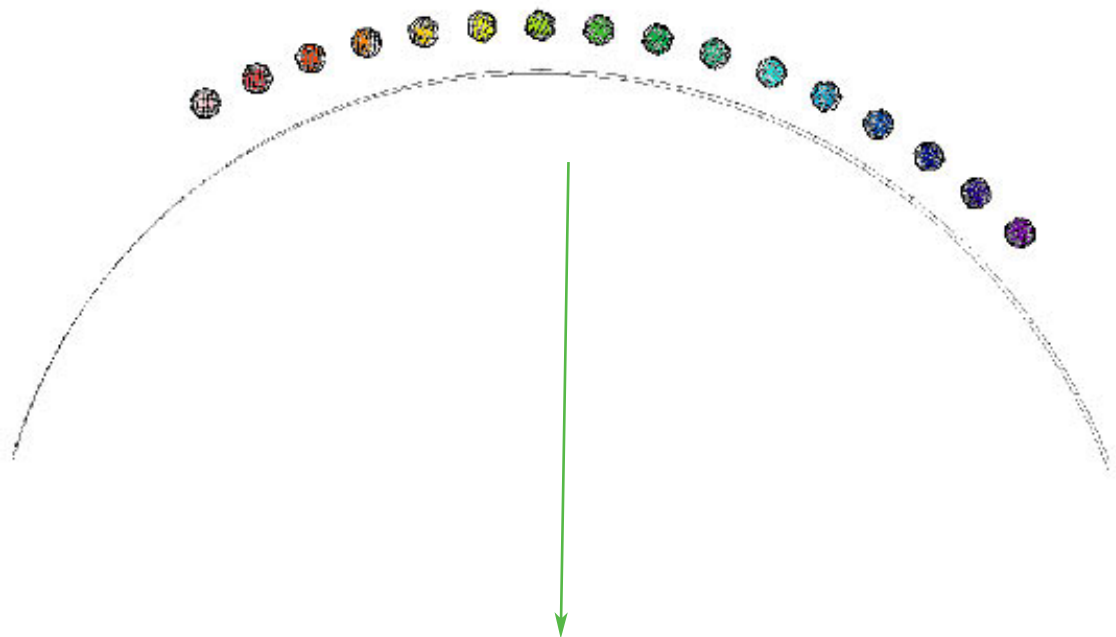

Consider a ray originating from an object at the zenith.

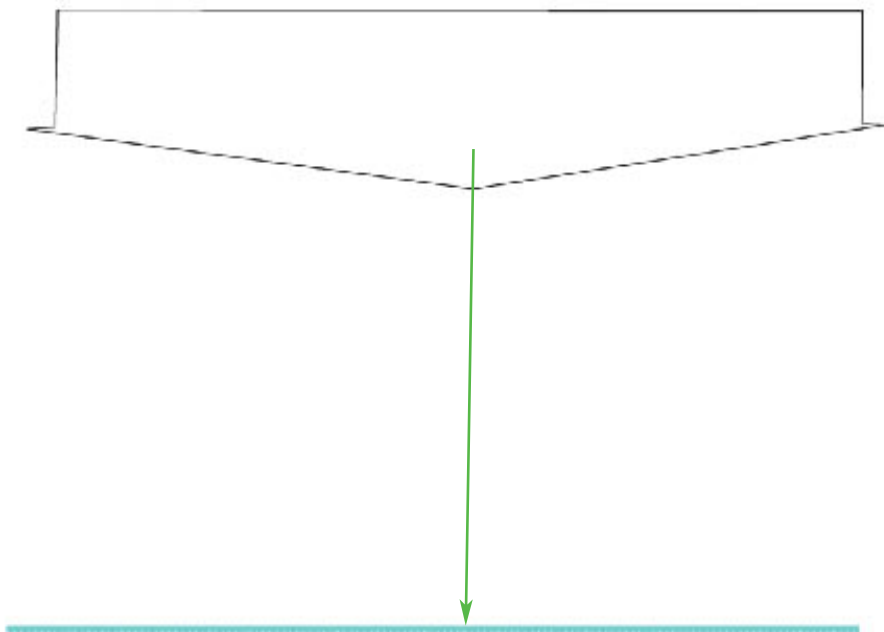

A Dittoscope... (Pardon the shorthand designation). A Dittoscope has a primary objective grating

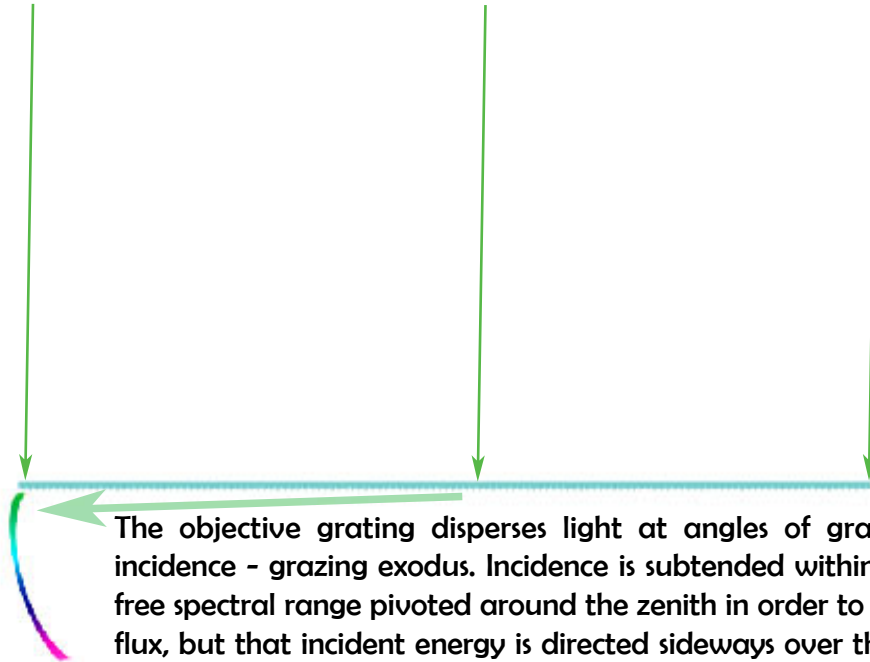

The objective grating disperses light at angles of grazing exodus - not incidence - grazing exodus. Incidence is subtended within the bounds of the free spectral range pivoted around the zenith in order to maximize collected flux, but that incident energy is directed sideways over the grating plane at a grazing angle toward the receiver.

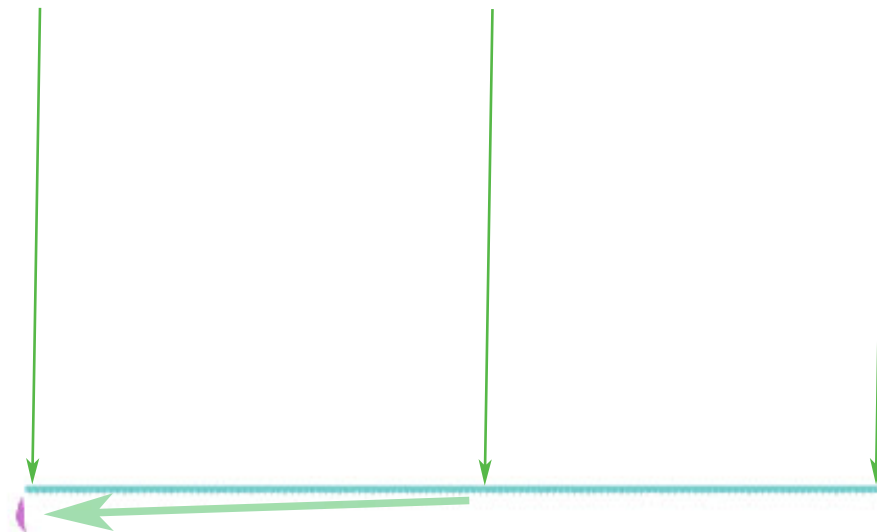

The ratio of the collection area of the primary to the area of the secondary can be 1000:1 as the angle of reconstruction of a higher-order approaches 90 degrees.

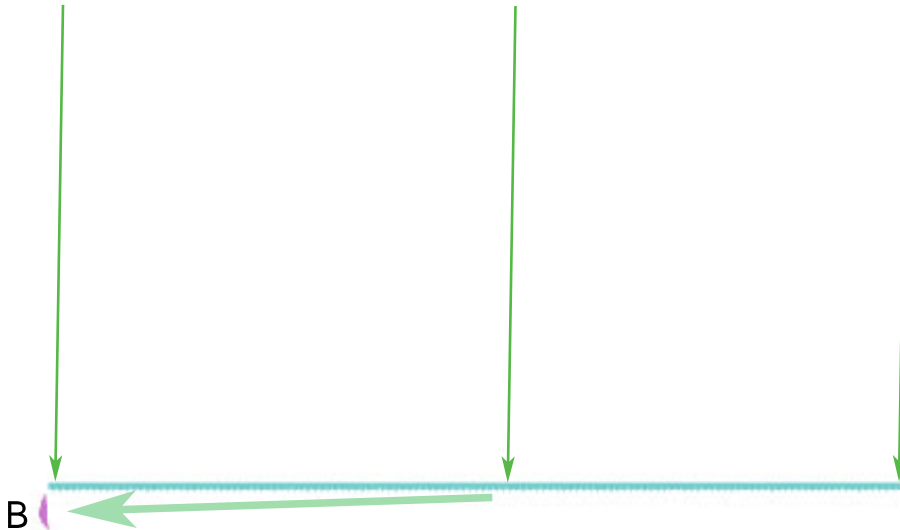

A ribbon shaped grazing exodus primary objective grating with a ten meter secondary mirror may have 1 kilometer length and a collection area of 10,000 square meters.

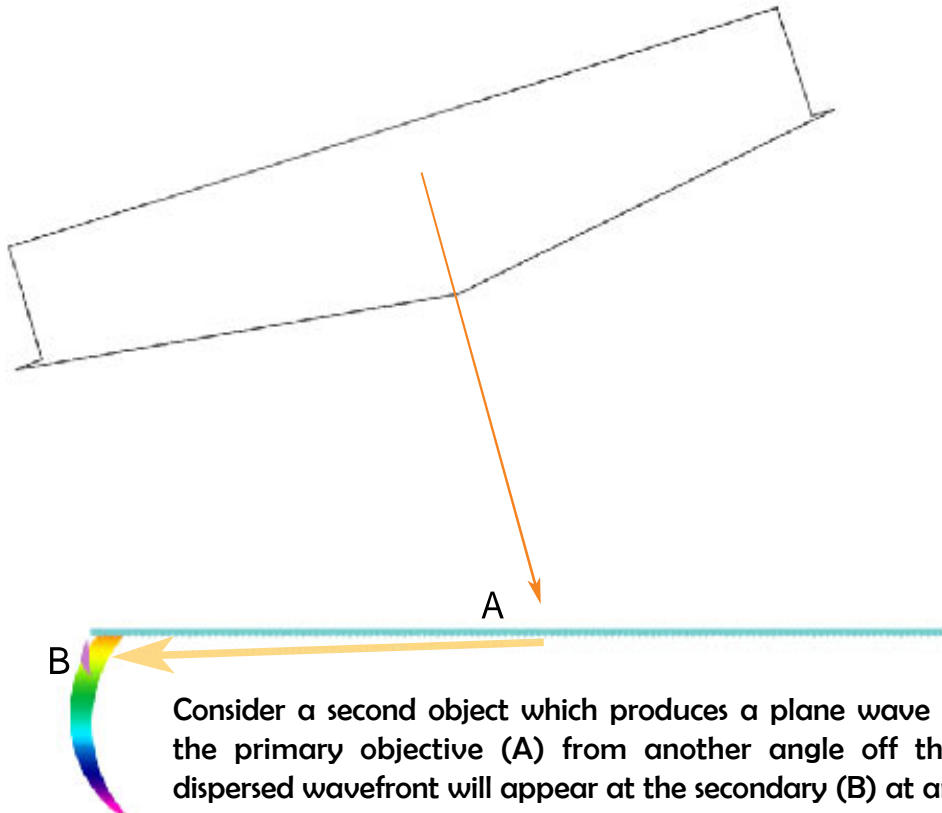

Consider a second object which produces a plane wave incident upon the primary objective (A) from another angle off the normal. Its dispersed wavefront will appear at the secondary (B) at another specific wavelength.

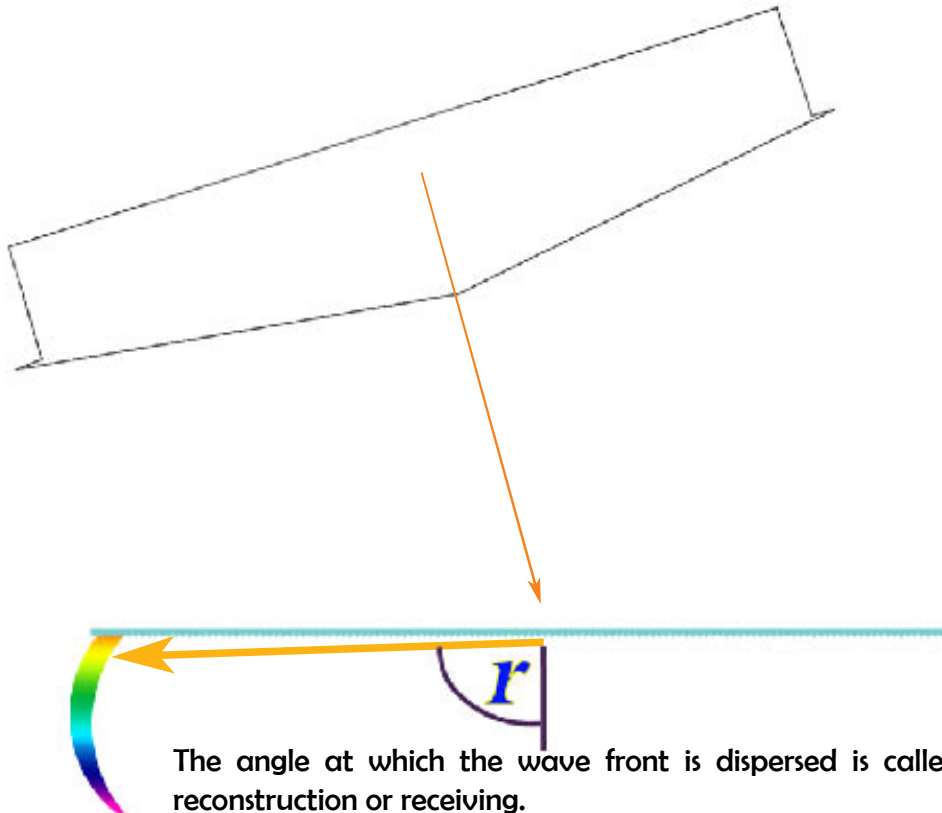

The angle at which the wave front is dispersed is called r for angle of reconstruction or receiving.

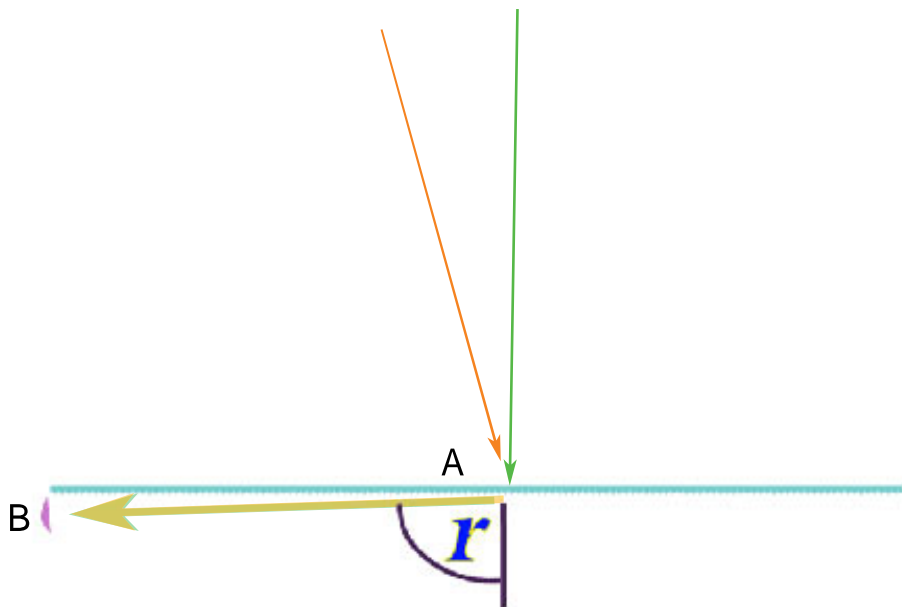

Multiple rays from objects at different angles of incidence can share a single angle of reconstruction.

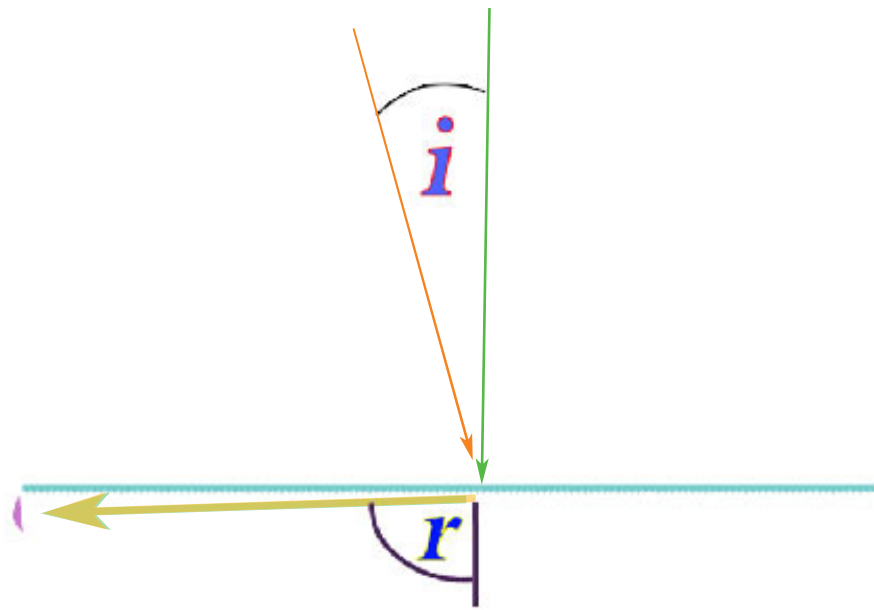

Rays incident upon the primary are subtended from the normal by angle i .

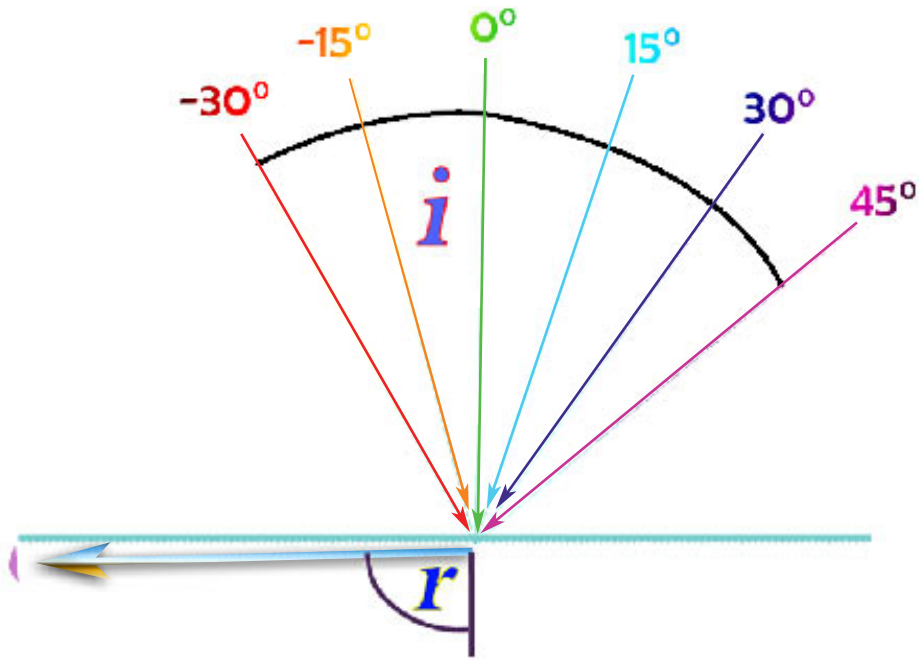

A wide arc of incident angles i can share a fixed angle of reconstruction r .

All rays follow the geometry of the Diffraction Equation which dictates that if the pitch p of the grating is fixed; the diffraction order n is set to one of its non-zero integer values; and the receiving angle r is invariant; then the angle of incidence i will select a wave length λ from the incident radiation.

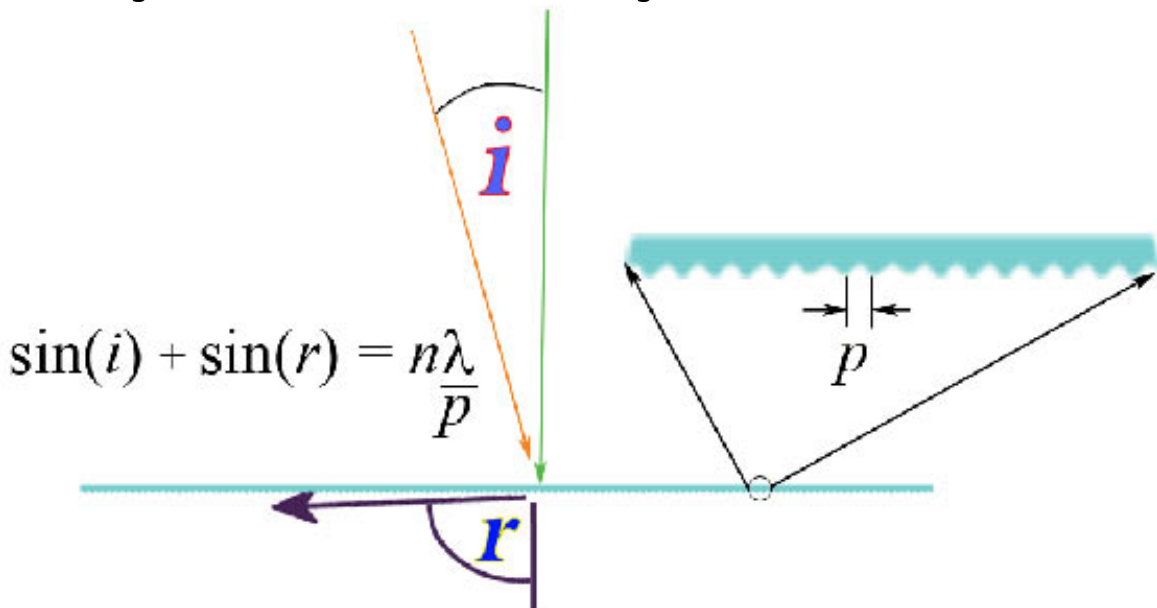

The Diffraction Equation

One way to conceptualize a Dittoscope is to think of a typical spectroscopy-capable telescope aimed at a grating flat on the ground. Now the primary mirror is a secondary, but its spectrometer is unchanged. It has a grating and a slit.

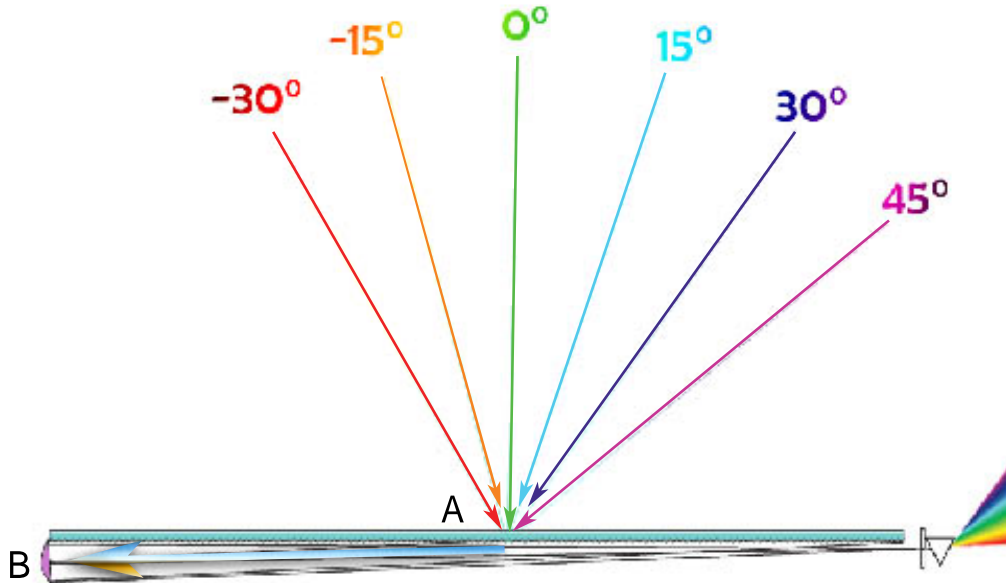

The secondary spectrometer eliminates the overlapping spectra from the primary objective grating that hobbled the original objective grating telescope

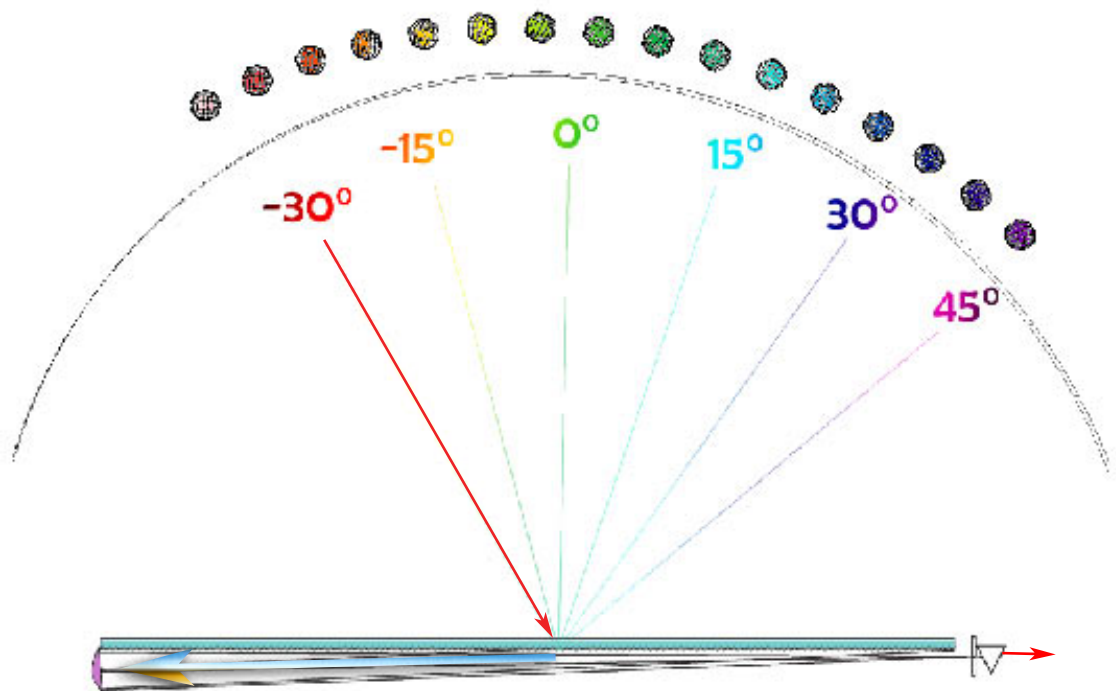

Instead of overlapping spectra, each object is imaged at a single wave length at any unique angle of incidence.

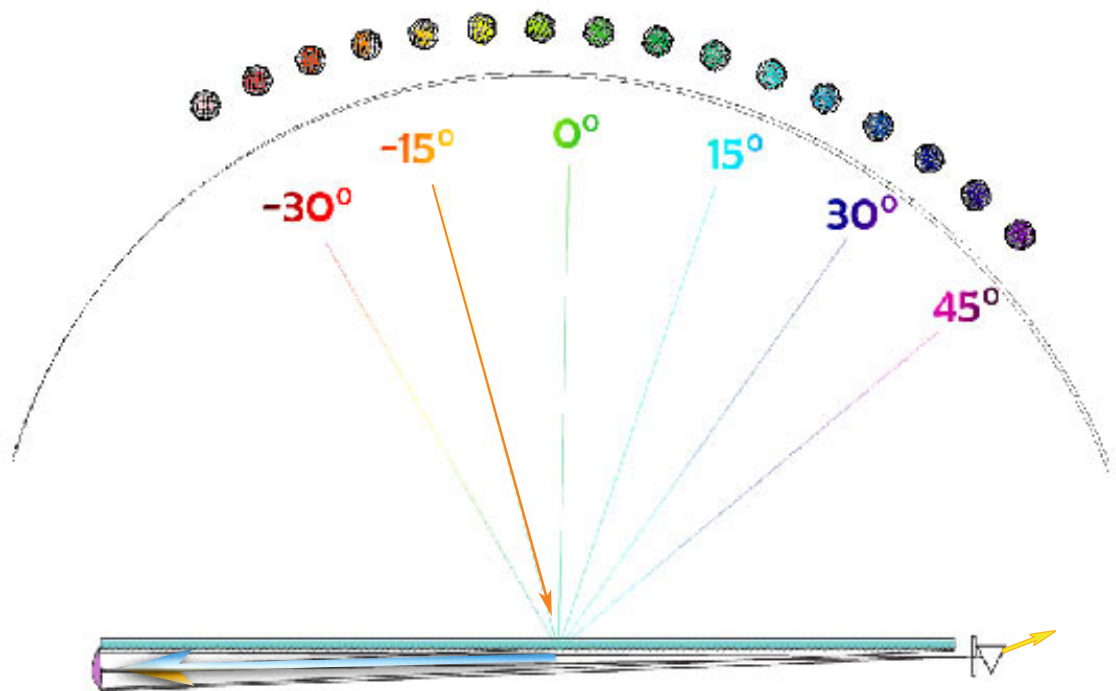

All stars in a line of right ascension that are within the free spectral range of the primary objective grating are recorded simultaneously, each at a unique wavelength.

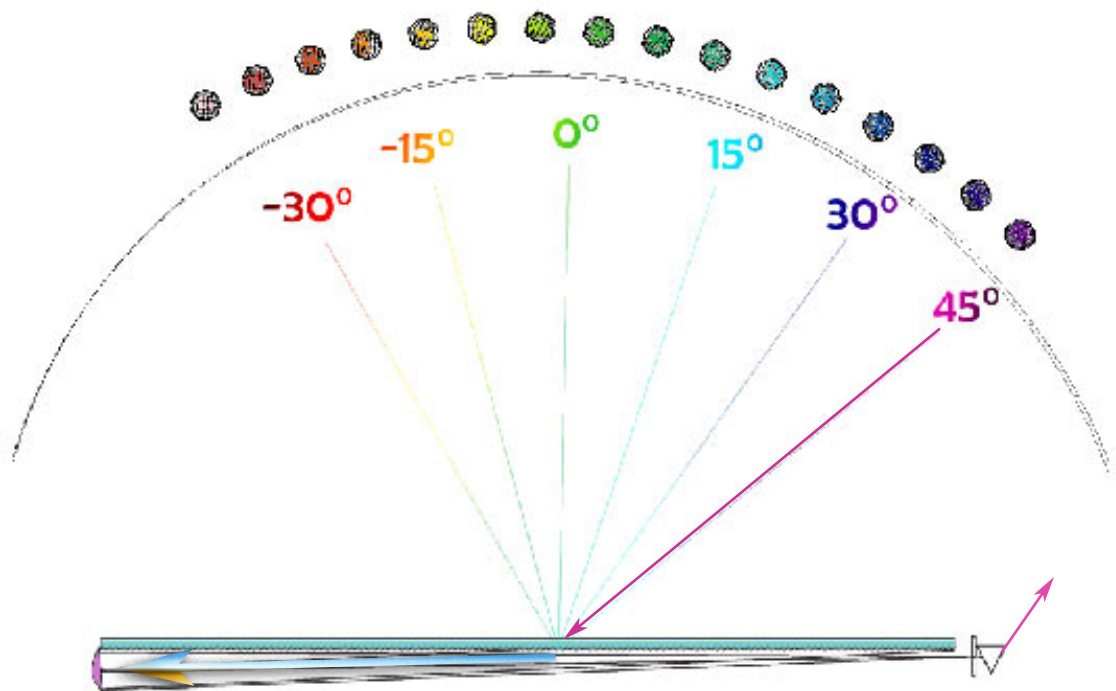

In a terrestrial setting, a Dittoscope can operate with no moving parts. Well, there is a moving part - the rotating earth, but once the telescope is positioned, it can remain stationary. To do this the instrument would be oriented along lines of latitude, east-west.

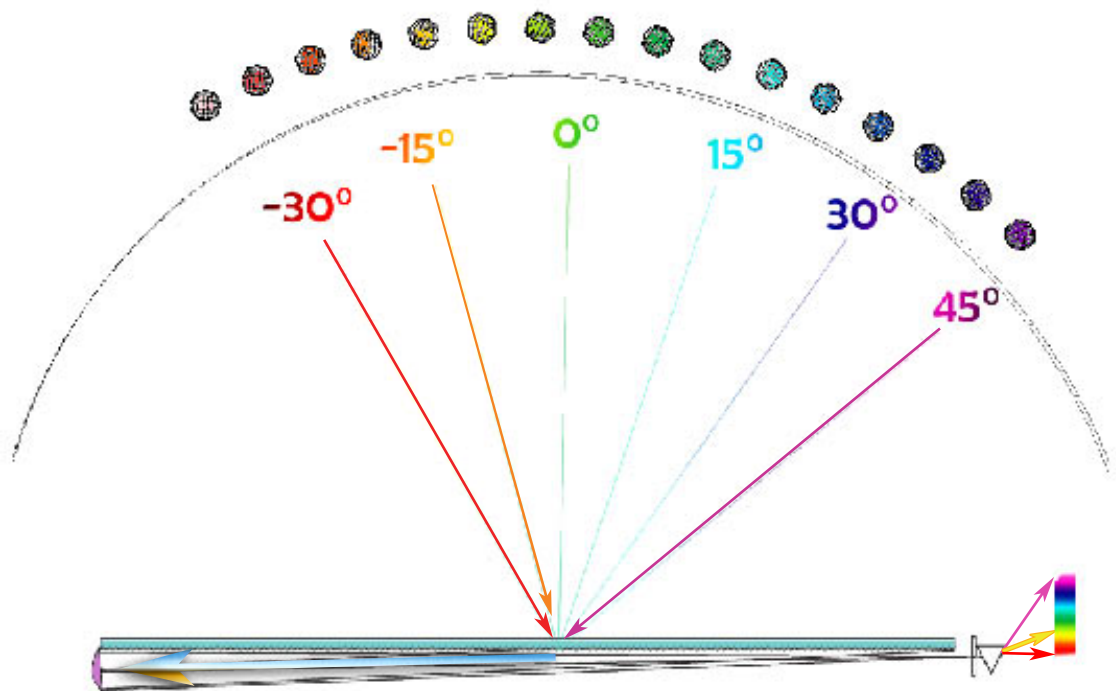

The precession of objects in the night sky causes their incident angles to rotate. For any incident angle there is a corresponding wavelength, so an entire spectrogram can be assembled over the course of a night.



Now it
can be
said that the
best primary
objective for this
astronomical telescope is
the one with the greatest
chromatic aberration. The
inverted axiom suggests objective
gratings of very fine pitch - sub
wavelength over much of the spectrum.
These are gratings that operate in one of the
first-orders and have the widest possible free
spectral range.

Ross
over
Galileo, tell
Isaac Newton the news.

600 nm pitch plane grating 87 degrees grazing exodus

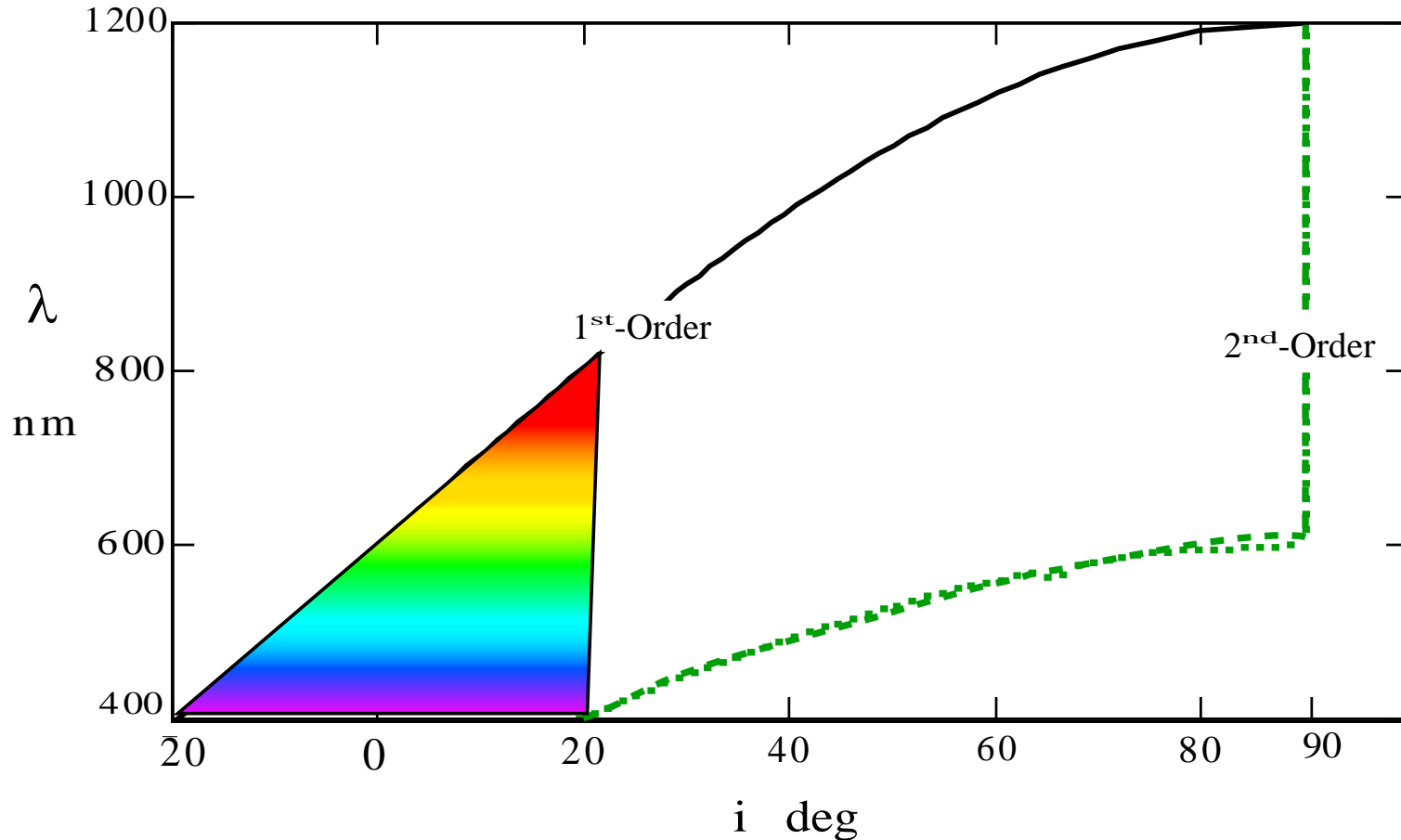

Free Spectral Range

Extraordinarily, the greatest magnifications also deliver the widest the fields-of-view, with the greatest dispersion, a 40 degree arc. This puts millions of stars within view simultaneously, each at a unique wave length at any particular instant. Since the output of the telescope is spectrographic, multiple object spectrometer problems are no longer the vexing issue of conventional telescoping. Every object has its spectrum taken. Stars do not need to be localized in advance of taking their spectra. There are spectral signatures for all objects in sight from first light.

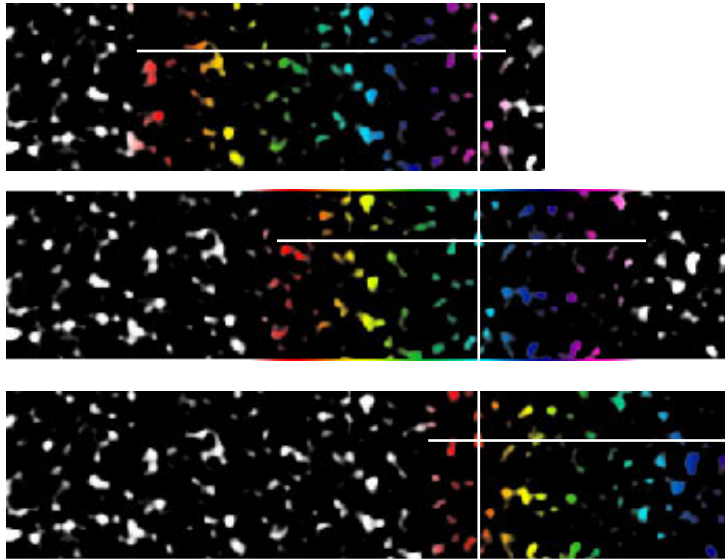

Three samples of one star

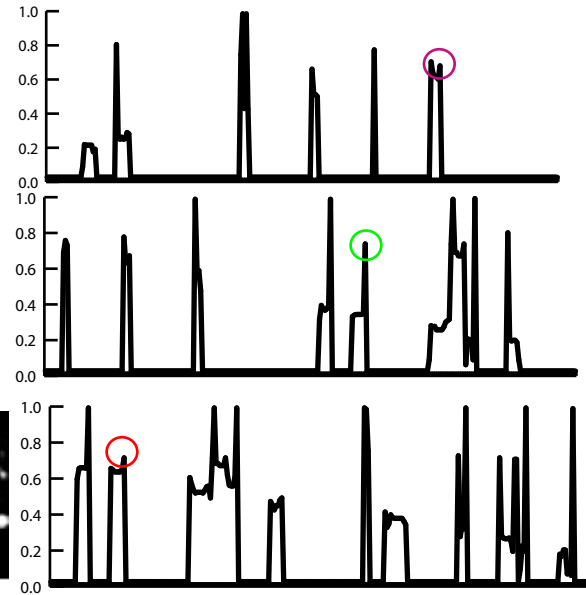

Three frames in the data parade

Data Reduction by Temporal Spectroscopy

Data reduction of an instantaneous spectrogram requires the correlation of wave length to sidereal time and thereafter angle of incidence. The entire spectrogram of a single object is taken from a series of snapshots as that object transits through the free spectral range. The complete spectra of all objects that precess through the entire free spectral range can be obtained, and partial spectra are available for those that are partially extinguished by daytime or cloud cover.

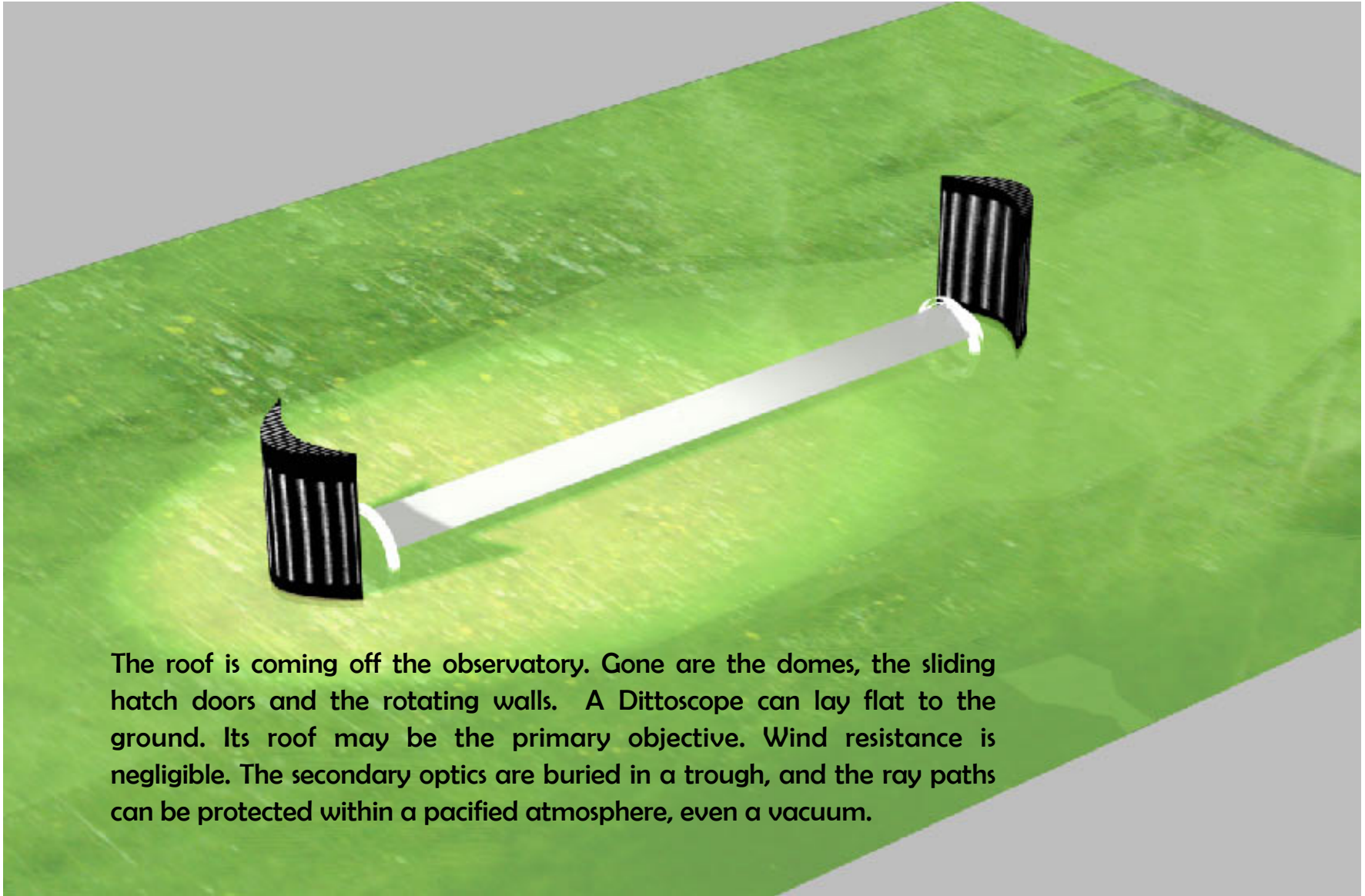

The roof is coming off the observatory. Gone are the domes, the sliding hatch doors and the rotating walls. A Dittoscope can lay flat to the ground. Its roof may be the primary objective. Wind resistance is negligible. The secondary optics are buried in a trough, and the ray paths can be protected within a pacified atmosphere, even a vacuum.

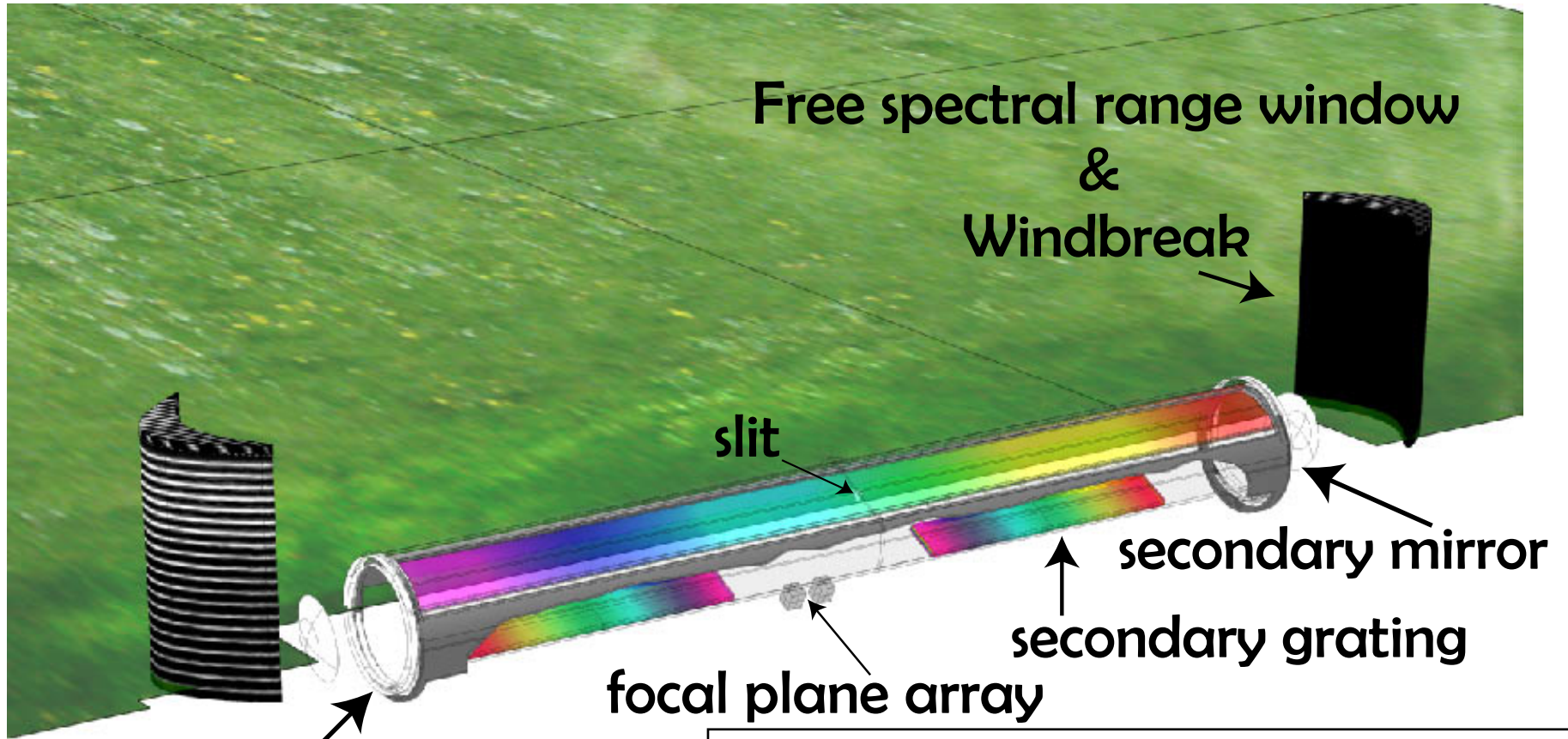

latitude axis of rotation

Free spectral range window
&
Windbreak

secondary mirror

secondary grating

focal plane array

Unlike co-axial instruments that have intra-optic spiders to hold components and folding mirrors to collapse the telescope to shorter lengths, the unique flat posture of the Dittoscope allows for the ray path to avoid artifacts caused by these occluding members. Long focal length secondary mirrors are allowable without folding. One possibility is a focal length $\frac{1}{2}$ grating length. That would place the slit of the secondary spectrometer in the middle of the primary objective grating.

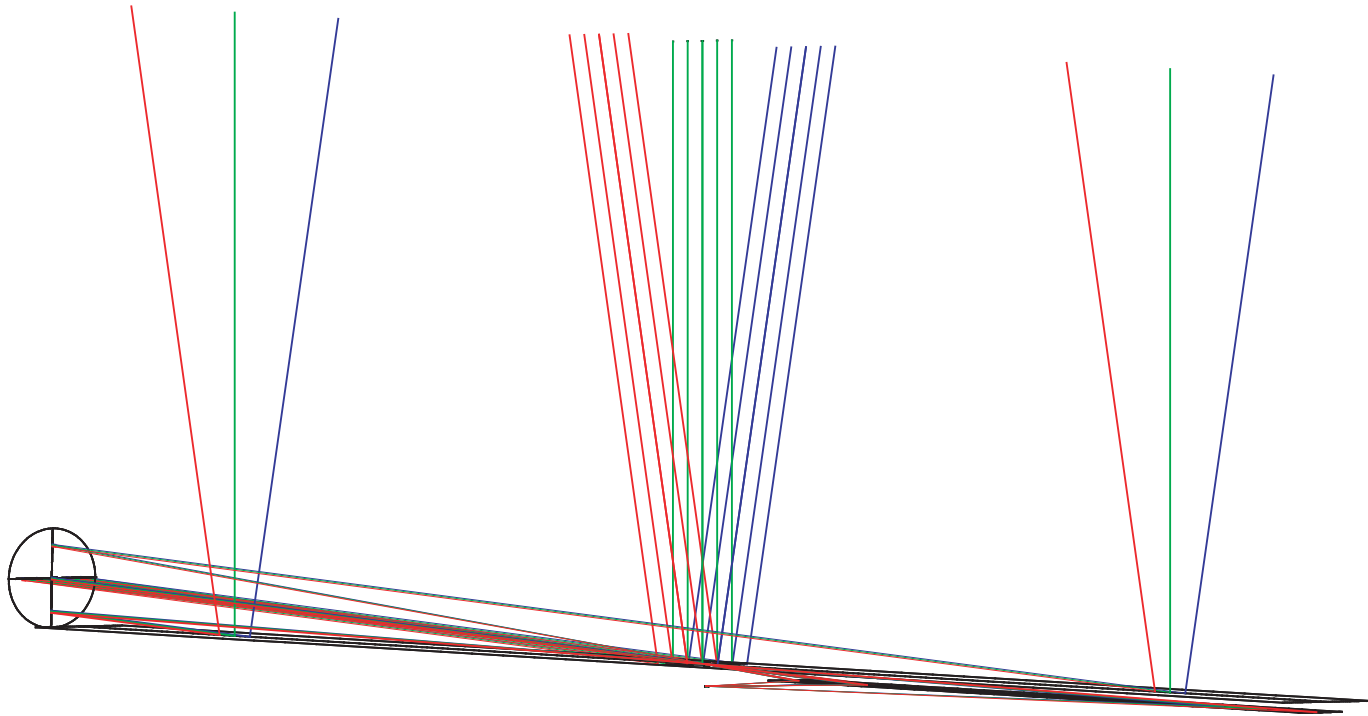

3D LAYOUT

DITTOSCOPE

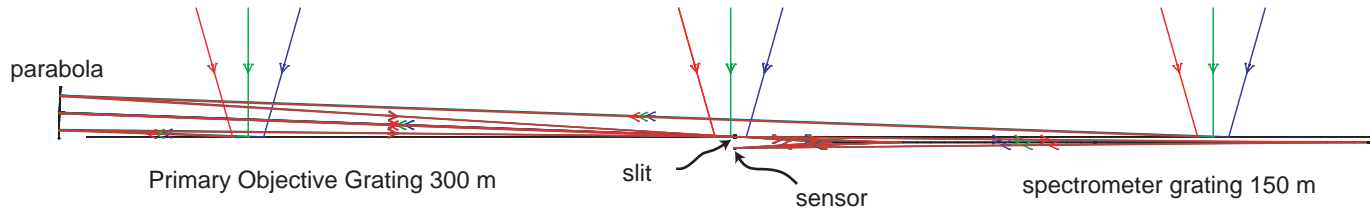



Segmentation

Laser interferometric alignment by day
Set for the night and lock down

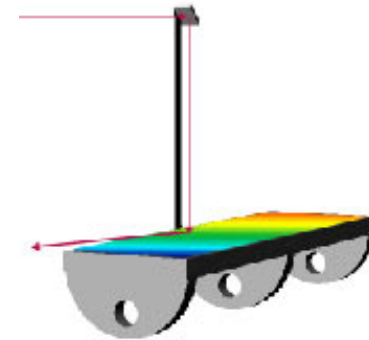

The grating can be segmented. Modular construction allows for use during incremental construction. Modules can be aligned by laser interferometry. This type of structure has utility for terrestrial settings.

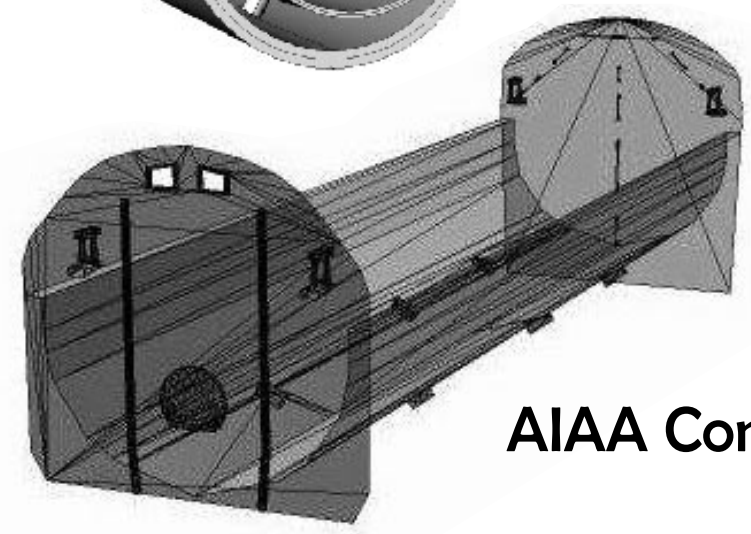
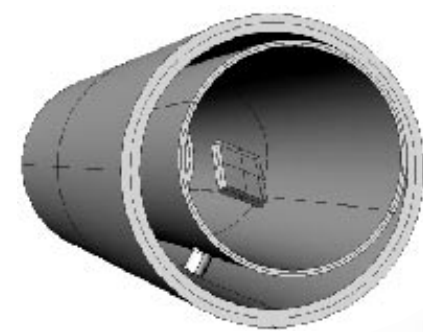
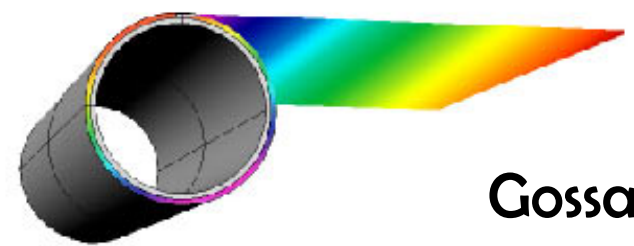
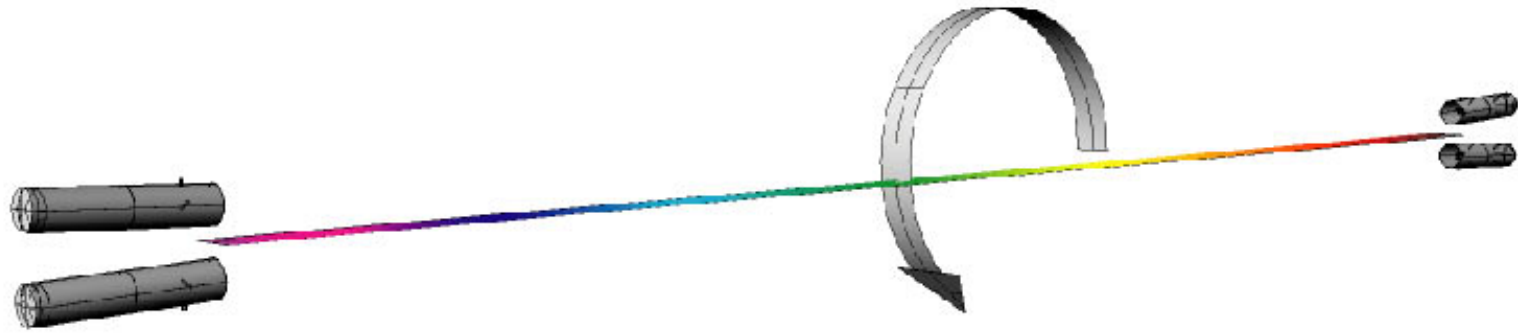

Gossamer Membrane deployed from Shuttle delivery bay or stowage in a cylinder fairing

The flat grating has a ribbon shape and lends itself to deployment as a gossamer membrane. This type of structure has utility for space telescopes. Storage during insertion is as a roll which can be unfurled in orbit and attached to a stretcher. Membranes want to be flat. Obtaining a useful optical figure presents far fewer technical problems than reflection primaries.

AIAA Conference paper forthcoming in April

Gratings are different. As grazing approaches exodus, tolerances improve.



The Dittoscope primary objective grating is nominally flat, save for its periodic grating micro-structure at the scale of the wave length of light. Constructive interference from billions of grating grooves can produce highly refined spectral spreads. The theoretical resolving power of a kilometer scale diffraction grating is 1/100,000 of an Angstrom. If the performance target is to achieve 1/10 of an Angstrom over the visible spectrum, the error budget for flatness and phase error is 10,000 to one, so this concept is extremely robust. The grating can be made from float glass that has a precise figure only in the shorter of its two dimensions where the surface is essentially a plane mirror.

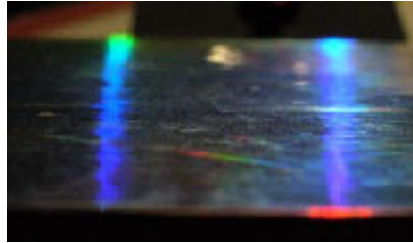

Grating flatness tolerance?



Gratings are different.



Fabrication of gratings is no longer a matter of mechanical ruling. The master grating can be made as a simple Fraunhofer hologram, that is, the interference of two coherent plane waves. Copies can be replicated using released epoxy or even by mass replication embossing from a cylindrical master called a shim.



If one or both of the coherent interfering waves during fabrication is a point source the product is a grating with curved rules. The holography laboratory that generates the plates is reconfigured for the exposure of each unique segment of a larger structure. It might be possible to use such Fresnel holograms without any secondary mirror. The entire apparatus would be based on dispersion principles. Lateral dispersion requires a more complex secondary spectrometer.

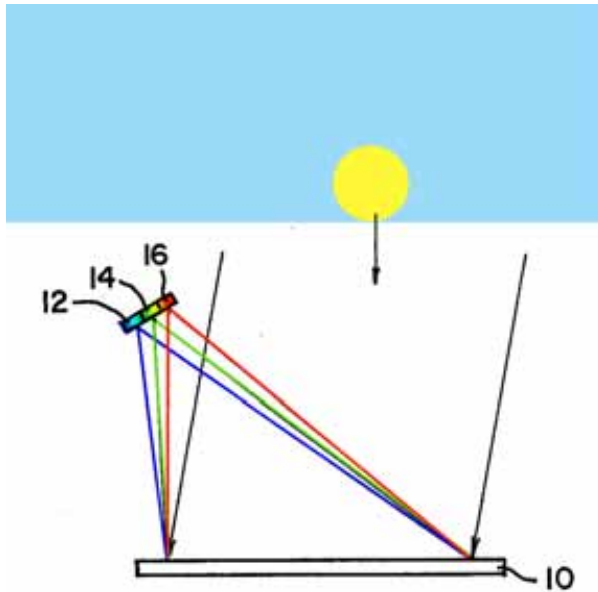

McGrew solar collector

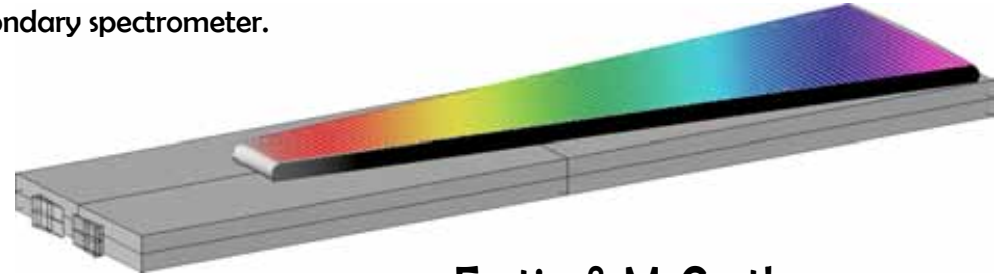

Fortin & McCarthy
holographic spectrometer

These gratings have variable pitch and parabolic curved rules

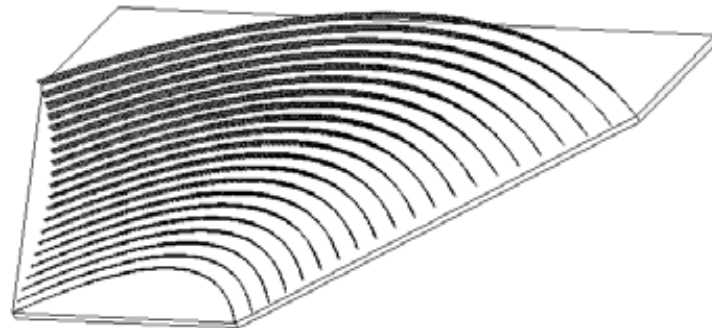

I have proposed a lunar observatory where collected flux is trapped in an evanescent wave inside the substrate of the primary objective and is tunneled to a complex secondary spectrometer where it is disambiguated in two dimensions. The design principles are drawn from recent innovations in fiber optic telecommunications where gradient indexed fibers channel multiple wavelengths to highly resonant Bragg grating filters. The principles could be extended to spectrometers. The lunar observatory I have proposed sits on the lunar equator. It can be constructed and serviced as modules. It has no moving parts. It can return detailed spectra for all objects along the zenith. Its service life can be thought of in terms of decades. Set it and forget it, you can integrate for improbable durations.



Equatorial Lunar Observatory

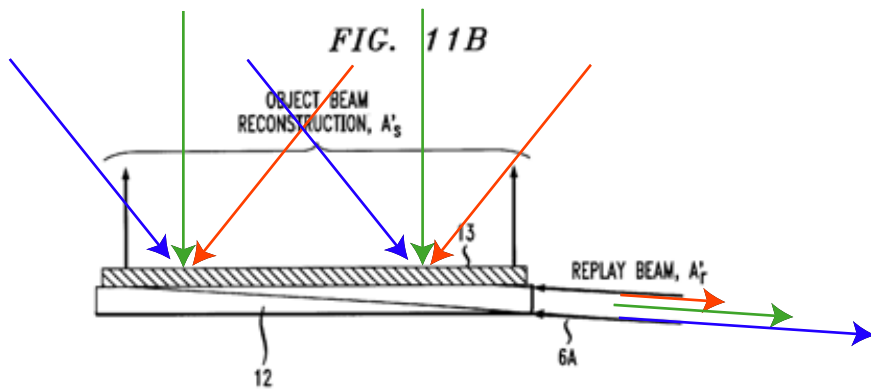

Edge-lit hologram played in reverse

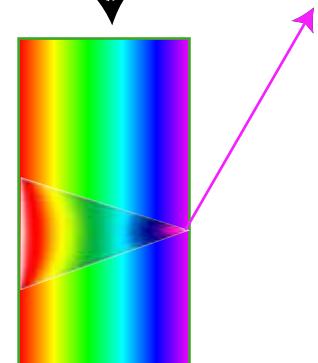

wave division multiplexed Bragg grating

Wavelength resolution as a function of dwell time

Units $\mu\text{m} = \text{mm} \cdot 10^{-3}$ $\text{nm} = \mu\text{m} \cdot 10^{-3}$ $\text{\AA} = \text{m} \cdot 10^{-10}$

diffraction order $n_1 := 1$ $q := 0..9$

pitch & wave length $p := 600 \cdot \text{nm}$ **Iterators** $j := 0..600$

angle of grazing exodus $r := 89 \cdot \text{deg}$ $k := 0..23$

night time $t_j := (j - 300) \cdot \text{min}$

$i_j := \frac{t_j}{24 \cdot \text{hr}} \cdot 360 \cdot \text{deg}$

The Grating Equation $\sin(i) + \sin(r) = n \frac{\lambda}{p}$

at midnight we look at the zenith for k secs.

$\Delta t_k := k \cdot \text{sec}$

resolved wave lengths $\Delta \lambda_k := p \cdot \left[\frac{\sin\left(\frac{\Delta t_k}{24 \cdot \text{hr}} \cdot 360 \cdot \text{deg}\right) + \sin(r)}{n_1} - \frac{\sin(r)}{n_1} \right]$

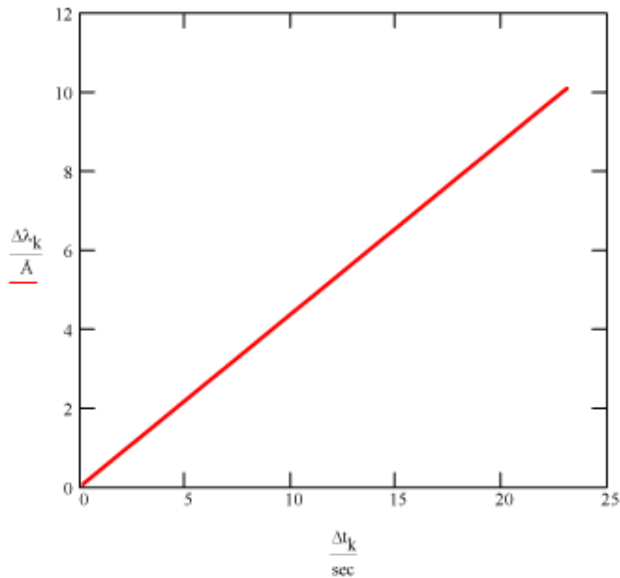

at the zenith at midnight (worst case scenario for a Dittoscope), we can resolve 1 Angstrom in 2.3 seconds and 1 nm in 23 seconds

Yet, it turns out that integration time is the Achilles heel of a Dittoscope, a little flaw that makes a great idea vulnerable to the arrows of its critics. If targets are transiting the Great Circle where precession is most rapid, then on earth there are only 2.3 seconds available per Angstrom per target per night. Even on the moon, that integration period is only 28 times longer, barely a minute. A lunar observatory will only see a target's flux at Angstrom resolution for a total of 120 minutes in an entire decade.

Angle of declination

$\beta_q := (10 \cdot q) \cdot \text{deg}$

$\alpha_k := \frac{\Delta t_k}{24 \cdot \text{hr}} \cdot 360 \cdot \text{deg}$

$i_{(k,q)} := \alpha_k \cdot \cos(\beta_q)$

$i_{0,0} = 0$
deg

β_q deg
0
10
20
30
40
50
60
70
80
90

$\Delta \lambda_{k,q} := p \cdot \left[\frac{\sin(i_{k,q}) + \sin(r)}{n_1} - \frac{\sin(r)}{n_1} \right]$

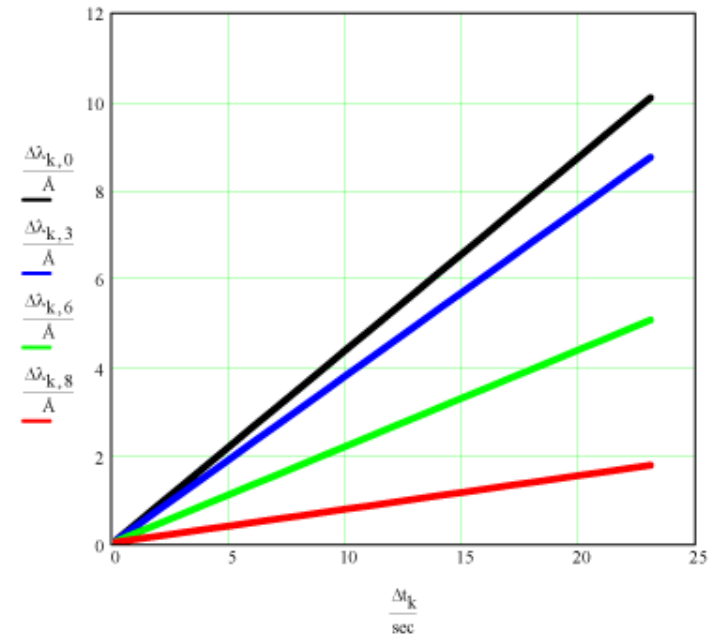

Comparison of dwell times and wave length resolution at various angles of declination. The top solid line is at the Great Circle. Lines below are respectively at 30, 60 & 80 deg.

Correlation of angular resolution with spectral resolution

Grating pitch $p := 600 \cdot \text{nm}$ Order $n = 1$

Spectral resolution $R := 1.5 \cdot \text{\AA}$ iterators $j := 0 \dots 600$
 $k := 0 \dots 90$

$$\lambda_{1,j,k} := \lambda_{j,k} + 1 \cdot R$$

$$\Delta\lambda_{j,k} := \lambda_{1,j,k} - \lambda_{j,k}$$

$$\sin(i) + \sin(r) = n \cdot \frac{\lambda}{p}$$

$$\Delta i_{j,k} := \text{asin}\left(n \cdot \frac{\lambda_{1,j,k}}{p} - \sin(r)\right) - \text{asin}\left(n \cdot \frac{\lambda_{j,k}}{p} - \sin(r)\right)$$

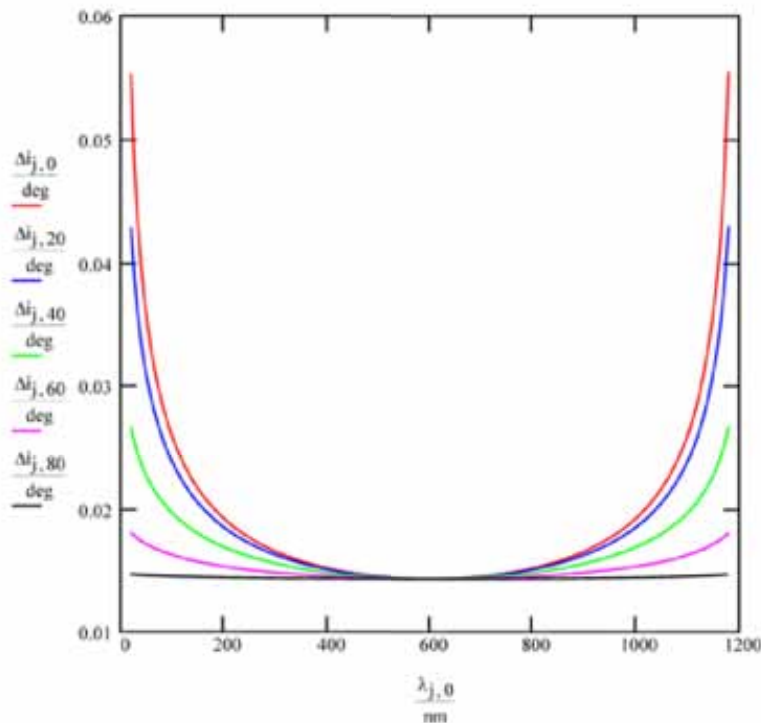

Moreover, since resolving power and angular resolution are bound together, at least when the Dittoscope's pose is static, increasing integration time by lowering resolving power runs the risk that objects will overlap. At the visible wavelengths into the near infrared, it can be said that an Angstrom provides only 10 arc seconds of resolving power. Whatever way you slice it, there is going to be a tradeoff between integration time, spectral resolving power and angular resolution. It's a triage decision, and against the best large telescope, the Dittoscope is not superior - at least for a single target.

That limitation being said, the analysis does invite experimentation to corroborate the prediction.

"star" 5 m from "Dittoscope"

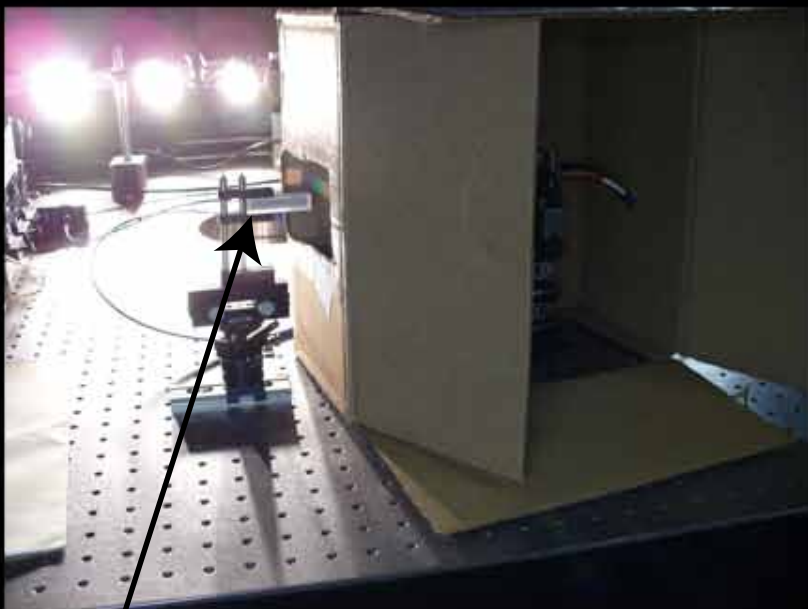

2 inch primary objective grating

We built a Dittoscope with a two inch primary objective and tested the prediction with a "star" that was 5 meters from the primary. Readings were taken at the zenith which corresponded to 555 nm for our 1800 line per mm grating. While our little telescope performed according to prediction, the lab work is just starting. We take courage in the fact that Newton's first telescope sported a primary objective that was a mere 1.3 inches in diameter. Ours is two inches! However, it's a very long way from seeing stars.

green

inches	radians	deg	nm	$\Delta\lambda$	deg	nm	$\Delta\lambda$	
0.00	0.0002632	0.0150778	552.62			555.51		
0.05	0.0002632	0.0150778	552.51	0.11		555.49	0.02	discarded
0.10	0.0002632	0.0150778	552.36	0.15	0.015078	555.35	0.14	
0.15	0.0002632	0.0150778	552.23	0.13	0.015078	555.21	0.14	
0.20	0.0002632	0.0150778	552.08	0.15	0.015078	555.09	0.12	
0.25	0.0002632	0.0150778	551.94	0.14	0.015078	554.95	0.14	
0.30	0.0002632	0.0150778	551.79	0.15	0.015078	554.81	0.14	
0.35	0.0002632	0.0150778	551.64	0.15	0.015078	554.69	0.12	
0.40	0.0002632	0.0150778	551.49	0.15	0.015078	554.56	0.13	
0.45	0.0002632	0.0150778	551.35	0.14	0.015078	554.42	0.14	
0.50	0.0002632	0.0150778	551.21	0.14	0.015078	554.28	0.14	
0.55	0.0002632	0.0150778	551.06	0.15	0.015078	554.15	0.13	
0.60	0.0002632	0.0150778	550.91	0.15	0.015078	554.01	0.14	
0.65	0.0002632	0.0150778	550.76	0.15	0.015078	553.87	0.14	
0.70	0.0002632	0.0150778	550.61	0.15	0.015078	553.74	0.13	
0.75	0.0002632	0.0150778	550.48	0.13	0.015078	553.6	0.14	
0.80	0.0002632	0.0150778	550.32	0.16	0.015078	553.47	0.13	
0.85	0.0002632	0.0150778	550.18	0.14	0.015078	553.33	0.14	
0.90	0.0002632	0.0150778	550.03	0.15				
0.95	0.0002632	0.0150778	549.9	0.13				
1.00	0.0002632	0.0150778	549.76	0.14				
Total angular field		0.2864789			0.226168			
Average change in nm				0.144737			0.135	
total range in nm			2.44			2.18		

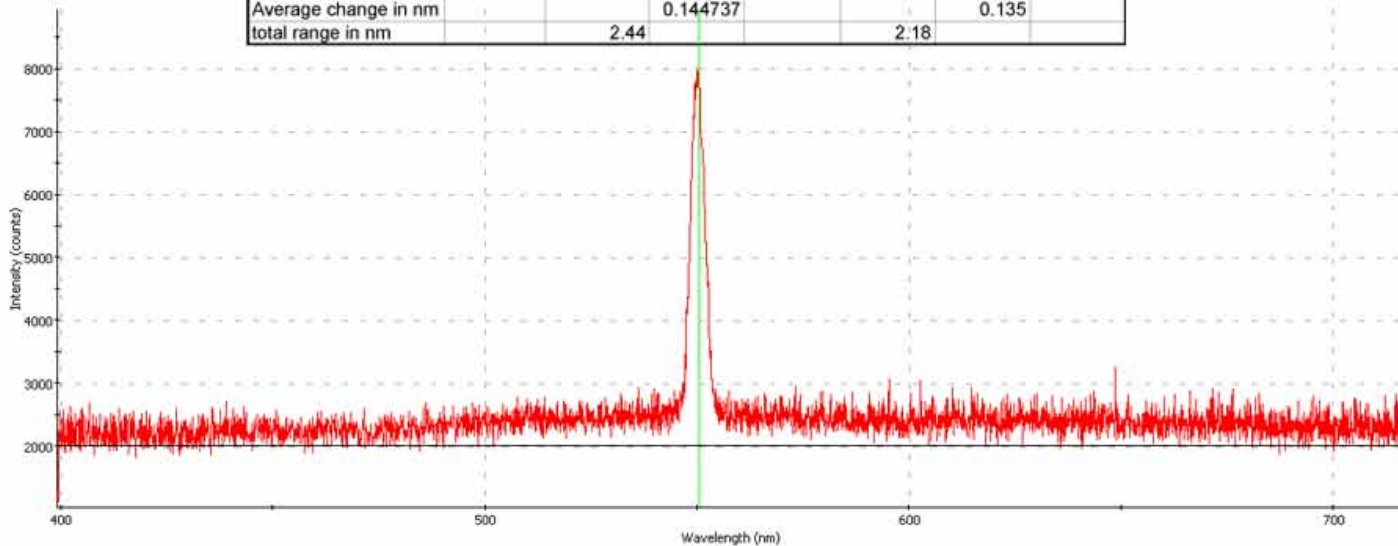

As predicted, a full bandwidth target was detected as a solitary spike at the secondary spectrometer. Here at the zenith, the centroid lands at a wave length equal to the pitch of the grating. The chart shows incremental readings that match angular resolution with spectral resolving power. A change of 0.015 degrees is locked to a shift of 1.5 Angstroms. This too is as predicted. We have a Dittoscope!

89 deg grazing exodus, 100 m primary, 1.4 m secondary

TABLE 1
SENSITIVITY

item	value
atmosphere throughput	0.90
grating efficiency	0.10
collector reflectance (2 mirrors)	0.96
field slicer efficiency	0.90
spectrograph throughput	0.83
detector quantum efficiency	0.80
Total throughput	0.052
Observing wavelength (nanometers)	650
Spectral resolution $\frac{\lambda}{\Delta\lambda}$	10^{-5}
collector area (square meters)	1
Integration time seconds (1 degree field)	240
Stellar magnitude	20
photons per bandpass	350

Whatever the weakness of the integration time, we have determined that the instrument works on fundamentals. Achilles may have had a weakness too, but he took out a lot of Trojans first. A model of the Dittoscope worked out by Dave Mozurkewich which had a 1.4 meter secondary mirror and an R=100,000 secondary spectrometer was capable of taking spectra of Magnitude 20 stars. He did make a favorable forecast for one parameter, the integration time based on a 1 degree field-of-view in the secondary which led to an integration time of 240 seconds.

source Mozurkewich

Magnitude	Example	Stars / degree ²	1° x 90°	Stars to this magnitude
-1.42	Sirius			1
6.5	Yale catalog			6,500
10.5	Hipparchus cat.	3	270	110,000
12	3" scope	12	1,080	500,000
13	6" scope	25	2,250	1,000,000
14	10" scope	60	5,400	2,500,000
15.5		300	27,000	10,000,000
20.5		30,000	2,700,000	1,000,000,000
23	Best scope	300,000	27,000,000	10,000,000,000

source Monkhouse

1 million spectra per night at R = 100,000

0.2 deg field-of-view dwell time ~ 50 sec

Field Data

Type: Angle (Deg) Object Height Parax. Image Height Real Image Height

Field Normalization: Radial

Use	X-Field	Y-Field	Weight	VDX	VDY	VGX	VGY	VAN
<input checked="" type="checkbox"/>	1	0.005	15.5	1.0000	0.00000	0.00000	0.00000	0.00000
<input checked="" type="checkbox"/>	2	0.005	15.6	1.0000	0.00000	0.00000	0.00000	0.00000
<input checked="" type="checkbox"/>	3	0.005	15.7	1.0000	0.00000	0.00000	0.00000	0.00000
<input type="checkbox"/>	4	0	0	1.0000	0.00000	0.00000	0.00000	0.00000
<input type="checkbox"/>	5	0	15.5998	1.0000	0.00000	0.00000	0.00000	0.00000
<input type="checkbox"/>	6	0.005	-15.822	1.0000	0.00000	0.00000	0.00000	0.00000
<input type="checkbox"/>	7	-0.005	15.823	1.0000	0.00000	0.00000	0.00000	0.00000
<input type="checkbox"/>	8	-0.005	-15.822	1.0000	0.00000	0.00000	0.00000	0.00000
<input type="checkbox"/>	9	0	5e-005	1.0000	0.00000	0.00000	0.00000	0.00000
<input type="checkbox"/>	10	0	0.0001	1.0000	0.00000	0.00000	0.00000	0.00000
<input type="checkbox"/>	11	0	0	1.0000	0.00000	0.00000	0.00000	0.00000
<input type="checkbox"/>	12	0	0	1.0000	0.00000	0.00000	0.00000	0.00000

Buttons: OK, Cancel, Sort, Help, Set Vig, Clr Vig, Save, Load

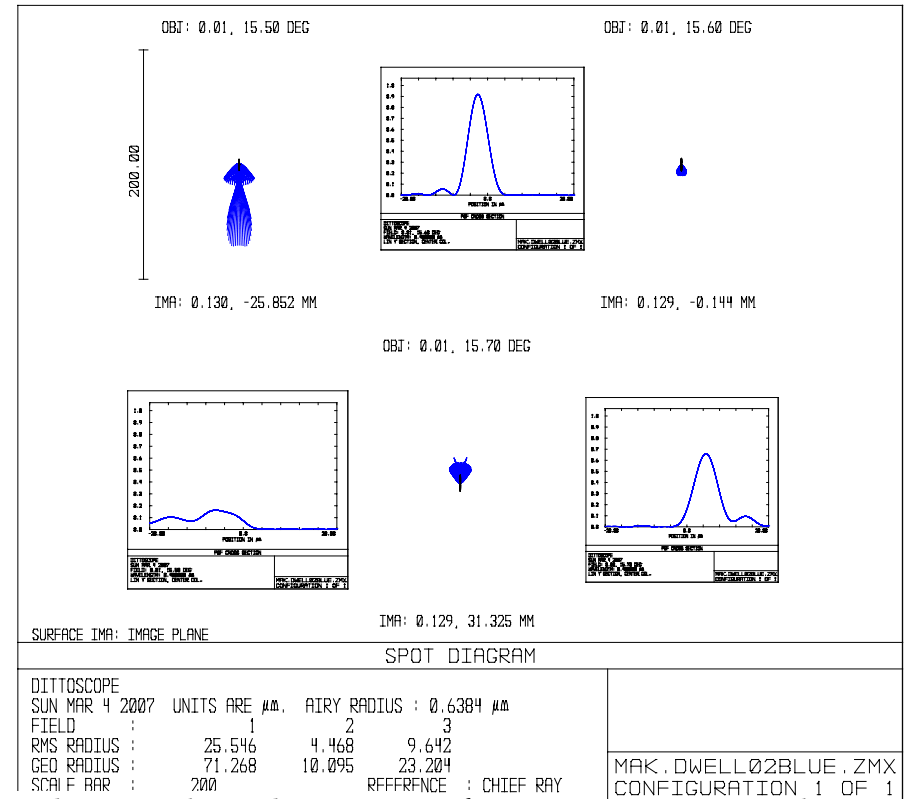

But while the Dittoscope's Achilles heel has some safety in these numbers, the question of integration time must be acknowledged and dealt with. One solution that seems to have potential is related to the field-of-view provided by the secondary. This doesn't apply to my proposed lunar observatory, but in terrestrial settings or space deployment, the acceptance angle of the secondary determines the number of ray paths at any one wave length for any one object. Here is a Zemax model of the alternative ray paths for one star at one wave length with the field of view of our Maksutov-Cassegrain. It might be able to integrate for 50 seconds at a grazing exodus angle of 85 degrees. Focal plane for fibers

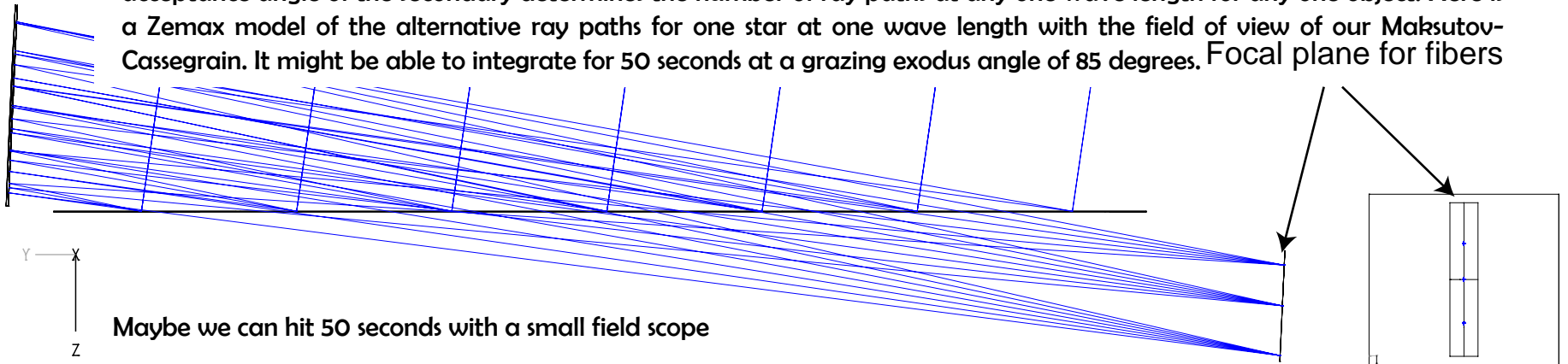

Efficiency vs Incident Angles for 280 nm sinusoidal groove
 632.8 nm wave length 1800 l/mm primary objective grating

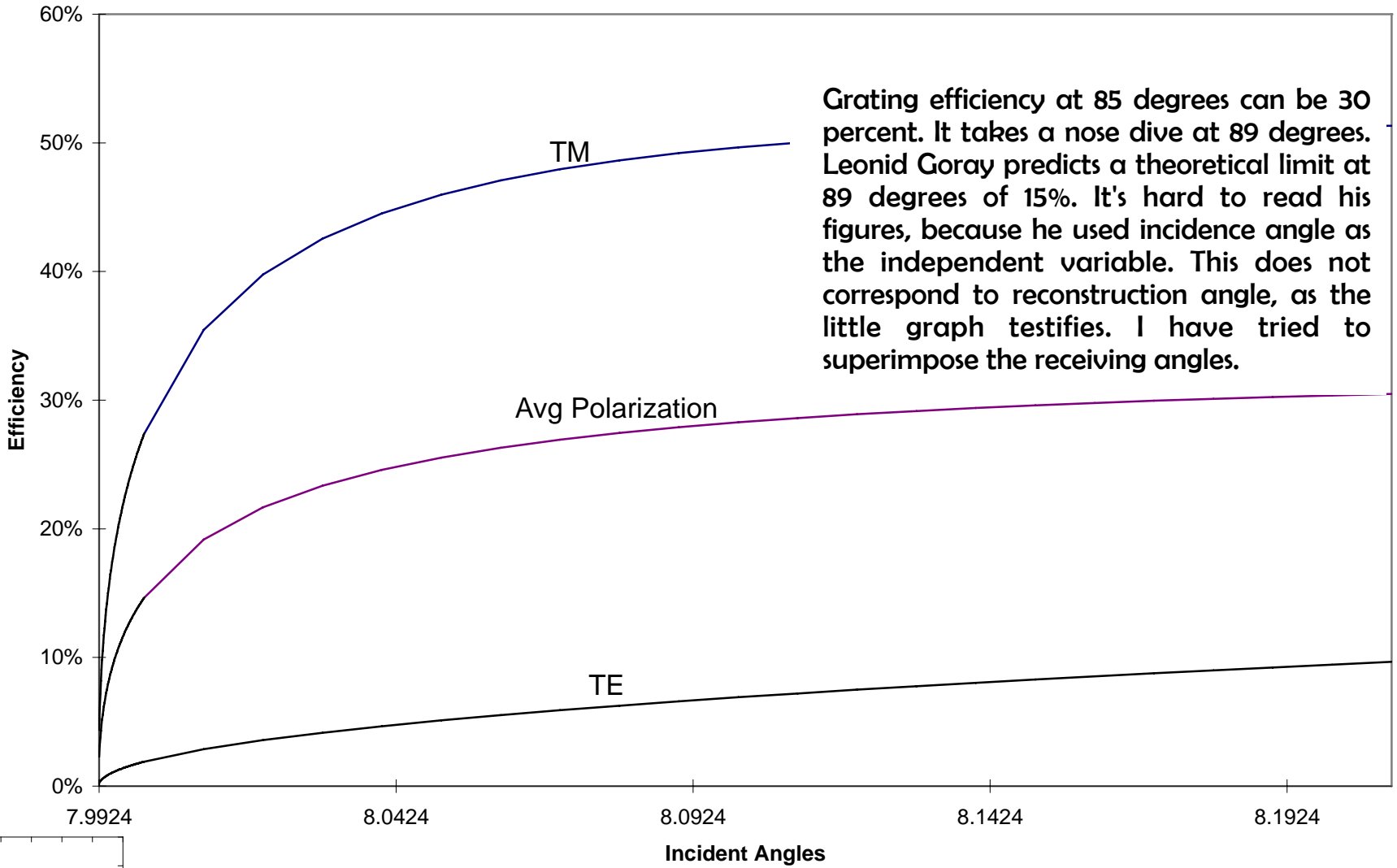

Grating efficiency at 85 degrees can be 30 percent. It takes a nose dive at 89 degrees. Leonid Goray predicts a theoretical limit at 89 degrees of 15%. It's hard to read his figures, because he used incidence angle as the independent variable. This does not correspond to reconstruction angle, as the little graph testifies. I have tried to superimpose the receiving angles.

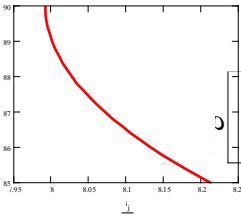

89.99	88.935	88.493	88.155	87.869	87.618	87.39	87.181	86.987	86.804	86.631	86.467	86.309	86.159	86.014	85.874	85.738	85.607	85.48	85.356	85.235	85.117	85.003	84.89	84.78	84.673
receiving angles																									

Dave Mosurkewich used a figure of 10% efficiency at 89 degrees grazing exodus for his throughput. We achieved these figures with our two inch grating. When I factored our actual readings with a real grating against the increase in length it affords as a function of grazing exodus angle, I came up with an overall benefit up to 89 degrees, despite the loss in efficiency.

Measured performance Optometrics grating

r in deg	efficiency
85	34%
86	31%
87	28%
88	22%
89	15%

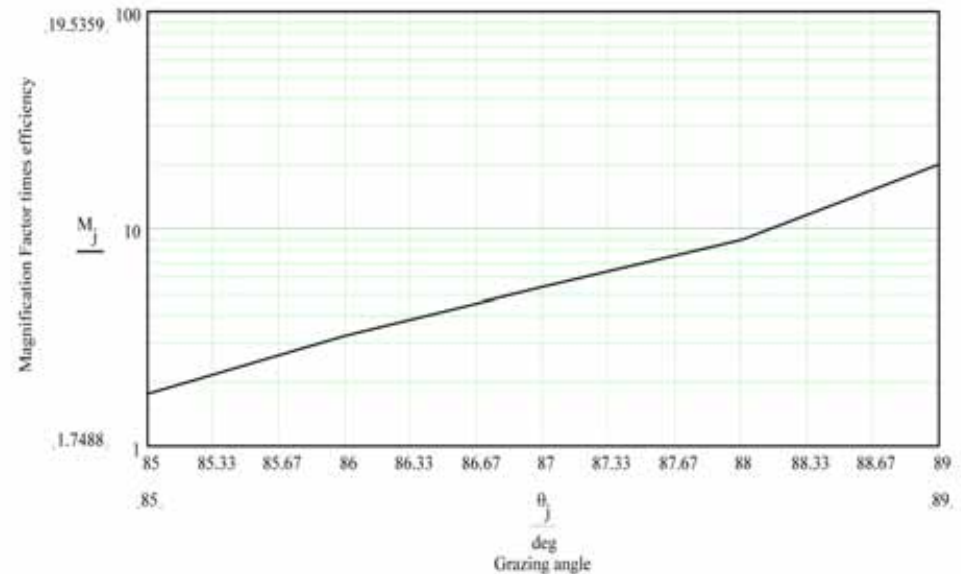
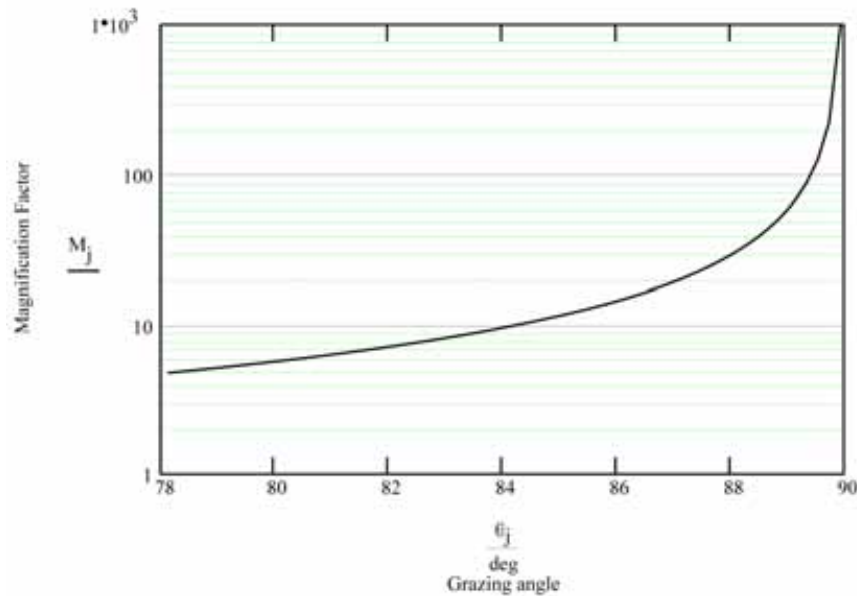

Magnification grows faster than efficiency is lost

So what is the problem with this idea? One problem is its very sensitivity. When the wavefront is magnified so much, the aberrations in the wave become apparent. Adaptive optics are not possible for large collectors. The grazing angle must be lowered to accommodate the sensitivity to wavefront distortions. It may be that grazing angle determines integration time too. The inflexible linking of three parameters: angular resolution, spectral resolving power and integration time must be balanced for any specific application. The quality of the primary is always a factor. Since it must operate as a mirror in one of the dimensions, the tolerance of the other dimension is not the limiting factor. To complete our preliminary investigation we have to put our finger on these:

- 1. What is the minimum size for the primary?**
- 2. What is the optimum angle for grazing exodus?**
- 3. What are the choices for the secondary?**
 - Pick a secondary spectrometer**
 - Design variations in the secondary mirror**
 - Investigate the idea of an entirely flat Dittoscope**
- 4. Is there an option for adaptive optics?**

Forthcoming: AIAA Conference Gossamer Spacecraft Forum
Phase I Report - Details on the empirical study
Phase II Proposal - The long road ahead