



A Simulation Based Investigation of High Latency Space Systems Operations

Paul Bielski
Zu Qun Li
Edwin Z. Crues
Michael Moore

NASA Exploration System Simulation (NExSyS)
NASA Johnson Space Center

NEEMO 21 Overview



- **Mission**

- An undersea mission to provide an analogue space mission
- Simulate a mission to Mars (15 minutes one-way communication delay)
- Coral sampling, nursery construction, geo sampling, and in-hab technology testing
 - One of the in-hab activities: Subsystem Simulation Study

- **Objectives at NEEMO 21**

- Use subsystem simulation to determine the effects of communication delay on the interaction between crew and MCC
- To understand how the crew handles malfunctions in the midst of their busy schedules
- To improve understanding of the NEEMO operational environment, mission scheduling, network configuration, and suitable hardware for future studies

- **Limitations**

- Crew only have minimal training on the subsystem simulation
- Crew always need to contact mission control when a system anomaly occurred
- Malfunctions were only inserted during crew free time
- One person was acting as both test conductor and mission control support for this study





Trick

- A NASA Open Source simulation framework for developing physics-based simulations
- Provides many features that include:
 - Real-time synchronization
 - Job scheduling
 - Runtime variable manipulation
 - Simulation event management
- Works with external software such as Input Device Framework (IDF) to provide human-in-the-loop simulation for crew training

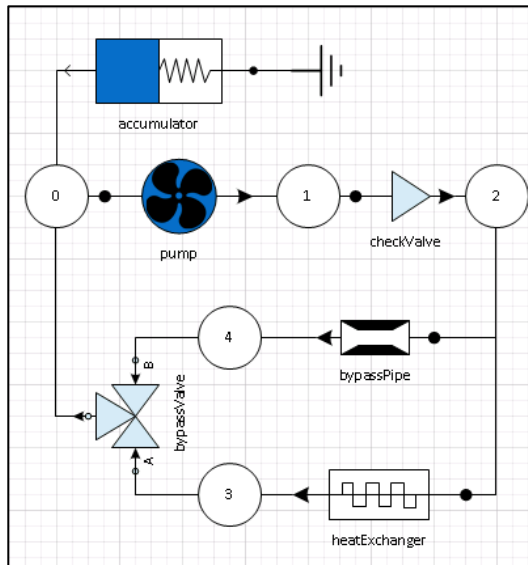

General Use Nodal Network Solver (GUNNS)

- Uses basic nodal analysis techniques to simulate
 - Fluidic systems
 - Electrical systems
 - Thermal systems
- Interconnects the three systems to simulate the real world interaction between them
- Used to develop medium-fidelity time based simulation for crew training and system performance analysis
- Provides a Visio based GUI, “GunnShow”, for developing the networks

Subsystem Simulation Models

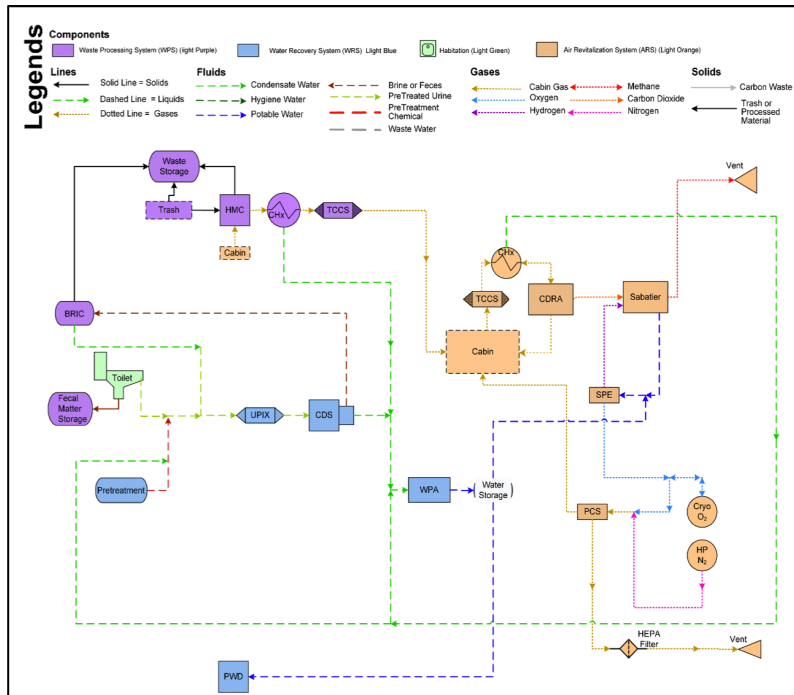
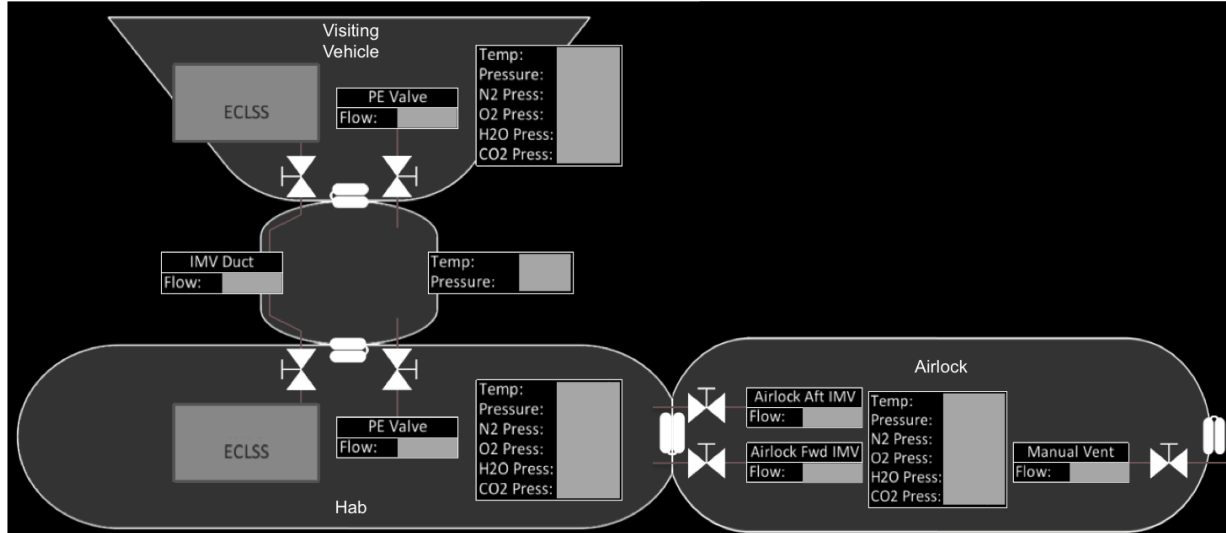

- **Environmental Control and Life Support System (ECLSS)**

- Air Revitalization System (ARS)
- Waste Processing System (WPS)
- Water Recovery System (WRS)

- **Thermal Control System**

- 1 internal thermal control loop
- 2 external thermal control loops

- **Electrical Power System**

- Models of solar array, solar array regulator, battery, and power distribution units (PDU)

Simulation Test Architecture

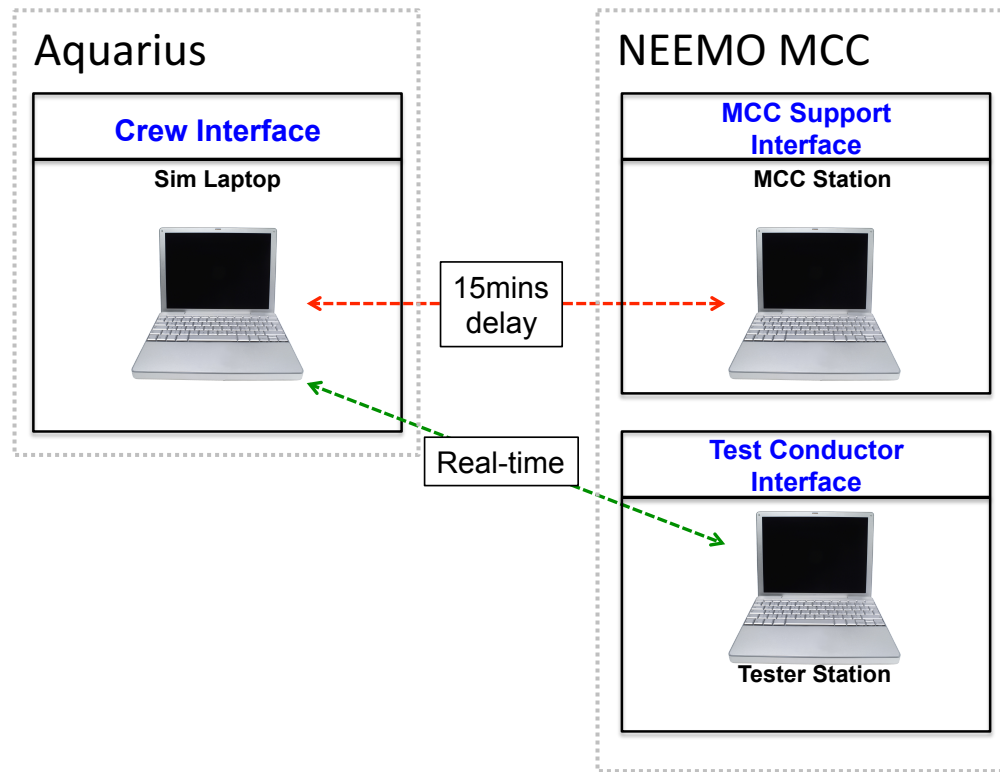

- Simulation laptop is located in the undersea habitat (Aquarius)
- There are 15 minutes of communication delay between the habitat and MCC
- Test conductor has access to real-time simulation data and mission communication for observation

Simulation Interfaces: Crew vs. MCC Display



Crew Display

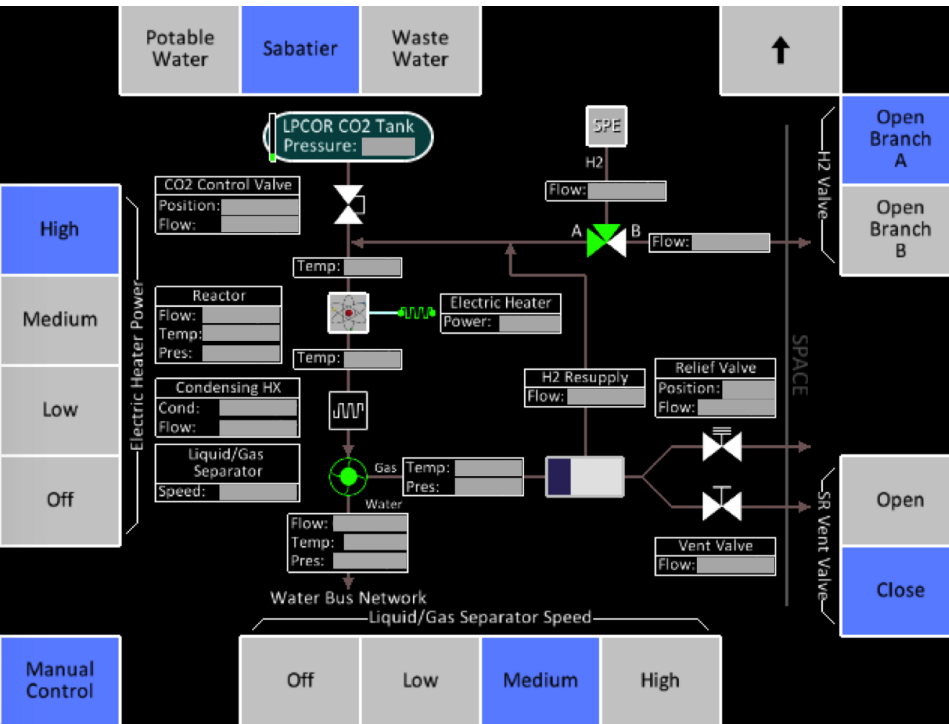

MCC Support Display

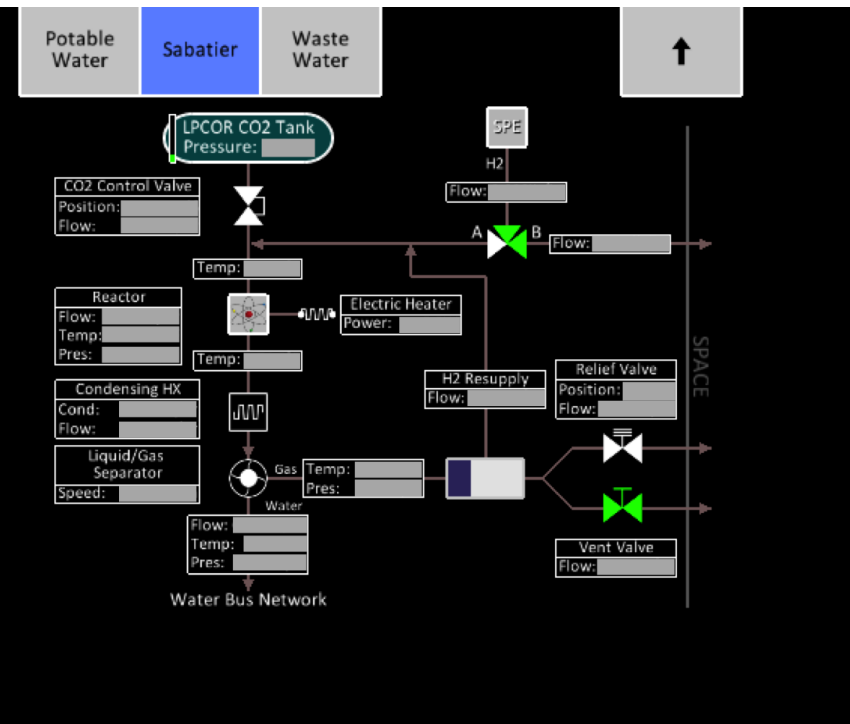

Crew

- Real-time simulation display with full nominal control of the system

MCC

- Delayed simulation display without any control of the system

Simulation Interfaces: Test Conductor Display



Test Conductor Display

Trick View (runtime data manipulation tool)

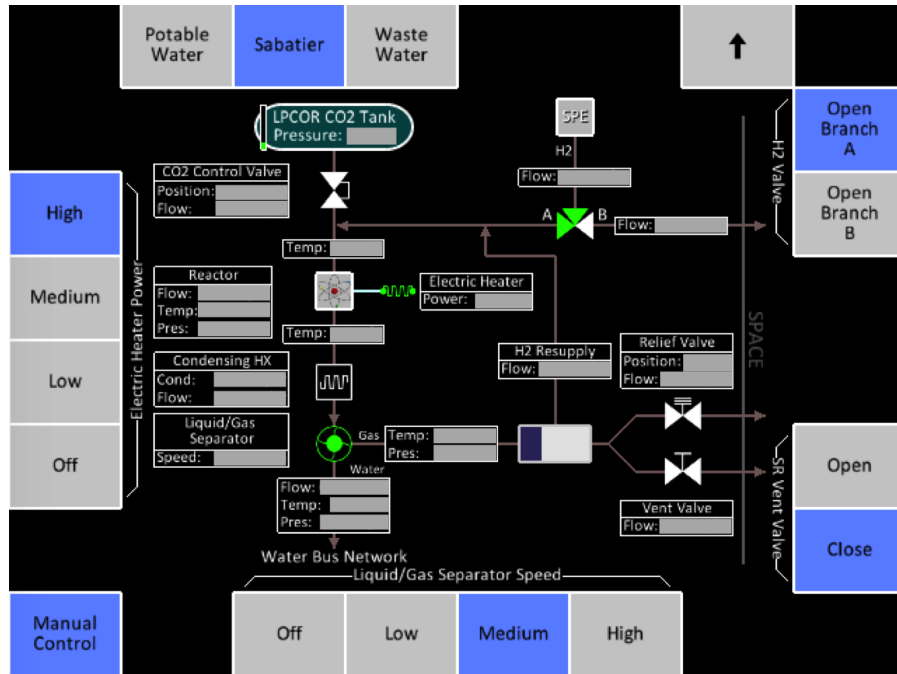

Variable	Value	Units	Format
<Trick Variables>			
<Dynamic Allocations>			
CTH			
atcs			
audio_warning			
eclass			
eps			
hs			
initbus			
jeod_sys			
jeod_time			
matcs_fsw_mtv_sim_bus			
matcs_fsw_mtv_sim_bus			
matcs_hab1_mtv_sim_bu			
matcs_hab1_mtv_sim_bu			
meclss_mtv_sim_bus_EC			
meclss_mtv_sim_bus_EC			
meclss_mtv_sim_bus_INI			
meps_elect_mtv_sim_bu			
meps_elect_mtv_sim_bu			
meps_mtv_sim_bus_EPS			
meps_mtv_sim_bus_EPS			
meps_mtv_sim_bus_INIT			
mptcs_mtv_sim_bus_ECL			
mptcs_mtv_sim_bus_ECL			
eclass.mtvStack.fluid.mtvOvhdMpev.mMalFBlockageFlag		---	Boolean
eclass.mtvStack.fluid.mtvOvhdMpev.mMalFBlockageValue		---	Decimal
atcs.hab1.itcsFluid.pumpA.mMalFBlockageFlag		---	Boolean
atcs.hab1.itcsFluid.pumpA.mMalFBlockageValue		---	Decimal
atcs.hab1.etcsFluidA.pumpA.mMalFBlockageFlag		---	Boolean
atcs.hab1.etcsFluidA.pumpA.mMalFBlockageValue		---	Decimal
atcs.hab1.etcsFluidA.tcvAiso.mMalFBlockageFlag		---	Boolean
atcs.hab1.etcsFluidA.pumpA.mMalFBlockageFlag		---	Boolean
atcs.hab1.etcsFluidA.pumpA.mMalFBlockageValue		---	Decimal
atcs.hab1.etcsFluid8.pumpA.mMalFBlockageFlag		---	Boolean
atcs.hab1.etcsFluid8.pumpA.mMalFBlockageValue		---	Decimal
atcs.hab1.etcsFluid8.tcvAiso.mMalFBlockageFlag		---	Boolean
atcs.hab1.etcsFluid8.tcvAiso.mMalFBlockageValue		---	Decimal
eclass.sabatierFluid.netNodes[0].mContent.mMass		lbm	Decimal
eclass.mtvWaterBus.waterBusNetwork.CdsBrineStorage.mInternalFluid[0].mMass		lbm	Decimal
eclass.mtvWaterBus.waterBusNetwork.CdsWsta.mInternalFluid[0].mMass		lbm	Decimal
eclass.mtvWaterBus.waterBusNetwork.WpaWasteStorage.mInternalFluid[0].mMass		lbm	Decimal

Test Conductor

- Real-time simulation display with full nominal control of the system
- Trick View for malfunction insertion during run-time
- Real-time crew display access
- MCC and Crew mission log
- In-Hab video camera access

Subsystem Simulation Activity Results

Category (Average)	Time (minutes)
Total time per activity	69.35
Response time	5.37
Communication delay	36.00
Other time (MCC Preparation)	7.22
Action time	10.35
Task time	10.41

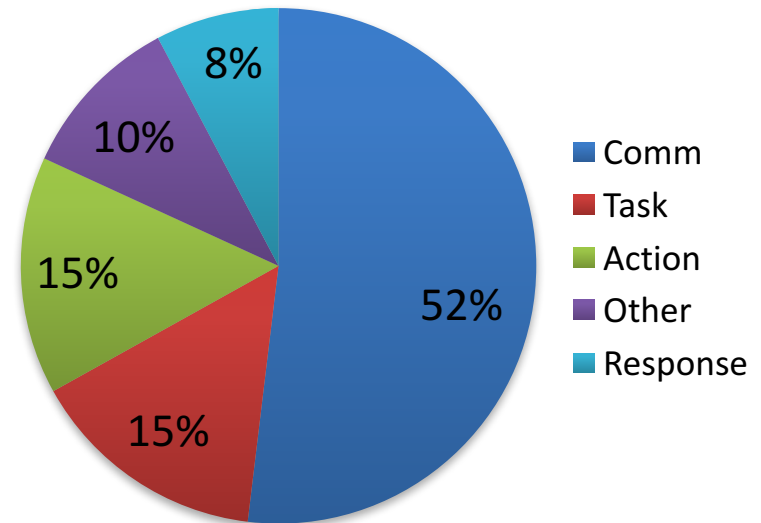

- 5 out of 6 crew members participated in this study
- 8 activities/malfunctions were conducted
- One activity was conducted with real-time communication (excluded)
- Two activities had very long response times due to crew availability (excluded)
- One activity had two communication exchanges
- Time Definition:
 - Response time: amount of time for crew to add the malfunction to the mission log and inform MCC
 - Communication time: time spent due to communication delay
 - Other time (MCC Preparation): amount of time for other actions that include time for the MCC to prepare and send the instructions
 - Action time: amount of time for crew to start working on the task after they received instructions from MCC
 - Task time: amount of time crew actually spent on the task



- **Provide touch screen devices for crew interfaces**
- **Run the simulation on a separate host and connect all three interfaces to it**
- **Have at least one person for each non-crew role (MCC support and Test conductor)**
- **Geographically separate MCC and Test conductor**
 - MCC support will be at NEEMO mission control
 - Test conductor will be at JSC
- **Provide more training for the crew so that they can comfortably operate the system on their own**
- **Add critical malfunctions that require immediate action from the crew**
- **Add more complex malfunctions**
- **Insert malfunctions during other in-Hab activities to better replicate real-world conditions**

