

# Coil-On-Plug Ignition for LOX/Methane Liquid Rocket Engines in Thermal Vacuum Environments

John C. Melcher<sup>1</sup>, Matthew J. Atwell<sup>2</sup>, Robert L. Morehead<sup>3</sup>, Eric A. Hurlbert<sup>4</sup>  
*NASA Johnson Space Center, Houston, TX, 77058, United States*

*and*

Luz Bugarin<sup>5</sup>, Mariana Chaidez<sup>6</sup>  
*The University of Texas at El Paso, El Paso, TX, 79968, United States*

A coil-on-plug ignition system has been developed and tested for Liquid Oxygen (LOX) / liquid methane rocket engines operating in thermal vacuum conditions. The igniters were developed and tested as part of the Integrated Cryogenic Propulsion Test Article (ICPTA), previously tested as part of the Project Morpheus test vehicle. The ICPTA uses an integrated, pressure-fed, cryogenic LOX/methane propulsion system including a reaction control system (RCS) and a main engine. The ICPTA was tested at NASA Glenn Research Center's Plum Brook Station in the Spacecraft Propulsion Research Facility (B-2) under vacuum and thermal vacuum conditions. In order to successfully demonstrate ignition reliability in the vacuum conditions and eliminate corona discharge issues, a coil-on-plug ignition system has been developed. The ICPTA uses spark-plug ignition for both the main engine igniter and the RCS. The coil-on-plug configuration eliminates the conventional high-voltage spark plug cable by combining the coil and the spark-plug into a single component. Prior to ICPTA testing at Plum Brook, component-level reaction control engine (RCE) and main engine igniter testing was conducted at NASA Johnson Space Center (JSC), which demonstrated successful hot-fire ignition using the coil-on-plug from sea-level ambient conditions down to  $10^{-2}$  torr. Integrated vehicle hot-fire testing at JSC demonstrated electrical and command/data system performance. Lastly, Plum Brook testing demonstrated successful ignitions at simulated altitude conditions at 30 torr and cold thermal-vacuum conditions at 6 torr. The test campaign successfully proved that coil-on-plug technology will enable integrated LOX/methane propulsion systems in future spacecraft.

## Nomenclature

<i>APU</i>	= Avionics and Power Unit
<i>EMI</i>	= Electro-Magnetic Interference
<i>ICPTA</i>	= Integrated Cryogenic Propulsion Test Article
<i>JSC</i>	= Johnson Space Center
<i>LOX</i>	= Liquid Oxygen
<i>MIB</i>	= Minimum Impulse Bit
<i>PCAD</i>	= Propulsion and Cryogenics Advanced Development
<i>RCE</i>	= Reaction Control Engine
<i>RCS</i>	= Reaction Control System

---

<sup>1</sup> Propulsion System Engineer, Propulsion Systems Branch EP4, AIAA Senior Member

<sup>2</sup> Propulsion System Engineer, Propulsion Systems Branch EP4, AIAA Member

<sup>3</sup> Propulsion System Engineer, Propulsion Systems Branch EP4, AIAA Member

<sup>4</sup> Propulsion System Engineer, Propulsion Systems Branch EP4, AIAA Member

<sup>5</sup> Citation for Luz for 2016

<sup>6</sup> Citation for Mariana for 2016

## I. Introduction

MANY LOX/methane liquid rocket engine test projects have utilized spark-ignition devices for both main engine igniters and reaction control engines. Spark-ignition devices have proven to be a high-reliability technique for LOX/methane ignition for both main engines and RCE, including vacuum testing. For example, NASA previously tested spark-ignition systems for LOX/methane engines during the Propulsion and Cryogenics Advanced Development (PCAD) project<sup>1</sup> and also during subsequent integrated test projects (e.g., Project Morpheus<sup>2</sup>). Some test issues have arisen during different test projects on the spark-plug approach, including spark plug durability (e.g., ceramic cracking) and corona discharge during simulated altitude testing. These issues have continued to be improved upon in subsequent test projects.

Corona discharge in reduced altitude environments is an electrical breakdown at high voltage components that cause loss of electrical energy at the desired spark gap or damage to components if arcing occurs at the high-voltage components. The corona discharge is typically evident by luminous discharge (shown in Figure 1a) and a drop in measured power. The range of concern for corona discharge is described by Paschen's curve, typically showing the minimum breakdown voltage required across different spark gap distances at various ambient pressures and gas compositions (notionally shown in Figure 1b). The lowest breakdown voltages are typically in the 1 to 10 torr-cm range depending on the gas, which indicates that corona discharge can be a significant problem for propulsion systems testing at altitude conditions or in a Mars environment condition (~4.5 torr, ~95% carbon dioxide, CO<sub>2</sub>).

Conventional spark-plug systems typically use an induction coil to transform power supply voltage (e.g., 12 vdc or 28-32 vdc) into  $>10^3$  volts to generate a spark. The sensitivity to corona discharge is that the high-voltage cable, or "high tension lead," from the external coil to the spark plug itself carries the high voltage in excess of the minimum breakdown voltage, typically  $\sim 10^2 - 10^3$  predicted in Paschen's curve.

NASA previously tested spark-ignition systems for LOX/methane engines in simulated altitude conditions during the PCAD project in 2005-2010. During PCAD, some engines were tested in vacuum with external coils with high-voltage leads that were purged or pressurized.<sup>3</sup> When exciter configurations were used without adequate vacuum protection (e.g., inadequate purge gas), degraded spark output was observed, leading to no-light conditions.<sup>4</sup>

NASA and its contractors successfully vacuum-tested "compact exciters", many of which were in "breadboard" or "proof of concept" development stage during PCAD. These tests proved that igniter devices can be successfully developed to eliminate the high-voltage lead and corona discharge effects. Under the PCAD project (Ref. 1), Unison developed a "compact exciter" that eliminated the high-voltage cables, and Small Business Innovative Research (SBIR) projects were completed with Alphasort. The Unison compact exciter was successfully demonstrated during simulated altitude testing on a 100 lbf RCE.<sup>5</sup> For LOX/methane ignition testing, PCAD recommended that further investigation was still needed for igniters operating in cold thermal environments. [Cite Bill Marshalls' 2017 AIAA paper if avail.](#)

In 2016-2017, hot-fire testing was conducted on the Integrated Cryogenic Propulsion Test Article (ICPTA) at NASA Glenn Research Center Plum Brook Station. This test project was completed as part of Plum Brook Test Cell B-2 facility characterization project, and provided an opportunity to test integrated LOX/Methane propulsion technologies using the ICPTA at simulated altitude conditions and thermal cold-wall conditions. More information regarding the test project can be found in Reference 6.

The ICPTA uses an integrated, pressure-fed, cryogenic LOX/methane propulsion system including a reaction control system (RCS) with two 28 lbf-vac, two 7 lbf-vac engines, and one 2,800 lbf-vac main engine (See Figure 2). Details of the ICPTA RCS can be found in Reference 7. Previous sea-level testing of the ICPTA during Project Morpheus used conventional automotive spark plugs with external coils connected by high-voltage cables (see Figure 3a). For the simulated altitude testing, the ICPTA spark plug/coil devices were replaced with a coil-on-plug spark ignition devices, which eliminated the high-voltage cable and risk of corona discharge energy losses.

## II. Test Article Description

For simulated-altitude ICPTA testing, NASA worked with commercial vendors to modify off-the-shelf racing automotive heritage coil-on-plug spark-plug systems for use with LOX/methane igniters (shown in Figure 3b). The coil was fabricated by WeaponX Performance Products, LTD., and the coil was custom-modified by the vendor to be vacuum-potted into a threaded interface nut in order to mount into the existing spark plug ports on the ICPTA RCE and main engine igniters (shown in Figure 4). NASA separately fabricated custom electrode tips, which were then thread-mounted into the potted coil body. The vacuum potting prevented pressure/vacuum leakage into the coil body and maintain spark location at the electrode tip. The electrodes were custom-built separately so that the coils

or electrodes could be line-replaceable within each RCE or main engine igniter, which had different electrode geometries within the igniters.

The epoxy insulation selection was initially completed by the vendor and required a high di-electric strength to maintain insulation between the electrode at  $\sim 10^3$ - $10^4$  vdc and the thread adapter, which is grounded into the body of the igniter. Furthermore, the potting must be able to survive both cold and hot thermal conditions. For example, the RCE electrode tip can see liquid oxygen temperatures at  $\sim 250$  degF, while the main engine igniter electrode tip can see combustion temperatures at  $\sim 1000$ 's degF. The potting was installed in the coil body under vacuum conditions to prevent voids.

Subsequent testing at NASA proved that additional modifications for the potting and electrode thermal and electrical insulation can ensure quality operation in the hot-gas igniter environment. For example, the hot-gas environment inside the igniter could lead to epoxy erosion and subsequent loss of spark at the electrode tip. A combination of ceramic insulators and high-temperature potting is required to provide repeatable performance of electrode sparking. Selection of the ceramics also presented a new problem because some of these configurations would allow sparking across the face. Although test results proved that the devices provide adequate spark energy for ignition, further investigation is needed in ceramic and high-temperature epoxies for the igniter application.

The coils integrated into the ICPTA were all 12 vdc coils since the existing power system for the ICPTA used conventional automotive 12 vdc coils. The ICPTA used a 16 vdc power supply, which was also input at Plum Brook B-2 for testing. A single 24 vdc coil was also tested stand-alone in the vacuum bell jar since the 28 vdc represented a more flight-like voltage system (e.g., 28-32 vdc). No new issues were uncovered in the 28 vdc vacuum bell jar testing, and neither the 12 vdc nor 24 vdc coils demonstrated any corona discharge in the bell jar testing.

The ICPTA trigger command for all the igniters is 100 sparks per second at 50% duty cycle, which was the heritage command output from the ICPTA controller from Project Morpheus. The coil vendor recommended maintaining the duty cycles at 12-15% to maintain life and avoid overheating the coils. Vacuum bell-jar performance testing revealed that adequate thermal margin was maintained operating at the high 50% duty cycle, even after several minutes of continuous operation.

The target spark energy requirement for the ICPTA was 35 mJ. Testing on the 12 vdc coil demonstrated only  $\sim 22$ - $24$  mJ spark energy at 50% duty cycle (described below). Vendor testing proved that the 28 vdc coil met this requirement with duty cycles as low as 13%.

In the configuration tested in 2016-2017, the coil body did not include the electronics (e.g., transistors) to switch the 16 vdc power based on the 5 vdc trigger voltage. ICPTA testing included a vendor supplied ignition electronics device for the switching, but this was not vacuum-rated before the start of testing. Subsequent development work by the vendor may provide a device capable of being integrated onto the igniter body to reduce the long wire high-current issues. However, for the ICPTA testing completed at Plum Brook B-2, the coil electronics were co-located with the ICPTA avionics and power unit (APU) controller outside of the vacuum test cell in a purged enclosure (see Figure XX). This configuration included a  $\sim 50$  ft long wiring harness from the electronics to the test article, which not only included the igniter power circuits (now at high amperage,  $\sim 7$ - $9$  amps), but also included over 120 other APU command and data channels fed through a common bundle and test cell vacuum feedthrough connector (note that ICPTA testing had more than 350 command/data channels total including facility data systems). Stand-alone Electro-Magnetic Interference (EMI) testing was not conducted on the wiring harness, but multiple functional checkouts of the system operation and data integrity were conducted during build-up and sea-level testing prior to the Plum Brook testing. All of the command and data wiring in the harness utilized shielded, twisted pair wiring, with the exception of the thermocouple wires. In addition to the switching electronics, a vendor-supplied "condenser" was included to help reduce voltage flyback from the igniter to the APU controller.

### III. Test Results

#### A. Vacuum Bell Jar Electrical Testing

Prior to ICPTA testing at Plum Brook, tests at NASA JSC demonstrated the performance of the coil-on-plug igniters at a component level. First, electrical tests were conducted in a vacuum bell jar to prove no corona discharge would be observed external to the coil during electrical operation from  $50 - 10^{-4}$  torr (see Figure 5). Both the ICPTA 12 vdc coils and the pathfinder 24 vdc coils were tested. The electrical tests both in ambient bench-top and vacuum bell jar configurations were conducted without the ICPTA controller (APU). Tests were completed using 12 vdc bench-top power supplies and breadboard circuits for the 5 vdc trigger signal. During these tests, trouble-shooting was completed on several issues with the firing circuit related to the use of function generators and high-voltage probes that were not part of the ICPTA configuration.

During this testing, no corona discharge was observed on the 12 vdc coils at pressures ranging from 50 - 10<sup>-4</sup> torr nor on the 24 vdc coils at pressures from 50 - 10<sup>-2</sup> torr. Tests were conducted on the 12 vdc coil up to ~115 sec in duration, and the 24 vdc coil was tested up to ~15 sec.

Bench-top testing was conducted to measure spark energy for the 12 vdc coil. This testing was conducted at ambient conditions, not in the vacuum bell jar, because the bell jar configuration did not permit a direct electrode current discharge measurement. High voltage measurement was made at the electrode, and current was measured through the grounding path discharge wire, shown in Figure YY. The 12 vdc coil measurements showed a spark energy of ~22-24 mJ. The previous conventional 12 vdc coil used on the ICPTA during Project Morpheus was re-tested and demonstrated ~37 mJ spark energy. Early tests had demonstrated lower spark energy, but it was determined that the power supplies were current limited, unlike the ICPTA APU configuration at 16 vdc and high-current capability. The measured spark energy was acceptable to begin hot-fire testing checkouts based on....

The electrical firing circuit was also been developed to prevent high-voltage fly-back into the electronics and improve grounding. Flyback was measured as high as 75 vdc magnitude in some instances. A vendor-supplied “condenser” was added to the circuit to reduce the voltage fly-back magnitude. Additionally, test results were improved if the grounding path was shortened and made more robust. Using the ICPTA Plum Brook configuration ~50 ft wiring length and the vendor-supplied condenser, flyback voltage was reduced down to <20 vdc. This magnitude of voltage flyback was accepted by the ICPTA test team after testing of the sea-level conventional coil used during Project Morpheus was similarly measured to generate flyback voltages up to 30 vdc.

During these vacuum bell jar tests, a thermocouple was added to the coil body to measure temperature of the coil during extended run times at the high duty cycle (50%). The max temperature recorded was 130 degF, which fell within the manufacturer recommended max allowable at 200 degF.

## **B. Vacuum Component-Level Hot-Fire Testing**

Component-level hot-fire testing was conducted on the ICPTA 28 lbf-vac RCE, 7 lbf-vac RCE, and the main engine igniter. This hot-fire test series was conducted on the NASA JSC Cryo-Cart test bed (shown in Figure 6a). Hot-fire tests were conducted both at ambient and vacuum conditions. The Cryo Cart test bed is a mobile LOX/methane propulsion test article capable of testing RCE in the 100 lbf thrust range or smaller. For vacuum testing, a new “vacuum pipe” test article was designed and fabricated that allowed for ignition testing in vacuum conditions (shown in Figure 6a and 6b). The test vacuum pipe included an intrinsically safe flapper door that would open during testing, but would allow for short-duration ignition demonstrations of the RCE and main engine igniter. In the vacuum pipe, test durations were limited by a hazard analysis that conservatively bounded the potential combustible environments generated during a potential RCE no-light condition. The 28 lbf-vac RCE testing was limited to 200 msec maximum run time, the 7 lbf-vac RCE testing was limited to 700 msec, and the main engine igniter testing was limited to 500 msec. As part of the test controller sequence, a high-flow gaseous nitrogen purge was activated in the vacuum pipe at the end of each individual thruster test sequence.

For the vacuum pipe testing, the ICPTA controller was not used, and the Plum Brook configuration ~50 ft harness was not used. The Cryo Cart on-board National Instruments CompactRIO control and data acquisition system was used. Spark coil power and triggering was controlled from the CryoCart CompactRIO using solid-state relays commanding a standalone power-supply and the same trigger breadboard circuit used during bench-top electrical testing. The power supply used was an Extech Model 38225 1-30 vdc / 1-20 A variable power supply set to 16 vdc. Similar to the Plum Brook test configuration, the igniter electronics were installed outside of the vacuum pipe environment.

Prior to the start of vacuum-pipe testing, checkout ambient testing showed that modifications were required to the coil electrode insulation to prevent epoxy erosion the hot-gas environments of the igniters. Figure 6c shows the RCE stand in the ambient-test configuration. The RCE tests demonstrated 163 lights with one no-light attributed to a coil failure. The main engine igniter demonstrated 10 successful tests at ambient conditions with no coil failures. Additional no-lights were observed due to test configuration errors (e.g., incorrect/intermittent wiring or incorrect/insufficient orificing) or propellant conditioning (e.g., methane inlet conditions too cold), described in more detail in Reference 7.

Tests of the 28 lbf-vac RCE demonstrated vacuum ignition at 50 – 0.03 torr (shown in Figure 7a). The first vacuum test conducted demonstrated a no-light due to propellant conditioning, but the remaining 9 tests on the 28 lbf-vac RCE were successful. Next, 9 vacuum tests were conducted on the main engine igniter with zero “no lights” in vacuum conditions (shown in Figure 7b). Tests of the 7 lbf-vac RCE were performed last in the test campaign and demonstrated vacuum ignition at ~3 - 4 torr. A summary of the Cryo Cart – Vacuum Pipe component level test conditions is shown in Table 1.

The test effort on the 7 lbf-vac thruster was reduced to only three tests following the successful testing of the 28 lbf-vac and the main engine igniter. Tests conducted at ~1 torr or higher were completed using a scroll pump, and tests less than ~1 torr required a turbo-molecular vacuum pump and more complex test operations to reduce vacuum leakage. Because of the increased test costs and time for the <1 torr testing, further risk reduction testing for the 7 lbf was not conducted and technical risk was considered acceptable based on the 28 lbf-vac and main engine igniter test successes.

**Table 1. Summary of Vacuum test conditions for component-level hot-fire testing on the CryoCart Vacuum Pipe Test apparatus at JSC.**

Test Conditions	28 lbf-vac RCE tests (torr)	ME Igniter tests (torr)	7 lbf-vac RCE tests (torr)
<b>10-50 torr</b>	50, 20, 10	10, 20, 50	
<b>1-10 torr</b>	1.5*, 2.3, 2.9, 1.2	1.4	2.6, 4, 4
<b>0.1 – 1 torr</b>	0.35	0.67, 0.97, 0.15, 0.1	
<b>0.01 – 0.1 torr</b>	0.03, 0.065	0.025	

Note: \* no-light due to propellant conditioning

### C. Sea-Level Integrated Hot-Fire Testing

The final test series at NASA JSC for the coil-on-plug included fully integrated hot-fire testing of the ICPTA with tests demonstrating simultaneous main engine and RCS operation at sea-level conditions (Figure 8). The tests were conducted as part of vehicle risk-reduction prior to delivery to Plum Brook due to configuration changes on the vehicle, including the use a newly-fabricated main engine injector and a complete disassembly and re-assembly of the propulsion system for insulation and vacuum-rated actuators. These tests were conducted on the JSC on-site antenna test range where previous Project Morpheus and Cold Helium ICPTA testing was conducted from 2012-2015. The vehicle was suspended from a crane in a static position over a main engine hot-fire flame trench. The vehicle-level tests included the Plum Brook configuration avionics using the ICPTA controller (APU) and the 50 ft vacuum feedthrough connector (shown in Figure 8a).

The integrated vehicle hot-fire tests successfully proved that the integrated electronics could operate all five of the coil-on-plug igniters simultaneously and in test sequence (e.g., main engine with RCS pulsing) without significant electro-magnetic interference (EMI) problems or voltage fly-back problems into the ICPTA avionics and power controller. The only remaining configuration not tested during the JSC ICPTA sea-level tests was the Plum Brook facility power supply to the ICPTA controller (APU). For the JSC testing, the APU was powered by JSC-provided 16 and 32 vdc power supplies powered by a gasoline generator.

During the sea-level integrated testing, failures of the coil-on-plug installation revealed that additional electrode epoxy and ceramic insulation improvements were required, specifically on the main engine igniter. Following an initially successful main engine igniter-only demonstration test, the main igniter coil failed to reliably provide spark energy at the electrode due to the epoxy/ceramic installation. Two different tests on the main engine were unsuccessful and required main engine igniter coil repair and replacement. The modified coils were then re-screened and subsequent vehicle-level testing was successful.

The RCE coils successfully demonstrated hot-fire testing without any coil failures in 62 tests. The main engine igniter successfully demonstrated hot-fire testing in 9 tests following the repair work, including simultaneous main engine and RCE sequences (shown in Figure 8b).

### D. Simulated Altitude Integrated Hot-Fire Testing

ICPTA testing in the Plum Brook B-2 facility was conducted at simulated altitude conditions and in both ambient-temperature and cold thermal conditions (shown in Figure YoYoa). The first set of tests were performed under ambient temperature and simulated altitude pressure conditions ~30 torr. These tests consist of a range of minimum impulse bit (MIB) pulsing sequences with low duty cycle, analogous to a coast phase in which the RCS is primarily used for station keeping. Higher duty cycle pulsing tests were also performed, analogous to an ascent or landing mission phase. Lastly, tests with longer pulses and multiple engines firing either in sequence or simultaneously were run in order to gather transient system response data. Integrated tests were also performed to demonstrate simultaneous main engine and RCS operation (shown in Figure YoYob). Details of the test campaign can be found in Reference 6, and a detailed description of the RCS test results are described in Reference 7. The baseline test plan included testing a much lower pressures, but those test conditions were not achieved due to vehicle system leakage and facility vacuum leakage.

During the ambient temperature vacuum testing, 959 successful RCE hot-fire tests were completed without any spark coil failures. No vacuum corona discharge was observed in any of the test conditions external to the coil bodies. Some no-lights on the RCS were observed, but these were attributed to propellant conditioning, as was observed during sea-level component-level testing.

Similar to sea-level integrated testing, the main engine igniter spark coil demonstrated one failure to provide spark energy at the electrode during the ambient-temperature altitude testing due to high-temperature erosion in the main engine igniter. Subsequent repair and replacement of the electrode epoxy and ceramic insulation was required. During the test campaign, 18 successful main engine igniter lights were demonstrated in igniter-only testing, main engine testing, and integrated testing.

The electrical system performed as expected following the sea-level integrated tests. No new issues were uncovered operating the spark coils in the Plum Brook installation using the facility power supply. No new EMI issues were uncovered in the ICPTA controller (APU) data. Some Plum Brook high-speed data channels (that were not included in the sea-level testing at JSC) did include some 120 Hz electrical noise during coil firings, but the amount of noise was acceptable within signal-to-noise tolerances for the high-speed data analysis.

### **E. Thermal-Vacuum Integrated Hot-Fire Testing**

The last set of tests were performed with the B-2 cold wall active flooded with liquid nitrogen, and the vehicle was under cold-soak for over ~40 hours. The average test cell chamber was ~-305 degF during this cold soak, and pressures began at around 0.02 torr. By the time RCS testing began, the test cell pressure had increased to ~6 torr due to vehicle leakage and test cell vacuum leakage. RCE jet body temperatures reached ~-200 to -225 degF. As the RCS was conditioned for hot-fire, the RCE jet body temperatures dropped to -325 degF in some cases.

Under the cold thermal conditions, several no-lights were observed on the RCE under similar conditions that were successful at ambient temperature (shown in Figure ZZa). Two RCE lights were demonstrated on the RCE after warm GN2 purge flow was introduced to warm the jet bodies before light (shown in Figure ZZb). One jet coil mechanically failed during these cold thermal conditions due to inadequate plastic-to-metal bonding of the coil body housing, and further RCS hot-fire testing was not attempted within the test campaign time remaining. Due to other system leakage on the ICPTA, the main engine igniter was not tested under the cold thermal conditions.

The root cause of the no-lights in the cold-thermal conditions is still under review, and more details can be found in Reference 7. The cold-body no-lights were not attributed to spark plug coil failures since video imagery show the RCE core flow ignition, followed by quenching of the jet by the fuel film cooling flow within the jet. However, further testing is needed to verify if the quenching could have been overcome with an increase in spark energy or increased spark time or jet duration (the no-lights were observed during MIB testing at 40-60 msec).

## **IV. Summary/Conclusions/Forward Work**

Test results show that coil-on-plug technology provides a viable means providing spark energy for LOX/methane liquid rocket engine igniters. Table 2 is a summary of all the testing conducted using the coil-on-plug igniters for the RCE and main engine igniters in this study at sea-level, vacuum, and thermal-vacuum conditions. It is critically important to note that this study was not intended to be a reliability study, otherwise, orders of magnitude more hot-fire pulses would have been performed. Instead, this study focused on demonstrating that coil-on-plug spark igniter technology could be used in integrated LOX/methane propulsion systems. A secondary objective demonstrated was that the coil-on-plug technology could be derived from low-cost off-the-shelf commercially-available sources.

Future work on the coil-on-plug technology should focus on cold thermal-vacuum testing and hardware reliability. The thermal-vacuum testing at Plum Brook identified a key issue that needs further investigation with operating a cryogenic RCS in space conditions. The thermal-vacuum testing was truncated due to test schedule and cost for the overall ICPTA test effort. Modifications to the Cryo Cart – vacuum pipe test article at JSC are under consideration in order to conduct thermal-vacuum ignition testing at the component level. Additional improvements for hardware reliability are also under consideration for electrode epoxy and ceramic insulation modifications.

**Table 2. Summary of successful hot-fire ignition and coil-on-plug failures observed in sea-level, altitude, and thermal-vacuum testing for RCE and Main Engine Igniters.**

Test Series	RCE lights	RCE Coil failures	ME igniter lights	ME Igniter Coil failures
Component-test, Sea-level (CryoCart at JSC)	163	1	10	0
Component-test, Vacuum 0.02 - 50 torr (CryoCart + Vac pipe at JSC)	12	0	9	0
Integrated Vehicle Test, Sea-level (at JSC)	~62 (TBR)	0	9	2
Integrated Vehicle test, vacuum ~30 torr (at PB-B2)	~959	0	18	1
Integrated Vehicle Test, Thermal-Vacuum, ~6 torr (at PB-B2)	2	1	Not tested	Not tested

### Acknowledgements

The coil-on-plug development and JSC testing was funded by the JSC Engineering Directorate, Propulsion and Power Division, Edgar Castro, Chief. ICPTA vehicle development was funded by the JSC Engineering Directorate, Laurie Hansen, Director. Plum Brook Hot-Fire facility testing was funded by the NASA Rocket Propulsion Test Management Board, Roger Simpson, Chair, and Glenn Research Center Plum Brook Propulsion Test Facility, Gerald Hill, Lead. Additional travel funding for hot-fire testing at Plum Brook was funded by Science Technology Mission Directorate, Advanced Exploration Systems, XXX (head of AES), and John Olansen at JSC.

Mark Lepore of WeaponX, LTD, provided vendor engineering design support for the coil technology development and testing.

Propulsion Engineering at JSC was also provided by Patrick McManamen, Mark Villemarette, Jacob Collins, Brian Banker, John Applewhite, Marty Mclean, and Josh Sooknanon. Additional University of El Paso students Daniela Aguilar, Mariano Mercado, Mariana Chaidez, and Pedro Nunez provided test support at JSC and Plum Brook.

Testing at Plum Brook Testing was conducted by Hal Weaver, Brian Jones, John Zang, Nic Connelly, Chris Maloney, Wes Sallee, Brad Weisenberger, Jeremiah Folds, Sage Amato, and countless technicians and engineering staff. Additional test engineering support was provided by Ben Stiegemeier of NASA Glenn Research Center and Andrew Guymon of NASA Stennis Space Center.

Integrated ICTPA vehicle testing at JSC was conducted with the efforts of James Rice, Ian Young, Jennifer Devolites, Steve Daniel, Jessie Zapata, Fred Shetz, Robert Hirsch, Ronnie Gambrel, Kent Dekome, and the hard work of the JSC riggers and technicians.

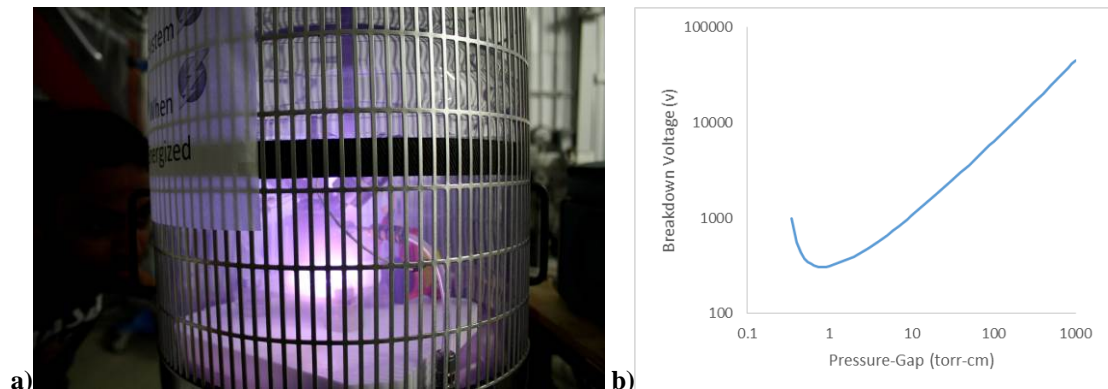

**Figure 1. a) Corona discharge on a conventional automotive coil under vacuum conditions. b) Notional Paschen's curve for breakdown voltage in air**

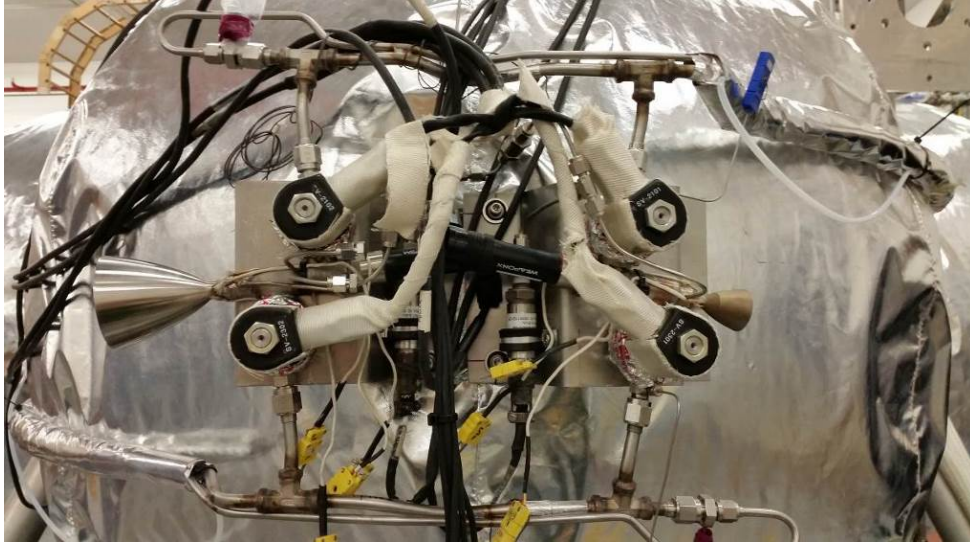

**Figure 2. ICPTA RCS pod with one 28 lbf-vac engine (left) and one 7 lbf-vac engine (right) installed with coil-on-plug spark igniter.**



**a) b)**  
**Figure 3: a): Conventional spark plug with external coil and high-voltage cable used during sea-level testing. b): Coil-on-plug spark plug system with high voltage cable eliminated, used for simulated altitude testing**



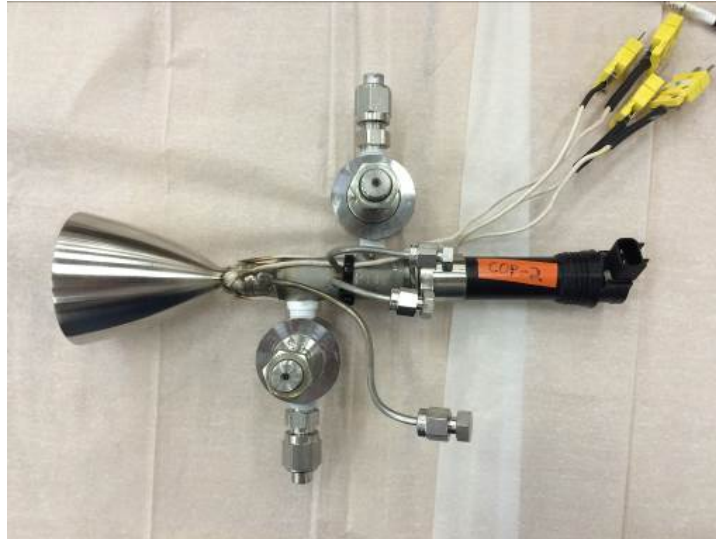

Figure 4. 28 lbf-vac RCE with coil-on-plug igniter installed

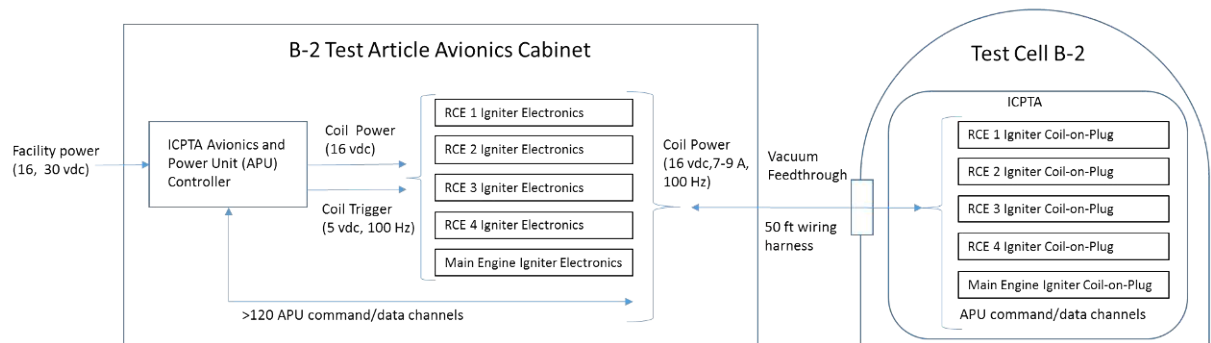
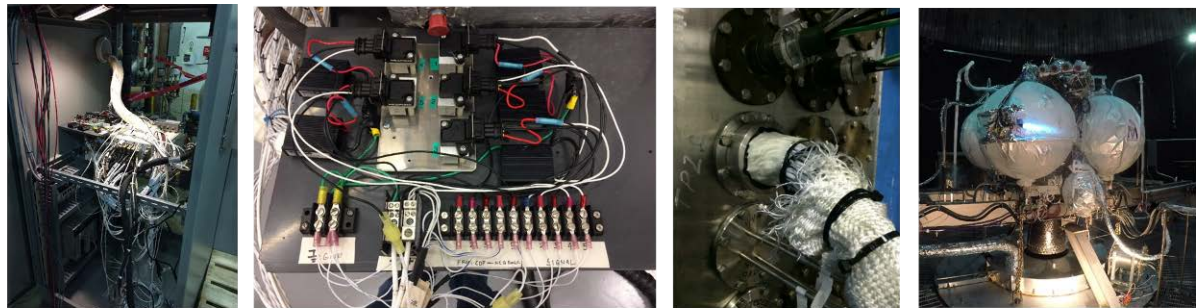
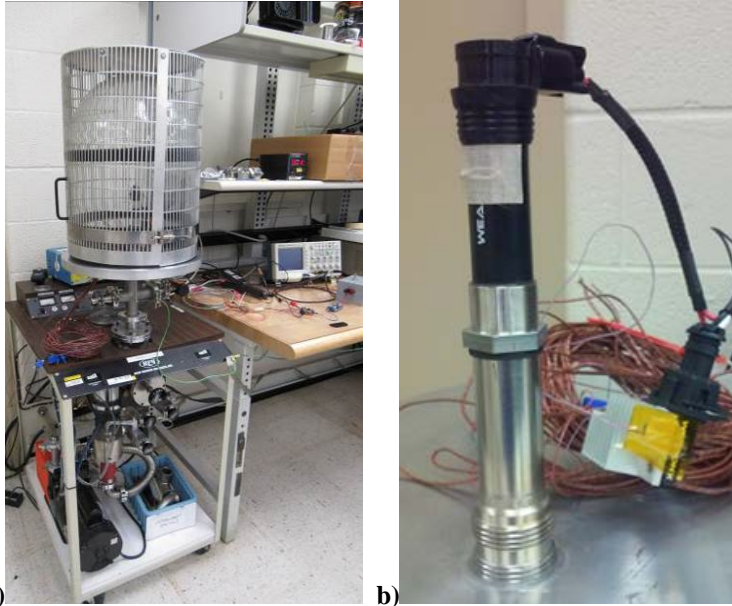
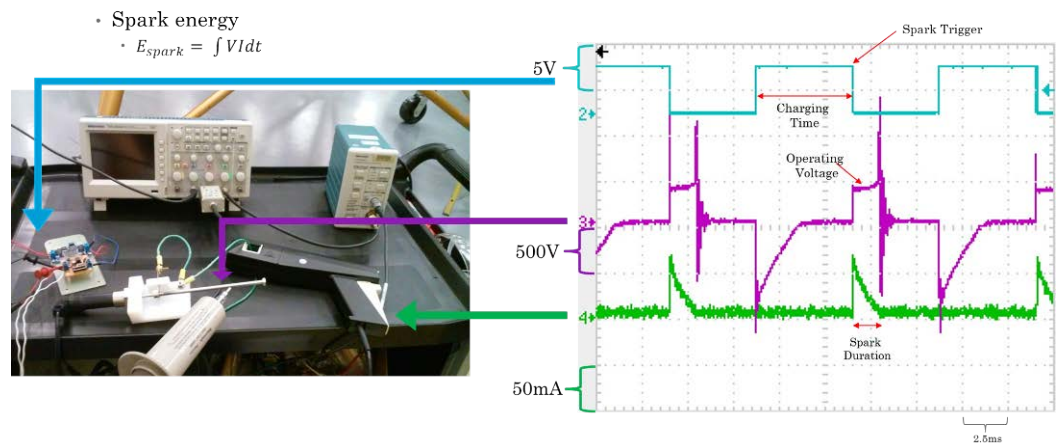

Figure XX. Electrical layout of ICPTA Coil-on-plug ignition system used at Plum Brook B-2 for ICPTA hot-fire testing



**Figure 5. a) Vacuum bell jar electrical test configuration for the coil-on-plug igniter, b) close-up of the coil mounted to the bell-jar feedthrough**



**Figure YY. Bench-top setup to test coil spark energy. Do we want to show this raw data?**



a)

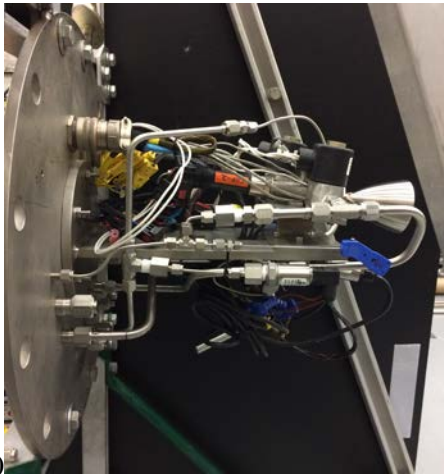

b)



c)

**Figure 6. a) CryoCart test article with vacuum pipe apparatus for hot-fire testing. b) 28 lbf-vac RCE with coil-on-plug igniter mounted on vacuum pipe interface plate, c) 28 lbf-vac thruster mounted on ambient checkout test stand.**

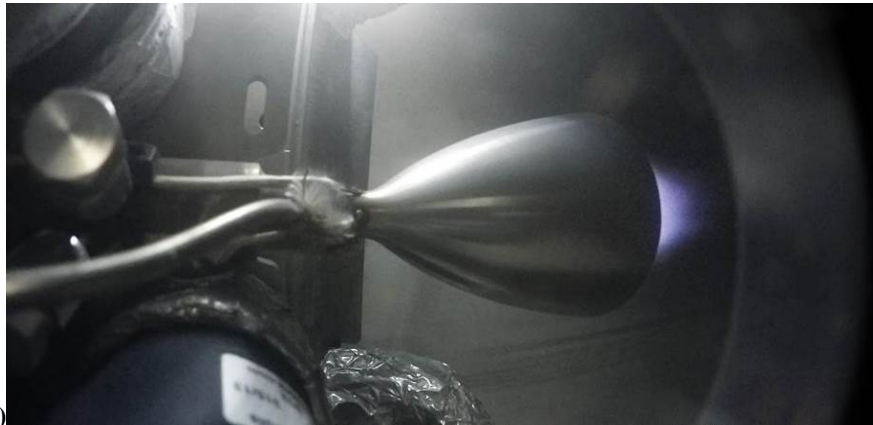

a)



b)

**Figure 7. a) 281bf-vac RCE and b) main engine igniter testing in a vacuum conditions in CryoCart Vacuum pipe using coil-on-plug igniters.**



a) ICPTA sea-level hot-fire configuration with Plum Brook 50 ft avionics harness. b) Hot-fire demonstration with main engine and RCS simultaneous operation with coil-on-plug igniters



a)

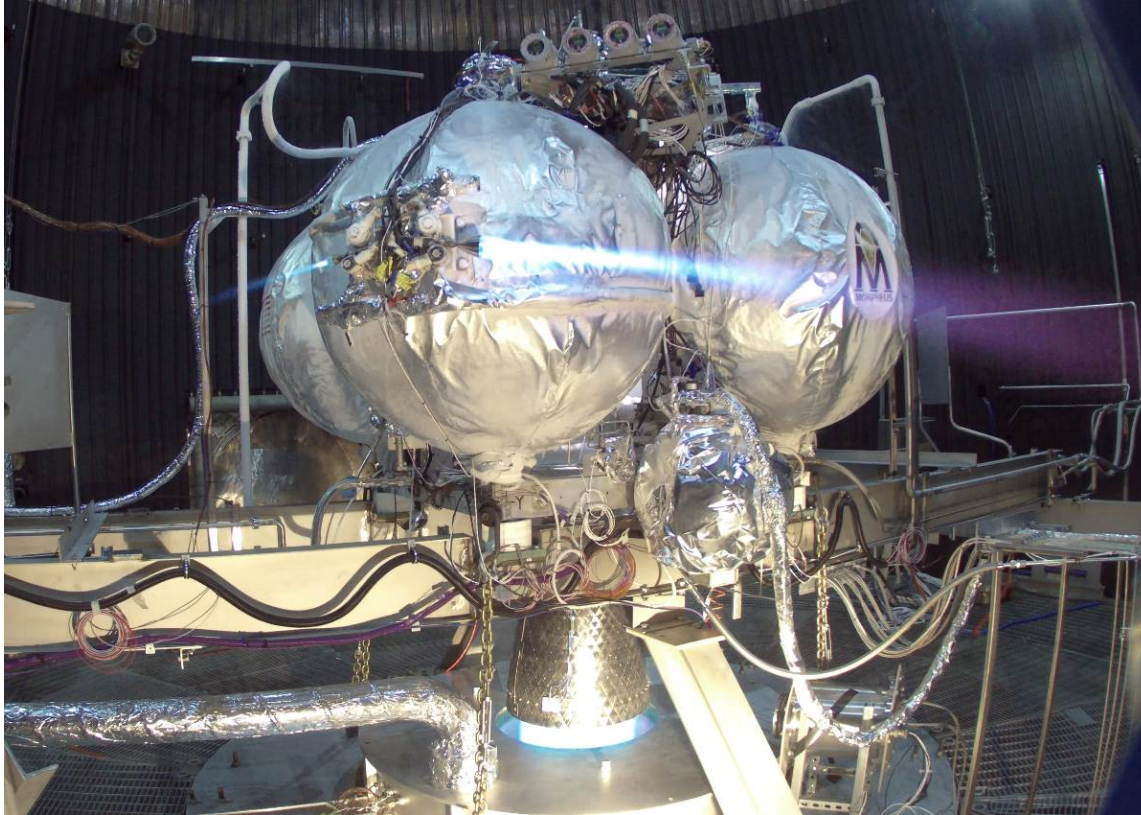

b)

**Figure YoYo**, a) ICPTA installation in Plum Brook B-2 test cell. b) integrated hot-fire demonstration with 7 lbf-vac RCE, 28 lbf-vac RCE, and main engine simultaneous operation.

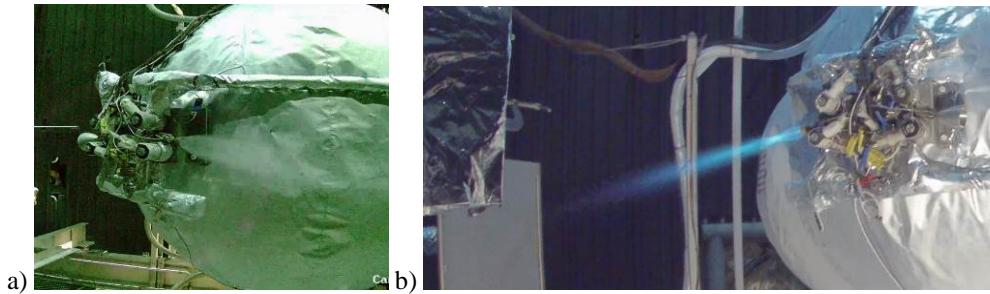

**Figure ZZ. Cold-Thermal Wall Test Imagery of ICPTA RCS testing a) no-light cold-flow (quenched flow), b) successful jet hot-fire after warm GN<sub>2</sub> purge flow**

## References

<sup>1</sup>Smith, T.D., Klem, M.K., and Fisher, K., “Propulsion Risk Reduction Activities for Non-Toxic Cryogenic Propulsion” AIAA-2010-8680, AIAA Space 2010 Conference and Exposition, Anaheim, CA, August 30 – September 2, 2010.

<sup>2</sup>McManamen, J.P., Hurlbert, E.A., and Kroeger, D.J., “Development and Flight Operation of a 5 lbf to 20 lbf O<sub>2</sub>/CH<sub>4</sub> Roll Control Engine for Project Morpheus,” AIAA-2014-3589, 50<sup>th</sup> AIAA/ASME/SAE/ASEE Joint Propulsion Conference, Cleveland, OH, July 28-30, 2014.

<sup>3</sup>Kleinhenz, J., Sarmiento, C., and Marshall, W., “Experimental Investigation of Augmented Spark Ignition of a LO<sub>2</sub>/LCH<sub>4</sub> Reaction Control Engine at Altitude Conditions”, NASA TM 2012-217611, NASA Glenn Research Center, Cleveland, OH, June, 2012.

<sup>4</sup>Hurlbert, E.A., Angstadt, T., Villamarete, M., Collins, J., Allred, J., Mahoney, J., and Peters, T., “870 lbf Reaction Control System Tests using LOX/Ethanol and LOX/methane at White Sands Test Facility”, AIAA-2008-5247, 44<sup>th</sup> AIAA/ASME/SAE/ASEE Joint Propulsion Conference and Exhibit, Hartford, CT, July 21-23, 2008.

<sup>5</sup>Marshall, W. M., and Kleinhenz, J. E., “Summary of Altitude Pulse Testing of a 100-LBF LO<sub>2</sub>/LCH<sub>4</sub> Reaction Control Engine”, 2001-0015DF, Joint Army/Navy/NASA/Air Force (JANNAF) 8<sup>th</sup> Modeling and Simulation, 6<sup>th</sup> Liquid Propulsion, 5<sup>th</sup> Spacecraft Propulsion Joint Meeting, Huntsville, AL, December 5-8, 2011.

<sup>6</sup>Morehead, R.L., Melcher, J.C., Atwell, M.J., and Desai, P., “Integrated Cryogenic Propulsion Test Article Hot Fire Testing,” AIAA 2017-XXX, 2017 AIAA Propulsion and Energy Forum, Atlanta, GA, July 10 -12, 2017.

<sup>7</sup>Atwell, M.J., Hurlbert, E.A., Morehead, R.L., and Melcher, J.C., “Pressure-Fed Cryogenic Reaction Control System for Spacecraft: Transient System Modeling and Hot Fire Test Results,” AIAA 2017-XXX, 2017 AIAA Propulsion and Energy Forum, Atlanta, GA, July 10 -12, 2017.