

Integrated Insulation System for Automotive Cryogenic Storage Tanks

Team:

- Aspen Aerogels (Shannon White)
- Energy Florida (Mike Aller, Tim Franta)
- Hexagon Lincoln (Norm Newhouse, John Eihusen, Duane Byerly)
- IBT (Al Sorkin)
- NASA/KSC (James Fesmire, Adam Swanger)
- SRNL (Don Anton, David Tamburello)
- VENCORE Services and Solutions (Barry Meneghelli)

DOE Annual Merit Review, June 9, 2017

Project ID:ST141

Relevance Overview

Timeline

- Project Start Date: 10/01/16
- Project End Date: 09/30/19 *
- * *Project continuation and direction determined by DOE*

Barriers

- A. System Weight and Volume
- D. Durability/Operability**
- E. Materials of Construction
- F. Balance of Plant components
- J. **Thermal Management**
- N. **Hydrogen Venting**
- O. Hydrogen Boil-off

Budget

- Total Project Budget: \$1.1m
- % Spent: 15

Partners



Relevance

Project Objectives

- **OVERALL**: Development of an integrated subscale insulation system prototype demonstrating the DOE heat leak targets for a cryogenic hydrogen storage tank for commercially produced fuel cell powered automobiles.
- **CURRENT PROJECT YEAR**:
 - Develop concepts for an integrated insulation system
 - Down-select system concepts based on overall system requirements
 - Validate system concepts through component testing



Collaborations

Project Partners

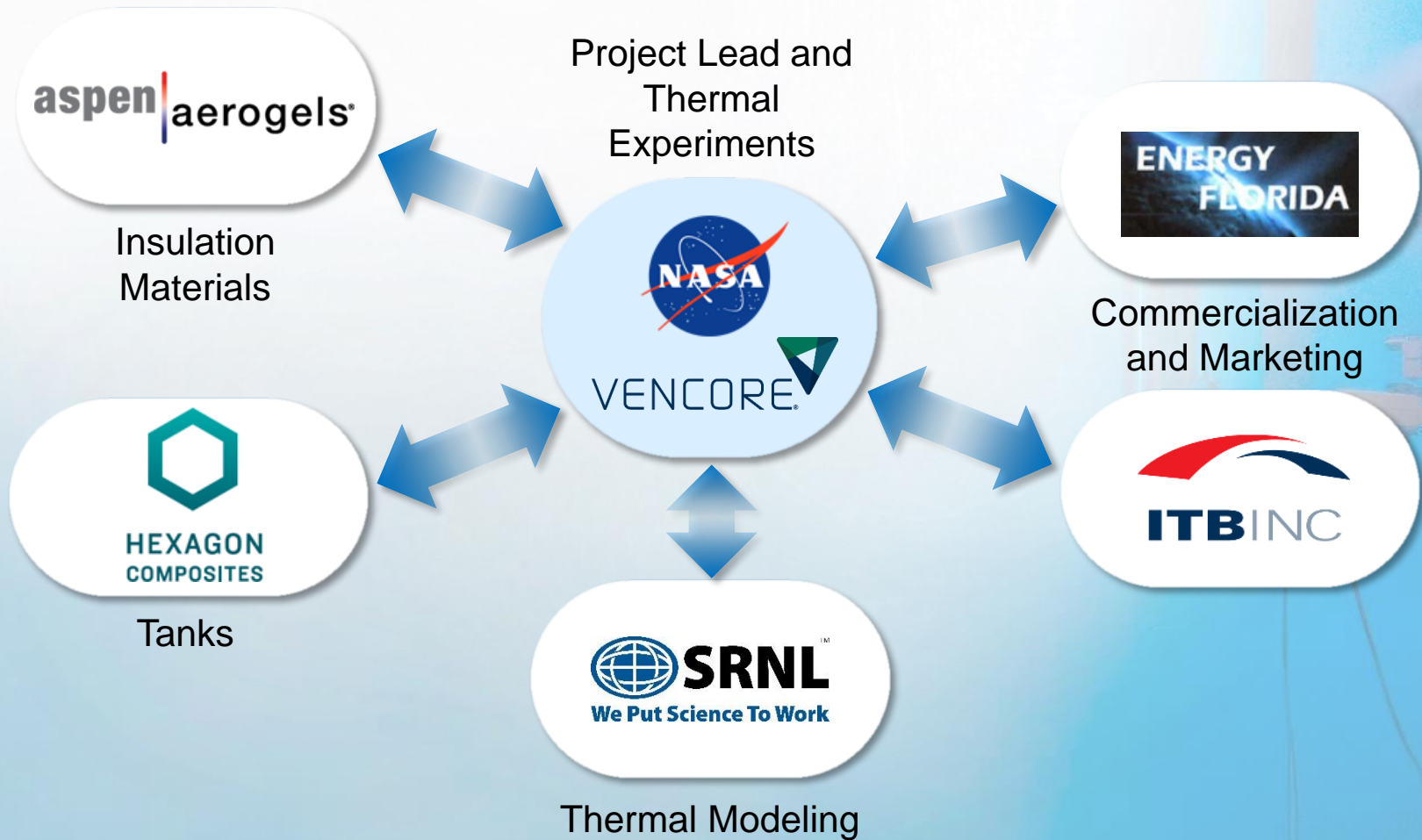

Approach

FY17-FY18 Milestones

- **FY17**
 - Complete preliminary design for full-scale storage system **In-Progress**
 - Down-select potential concept technologies **In-Progress**
 - Complete initial component testing
 - Update system concept based on costs
- **FY18**
 - Complete sub-scale concept modeling and testing
 - Down-select sub-scale concept technology
 - Complete sub-scale prototype design
- **GO/NO-GO (FY17)**
 - Evaluate the existing thermal model under the following constraints:
 - Full-scale (100 L; utilizing both 3:1 and 6:1 l/d tank geometries) hydrogen storage system
 - An insulation system capable of achieving a heat leak $\leq 7\text{W}$ under a reduced vacuum of 0.1 torr
 - An insulation thickness of $\leq 2.5\text{ cm}$
 - A measured cold boundary temperature of 80K (modeled at 40K), at an ambient temperature of 300K, and a 300 bar internal tank pressure that vents at 350 bar.
 - Ensure that the system can achieve the 2020 DOE Dormancy Targets
 - 7 days: Dormancy target time (minimum time until first release of hydrogen from initial 95% usable capacity)
 - 10%: Boil-off loss target (max reduction in stored hydrogen from initial 95% usable capacity after 30 days)



Approach

Integrated Tank: Elements of Heat Transmission

Penetrations

- F Fill Line [End-A]
- V Evacuation/Service [End-B]
- A Auxiliary / Instrumentation

Structural Supports

- S_A Support, End-A
- S_B Support, End-B
- S_C Support, Side (Cylinder)

Facing Surfaces

- R_1 Reflective surface one, Outer of Inner Vessel (zero for $e = 0$)
- R_2 Reflective surface two, Inner of Outer Jacket (zero for $e = 0$)

Thermal Insulation

- Z_{1A} Insulation Zone 1A, End-A support area
- Z_{1B} Insulation Zone 1B, End-B support area
- Z_{2A} Insulation Zone 2A, End-A support area
- Z_{2B} Insulation Zone 2A, End-B support area
- Z_3 Insulation Zone 3, Side (Cylinder)

Insulation Quality Factor (IQF) [degradation; one for each zone]: Q_{1A} , Q_{1B} , Q_{2A} , Q_{2B} , Q_3

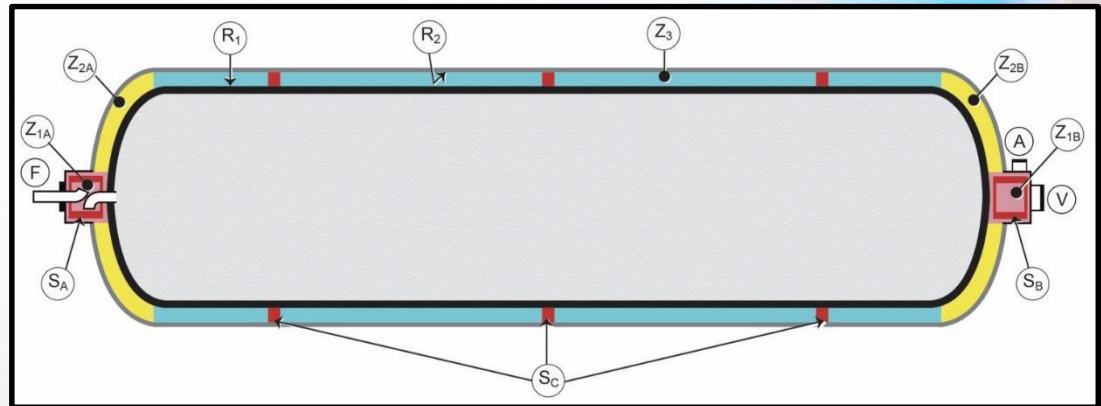

Integrated insulation system materials are chosen to minimize heat loss through each element and, thus, minimize the full heat load.

Approach

Insulation Standards Development

- Cryogenic insulation standards for materials practices and test methods have been developed that promote global energy efficiency
- Under ASTM International's Committee C16 on Thermal Insulation, two new standards are based on CryoTestLab technology and data:
 - ASTM C1774 - *Standard Guide for Thermal Performance Testing of Cryogenic Insulation Systems*
 - ASTM C740 – *Standard Guide for Evacuated Reflective Insulation in Cryogenic Service*
- **Cryostat Test Instruments selected for iCAT development:**
 - **Cryostat-100**, Cylindrical – Absolute, Primary Thermal Data for Insulation Materials/Systems, 1-m tall by 0.2-m diameter test specimens
 - **Cryostat-200**, Cylindrical – Comparative, Prototype Tank Test, 0.5-m tall by 0.2-m diameter
 - **Cryostat-500**, Flat Plate – Absolute, Thermal Data for Insulation Materials, up to 25-mm thickness by 200-mm diameter disk specimens
 - **Macroflash** (Cup Cryostat), Flat Plate – Comparative, Quick Thermal Data for Structural or Insulation Materials, up to 10-mm thickness by 76-mm diameter disk specimens



Approach

Cryostat Testing of Thermal Insulation Systems

Cryostat-500 (two units) and new Vacuum Stability test apparatus (center)



Cryostat-100 and Cryostat-500 provide:

- Full range vacuum (Cold Vacuum Pressure)
- Repeatable testing under representative-use conditions
- Direct energy rate measurement by boiloff calorimetry
- Testing of non-homogenous, non-isotropic materials
- Reference ASTM C1774, Annex A1 and Annex A3

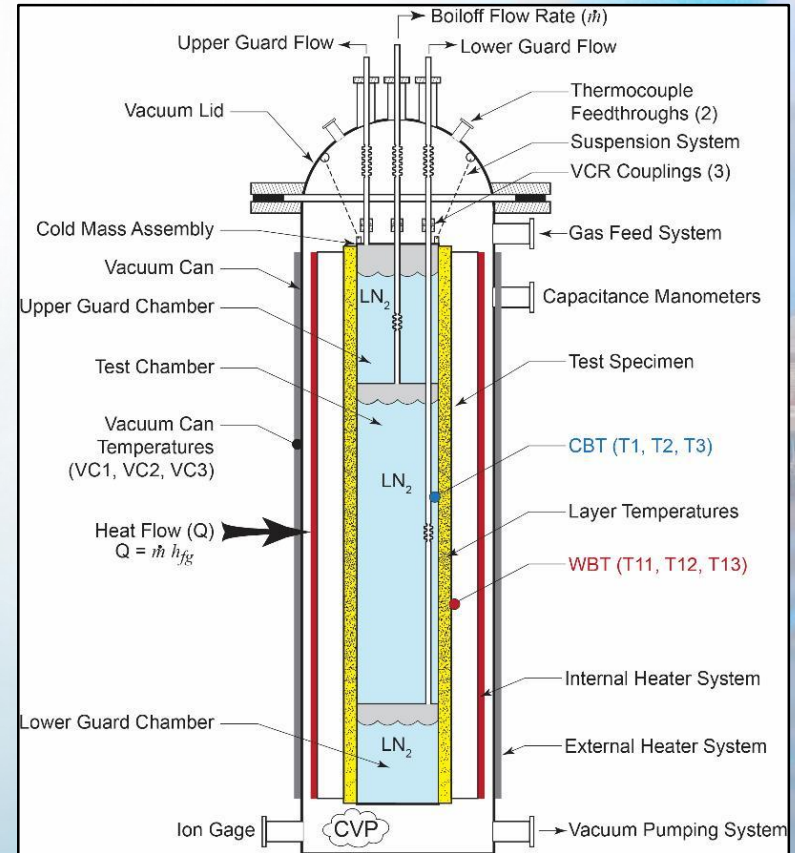

Cryostat-100 Cylindrical Insulation Test Apparatus (Absolute)

Approach

H₂ System Model Diagram

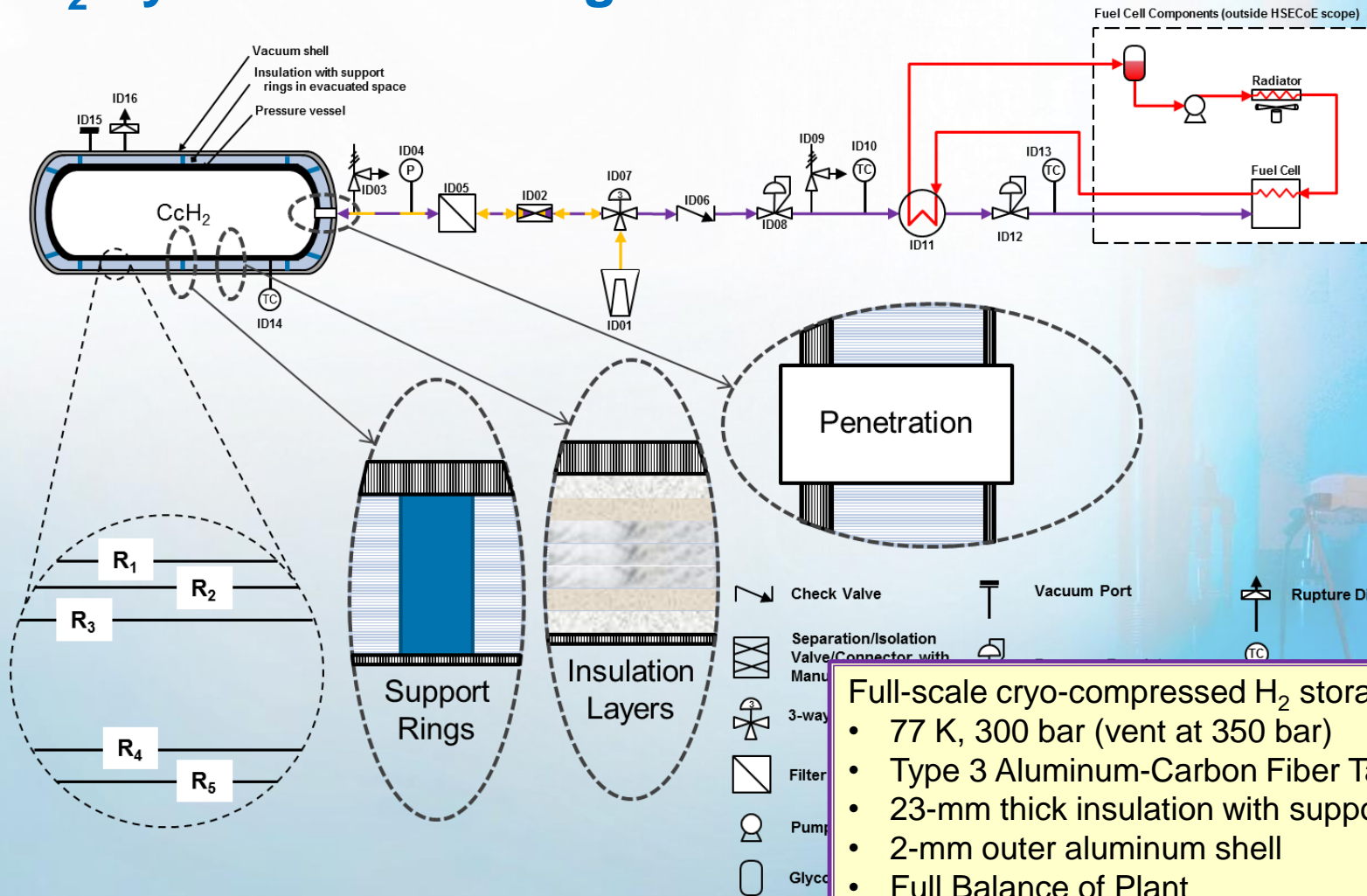

Full-scale cryo-compressed H₂ storage system:

- 77 K, 300 bar (vent at 350 bar)
- Type 3 Aluminum-Carbon Fiber Tank
- 23-mm thick insulation with supports
- 2-mm outer aluminum shell
- Full Balance of Plant

Approach

H₂ System Model Analysis

- **Analysis Results**

- Hydrogen Storage System Design
 - **Pressure vessel, insulation system, and balance of plant**
- **Heat load (Q)** for both the total hydrogen storage system and for individual components/sections of the storage system
- **Heat flux (q)** through both the total hydrogen storage system and the individual components/section of the storage system

- **Inputs and Options**

- Pressure vessel design, including all materials and dimensions
- Hydrogen storage method
 - **Compressed, cold-compressed, cryo-compressed, or liquid**
 - **Adsorbent, metal hydride, or chemical hydride**
- Insulation system
 - **Location and types of support material**
 - **Insulation materials, thickness, and location**
 - **Number and type of penetrations**

Capability to design and test combinations of hydrogen storage methods and insulation systems.



Accomplishments and Progress

Cryostat Thermal Insulation Test Data Mining

- Preliminary Screening Criteria of the Cryogenics Test Laboratory data libraries containing test results:
 - $k_e < 2$ mW/m-K at 100 millitorr *CVP*; any thickness up to 23-mm
 - $q < 20$ W/m² at 100 millitorr *CVP*; based on approx. 23-mm thickness
 - Note: iCAT target thickness is 23-mm (max. annular space thickness)
- To date, 20% of over 700 materials/systems have been analyzed (from over 19 years of data acquisition)
- iCAT target:
 - $Q < 7$ W for 100-liter tank (for 300 K / 78 K boundary temperatures)
 - $q < 5$ W/m² (approx. for 3:1 tank with 23-mm annular space thickness)
 - $k_s < 0.5$ mW/m-K (approx. for **total system** including all elements)

KSC's Cryogenics Test Laboratory has 19+ years of insulation test data available to screen possible insulation and support materials.



Accomplishments and Progress

Selected Cryostat Data: Effective Thermal Conductivity (k_e)

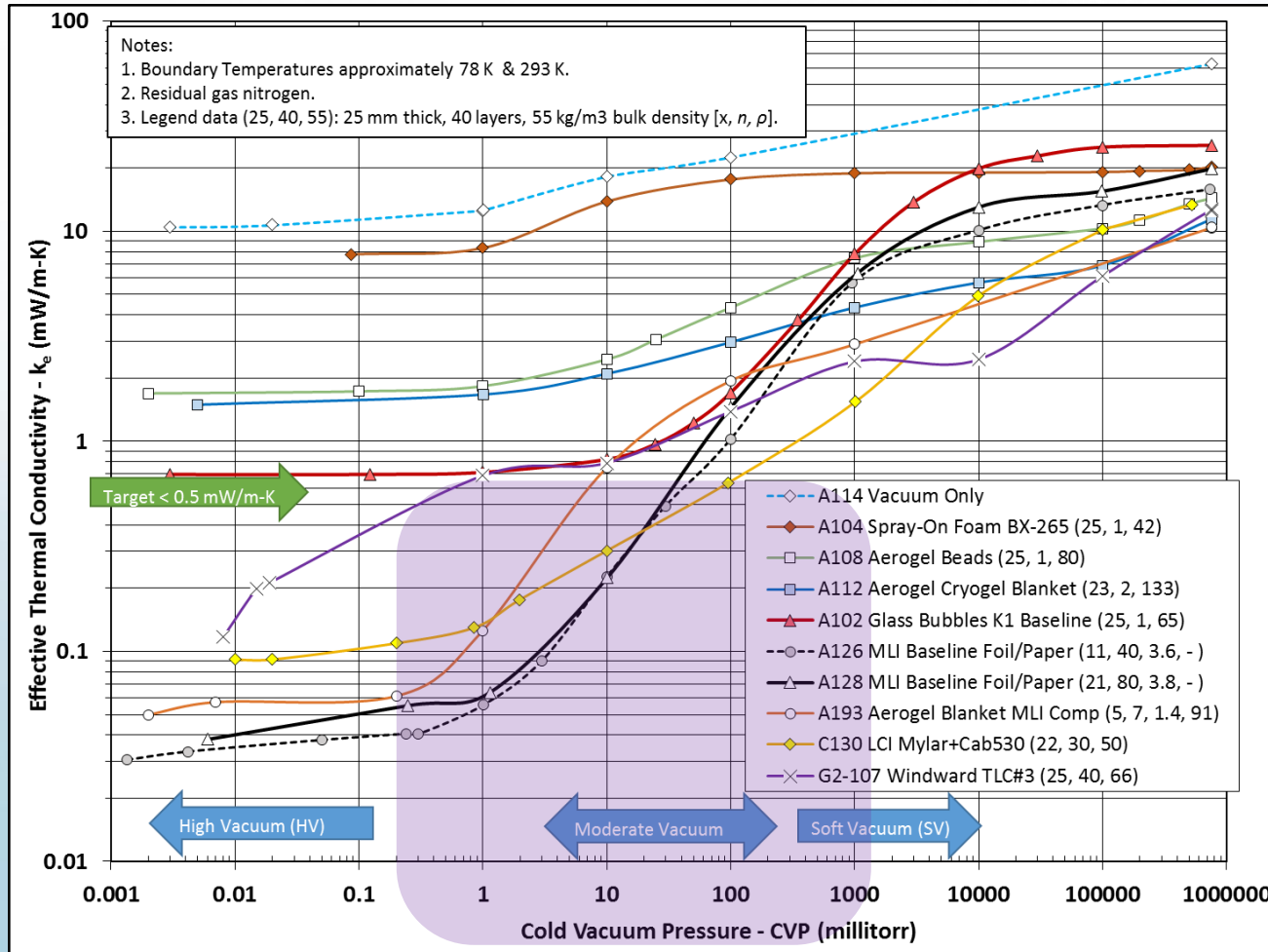

Project Goal:
 Create a moderate vacuum insulation system with low effective thermal conductivity (shaded region).



Accomplishments and Progress

Selected Cryostat Data: Insulation System Heat Flux (q)

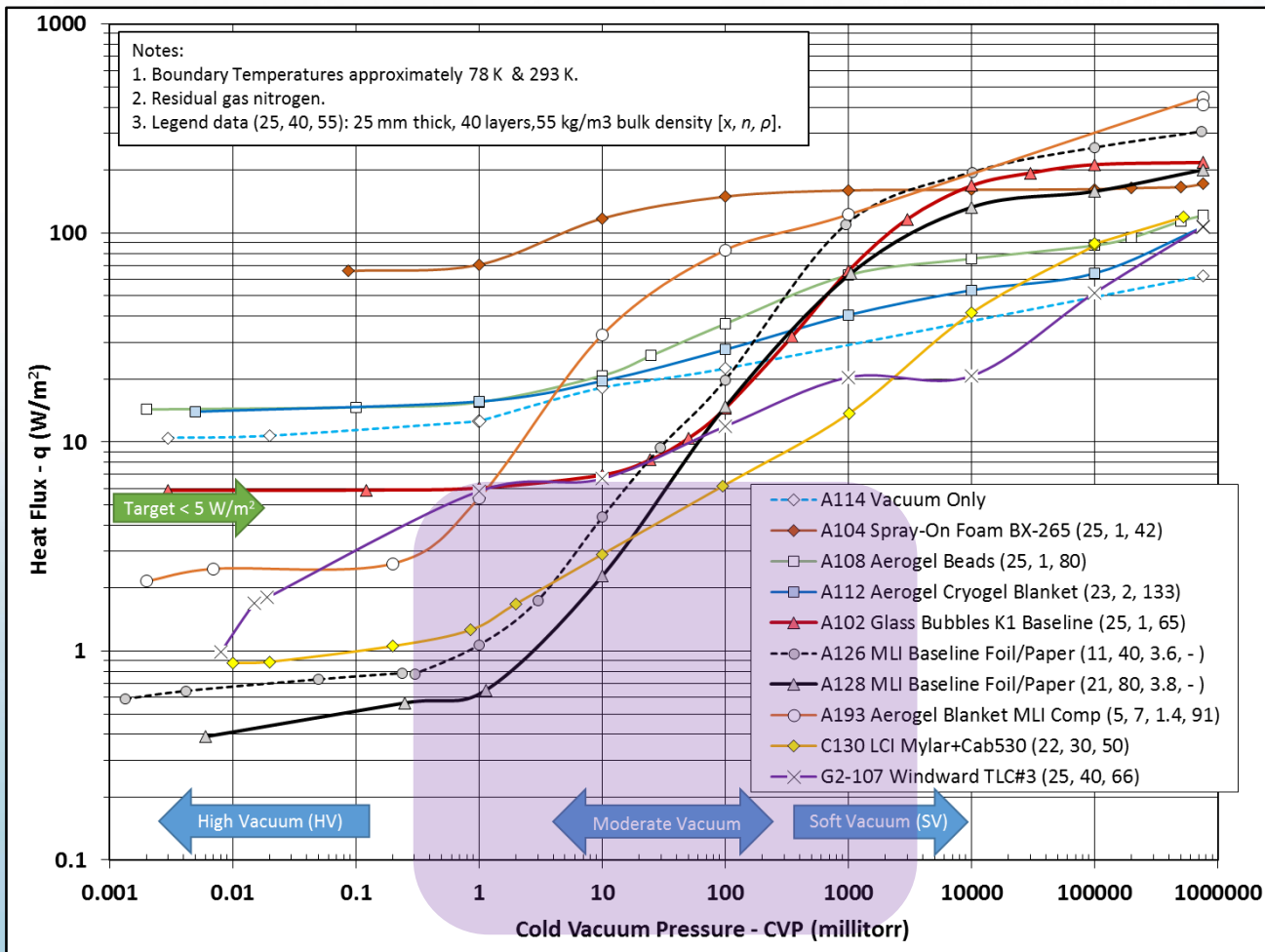

Project Goal:
 Create a moderate vacuum insulation system with a low system-level heat flux (shaded region).



Accomplishments and Progress

Vacuum Stability Testing

- Proposed standardized methodology for vacuum stability testing as part of iCAT system development
 - Multi-purpose, thermal-vacuum apparatus for testing **disk type test specimens** or **small tanks** suspended within vacuum can
 - Evacuate to baseline vacuum 10^{-6} torr level with bakeout
 - Vacuum decay over 72 hours at stable 303 K environment
 - Determine pressure rate of rise; analyze for vacuum stability
 - Can also run ASTM E595 outgassing data at 373 K
 - Side view schematic of Vacuum Stability apparatus at right
- Aspen Aerogel's five blankets test screening for down-select (Spaceloft-gray shown at right)
- Polyimide aerogel (X-aerogel) structural materials received from Flexcon/ Blueshift for preliminary thermal-structural and vacuum evaluation

Capability to test the vacuum stability of material samples as well as small vessel or prototype insulation systems.

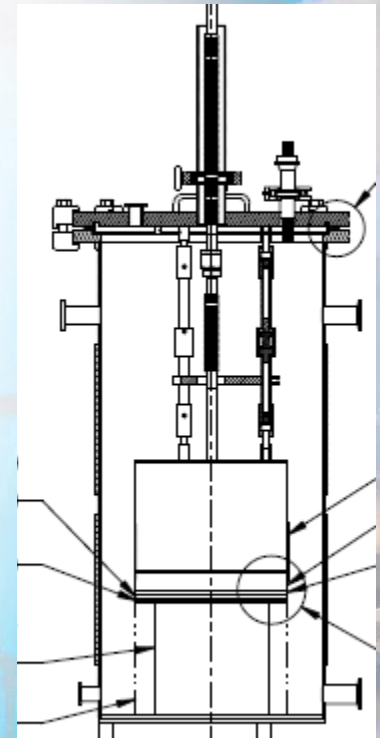

Accomplishments and Progress

Insulation Materials

- Aspen Aerogels is the worlds largest manufacturer of high performance aerogel insulation with a worldwide installed base of more than 200MM ft² (18MM m²).
- Aspen has delivered different types of commercially available (~\$2.30/ft² – \$2.75/ft²) aerogel insulation blankets for preliminary thermal performance tests, as shown in the table below:

Type	Thickness (mm)	*Thermal Conductivity ASTM C177 (mW/m-K)	Nominal Density ASTM C167 (g/cc)	Maximum Use Temperature (°C)
Spaceloft® Subsea	5 or 10	14.5	0.16	200
Spaceloft® Grey	5 or 10	16.5	0.16	200
Cryogel® x201	5 or 10	17.0	0.16	200
Pyrogel XTE	5 or 10	21	0.20	650

*Thermal conductivity at 37.5°C (100°F), 13.8 kPa (2 psi) compressive load, & atmospheric pressure.

Examining several of Aspen Aerogels' commercially available aerogel insulation blankets, ensuring that the insulation system solution is realistic and commercially viable.



Accomplishments and Progress

Composite Tanks

- Identified potential tanks for evaluation of vacuum retention/stability, permeation, outgassing, and structural-mechanical properties



Hexagon Lincoln is supplying several Type 3 and Type 4 pressure vessel options.

Accomplishments and Progress

Comparison of Tank Geometry

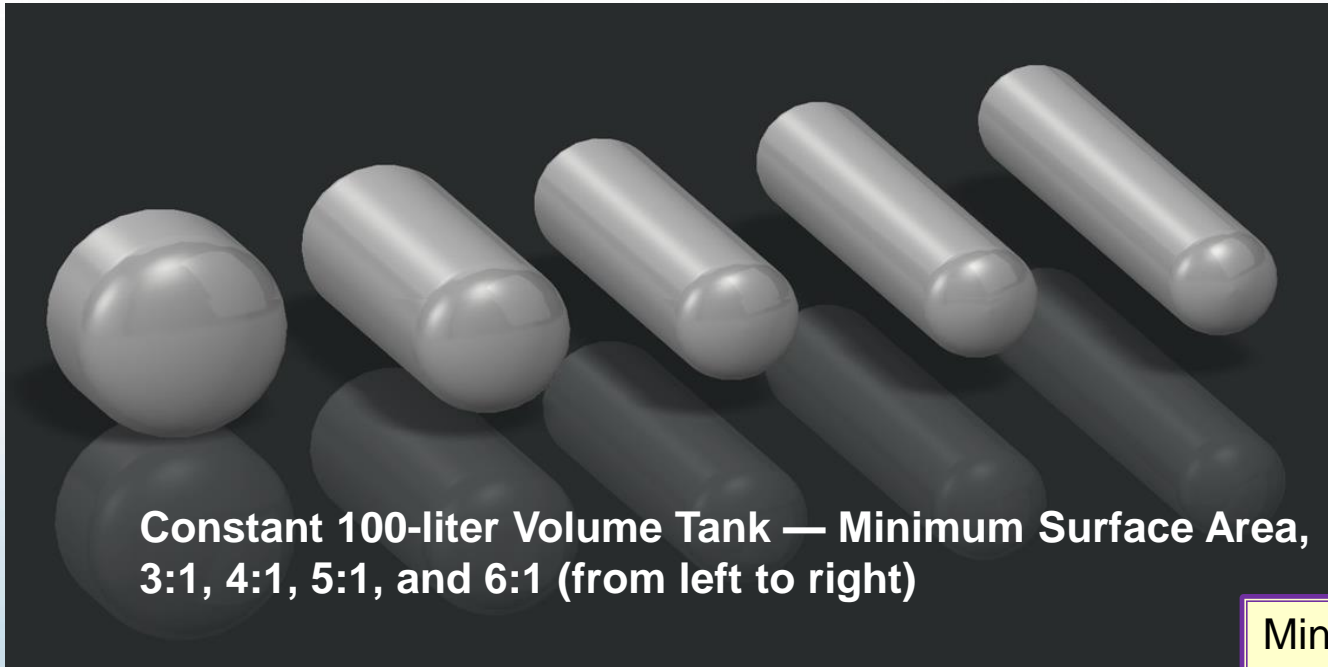

Tank	L/D	L (in)	D (in)	Approx. Surface Area (m ²)*		
				Heads	Barrel	Total
A	0.88	19.5	22	0.677	0.388	1.065
B	3	42	14	0.294	1.021	1.315
C	4	50.5	12.7	0.251	1.176	1.427
D	5	59	11.7	0.221	1.292	1.513
E	6	66	11	0.201	1.398	1.599

*Surface area assumes wall thickness of 0.2-inch

Minimum surface area does not guarantee minimum heat load.

Elliptical / hemispherical endcaps create far more defects than cylindrical sections.



Accomplishments and Progress

Cryo-compressed hydrogen storage system design

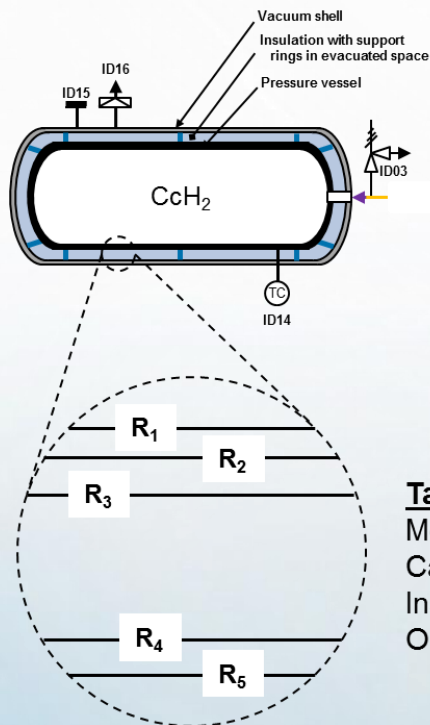

**3:1 L-to-D, 100 L
(77 K, 300 bar)**

Component	Mass [kg]	Vol [L]
Pressure Vessel	83.60	143.48
-- Aluminum liner (only)	32.44	12.18
-- Carbon fiber layer (only)	50.42	31.30
Insulation	6.16	39.54
Outer Shell	9.88	3.71
Boss, Plug, and Support Rings	0.74	0.00
Outer Tank Totals (without BOP)	99.64	186.73

Tank Layer Thicknesses:
 Metal layer/liner = R_1 to R_2
 Carbon Fiber layer = R_2 to R_3
 Insulation/supports layer = R_3 to R_4
 Outer shell = R_4 to R_5

Component	Value
Cylinder length (L_{cyl})	975.26 mm
Internal Radius (R_1)	170.95 mm
Al liner thickness ($R_2 - R_1$)	9.11 mm
CF liner thickness ($R_3 - R_2$)	21.03 mm
Insulation layer ($R_4 - R_3$)	23.00 mm
Outer Al shell ($R_5 - R_4$)	2.00 mm
Outer Diameter (D_{tank})	452.18 mm
Outer Length (L_{tank})	1256.49 mm

Hydrogen storage system designs will be used to evaluate integrated insulation system designs within the heat load / heat flux calculation models.



Remaining Challenges and Barriers

- **Thermal vs structural demands**
 - How do we balance both of these mutually exclusive parameters?
- **Composite pressure vessel outgassing**
 - How do we minimize the outgassing?
- **Vacuum level/quality**
 - What is the minimum value(s) that are acceptable and meet DOE targets?
- **Real-World vs Lab environment**
 - What is the best balance?
- **Manufacturability**
 - How to we ensure realistic manufacturing costs?
- **Fill-tube heat leak**
 - How can we minimize the fill-tube heat leak while maintaining the working pressure needed in Cryo-Compressed vessels?



Future Work*

- Milestones (End of FY17 – FY18)
 - Complete preliminary design for full-scale storage system **In-Progress**
 - Down-select potential concept technologies **In-Progress**
 - Complete initial component testing
 - Update system concept based on costs
 - Complete sub-scale concept modeling and testing
 - Down-select sub-scale concept technology
 - Complete sub-scale prototype design
- Prototype
 - Sub-scale components
 - Model
 - Insulation testing



* Any proposed future work is subject to change based on funding levels



Technology Transfer Activities

- Aspen Aerogels – Future funding opportunities for scale-up of the thin aerogel insulation if a market need is identified that is large enough to justify scale-up efforts.
- NASA.
 - LCI (Webb/Herman)*
 - X-aerogel (Flexcon/Blueshift)*



Accomplishments and Progress: Responses to Previous Year Reviewers' Comments

- This project was not reviewed last year.



Summary

- The project objective to develop an **Integrated Insulation System** for Cryogenic Automotive Tanks demonstrating the DOE 5-7 W heat leak targets for a 100 L cryogenic hydrogen storage tank using a subscale prototype insulation system.
- FY17 accomplishments to date:
 - Completed preliminary design for a full-scale cryo-compressed hydrogen storage system – Integrated insulation system preliminary design still in progress
 - Initiated data mining of 19+ years of insulation test data for screening possible insulation and support materials.
 - Received commercially available aerogel insulation blankets from Aspen Aerogel. Initiated evaluation for thermal performance.
 - Received commercially available Type 3 and Type 4 pressure vessels from Hexagon Lincoln. Initiated evaluation for vacuum retention/stability, permeation, outgassing, and structural-mechanical properties.



Special Thanks

Department of Energy:

- Jesse Adams, DOE
- John Gangloff, DOE
- Ned Stetson, DOE
- Chris Werth, DOE

Project Team:

- Donald Anton, SRNL
- David Tamburello, SRNL
- James Fesmire, NASA/KSC
- Adam Swanger, NASA/KSC
- Shannon White, Aspen Aerogels
- Duane Byerly, Hexagon Lincoln
- John Eihusen, Hexagon Lincoln
- Norm Newhouse, Hexagon Lincoln
- Mike Aller, Energy Florida
- Tim Franta, Energy Florida
- Al Sorkin, ITB, Inc



Back-Up Slides

Cryo-compressed hydrogen storage system design

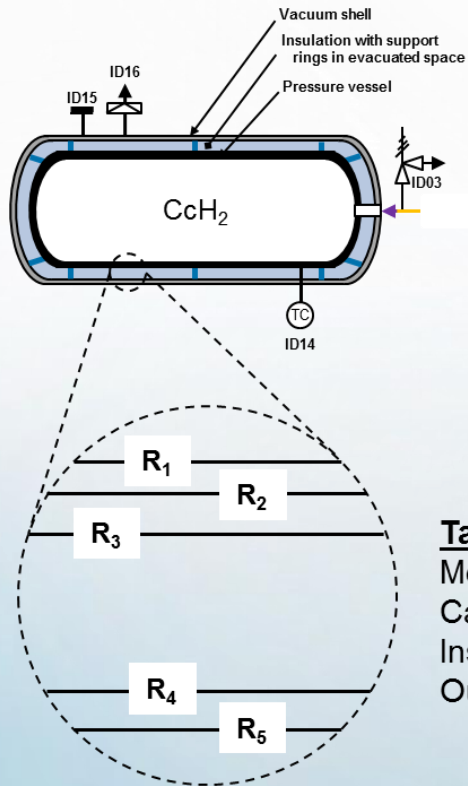

Tank Layer Thicknesses:
 Metal layer/liner = R_1 to R_2
 Carbon Fiber layer = R_2 to R_3
 Insulation/supports layer = R_3 to R_4
 Outer shell = R_4 to R_5

4:1 L-to-D, 100 L
(77 K, 300 bar)

Component	Mass [kg]	Vol [L]
Pressure Vessel	81.66	142.54
-- Aluminum liner (only)	31.55	11.85
-- Carbon fiber layer (only)	49.44	30.69
Insulation	6.44	42.45
Outer Shell	10.64	3.99
Boss, Plug, and Support Rings	0.67	0.00
Outer Tank Totals (without BOP)	98.74	188.98

Component	Value
Cylinder length (L_{cyl})	1238.57 mm
Internal Radius (R_1)	154.05 mm
Al liner thickness ($R_2 - R_1$)	8.21 mm
CF liner thickness ($R_3 - R_2$)	19.20 mm
Insulation layer ($R_4 - R_3$)	23.00 mm
Outer Al shell ($R_5 - R_4$)	2.00 mm
Outer Diameter (D_{tank})	412.93 mm
Outer Length (L_{tank})	1497.45 mm



Cryo-compressed hydrogen storage system design

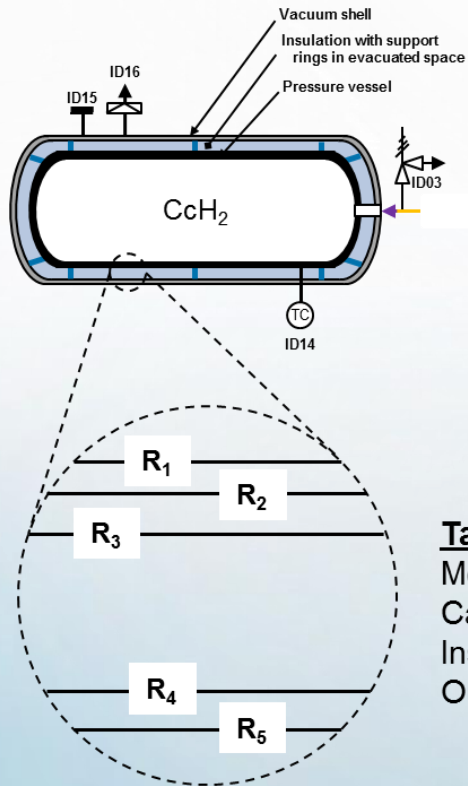

6:1 L-to-D, 100 L
(77 K, 300 bar)

Component	Mass [kg]	Vol [L]
Pressure Vessel	78.69	140.96
-- Aluminum liner (only)	30.69	11.53
-- Carbon fiber layer (only)	47.42	29.43
Insulation	7.03	47.57
Outer Shell	11.98	4.50
Boss, Plug, and Support Rings	0.57	0.00
Outer Tank Totals (without BOP)	97.97	193.02

Tank Layer Thicknesses:

Metal layer/liner = R₁ to R₂
Carbon Fiber layer = R₂ to R₃
Insulation/supports layer = R₃ to R₄
Outer shell = R₄ to R₅

Component	Value
Cylinder length (L _{cyl})	1710.52 mm
Internal Radius (R ₁)	133.01 mm
Al liner thickness (R ₂ - R ₁)	7.09 mm
CF liner thickness (R ₃ - R ₂)	16.46 mm
Insulation layer (R ₄ - R ₃)	23.00 mm
Outer Al shell (R ₅ - R ₄)	2.00 mm
Outer Diameter (D _{tank})	363.12 mm
Outer Length (L _{tank})	1940.62 mm



Accomplishments and Progress

Selected Cryostat Data

Analyzing full vacuum range cryogenic thermal performance data in two ways:

- Heat Flux (q) [example shown, right]
- Effective thermal conductivity (k_e)
- Moderate vacuum is between high vacuum and soft vacuum as shown (roughly between 3 and 300 millitorr)

Fourteen thermal insulation systems/materials selected for detailed analysis:

- Two baseline
- Six reference
- Six candidate

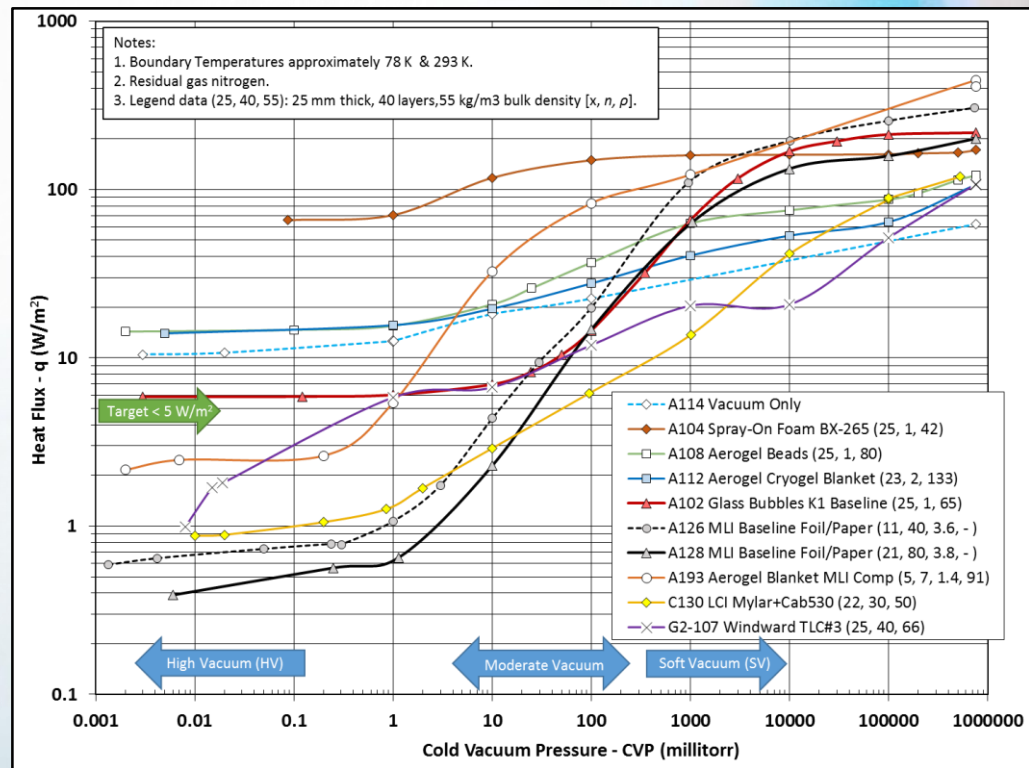

Cryostat-100 Data Series for K1 Glass Bubbles (right):

- One of 130 thermal insulation systems analyzed to date
- Baseline reference for tank heat leak analysis

Insulation Test Instrument Cryostat-100 Data Summary										NASA Kennedy Space Center, Cryogenics Test Laboratory, Florida USA									
See ASTM C740 and C1774 for detailed explanation of nomenclature and symbols. Effective length (L_e) = 0.5796 m; Cryostat-100 testing is performed per ASTM C1774, Annex A1.										Revision Date: 4/4/17									
A102 Glass Bubbles K1 Baseline (25, 1, 65)																			
Test	CVP	CBT	WBT	Flow	Q	q	k_e	x	d_o	d_i	L	A_e	n	ρ_{bulk}	ρ_{bulk}				
	μ	K	K	sccm	W	W/m^2	mW/m-K	mm	mm	mm	mm	m^2		g/cc	lbm/ft^3				
1" thick	0.003	78	292.6	494	2.047	5.87	0.695	25.40	217.90	167.10	1000	0.348	1	0.065	4.06				
3M Type K1 hollow microspheres	0.122	0.122	78	293.0	495	2.053	5.89	ΔT											
Black sleeve	1.0	1.0	78	292.9	506	2.100	6.03	K			P&H	m		z	z				
	10	10	78	293.1	585	2.424	6.96	215		24	hours	g	0.04	layers/mm	layers/in				
	25	25	78	293.3	691	2.867	8.23												
	50	50	78	293.6	875	3.628	10.4												
	100	100	78	293.8	1220	5.058	14.5												
	350	350	78	293.5	2696	11.180	32.1												
	1000	1000	78	293.0	5547	22.999	66.0												
	3000	3000	78	292.6	9795	40.616	117												
	10000	10000	78	293.3	14161	58.720	169												
	30000	30000	78	293.5	16294	67.563	194												
	100000	100000	78	292.7	17861	74.062	213												
	760000	760000	78	293.6	18308	75.916	218												

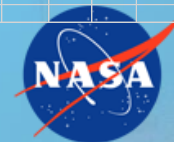

Accomplishments and Progress

Selected Cryostat Data

Insulation Test Instrument Cryostat-100 Data Summary

See ASTM C740 and C1774 for detailed explanation of nomenclature and symbols.

Effective length (L_e) = 0.5796 m; Cryostat-100 testing is performed per ASTM C1774, Annex A1.

NASA Kennedy Space Center, Cryogenics Test Laboratory, Florida USA

Revision Date: 4/4/17

A102 Glass Bubbles K1 Baseline (25, 1, 65)	Test	CVP	CBT	WBT	Flow	Q	q	k_e	x	d_o	d_i	L	A_e	n	ρ_{bulk}	ρ_{bulk}
1" thick		μ	K	K	sccm	W	W/m ²	mW/m-K	mm	mm	mm	mm	m ²		g/cc	lbm/ft ³
3M Type K1 hollow microspheres	0.003	0.003	78	292.6	494	2.047	5.87	0.695	25.40	217.90	167.10	1000	0.348	1	0.065	4.06
Black sleeve	0.122	0.122	78	293.0	495	2.053	5.89	0.696	ΔT K 215	P&H hours 24	m g 998	z layers/mm 0.04	z layers/in 1			
	1.0	1.0	78	292.9	506	2.100	6.03	0.712								
	10	10	78	293.1	585	2.424	6.96	0.821								
	25	25	78	293.3	691	2.867	8.23	0.970								
	50	50	78	293.6	875	3.628	10.4	1.23								
	100	100	78	293.8	1220	5.058	14.5	1.71								
	350	350	78	293.5	2696	11.180	32.1	3.78								
	1000	1000	78	293.0	5547	22.999	66.0	7.80								
	3000	3000	78	292.6	9795	40.616	117	13.8								
	10000	10000	78	293.3	14161	58.720	169	19.9								
	30000	30000	78	293.5	16294	67.563	194	22.9								
	100000	100000	78	292.7	17861	74.062	213	25.1								
	760000	760000	78	293.6	18308	75.916	218	25.7								



Thin, Flexible Aerogel Physical Properties

- Thin, flexible aerogel composites under development at Aspen Aerogels.
 - Designed to maintain low thermal conductivities at temperatures ranging from -150 to 200 °C.
 - MTM-01 was optimized for vacuum applications.

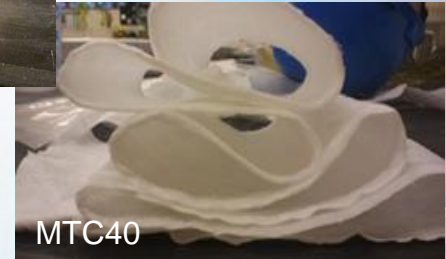
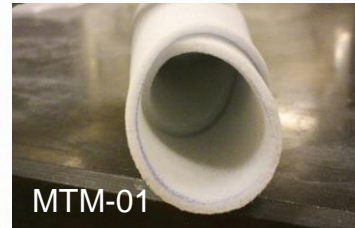

Type	Thickness (mm)	Thermal Conductivity ASTM C177 (mW/m-K)	Nominal Density ASTM C167 (g/cc)	Max. Use Temperature (°C)	Outgassing ASTM E595
MTC40	0.6 or 1.8	16.9*	0.10 – 0.15	<125	TML < 1%, VCM < 0.1%
MTM-01	2.5 - 12	3.7**	0.04 – 0.07	200	
CGM-01	2.5 - 12	13.1*	0.12 – 0.14	200	
CGP-02	2.5 -12	14.2*	0.14 – 0.16	125	

*Thermal conductivity at 0°C (32°F), 13.8 kPa (2 psi) compressive load, & atmospheric pressure.

Thermal conductivity at a mean temperature of 0°C (32°F) & **vacuum = 10⁻⁴ torr.