

# Temporal Evolution of the Plasma Sheath Surrounding Solar Cells in Low Earth Orbit

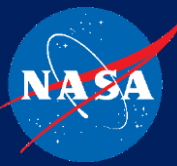

Image Credit: NASA

Emily M Willis and Maria Z. A. Pour



# Outline



- Solar Array Operations Overview
- Standard ISS Floating Potential Observations
- Transient ISS Floating Potential Observations
- Particle in Cell Simulation
- Lumped Element Model
- Conclusion and Forward Work

# Solar Array Operations Overview

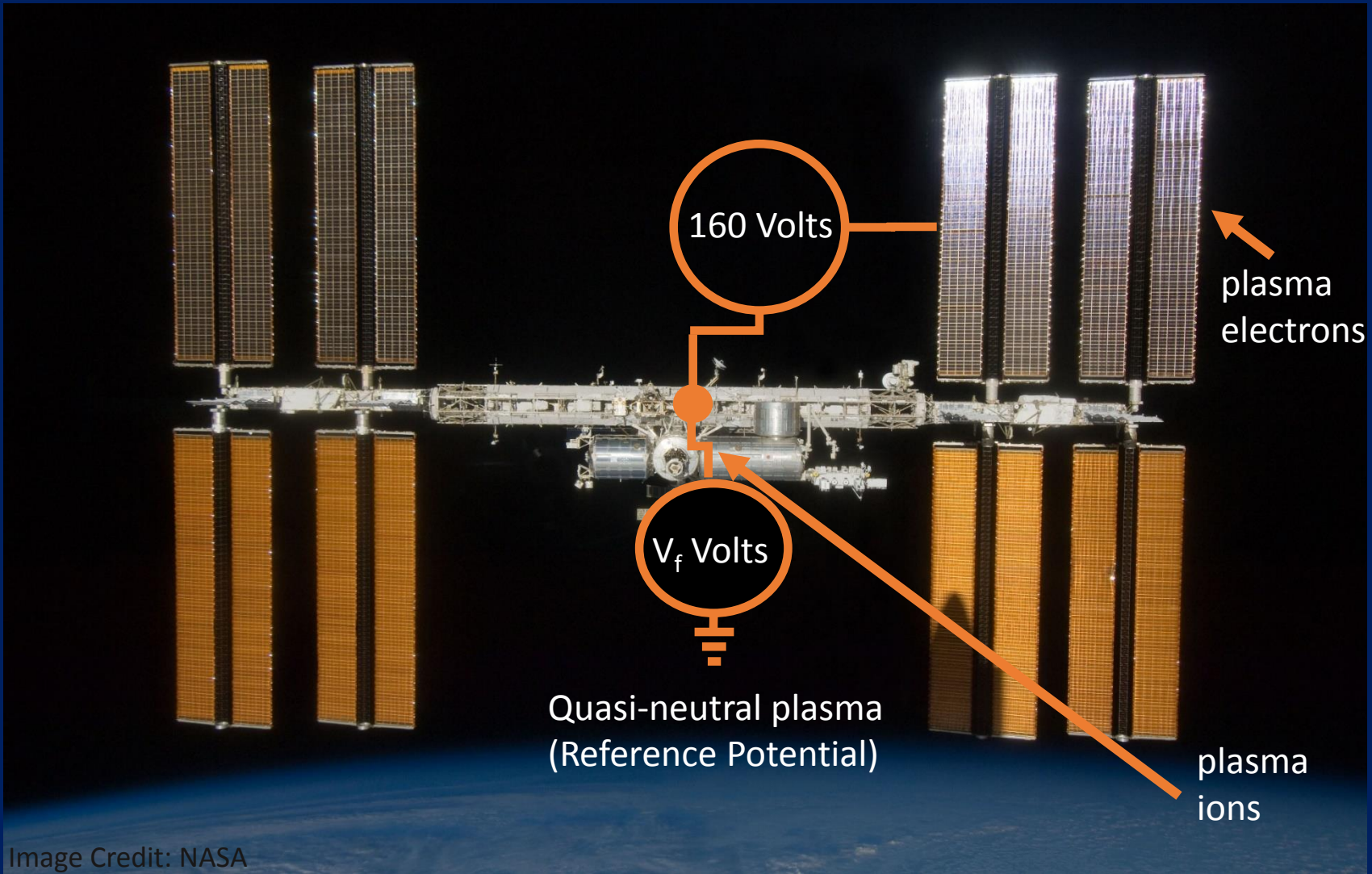
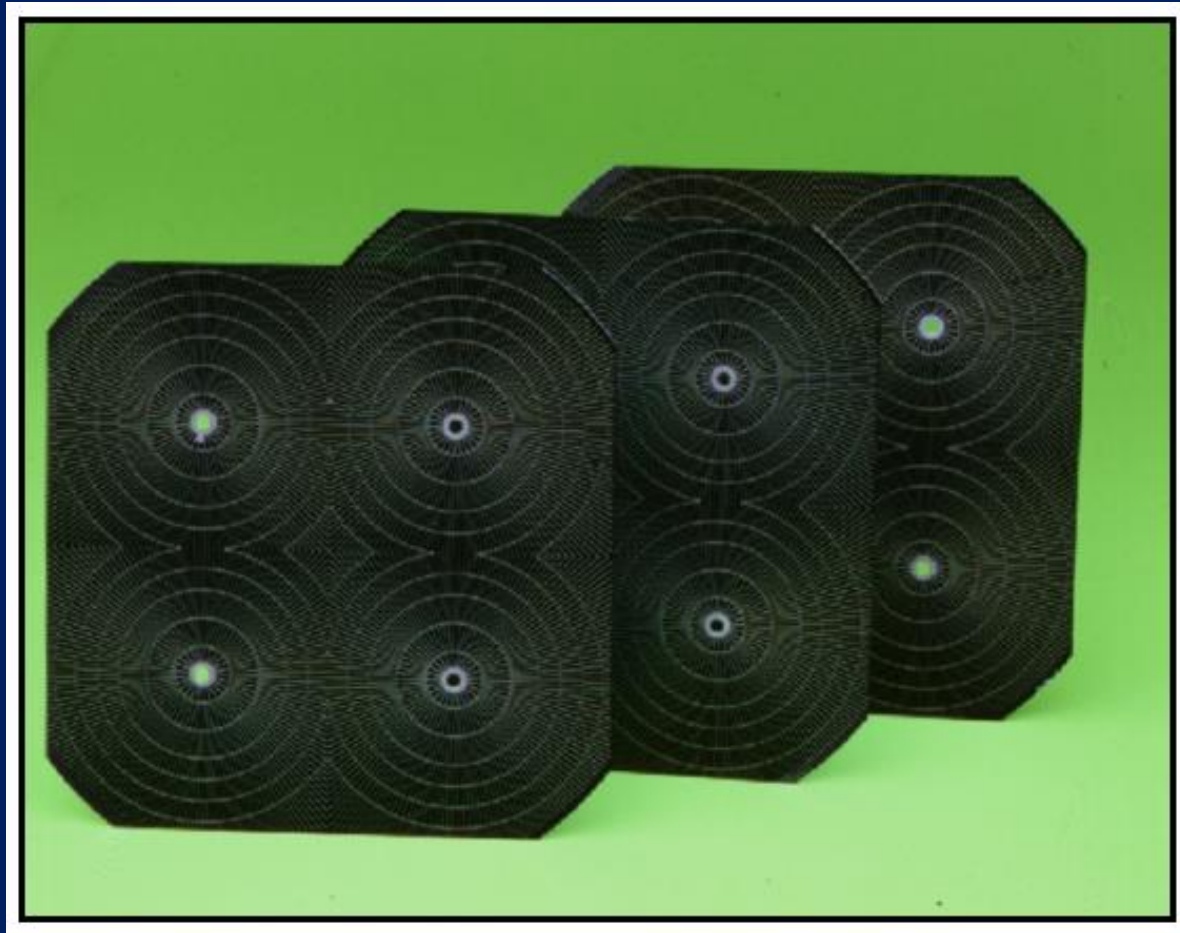

Image Credit: NASA

$V_f$  is the floating potential of the ISS

# Solar Cells



8 cm x 8 cm

plasma electrons

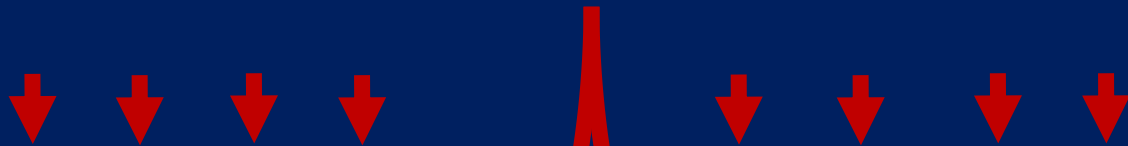

coverglass

coverglass

Silicon (160 Volts)

Silicon (160 Volts)

Kapton

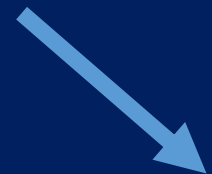

coverglass

coverglass

Silicon ( $160 - V_f$  Volts)

Silicon ( $160 - V_f$  Volts)

Kapton

# Normal

a) Floating Potential →

b) Active Array Strings →

c) Array Orientation →

d) Plasma Density →

e) ISS Latitude →

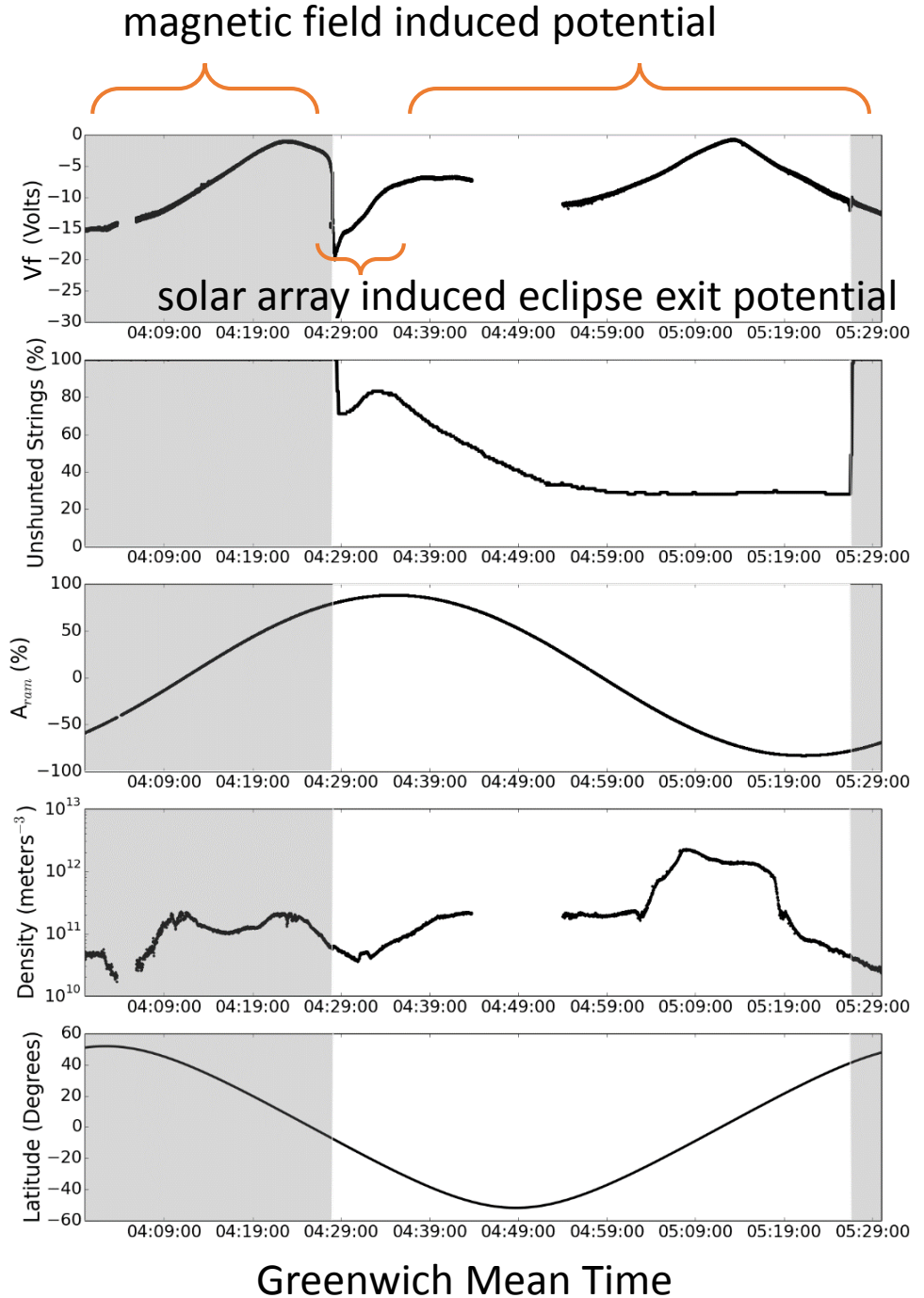

# Transients

a) Floating Potential →

b) Active Array Strings →

c) Array Orientation →

d) Plasma Density →

e) ISS Latitude →

Each of eight arrays

unshunted in full sunlight

close-up

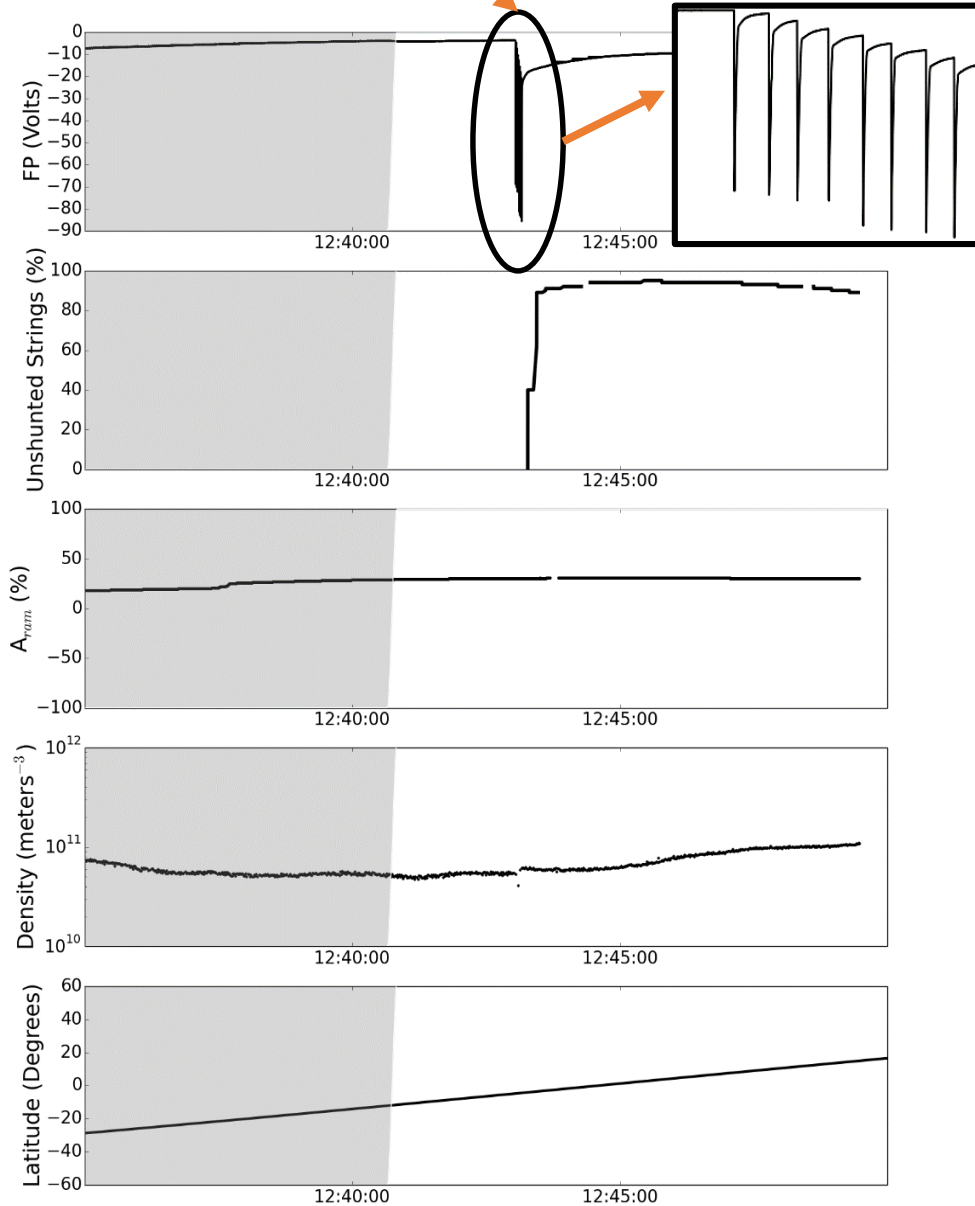

Greenwich Mean Time

# Transients

a) Floating Potential →

b) Active Array Strings →

c) Array Orientation →

d) Plasma Density →

e) ISS Latitude →

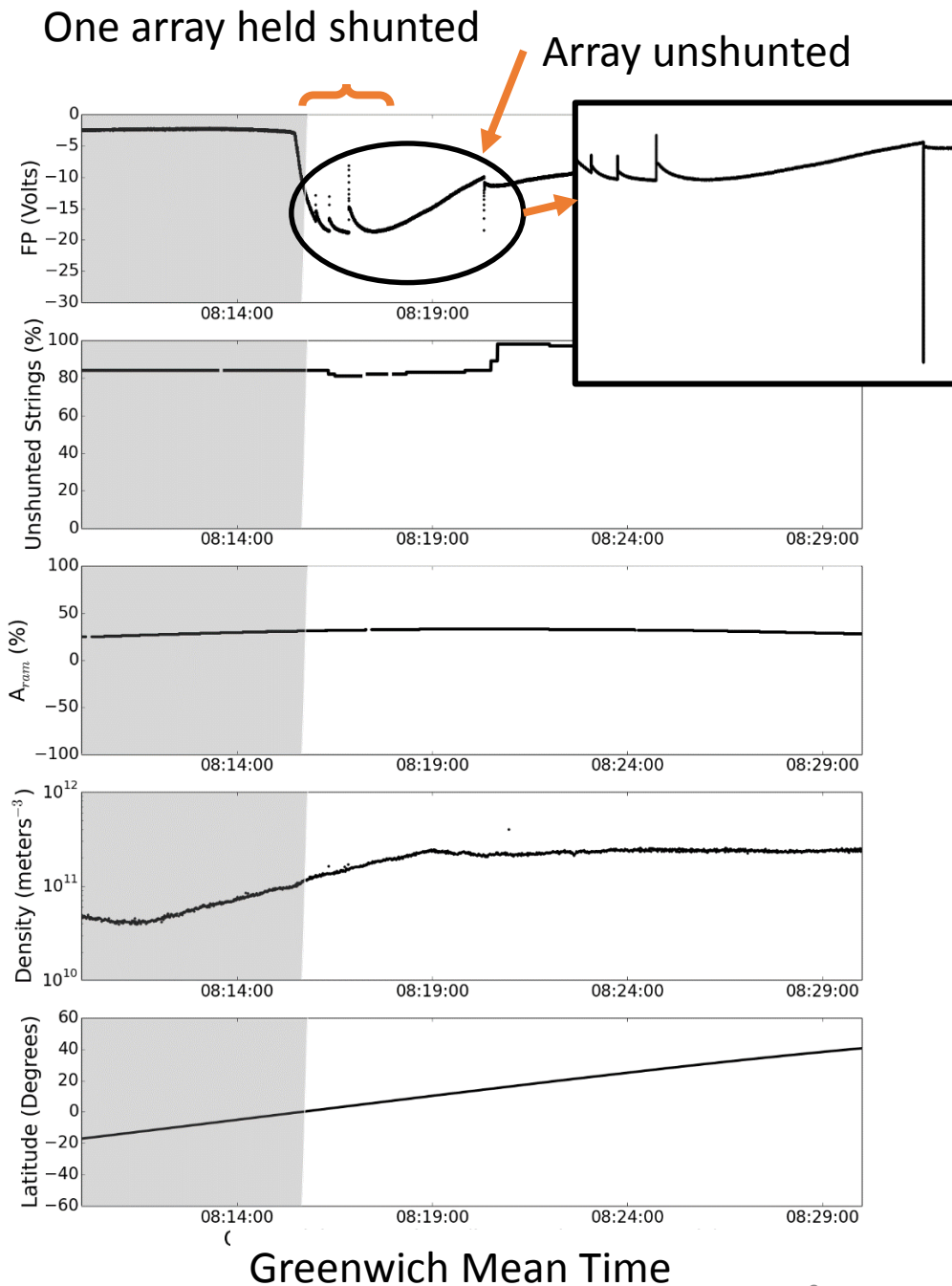



# Transients

a) Floating Potential →

b) Active Array Strings →

c) Array Orientation →

d) Plasma Density →

e) ISS Latitude →

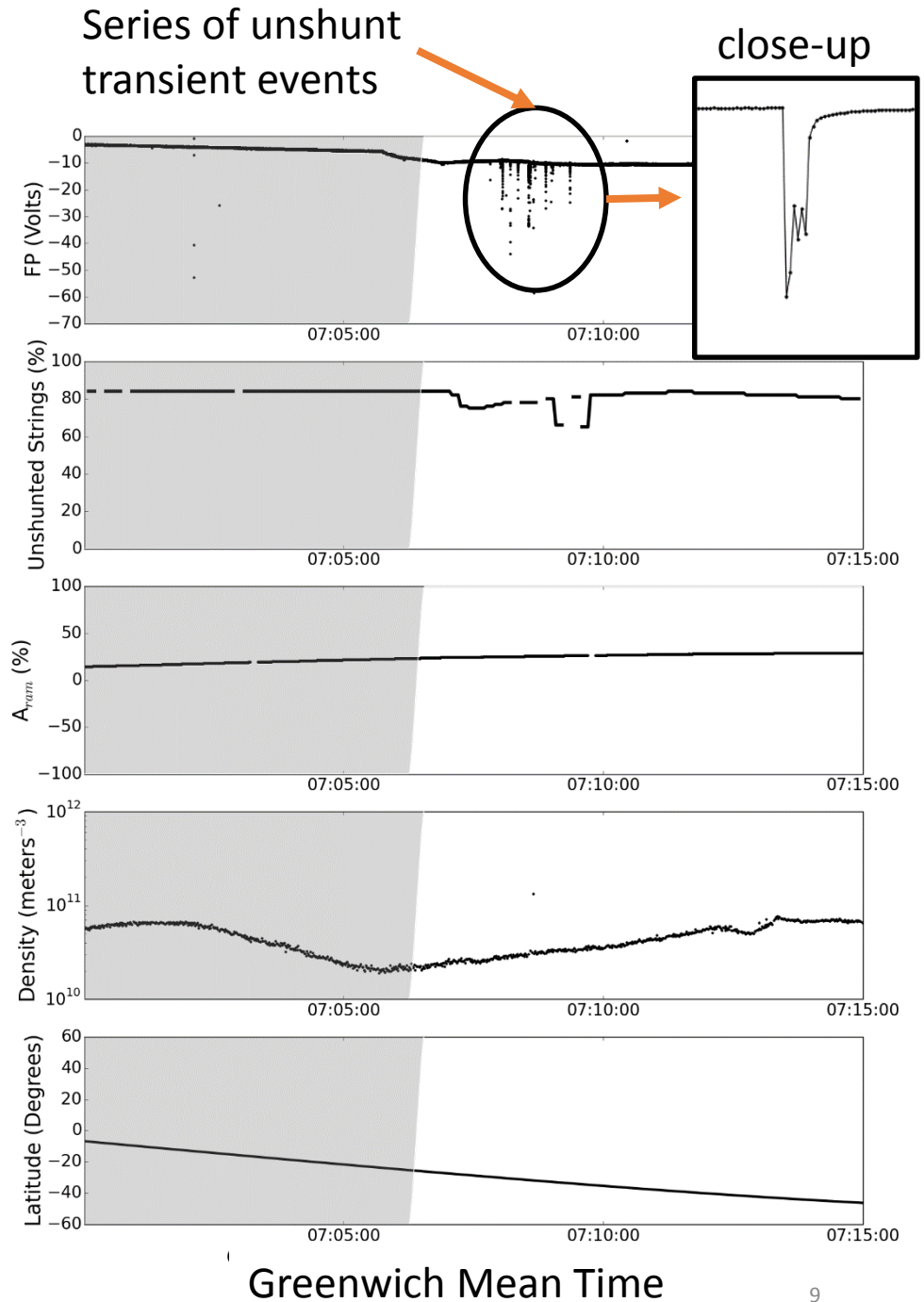

# SPIS Setup – Steady State

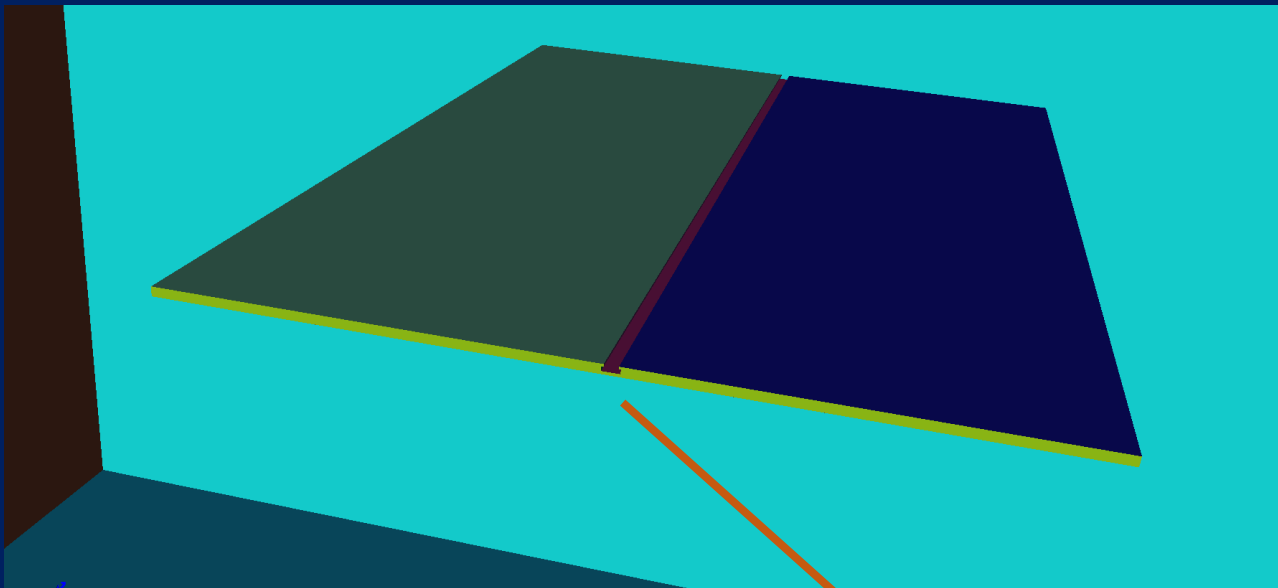

Coverglass surface set to  $-0.2$  Volts.  
Solar Cell set to 150 Volts  
Plasma Density  $1E11 \text{ m}^{-3}$   
Plasma Temperature  $0.1\text{eV}$   
Cell area  $2 \text{ cm} \times 4 \text{ cm}$   
Cell spacing  $0.8\text{mm}$   
Coverglass overhang  $0.2\text{mm}$

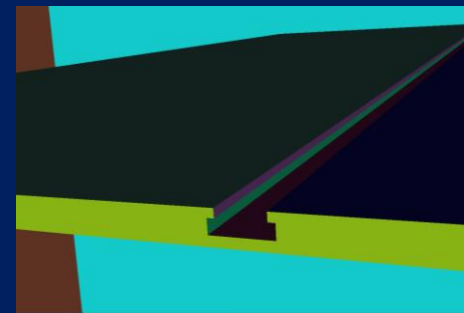

# SPIS Results for 150 V Cell at Steady-state

barrier to electron  
collection of  
of -0.07V at 6mm  
from the gap.

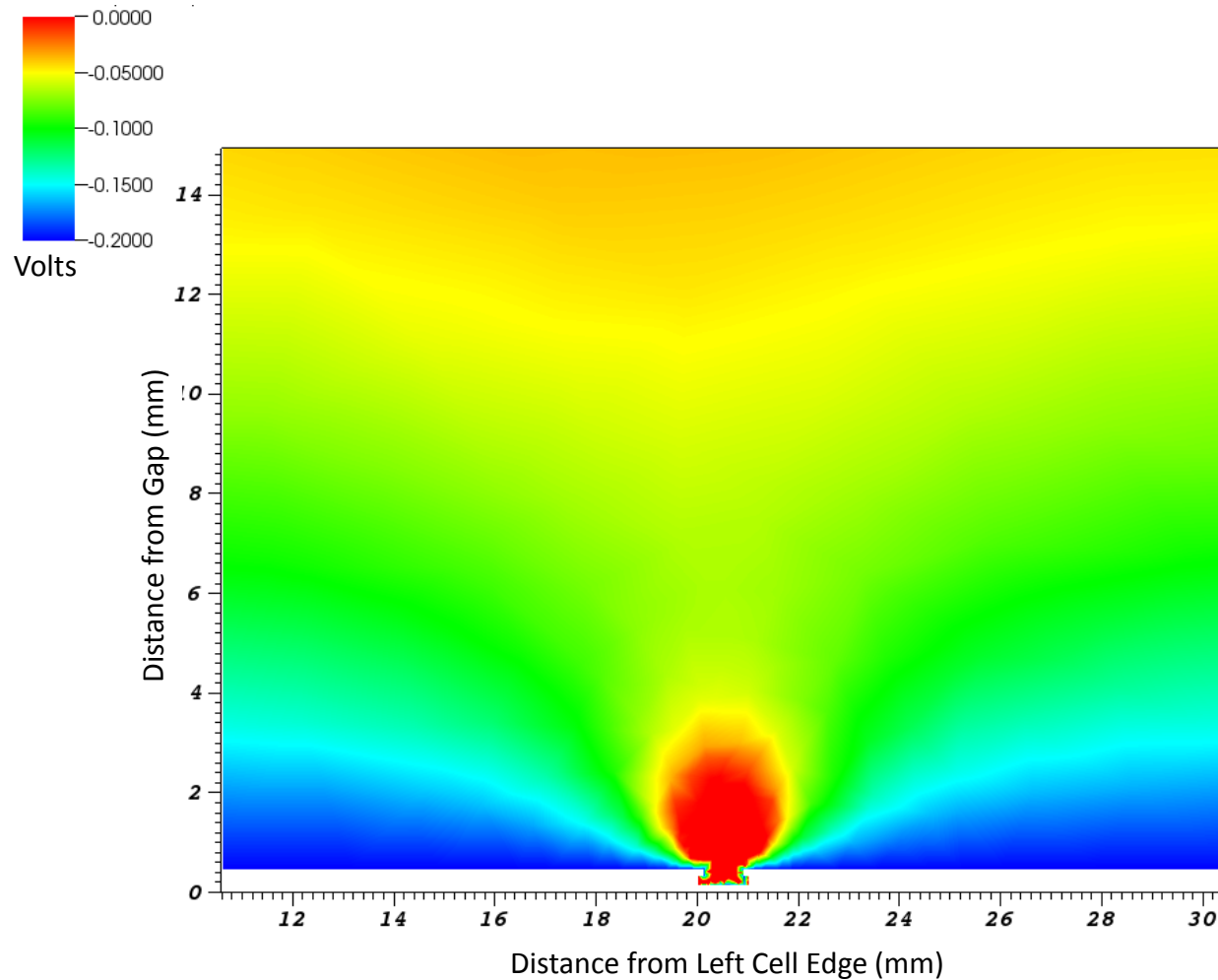

# SPIS Results for 50 V Cell at Steady-state

barrier to electron collection of -0.12V at 3mm from the gap.

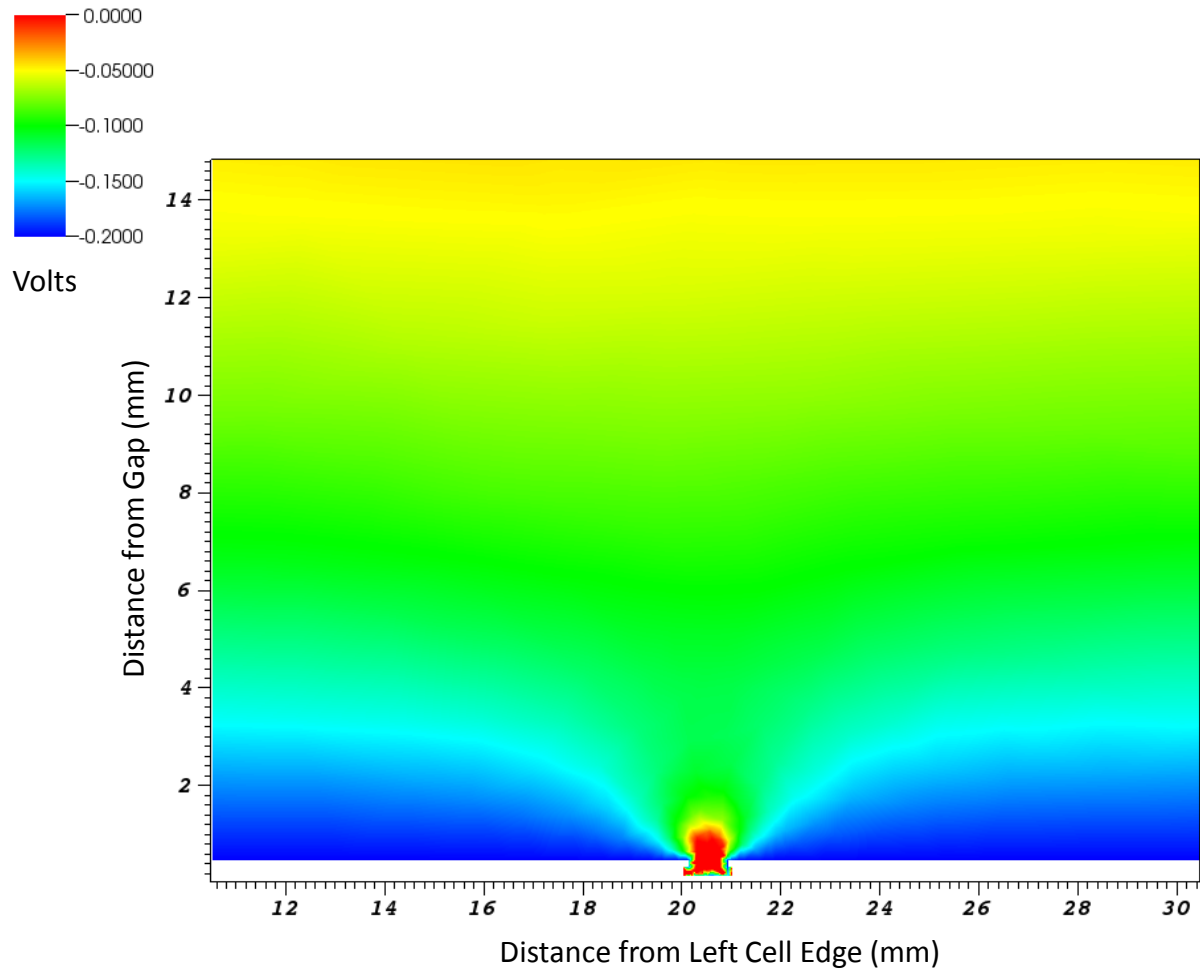

# Existing Current Balance Model for Rapid Charging<sup>1-2</sup>

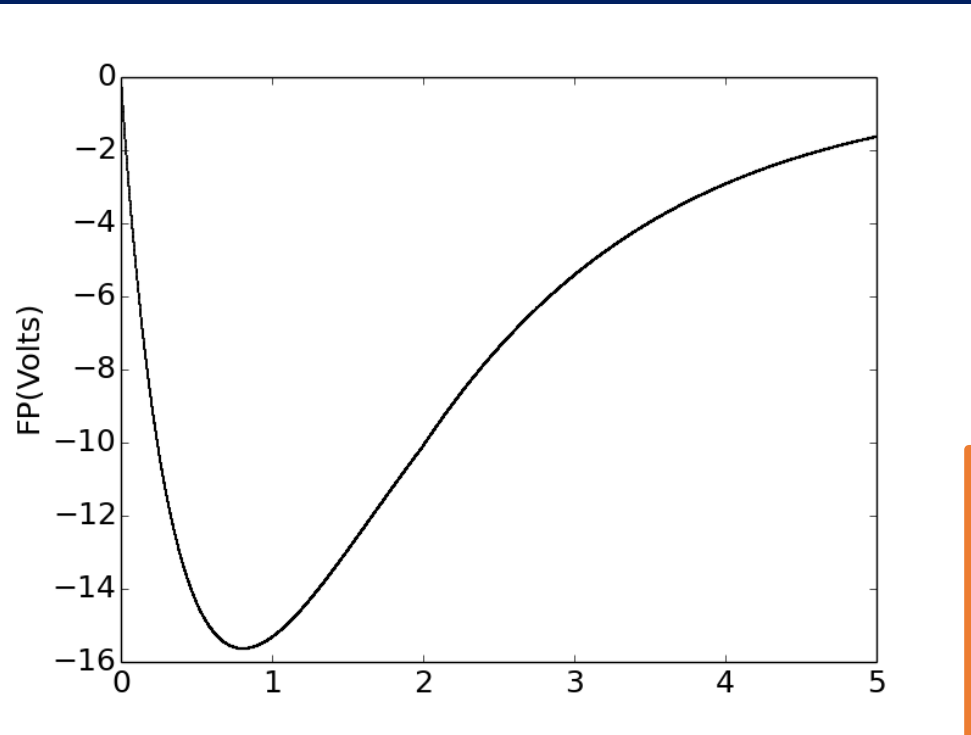

← Model Output

FPMU Data

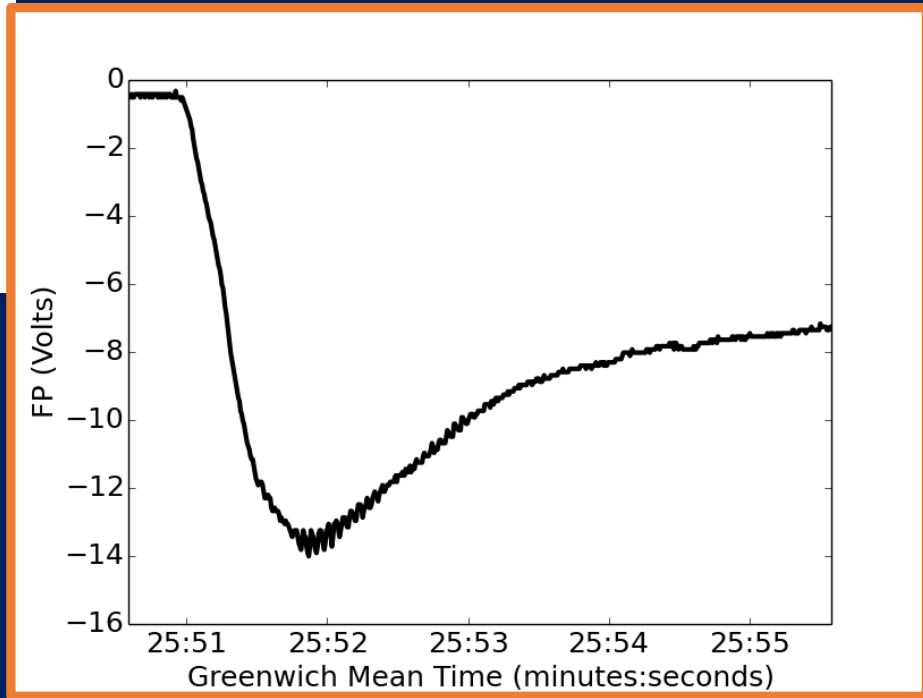

Model output agrees well with FPMU data

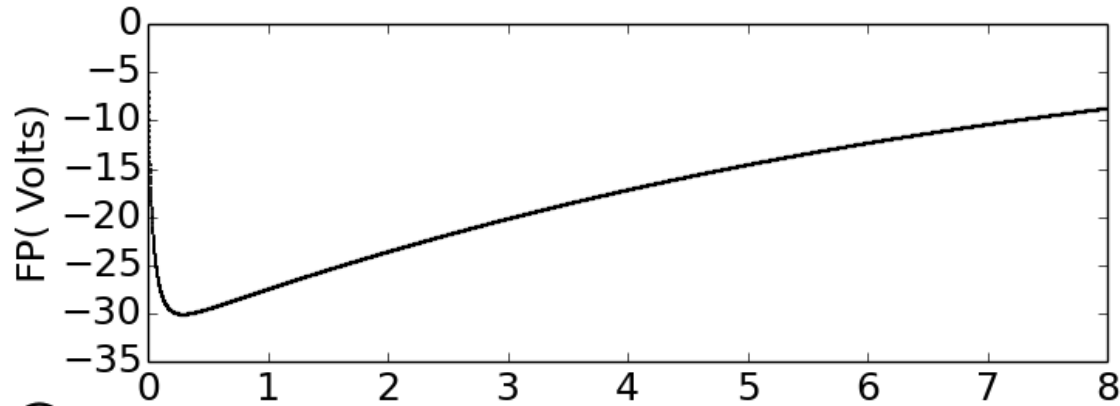

← Model Output  
FPMU Data

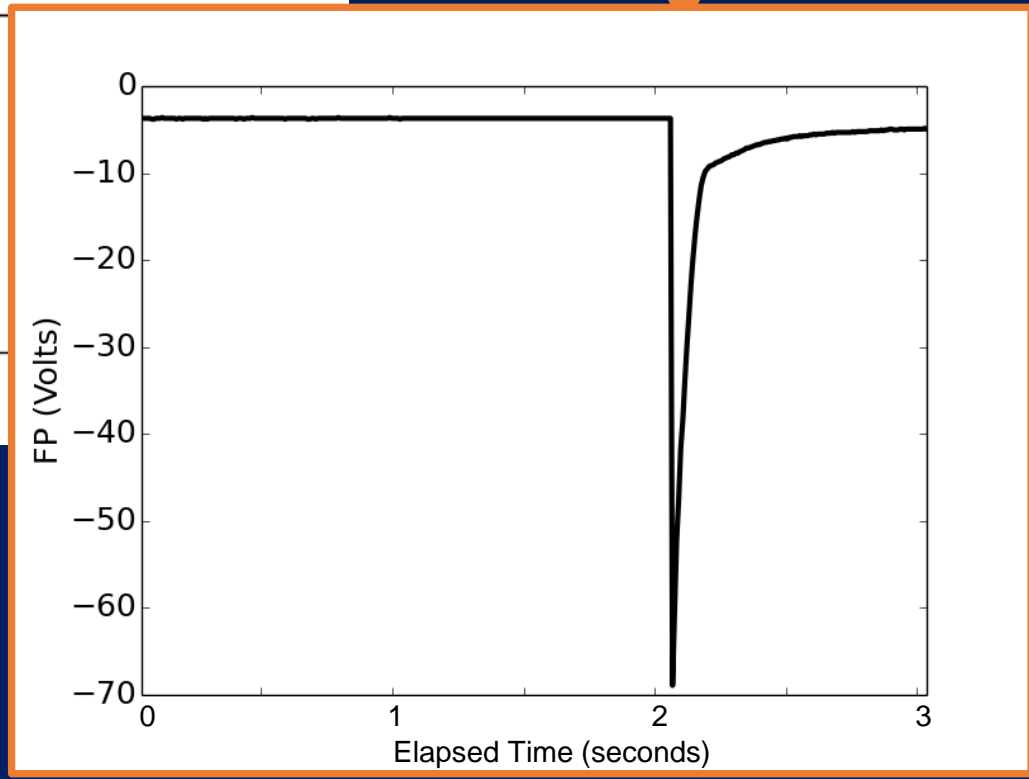
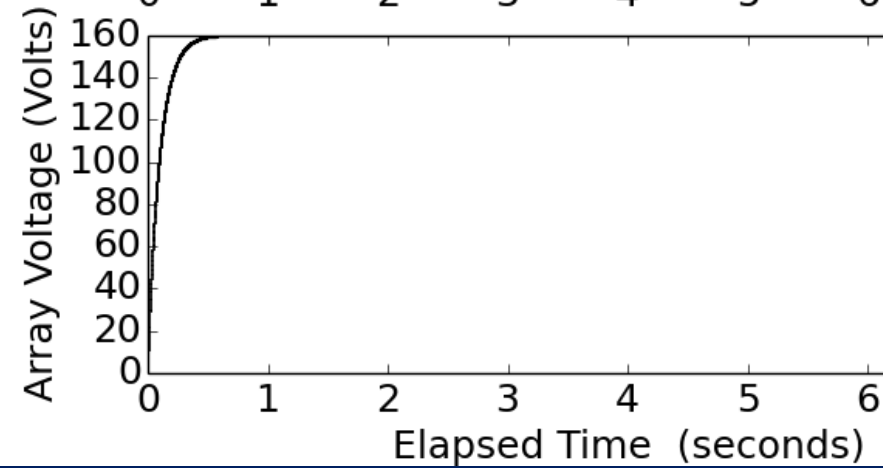

Model output does not reproduce FPMU data

# New Lumped Element Model Design

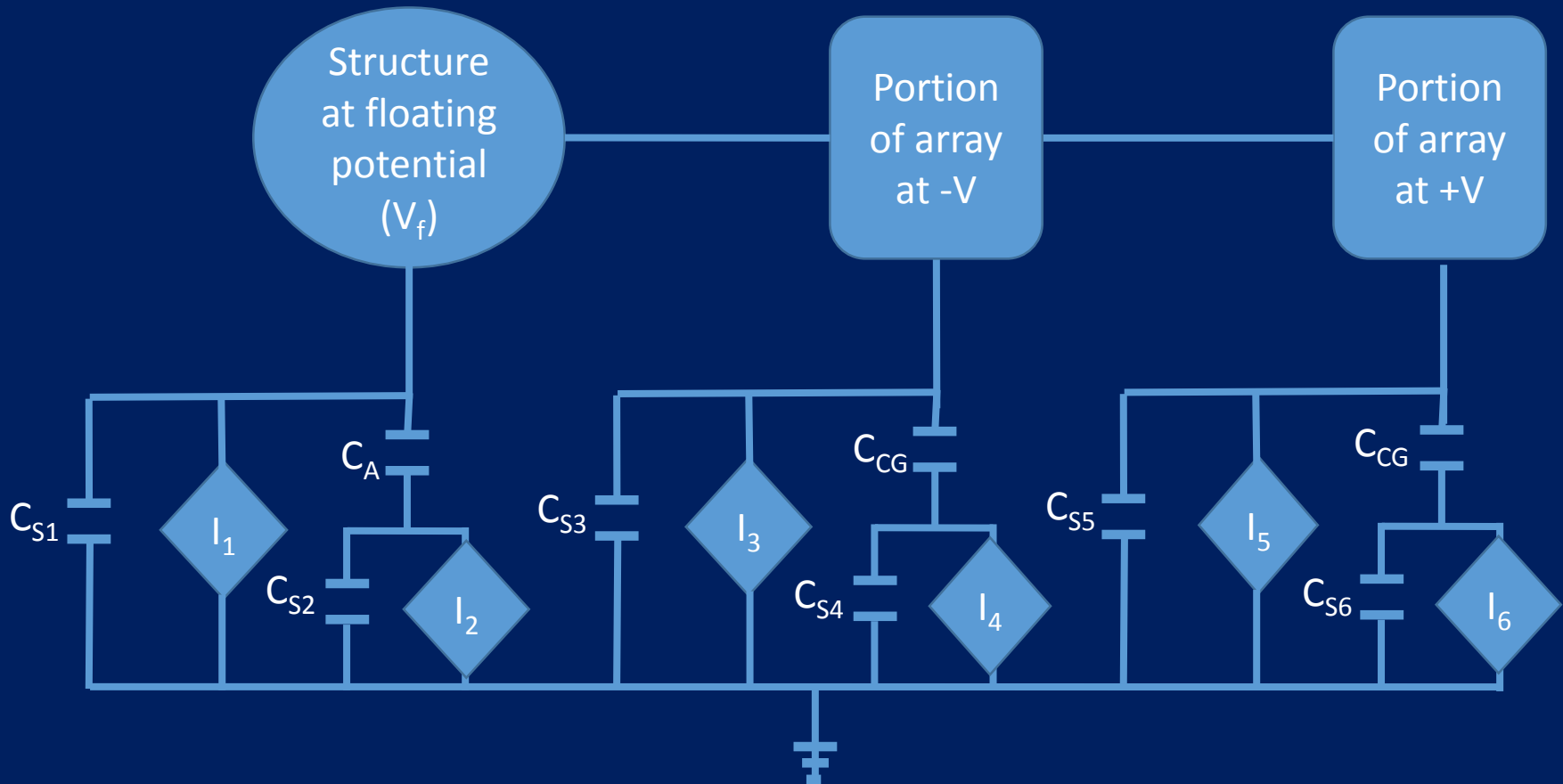

# Initial LEM Results

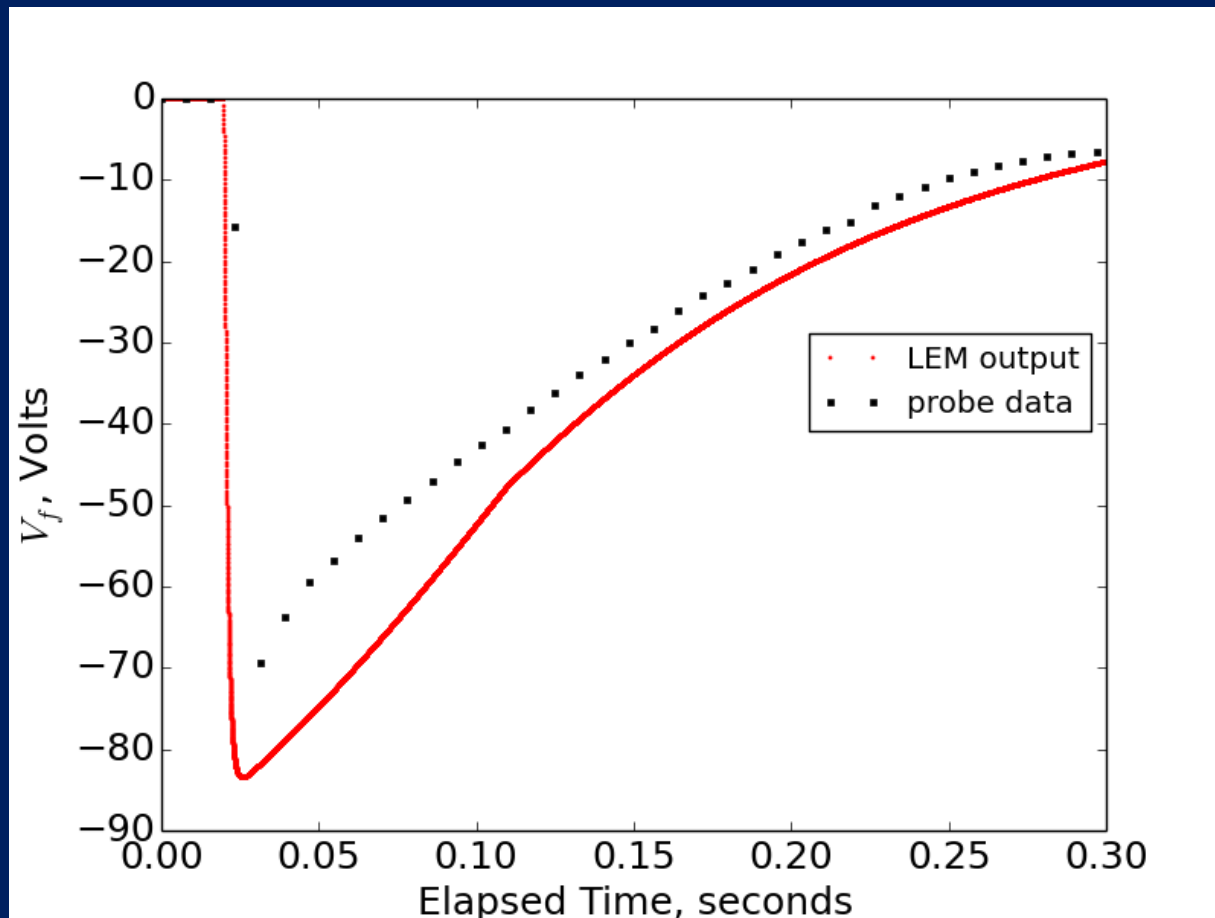

Model output agrees well with FPMU data



- Floating potential transients attributed to solar array operations have been observed in ISS FPMU data.
- These transients are not reproduced by existing current balance models, therefore a more accurate model of the current collection is needed.
- This research is investigating the time dependent development of the barrier potential. The questions to answer include:
  - How long does it take for the barrier to develop?
  - How does the current collection develop in time along with the choking effect?
- These questions will be answered by:
  - Particle In Cell simulation of a unit ISS solar cell using parameters consistent with LEO and ISS operations.
  - Evaluation of the results of the PIC simulation to determine if it is possible that the electron collection to the solar cells can account for the transient observations.

# References

- [1] J. Huang, Z. Yi, H. Zhao, L. Meng, and Y. Liu, “Model for rapid-charging events for the International Space Station, ”Journal of Spacecraft and Rockets, vol. 51, no. 1, pp. 11-15, 2014.
- [2] J. Huang, Z. Yi, H. Zhao, L. Meng, and Y. Liu, “Mechanism for rapid charging events on International Space Station,“ Journal of Spacecraft and Rockets, vol. 51, no. 3, pp. 917-921, 2014.