

# Overview of NASA Electrified Aircraft Propulsion Research for Large Subsonic Transports

Ralph H. Jansen,<sup>1</sup> Dr. Cheryl Bowman,<sup>2</sup> Amy Jankovsky,<sup>3</sup> Dr. Rodger Dyson,<sup>4</sup> and James Felder<sup>5</sup>  
*NASA Glenn Research Center, Cleveland, Ohio, 44135*

NASA is investing in Electrified Aircraft Propulsion (EAP) research as part of the portfolio to improve the fuel efficiency, emissions, and noise levels in commercial transport aircraft. Turboelectric, partially turboelectric, and hybrid electric propulsion systems are the primary EAP configurations being evaluated for regional jet and larger aircraft. The goal is to show that one or more viable EAP concepts exist for narrow-body aircraft and mature tall-pole technologies related to those concepts. A summary of the aircraft system studies, technology development, and facility development is provided. The leading concept for midterm (2035) introduction of EAP for a single-aisle aircraft is a tube and wing, partially turboelectric configuration NASA Single-Aisle Turboelectric Aircraft With Aft Boundary Layer (STARC-ABL); however, other viable configurations exist. Investments are being made to raise the technology readiness level of lightweight, high-efficiency motors, generators, and electrical power distribution systems as well as to define the optimal turbine and boundary-layer ingestion systems for a midterm tube and wing configuration. An electric aircraft power system test facility (NASA Electric Aircraft Testbed (NEAT)) is under construction at NASA Glenn Research Center and an electric aircraft control system test facility (Hybrid Electric Integrated System Testbed (HEIST)) is under construction at NASA Armstrong Flight Research Center. The correct building blocks are in place to have a viable large-plane EAP configuration tested by 2025 leading to entry into service in 2035 if the community chooses to pursue that goal.

## I. Introduction

NASA is investing in Electrified Aircraft Propulsion (EAP) research to improve the fuel efficiency, emissions, and noise levels in commercial transport aircraft as part of the Advanced Air Transportation Technologies project portfolio. The research investment includes aircraft systems, electrical power systems, component materials, and test facilities plus exploratory investment in turbine-generator interactions and boundary-layer ingestion validation. The goals of the project are to show that one or more viable EAP concepts exist for narrow-body aircraft and to advance crucial technologies related to those concepts. Viability in this context implies that concept of operation benefits have been identified for fuel burn, energy consumption, emissions, and noise metrics. Reasonable development approaches for key technologies have been identified.

The evolution of NASA's approach to EAP for large commercial aircraft is depicted in Fig. 1. The central focus had been on 2045 concepts such as the 300-passenger N3-X, which combined a number of advanced technologies including a blended wing body fuselage and a 50-MW fully distributed turboelectric propulsion system to achieve long-term fuel burn reduction goals. The rapid technology advancements in automotive and marine vehicle sectors have indicated that EAP for large aircraft may be achievable in a nearer timeframe (2035). Yet the long-term goal remains for highly advanced systems such as the N3-X. The Single-Aisle Turboelectric Aircraft With Aft Boundary Layer (STARC-ABL) propulsor concept shown in Fig. 1 is a 3-MW partially turboelectric configuration based on a tube and wing design with a motor-driven tail cone thruster. STARC-ABL has more moderate fuel burn benefits and carries fewer passengers for a typical mission, when compared to N3-X, but does not rely as heavily on technology, manufacturing, and airport infrastructure advances. A substantial effort in enabling research and development (R&D),

---

<sup>1</sup> Electrical Engineer, Aeronautics Mission Office, 21000 Brookpark Road, MS 162-3, AIAA Member

<sup>2</sup> Materials Engineer, High Temperature and Smart Alloys Branch, 21000 Brookpark Road, MS 49-1, AIAA Member

<sup>3</sup> Electrical Engineer, Aeronautics Mission Office, 21000 Brookpark Road, MS 162-3, AIAA Member

<sup>4</sup> Thermal Engineer, Thermal Energy Conversion Branch, 21000 Brookpark Road, MS 301-2

<sup>5</sup> Propulsion System Analyst, Propulsion Systems Analysis Branch, 21000 Brookpark Road, MS 5-11, AIAA Member

ground testing, and flight testing is envisioned with the goal of making entry into service possible in the 2035 timeframe for these more modest concepts.

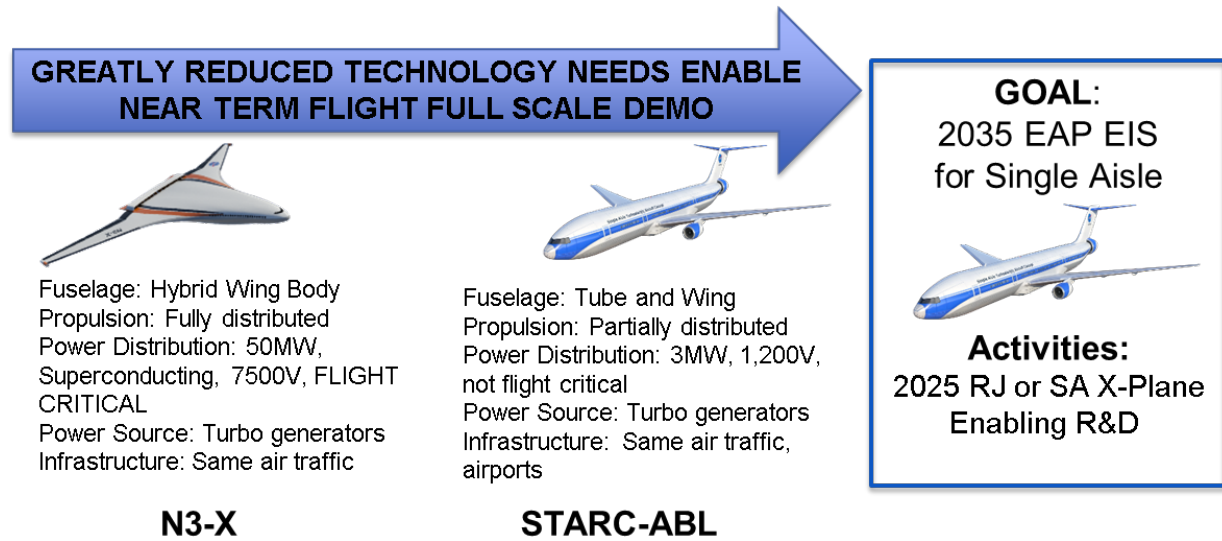

Figure 1. NASA evolution of thought for large planes.

## II. Transport Class Electrified Aircraft Propulsion Configurations

A number of EAP aircraft configurations have been explored through a combination of industry, academia, other Government agencies, and NASA studies. The configurations for regional jets and larger aircraft generally fall into three powertrain (electric drive plus propulsion) categories: partially turboelectric, fully turboelectric, and hybrid electric (Table 1). Additionally, the enhanced design freedom brought upon by electrification spawns some interesting perturbations. As an example, many of the partially turboelectric or fully turboelectric concepts can also utilize mild hybridization to allow electric taxiing or other relatively low energy parts of the mission to be accomplished with electrically stored energy. Table 1 summarizes major NASA-sponsored concepts for electrified vehicles. These vehicle concepts are differentiated by the distribution approach, the number of motor-driven propulsors, and the fraction of the total propulsive power that is provided electrically.

Table 1. Electrified Aircraft Propulsion (EAP) aircraft configurations

Study	Pax	Speed, Mach	Airframe	EAP	Electrical power, MW	Propulsion
NASA STARC-ABL	154	0.8	Tube and wing	Partial turboelectric	2 to 3	2 turbofans and 1 aft motor-driven fan
Boeing SUGAR Freeze	154	0.7	Tube and truss brace wing	Partially turboelectric (fuel cell)		2 turbofans and 1 aft motor-driven fan
NASA N3-X	300	0.84	Hybrid wing body	Turboelectric	50	16 aft motor-driven fans
ESAero ECO-150	150	0.7	Tube and split wing	Turboelectric		16 wing motor-driven fans
Boeing SUGAR Volt	154	0.7	Tube and truss brace wing	Parallel hybrid electric	1.3 or 5.3	2 motor-assisted turbofans
Rolls-Royce	154	0.7	Tube and wing	Parallel hybrid electric	1 to 2.6	2 motor-assisted turbofans
UTRC	154	0.7	Tube and wing	Parallel hybrid electric	2.1	2 motor-assisted turbofans

Turboelectric or partially turboelectric systems store all energy in fuel and convert some or all of it to electrical power to drive propulsors. Hybrid electric systems store a portion of the energy in fuel and the remainder in a battery or equivalent energy storage system with a wide range of possible implementations. One promising hybrid powertrain option is called parallel hybrid, uses both mechanical energy from the turbine and electrical energy from a motor to drive the fan, and has been considered in several studies. Parallel hybridization of an in-line turbine engine does not

offer inherent aerodynamic improvement; however, it may offer mission operation advantages and could be an attractive first EAP step from an ease of implementation perspective. Existing aircraft are already generating electricity from the turbofan engine shafts with embedded generators; replacing the generator with a motor/generator could be a straightforward option. Currently, the energy storage technologies required for a fully electric (i.e., battery-powered) aircraft are considered too immature with respect to energy capacity and energy density to be used for entry into service of a large transonic aircraft<sup>1</sup> prior to 2045; however, they are already viable for smaller, slower, and shorter range aircraft.

**A. Partial Turboelectric: NASA STARC-ABL**

NASA is currently exploring turboelectric propulsion options through a series of studies called Single-Aisle Turboelectric Aircraft (STARC). One of these concepts, STARC-ABL (Fig. 2), was developed assuming entry into service in 2035 and was compared against a similar technology conventional configuration by Welstead and Felder.<sup>2</sup> This partially turboelectric architecture consists of two underwing turbofans with generators extracting power from the turbofan shafts and transmitting it electrically to a rear fuselage, axisymmetric, boundary-layer ingesting fan. Results indicate that the turboelectric concept has an economic mission fuel burn reduction of 7 percent and a design mission fuel burn reduction of 12 percent compared to the conventional configuration. The original study used a cruise speed of Mach 0.7; however, a recent revision is being completed that increases the cruise speed to Mach 0.8 while still showing similar fuel burn benefits.

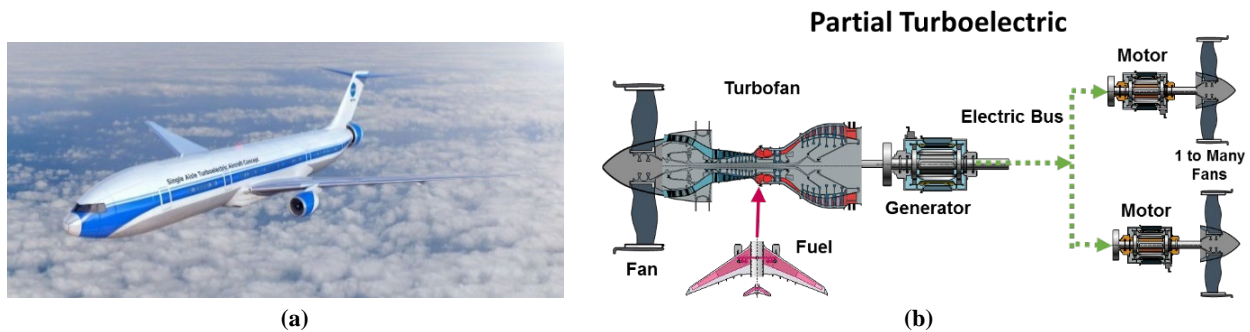

Figure 2. NASA Single-Aisle Turboelectric Aircraft With Aft Boundary Layer (STARC-ABL).

**B. Partially Turboelectric: Boeing SUGAR Freeze**

Boeing has conducted a large number of aircraft configuration studies with varying technology assumptions under their Subsonic Ultra Green Aircraft Research (SUGAR) efforts. One of the variants, shown in Fig. 3, is the hybrid electric SUGAR Freeze, which uses a wide array of advanced technology.<sup>3</sup> This configurations utilizes a truss-braced wing combined with a boundary-layer ingesting fan in an aft tail cone to maximize aerodynamic efficiency. The aft fan is powered by a solid oxide fuel cell topping cycle and driven by a superconducting motor with a cryogenic power management system. The combination of all of these technologies reduce energy use by 56 percent for a 900-mile economic mission.

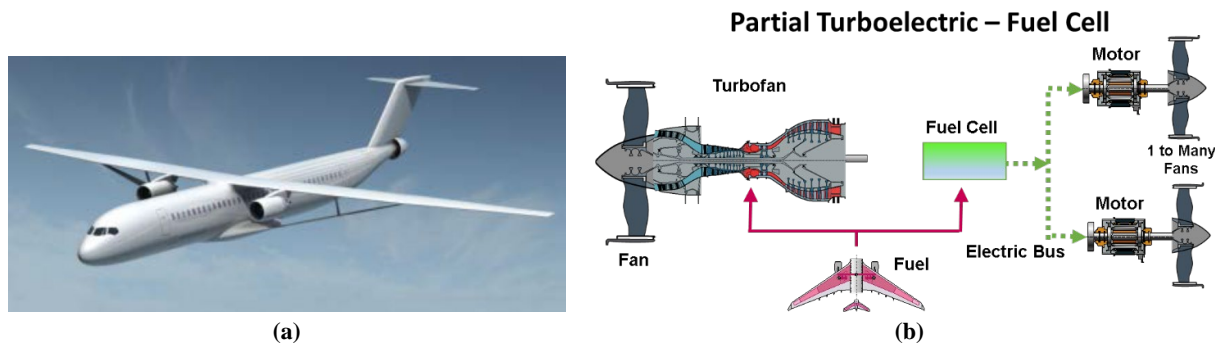

Figure 3. Boeing Subsonic Ultra Green Aircraft Research (SUGAR) Freeze.

**C. Fully Turboelectric: NASA N3-X**

Several years ago NASA developed the N3-X (Fig. 4), which explored fuel savings from combining a blended wing body design with a fully turboelectric and fully distributed propulsion system based on superconducting electric

machines and power distribution.<sup>4</sup> The fuel benefits of this configuration are very significant, estimated at a 70 percent reduction compared to a 777–200LR-like vehicle. The turboelectric distributed propulsion with boundary-layer ingesting fans accounts for 33 percent of the benefit, the hybrid wing body accounts for another 14 percent, and a number of other advanced technologies make up the remainder of the fuel burn benefit. This configuration has the greatest benefit of those studied; however, it requires the most aggressive technology development. Furthermore a number of simplifying assumptions were made in this early study that may need updating to commensurate with other vehicle concepts.

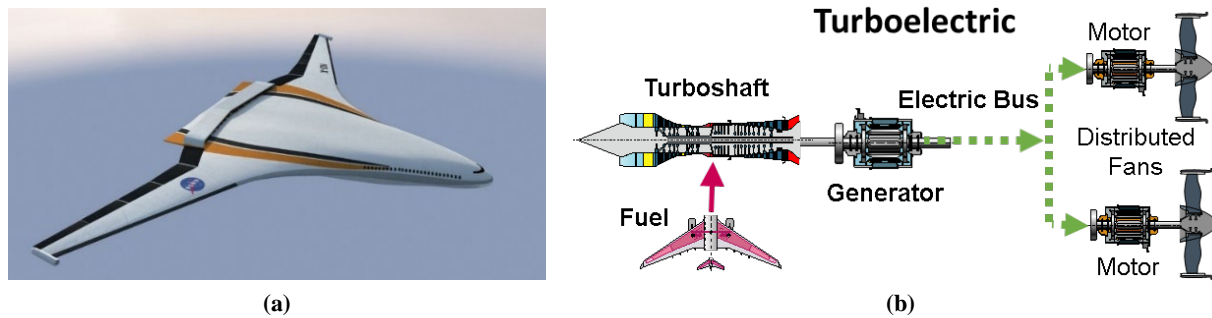

Figure 4. NASA N3-X.

#### D. Fully Turboelectric: Empirical Systems Aerospace ECO-150R

Empirical Systems Aerospace is developing regional jet and single-aisle EAP concepts that utilize a fully distributed propulsion system within a split wing concept.<sup>5</sup> The ECO-150 studies have considered a wide range of technologies for the electrical system, spanning superconducting electrical machines cooled with liquid hydrogen to conventional machines at various technology levels. Over the series of studies, the tools to estimate the aerodynamic, propulsive, structural, electrical, and thermal performance of the system were refined for greater accuracy. Depending on the underlying technology assumptions, the ECO-150 performance ranges between matching and significantly exceeding current aircraft fuel burn. The ECO-150R is a recent concept, which utilizes midterm electrical machine technology and has similar performance to current aircraft (Fig. 5).

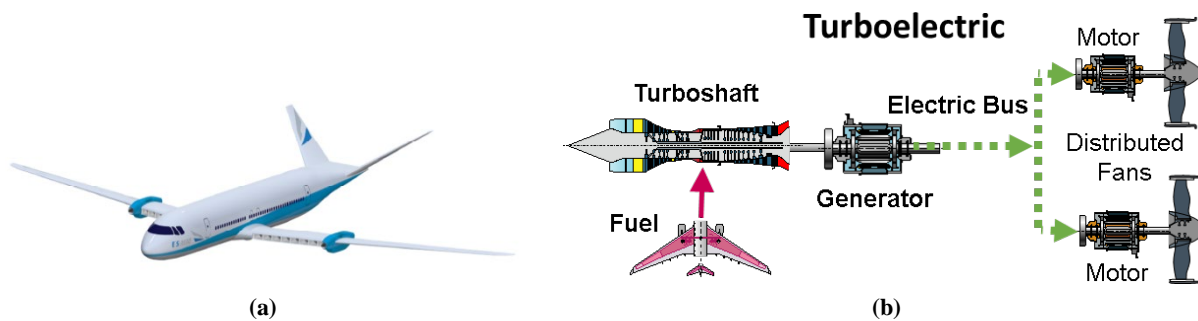

Figure 5. ESAero ECO-150R.

#### E. Parallel Hybrid Electric: Boeing SUGAR Volt

The Boeing SUGAR Volt design uses a parallel hybrid electric drive concept to augment the cruise portion of the mission by driving the fan with battery-powered motors.<sup>6</sup> The configuration is an advanced truss-braced wing aircraft with electrically augmented turbofans. The truss-based wing aircraft without the electrical system reduced fuel and energy consumption by 53 percent compared to the Boeing 737–800 baseline aircraft for a 900-nm economic mission. The SUGAR Volt (Fig. 6) concept was evaluated using conventional ambient temperature (total electrical system specific power 2 to 3 HP/lbm, 93 percent efficiency) and superconducting motors (total electrical system specific power 5 to 6 HP/lbm, 99 percent efficiency) at two power levels, 1.3 MW (1750 hp) and 5.3 MW (7150 hp). The 1.3-MW configuration achieves an additional 7 percent reduction in fuel savings over the advanced truss-braced wing aircraft to achieve the NASA goal of 60 percent fuel burn reduction. However, the two aircraft have the same total mission energy consumption because the Volt configuration is heavier. The 5.3 MW configuration provided enough power to allow the turbofan core engines to operate near idle during cruise. As a result, the mission fuel burn reduction was 10 percent; however, the larger and heavier electric motors and the much larger battery packs contributed to an 8

percent net gain in mission energy consumption relative to the truss-braced wing alone. Although this parallel hybrid configuration improved in-air fuel burn and emissions, the impact to overall energy efficiency was negligible.

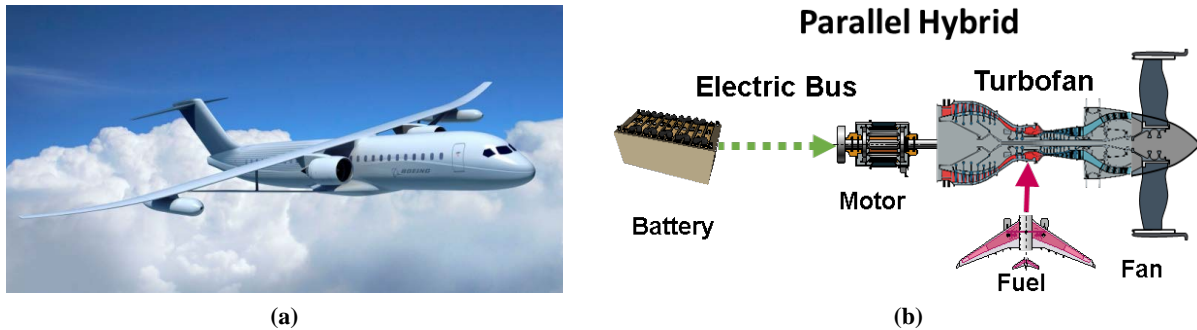

Figure 6. Boeing Subsonic Ultra Green Aircraft Research (SUGAR) Volt.

#### F. Parallel Hybrid Electric: Rolls-Royce North America Electrically Variable Engine (EVE)

Rolls-Royce North America has explored the optimization of the parallel hybrid electric propulsion trade space at the subcomponent level, the aircraft level, and the fleet management level with the EVE technology (Fig. 7).<sup>7</sup> These studies are finding concepts of operation with energy savings potential, and are exploring mission optimization using battery power to drive fans for taxiing, idle decent, and takeoff power augmentation. One key operational aspect was to always utilize and maximize takeoff weight and optimize the balance between battery and fuel weight for the desired mission range. This allowed more common short-range missions to maximize the mission energy coming from the batteries. Motor sizes between 1 MW and 2.6 MW were considered. The result was up to 28 percent reduction in fuel burn for a 900-nm mission, and up to a 10 percent total energy reduction for a 500-nm mission. Optimizing for minimum fuel usage predicts an 18 percent reduction in total fleet fuel usage. The analysis also explored optimization for minimum total mission energy (fuel energy + electrical energy), CO<sub>2</sub> production, or operational cost per flight. However, the system could not be optimized to minimize more than one objective at a time. For example, a system optimized to minimize fuel burn consumed 1.5 percent more energy, cost 4.3 percent more, and emitted 7.2 percent more CO<sub>2</sub> than a system, which was optimized to minimize each of these other objective functions.

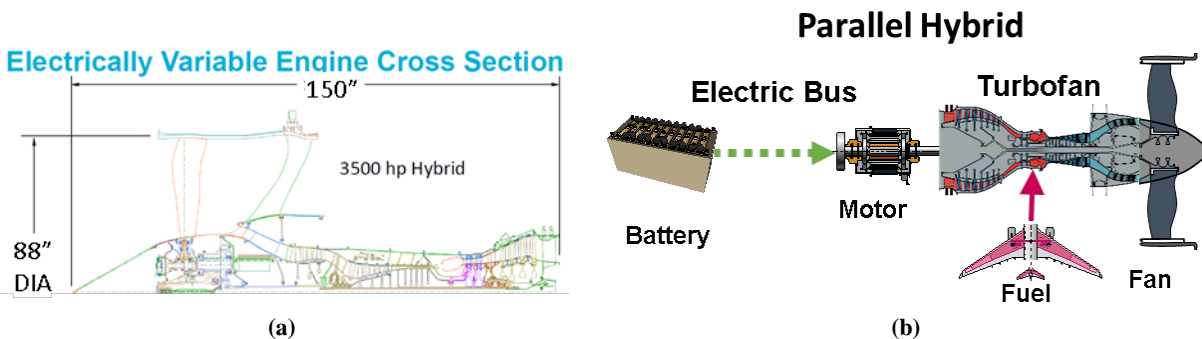

Figure 7. Rolls-Royce LibertyWorks Electrically Variable Engine (EVE) parallel hybrid.

#### G. Parallel Hybrid Electric: United Technology Research Center (UTRC) Geared Turbofan

UTRC has been exploring a parallel hybrid system, which utilizes a geared turbofan (GTF) providing 24,000 lbf of thrust and a 2.1-MW motor connected to the low spool tower shaft<sup>8</sup> (Fig. 8). The arrangement allows the low spool to be powered by the low-pressure turbine, or the motor, or any combination of the two. The motor is used to provide boost power during takeoff and climb, resulting in a smaller core, which is 2.3 percent more efficient than a conventional GTF at cruise. Mission analysis and sizing of the system were performed using the Boeing N+4 Refined SUGAR aircraft model as a baseline. This configuration required approximately 1300 kW-hr of energy storage, and energy densities between 200 and 1000 kW-hr/kg were used to establish system weight estimates with various technology advances. The studies have determined a system benefit of 7 to 9 percent in fuel burn reduction and a 3 to 5 percent energy reduction for the economic mission range of 900 miles utilizing the 1000 kW-hr/kg batteries.



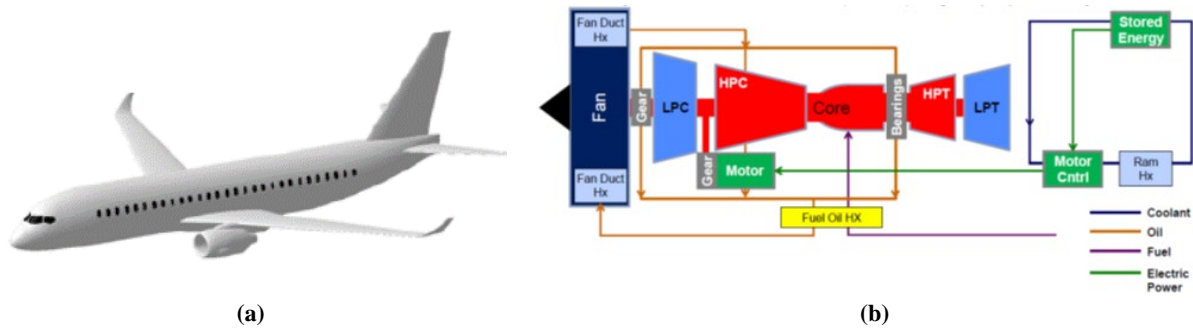

Figure 8. United Technology Research Center (UTRC) Hybrid Geared Turbofan System.

### III. Electric Machines

Research in the electrical power area is focused on building lightweight, high-efficiency motors and power converters in the megawatt class. Megawatt-level components were selected because they support the implementation of partially turboelectric and hybrid electric propulsion up to the single-aisle aircraft class, and fully turboelectric or hybrid electric systems for smaller aircraft. While specific power several times higher than industrial motors has been recognized as a key need for several years, the system benefits of combining high specific power with high efficiency have more recently become clear. NASA-sponsored efforts to develop megawatt-class motors are ongoing at the University of Illinois (1 MW) and at The Ohio State University (up to 10 MW). A 1.4-MW motor is being designed at NASA Glenn Research Center. The key performance and design parameters for each of these efforts are shown in Table 2.

Table 2. Megawatt-Scale Electric Machine Developments Sponsored by NASA

	Continuous power rating, MW	Specific power goal, kW/kg	Efficiency goal, %	Motor type	Speed	Nominal dimensions
University of Illinois	1	13	>96	Permanent magnet	18,000	Cylinder 0.45 m by 0.12 m
Ohio State University	2.7	13	>96	Induction	2,500	Ring 1.0 m by 0.12 m
NASA Glenn Research Center	1.4	16	>98	Wound field	6,800	Cylinder 0.40 m by 0.12 m

#### A. Permanent Magnet Electric Machine

University of Illinois is designing and building a permanent magnet synchronous motor to exceed a specific power of 13 kW/kg and efficiency of 96 percent.<sup>9</sup> The design, shown in Fig. 9(a), uses an outside rotor with a composite overwrap and permanent magnets. The motor integrated with the Rolls-Royce LibertyWorks EVE engine concept is shown in Fig. 9(b). The rotor prototype is shown in Fig. 9(c). Extensive analysis and subcomponent testing have been done to optimize the electromagnetic, structural, and thermal design. Analysis and optimization followed by full-speed validation testing of a prototype rotor was done to ensure the best possible permanent magnet/carbon fiber overwrap rotor design. The fundamental frequency of the motor is relatively high, and packing fraction needs to be optimized, requiring the use of form wound litz wire. Significant work has been done to optimize the winding and potting process and make thermal measurements of test coils to ensure that the estimated hot spot temperatures predicted analytically coincide with experimental results. The motor design is being coordinated with a design and build effort at the University of Illinois to produce a multilevel inverter, which potentially could be used to drive the motor.

#### B. Induction Electric Machine

The Ohio State University is developing a ring induction motor, which employs an innovative stator cooling method called Variable Cross-Section Wet Coil (VCSWC) to maximize current density.<sup>10</sup> The Ohio State University team is building three motor prototypes at 300 kW, 1 MW, and 2.6 MW to demonstrate key technologies, and has completed a conceptual design of a 10-MW motor.

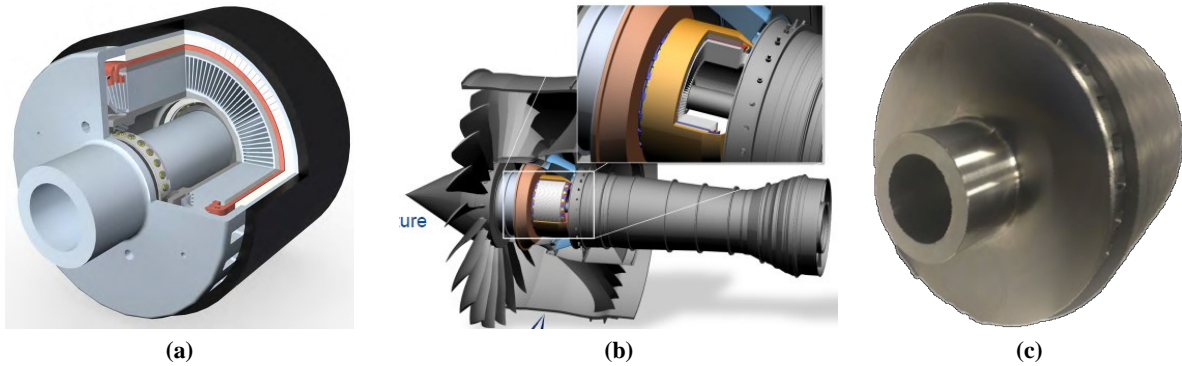

Figure 9. University of Illinois permanent magnet motor.

The VCSWC technology utilizes a tape conductor, which is the width of the slot in the active area, and widens at the end turns. The tape is wound through the slot and around the outside of the stator back iron, and the portion of conductor tape that is outside of the active region has direct liquid cooling (Fig. 10(a)). The combination of reduced resistance, due to the variable cross section, and direct liquid cooling allows high current density in the stator and consequently boosts the machine's specific power. The 10-MW motor concept is shown mounted in a turbfan in Fig. 10(b). The first prototype of the wet coil motor is shown in Fig. 10(c).

The three risk-reduction prototypes are used to retire risks for the wetted coil technology, the variable cross section technology, and the full motor integration technology, respectively. The first motor has been completed, the second is under construction, and the third motor is in the design phase. The third motor is planned to be 2.7 MW at 2700 rpm with a rotor diameter of 1 m.

The 10-MW ring motor design utilizes a fairly high number of poles to minimize the cross section of the stator and rotor. The motor speed rating is 5000 rpm and the air gap diameter is approximately 1 m. Operating at a high air gap surface speed has the advantage of boosting specific power, but it also has the penalty of complicating structural design and adding to the windage losses.

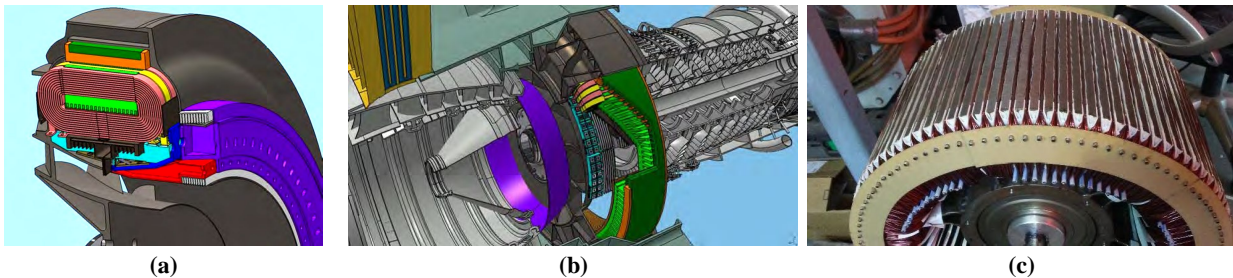

Figure 10. The Ohio State University 10-MW ring motor.

### C. Wound Field Synchronous Machine

NASA Glenn has a small in-house team that is developing a wound field synchronous motor with a performance goal of 16 kW/kg and efficiency greater than 98 percent (Fig. 11). The motor combines a self-cooled, superconducting rotor with a slotless stator, allowing the motor to achieve exceptional specific power and efficiency without inheriting the external cooling weight penalty commonly attributed to superconducting machines. A synchronous wound field machine was selected so that it can be shut down by deenergizing the field winding, which means that a machine being used in generator mode can be deactivated without decoupling the motor from the drive shaft. The design uses high-temperature dc superconductors for the field winding, which provides field strengths that cannot be achieved with permanent magnets or conventional conductors, and results in high specific power and efficiency. The rotor-mounted superconductors are cooled using a cryocooler that is integrated into the rotor, so there is no need for the aircraft to provide an external cooling system. Operational surface speeds of the rotor are kept relatively low, which allows for a direct motor drive option for a number of aircraft configurations.

System studies have shown that increasing motor efficiency from the current 96 percent (state-of-the-art) to 98 or 99 percent can reduce fuel burn for the STARC-ABL aircraft concept an additional 1 to 2 percent compared to its baseline benefit of 7 to 12 percent. Additionally, such increases in efficiency can reduce the amount of waste heat and related thermal management systems by a factor of 2 or 4, respectively, compared to the baseline.

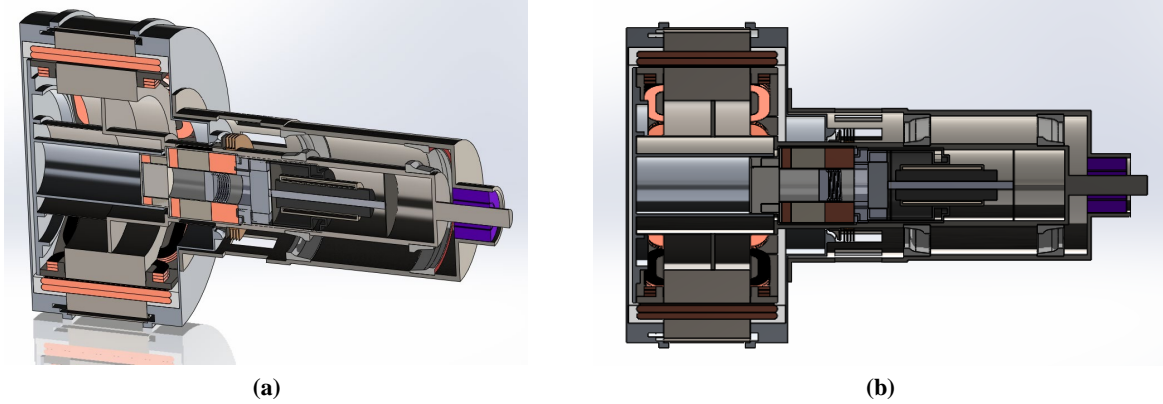

Figure 11. NASA Glenn Research Center wound synchronous motor.

#### IV. Converters

Power converters are an essential component in most EAP aircraft concepts, as they are used to convert from ac to dc power, or vice versa. Because of this commonality and because they are a major contributor to the powertrain’s weight, NASA is sponsoring three inverter (dc to ac converters) efforts at the 1-MW-size class. For these efforts, 1000 and 2400 V dc input voltages are assumed, each with a three-phase ac output, in order to address the power conversion typically required to feed an electric motor in advanced EAP concepts for large planes. Though current aviation power systems are restricted to a maximum voltage level of 540 V dc ( $\pm 270$  V), these efforts target higher bus voltages in recognition of the positive benefit of increasing voltage on overall size and weight of the powertrain. As an example, to deliver 1 MW over 150 ft, the 2000 V dc system can reduce the dc cable weight from 900 to 200 kg when compared to a 540 V system.

Two efforts are underway targeting specific powers of 19 kW/kg using traditional liquid cooling technology: General Electric (GE) is building a three-phase inverter using SiC power electronics, and the University of Illinois is building a 200-kW multilevel inverter using gallium nitride switches, which supports scaling to the 1 MW level. Additionally, in support of aircraft concepts with cryogenic fluids available (e.g., N3-X and SUGAR Freeze), Boeing is developing a cryogenically cooled inverter with a goal of 26 kW/kg and an efficiency greater than 99.3 percent and has conducted a fairly extensive set of cryogenic power switch characterization tests to understand the impact of cold temperatures on the switch performance. Table 3 summarizes these efforts.

Table 3. NASA-Sponsored Megawatt-Scale Converter Developments

	Continuous power rating, MW	Specific power goal, kW/kg	Efficiency goal, %	Topology	Switch material	Cooling
General Electric	1	19	99	3 level	SiC/Si	Liquid
University of Illinois	0.2	19	99	7 level	GaN	Liquid
Boeing	1	26	99.3		Si	Cryogenic

##### A. General Electric Silicon Carbide Inverter

The GE inverter implements SiC switch technology, using a 2400 V dc input and providing a three-phase output capability, generating an output fundamental frequency ranging between 1 to 3 kHz.<sup>11</sup> The design topology for this inverter is a three-level Active Neutral Point Clamped (ANPC) topology (Fig. 12(a)), combined with 1.7-kV power switches to minimize the number of components and maximize system reliability. GE’s 1.7-kV, 500 A, SiC metal oxide semiconductor field effect transistor (MOSFET) dual-switch power modules (Fig. 12(b)) are selected, which are sufficient to block 2.4 kV dc in a three-level topology. Silicon insulate gate bipolar transistors (IGBTs) are being considered as an alternative to SiC modules in certain locations in the topology, which would minimally impact efficiency.

The dc filter sizing is based on DO-160E, Section 21 (Fig 12(c)). There is no ac side electromagnetic interference (EMI) filter, but the ac cable will be shielded to prevent radiated EMI. In addition, the dv/dt filter and common mode filters are used on the ac side to meet the motor insulation requirements.



Two key challenges being addressed in this effort: reducing parasitic inductance in the system in order to achieve high switching speed and high efficiency and optimizing the system layout to minimize the dc side EMI filter weight. The current program culminates in a ground demo; however, additional research will be needed to enable 2.4 kV operation at high altitude.

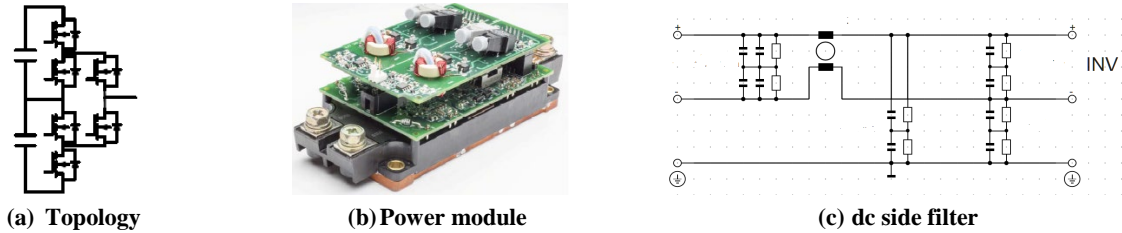
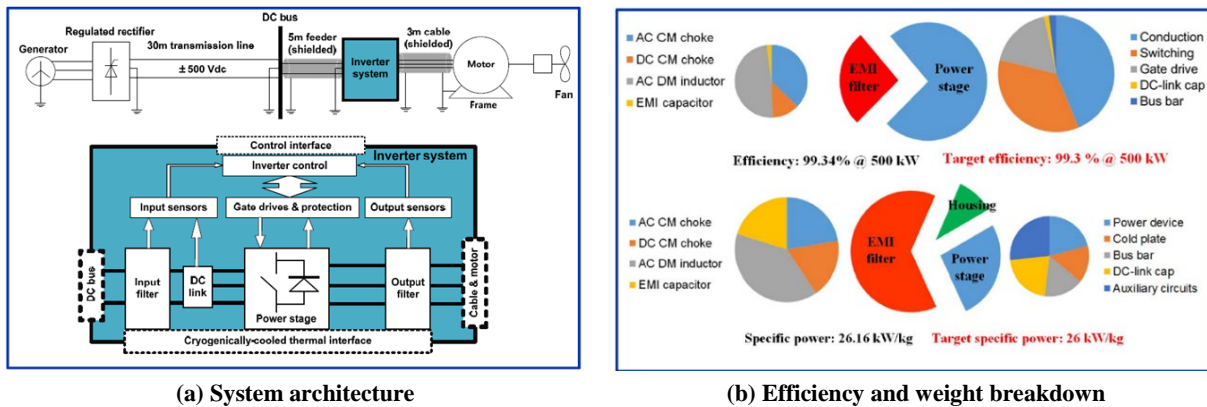

Figure 12. GE silicon carbide 1-MW inverter.

### B. Boeing

Boeing is developing a cryogenically cooled 1-MW inverter with the goal of achieving an efficiency of 99.3 percent at 500 kW power and a specific power of 26 kW/kg.<sup>12</sup> The design is intended to be compatible with liquid natural gas or hydrogen cooling, but the experimental prototype will be cooled by liquid nitrogen. The input dc voltage is 1000 V, and the output frequency is 200 to 3000 Hz. The inverter requires sufficient filters to meet DO-160 EMI standard, and both conventional and superconducting inductors were evaluated for this purpose. The candidate commercial-off-the-shelf power semiconductors were characterized from 77 K to room temperature for on-state resistance, breakdown voltage, and switching energy loss. The inverter design uses a three-level ANPC topology that uses different power switches for the fast and slow switching. A calorimeter was developed that can measure the efficiency of the 200-kW and 1-MW prototypes by the dissipated losses to the liquid nitrogen to better than 0.1 percent of the total power. Phase I of the project is complete with a design that meets the project goals.

Phase II of the design is ongoing with fabrication of a 200-kW inverter to reduce the risk of key design elements. Boeing is nearing completion of its design, simulation verification, and experimental validation of major functional components and architecture of the 200-kW inverter system, and progressing into hardware development stage. These functional components include some basic units of the 200-kW inverter system—a 40-kW converter, five of which will be paralleled for the 200-kW inverter; a gate driver unit responsible for switching control; a control module for modulation, voltage balance, circulation current control, and short-circuit protection; a small-scaled inverter for control and EMI reduction scheme prototyping; three-dimensional-printed EMI filter inductors; a cryogenic cooling system; design for reliability of both components and subsystems; and system integration and packaging. Phase III of the project will be construction and test of the 1-MW inverter (Fig. 13).



(a) System architecture

(b) Efficiency and weight breakdown

Figure 13. Boeing cryogenic silicon megawatt inverter.

### C. University of Illinois

The University of Illinois is building a 200-kW, multilevel, flying capacitor topology with gallium nitride power switches that is scalable to a 1-MW system (Fig. 14).<sup>13</sup> The topology employs nine levels and shifts the energy storage used in filtering elements from inductors, which are common to many designs, to capacitors, which have a much higher energy density. The dc bus voltage will be 1000 V. The benefits of the multilevel topology are low switch voltage stress, low capacitance, low device switching frequency, and low output ripple amplitude (because of the high effective output ripple frequency). Key challenges that are being addressed in this effort include balancing the capacitor voltages, minimizing parasitic inductance of the power modules, and developing effective approaches to gate drive and isolation.

Gallium-nitride-based field effect transistors (FETs) have shown great potential in the development of high power density converters and can be especially advantageous in cryogenic applications. Work performed for this effort showed an 85 percent reduction in on-state resistance and a 16 percent increase in threshold voltage at  $-195\text{ }^{\circ}\text{C}$ , without observing carrier freeze-out effects. Building on these results, a subscale (1-kW and three-level) prototype is being developed and tested to provide early confirmation of the inverter design. Results from prototype testing conducted at temperatures ranging from room temperature down to  $-140\text{ }^{\circ}\text{C}$  have shown a 16 percent reduction in losses at  $-60\text{ }^{\circ}\text{C}$  at the rated power level. An estimated power loss breakdown was performed, taking into account the decreasing conduction losses of the gallium nitride FETs and preliminary estimates of losses for the passive components. A development path combining high-performing gallium nitride FETs with passive components optimized for low-temperature operation is being pursued.

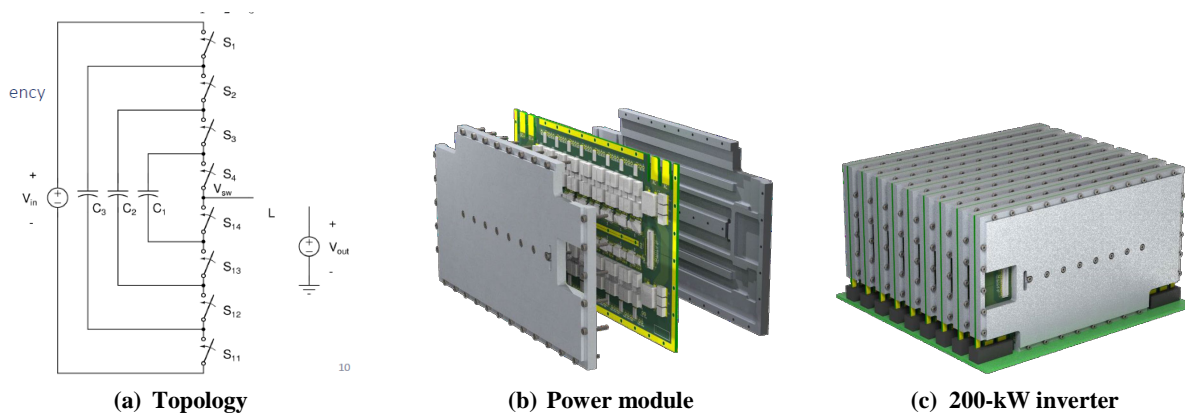

Figure 14. University of Illinois gallium nitride 200-kW inverter.

## V. Materials for Electrified Aircraft Propulsion

NASA research investments in magnetic materials, electrical insulators, and advanced electrical conductors are foundational for long-term performance advancements in motors, converters, and power transmission. In support of these efforts, NASA Glenn has established fabrication and characterization capabilities to transfer the next generation of soft magnetic materials from the laboratory into components. This fabrication and processing maturation will allow higher frequency and higher efficiency operation of inductors, transformers, and power conversion devices that in turn reduce magnetic losses and component size at the system level. Power cables can be a significant portion of the mass of an EAP system and are another area where materials research is vital. Three approaches are under consideration to reduce cable mass: high-voltage operation, normal conductors with specific conductivity higher than that of copper (Cu), and superconductors. The success of these approaches is being enabled by initial investments in insulation research as well as the exploration of high-conductivity material using Cu carbon nanotube (Cu-CNT) composites. Research efforts spanning several years have been conducted to develop a superconductor with the capability to carry ac at frequencies of several hundred hertz with promising results. This superconductor could be used for motors or distribution cable. NASA's material research represents a long-term investment to broadly improve power system performance and can have a wide impact through spinoff into other power applications.

### A. New Soft Magnetic Materials

Soft magnetic materials perform many key functions in devices that convert electrical power from one form to another (transformers), filter or dampen electrical circuits (inductors), and convert between electrical and mechanical power (motors and generators). Unfortunately, they are also a significant contributor to the total weight of such systems. Key soft magnetic material parameters are the magnetic saturation (the maximum contribution of the material

to flux density), and permeability (ease of magnetic switching response). An excellent summary of soft magnetic materials in general and the promising new class of amorphous-nanocrystalline composite alloys was given by Willard.<sup>14</sup> Unfortunately, application and maturity of this class has been hampered by production size limitations.

NASA is committed to alloy development and optimization, processing, and component development for this next generation class of passive components. NASA is developing a lab with both processing and material testing capability. A large-scale soft magnetic material spin casting unit originally developed under U.S. Army support has been transitioned to NASA (Fig. 15(a)) and has been upgraded to increase yield and ribbon quality. This is one of the few facilities in the United States capable of producing magnetic material ribbons wide enough for the development of low power loss and high operational frequency components and devices that enable electric machines and power electronics needed for Hybrid Electric and Turboelectric aircraft (Fig. 15(b)). Induction filter and transformer cores (Fig. 15(c)) have already been fabricated for NASA EAP components and for Department of Energy applications, and component-level testing is currently underway. In addition to lower losses at higher operation frequencies, the permeability customization of nanocrystalline alloys allows induction to be tailored without requiring a physical gap.

The lab hosts a wide range of magnetic material characterization equipment that includes an ac permeameter, a vibrating sample magnetometer, and a permanent magnet hysteresis graph. A custom-built core loss measurement system for soft magnetic materials complements the commercial unit, and allows for ac loss measurements using a spectrum of primary excitation waveforms over a large range of currents and voltages. The lab also possesses a Magneto-Optical Kerr Effect (MOKE) microscope. This tool allows for direct imaging of magnetic domains as well as measurement of magnetization curves on a variety of magnetic materials. The system has recently been upgraded with a stroboscopic capability that synchronizes the applied magnetic field excitation with the imaging light pulse, thus allowing for dynamic imaging of domain motion at frequencies up to 10 kHz. Such information is crucial to understanding magnetic domain motion, which is ultimately the key to controlling and minimizing component electrical losses.

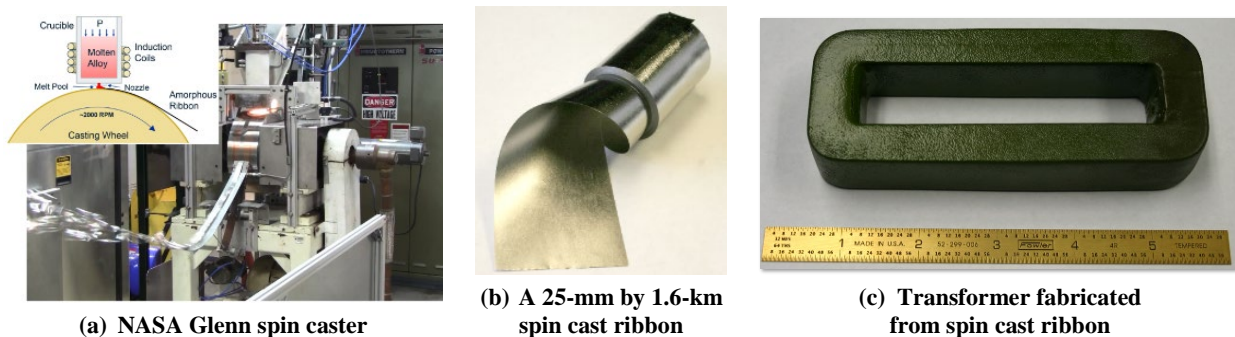
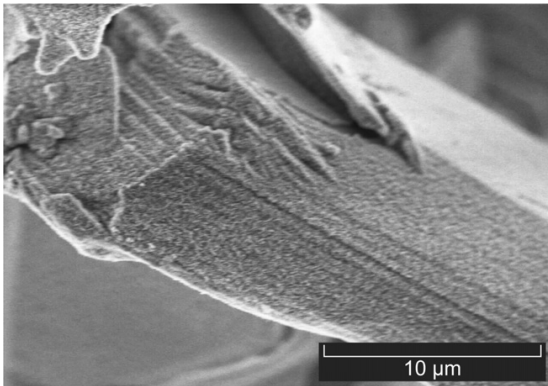

Figure 15. NASA Glenn Research Center magnetic materials.

## B. Insulation Development

Typical motor/generator designs employ electrical insulation in the form of wire coating, slot liners, endcaps, and potting material. Wire coatings within electromagnetic coils must be as thin as possible to maximize packing fraction. The wire coils are wound into slots in soft magnetic laminations and a slot liner provides electrical insulation between the coil and slot, as well as additional protection from physical abrasion of the thin wire coating. Potting material is incorporated to prevent movement that could result in fatigue or wear in the wire or wire coating. Endcaps can be applied to the top of the slot or additional insulation can be applied to the ends of the coils as they turn from one slot to another. Although the key role for materials in all of these insulation subcomponents is electrical isolation, thermal conductivity is equally impactful in electric machine design. Trapped heat increases the electrical resistance of conductors, resulting in lost efficiency, greater fuel consumption, and greater overall thermal management burden. Organic polymer insulations are preferred for low to medium temperature applications for their balanced properties of flexibility and electrical insulation. Increased molecular weight materials, such as those in the polyimide class, in general provide the best temperature and dielectric breakdown resistance of the organic classes. However, the increased molecular weight also increases the viscosity of the uncured resin, increases the required curing temperature, and precludes straightforward replacement in many bonding applications. Inorganic glass and ceramic insulators provide higher temperature capability, but at the expense of decreased ductility and flexibility. Developing composite insulations is a challenging process, since the resulting dielectric breakdown is a function of particles, loading, and interface developed through surface treatment.<sup>15</sup> Providing the insulation needs of new high-performance electric machines will require a balance of material development and intelligent and integrated design.

Two-dimensional ceramic particles in the microscales and nanoscales are the foundation of many state-of-the-art insulation solutions, and provide many promising approaches for further development. Recent work at NASA Glenn in separating hexagonal boron nitride (hBN) into nanosheets, thus exploring the use of established compounds in a new way.<sup>16</sup> Dielectric breakdown and thermal conductivity data for composites with a range of novel inorganic insulators such as boron nitride, flexible glass, and fine ceramic veils are also being reviewed. Figure 16(a) shows an alumina coated boron nitride particle and Fig. 16(b) shows thermal conductivity results for a consolidated composite. It is recommended that material development be combined with mesoscale modeling efforts that will allow designers to concomitantly survey traditional or nontraditional machine topologies with nontraditional insulation materials.



(a) FESEM image of coated hBN platelet

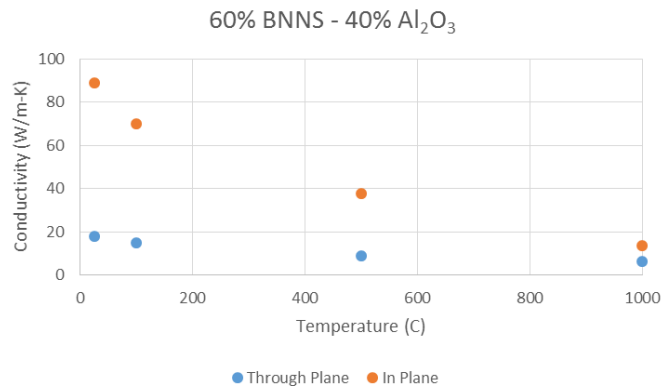

(b) Thermal conductivity

**Figure 16. Field emission scanning electron microscopy. (a) Thermal conductivity results. (b) Exfoliated boron nitride (BN) nanosheets consolidated in aluminum oxide.**

### C. High-Conductivity Copper/Carbon Nanotube Conductor

Subramaniam et al. greatly increased the community interest in carbon nanotube (CNT) composites when they reported specific conductivity and ampacity higher than pure Cu for very fine composite wires potentially suitable for electrical traces in miniature electronic devices.<sup>17</sup> Although current carrying capacity (ampacity) alone may be the relevant performance requirement of an electrical trace in an electronic device, the primary conductor requirements in EAP applications require improvement in absolute conduction relative to Cu at operational temperatures ( $6 \times 10^7$  S/m at 20 °C) for electric machine applications, and specific conduction better than aluminum ( $1.4 \times 10^7$  S-cc/m-g) for transmission applications. Graphene and CNT-based composites are being explored by a large number of research efforts in order to meet these challenging conductivity requirements. As illustrated in Fig. 17(a), measurements of some of the currently available CNT-based products does not meet the conductivity of Cu over a range of test temperatures from room temperature to 340 °C.<sup>18</sup> One option for addressing the fundamental conductivity of CNT products is through exploiting the improved conductivity of metallically bonded CNT. The properties of CNT depend greatly on the specific bonding or chirality.<sup>19</sup> Chirality, as determined by Raman spectroscopy, is being used to distinguish CNT populations. For example, one commercial CNT batch consisted of 34 percent “metallic” (m-CNT) and 66 percent “semiconductor” (s-CNT). The electrical conductivity of Buckypaper (sheets of CNT with no binder) made of normal (34 percent m-CNT, 66 percent s-CNT) and sorted (95 percent m-CNT, 5 percent s-CNT) were measured. The average conductivity of the CNT in the sorted, predominately metallic Buckypaper was 2.5 times higher than the CNT in the unsorted Buckypaper, as shown in Fig. 17(b).<sup>20</sup> Yet even the best Buckypaper conductivity is still well below that of pure Cu. NASA is addressing the connectivity of developing electrically conductive interfaces in a Cu matrix through both in-house research and outside investment, with a long-term goal of enabling both cost-effective sorting techniques and electrically conductive composite wires.



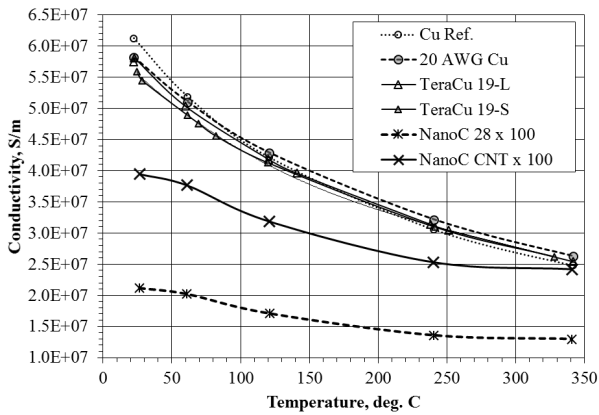

(a) Conductivity for Cu, CNT/Cu, and CNT yarns, ordered top to bottom

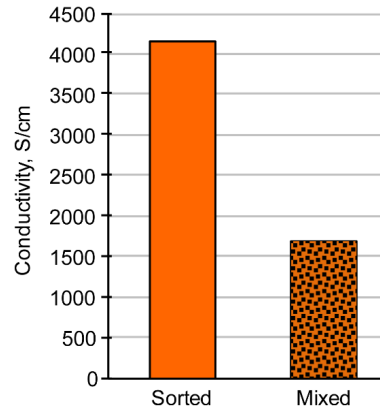

(b) Conductivity of sorted metallic and mixed CNT Buckypaper

Figure 17. Conductivity measurements performed on copper (Cu), carbon nanotubes (CNTs), and composites.

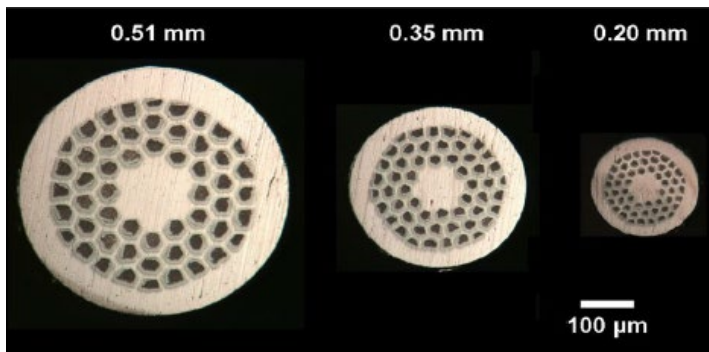

(a) Hyper Tech produced multifilament MgB<sub>2</sub> superconducting wires



(b) CAPS idealized magnetic field test capability for wire segments

Figure 18. Demonstrated improvements in superconducting wire fabrication and testing.

#### D. Superconducting Wire Development

Another more mature form of advanced conductors are superconductors. Superconductors conduct electricity with zero resistance, when operated below a critical state that is a function of temperature, current density, and magnetic field. Superconducting wires conducting dc incur very low losses in transmission, are widely used in magnetic resonance imaging, and are making application advancements in current limiters and lower speed electric machines. However, extension of superconducting technology to the high-speed electric machines envisioned for large transport aircraft is challenging for two main reasons. Firstly, most superconductors are brittle compounds that must be supported by ductile sheathing; this sheath must be compatible with the superconducting material with respect to chemistry, thermal expansion, and electromagnetic environment. Secondly, applied magnetic fields induce hysteresis and eddy current losses in superconducting-based coil systems (ac losses) that require increased cooling capacity at a system level. Superconductors based on the intermetallic compound magnesium diboride, MgB<sub>2</sub>, provide a balance of medium-high critical temperature, medium-high critical field, and low anisotropy that is attractive for many magnetic field applications, including possible high-speed electric machine development.<sup>21-23</sup>

The ability to fabricate MgB<sub>2</sub> as a multifilament wire offers the possibility of designing electric machines with relatively low transport and eddy current losses, as well as zero resistive losses. Through a series of NASA Small Business Research Initiative contracts, fabrication techniques for MgB<sub>2</sub>-based conductors were improved, and small filament sizes as low as 10 µm were demonstrated (Fig. 18(a)). In addition to demonstrating fine filament sizes, a range of wire fabrication options for filament size and twist pitch are being fabricated and tested to provide multiple options for future coil designs. NASA has also sponsored the development of an experimental capability to calorimetrically measure ac losses and stability properties of superconductors at temperatures as low as 15 K under simultaneous ac transport current and rotating and pulsating magnetic fields as would occur in rotating machine stators.



This work is being conducted at the Center for Advanced Power Systems at Florida State University in conjunction with the Advanced Magnet Laboratory (Fig. 18(b)).<sup>24</sup> Through these research efforts, the mechanism enabling low ac losses in superconductors has been determined to be a combination of small effective filament diameter, small twist pitch, electrically resistive matrix material, nonmagnetic sheathing material, and a balance of operating temperature and external applied field.

## VI. Test Capabilities

Development efforts are underway to provide essential test capabilities that will be required to validate EAP aircraft designs ahead of flight testing. The NASA Electric Aircraft Testbed (NEAT) is being built at NASA Glenn’s Plum Brook Station to address full-scale testing of multimewatt powertrains, with an eye toward incorporating the component technologies into an overall system. Hybrid Electric Integrated System Testbed (HEIST) at the NASA Armstrong Flight Research Center (AFRC) will explore initial concept of operation scenarios and flight controls approaches at lower power levels.

### A. NASA Electric Aircraft Testbed (NEAT)

NEAT is being developed to enable end-to-end development and testing of a full-scale electric aircraft powertrain.<sup>25</sup> As large airline companies compete to reduce emissions, fuel burn, noise, and maintenance costs, NASA expects that more aircraft systems will shift from the use of turbofan propulsion, pneumatic bleed power, and hydraulic actuation to using electrical motor propulsion, generator power, and electrical actuation. This change requires development of new flight-weight and flight-efficient powertrain components, fault-tolerant power management, and electromagnetic interference mitigation technologies. Moreover, initial studies indicate that some combination of ambient and cryogenic thermal management coupled with higher-than-standard bus voltages will be required to achieve a net system benefit. Developing all of these powertrain technologies, within a realistic aircraft architectural geometry, and under realistic operational conditions, requires a unique electric aircraft testbed.

NEAT is being designed with a reconfigurable architecture that industry, academia, and Government can utilize to further mature electric aircraft technologies. This testbed is intended to be complementary with other capabilities that are already in existence. The primary purpose of the testbed is to enable the high-power ambient and cryogenic flight-weight power system testing required for the development to technology readiness level (TRL) 6 of the technology areas listed in Table 4. This test facility is intended to exercise system-level design approaches, and to provide a viable path for full-scale powertrain component development and demonstration prior to flight for innovative EAP aircraft designs.

**Table 4. NASA Electric Aircraft Testbed (NEAT)-Supported Technologies**

Technology area	Details
High-voltage bus architecture	Insulation and geometry; 600 to 4500 V
High-power converters	Megawatt-level testing of commercial, in-house, and NASA components
System communication	Aircraft Controller Area Network (CAN), Ethernet, and fiber optics
Electric Machines	Megawatt-level testing of commercial, in-house, and NASA components
System communication	Aircraft Controller Area Network (CAN), Ethernet, and fiber optics
System electromagnetic interference (EMI) mitigation and standards	DOD–160 (RTCA, Inc., 2010) and MIL–STD–461 (Department of Defense, 2015)
System fault protection	Fuses, circuit breakers, and current limiters

As illustrated in Fig. 19, NEAT is a full-scale testbed that is being developed in order to support single-aisle aircraft scale geometry (for proper cable length and EMI), power (up to 24 MW when regenerated), thermal (up to 2 MW heat rejection), and altitude (up to 120,000 feet pressure). Moreover, there is potential for expansion in future years; addition of jet fuel for turbogeneration is possible, and there is a remote control room, which can support hazardous testing with flammable cryogenic fluids and/or in situ ducted fan loading. For testing of the electrical powertrain only, the turbines and ducted fans are emulated with properly scaled electric motors and generators; these electric machines are configured to match the speed, torque, and inertia characteristics of aircraft turbines and fans, in order to test under all segments of a complete airplane mission (takeoff, climb, cruise, etc.).

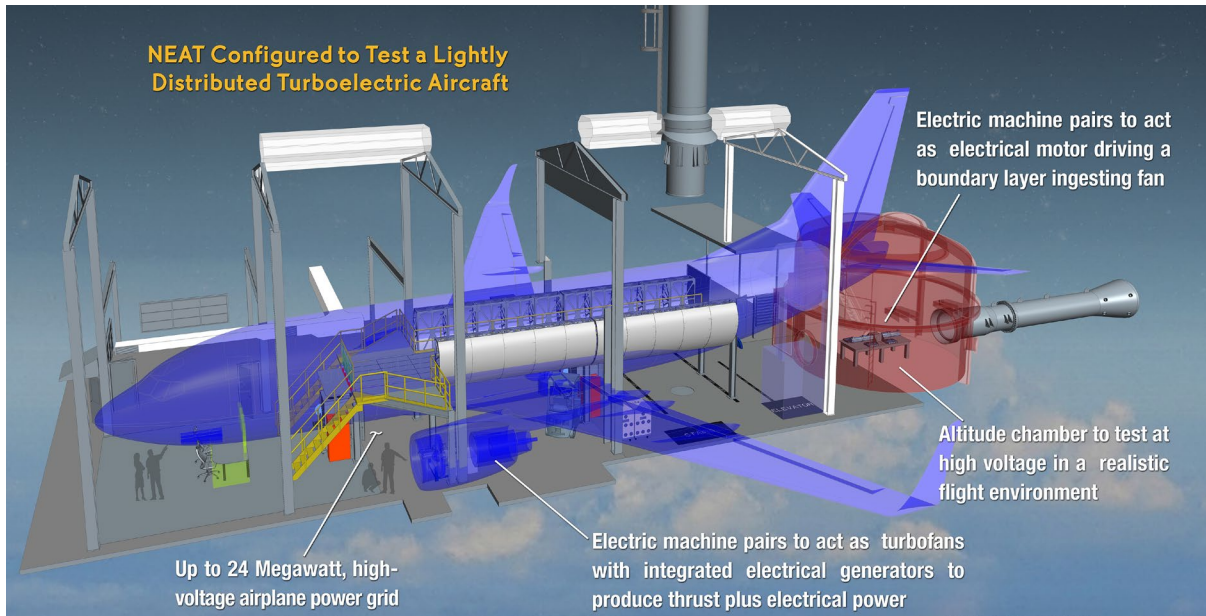

Figure 19. NASA Electric Aircraft Testbed (NEAT).

### B. Hybrid Electric Integrated Systems Testbed (HEIST)

The HEIST is being developed to study power management and transition complexities, modular architectures, and flight control laws for turboelectric distributed propulsion technologies using representative hardware and piloted simulations.<sup>26</sup> Even for mildly distributed aircraft, there are additional degrees of freedom available with respect to controlling the plane, managing power and safety, and optimizing the mission flight profile that can be exploited to provide energy savings. Systems such as the ECO-150-R with its 16 wing fans, a significantly rich bed of opportunity for flight controls research exists. The HEIST is configured in the fashion of an iron bird to provide realistic interactions, latencies, dynamic responses, fault conditions, and other interdependencies for turboelectric distributed aircraft, but scaled to the 200 kW level. In contrast with NEAT, HEIST has power and voltage levels that would be considered subscale for a commercial transport, but test capability extends to the entire airplane system and can exercise all aspects of flight control, including cockpit operations.

Figure 20 illustrates the research objectives that are intended to be examined with the HEIST, organized in terms of four embedded control loops. The innermost loop, Embedded Controller/Distributed Intelligence, comprises systems that are used to manage the fan motors, the turbogenerator, and the battery system in an efficient and lightweight manner with sufficient electromagnetic interference compatibility, adequate bus stability, fault management, and thermal management. The Powertrain Command and Control Loop optimizes aerodynamic and electrical efficiencies by managing and distributing electrical loads among the propulsors during simulated aircraft missions. Unique to distributed electrical aircraft is the inherent ability to use the propulsors to carry out flight control; the Flight Maneuver Command and Control Loop command the electrically driven fans along the wing to perform yaw control, improve stability, and provide more rapid recovery from fault conditions. Research will be conducted to explore stability and performance limits using simulated flight profiles. If sufficient cases can be found for stability improvements, the potential exists to reduce the size of the airplane's vertical tail and provide significant mass reductions. Overlaying the entire control system is the Mission Command and Control Loop, which is used to optimize fuel and electrical energy usage for a given mission by controlling the battery and turbogenerator systems. Mission profiling will be performed via this outer loop to investigate how energy storage would be used to enhance a turboelectric design. Turbogenerators can be sized for cruise conditions, with batteries providing boost power during the taxi/takeoff, full-power climb, climb, powered landing, and landing/taxi segments. Batteries can also accept and store energy when the turbogenerators are providing excess power and during descent when the wing-mounted motors are driven in reverse by the airflow (windmilling) and produce energy.

The HEIST test equipment will include three trailers supporting a distributed electric propulsion wing, which includes propellers, a battery system, a turbogenerator, dynamometers, and supporting power and communication infrastructure, all connected to a core flight simulation system (Fig. 21). The wing is designed to house 18 high-performance electric motors that will initially be powered by a battery simulator, and eventually will be fed by a

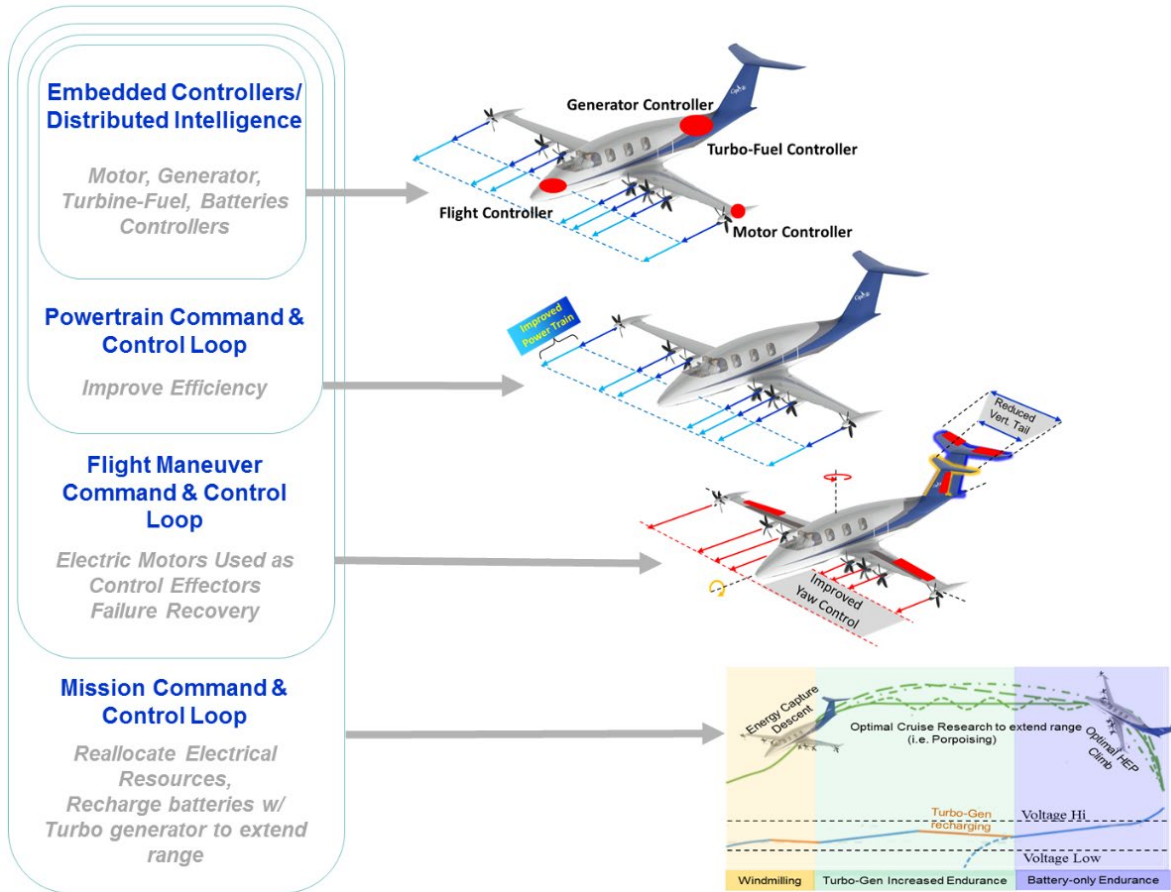

Figure 20. Hybrid Electric Integrated System Testbed (HEIST) flight control research objectives.

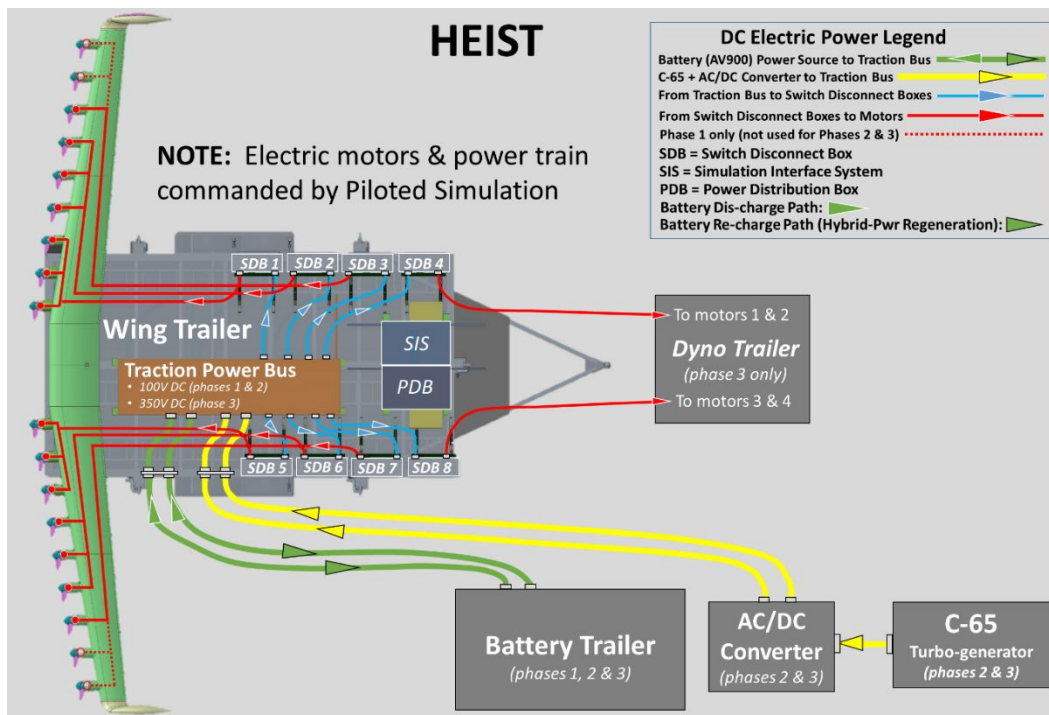

Figure 21. Hybrid-Electric Integrated Systems Testbed (HEIST)—concept of operations view.

200-kW, 350 V battery system, a 65-kW turbogenerator, or a hybrid combination of both sources. Flight control algorithms will be developed and tested through a piloted flight simulator that interacts with the testbed and will be scalable to megawatt-class aircraft applications. The propellers provide static thrust loads, and four dynamometers will provide additional ability to study aerodynamics effects and windmilling. These loads will be commanded by the flight simulation in accordance with the mission profiles that are being researched.

## VII. Emerging Challenges

### A. Turbine/Generator Integration and Controls

Distributed propulsion systems for large aircraft are commonly conceived to use gas turbine engines to drive electric generators in order to provide enough total electrical power to feed the requirements of the distributed, electrically powered propulsors. The type of gas turbine used will depend on the degree to which the propulsion system relies on electrically driven propulsors. For fully turboelectric systems such as the N3-X,<sup>4</sup> turboshaft engines are used to convert all shaft power to electrical power to drive multiple propulsors. In partially turboelectric systems such as STARC-ABL, the turbofan serves the dual purpose of producing local propulsive thrust plus shaft power to drive generators for the distributed electrical propulsors. In the partially turboelectric concept the low pressure turbine must drive the fan, low-pressure compressor, and electrical generator. This deviates from a conventional turbofan where the low-pressure turbine drives the fan and the low-pressure compressor only. STARC-ABL's two turbofan engines, as an example, would need to produce 80 percent of the aircraft's thrust during takeoff and 55 percent at the top of climb.<sup>2</sup> Since they do not provide 100 percent of the total thrust, the fan and nacelle diameter can be smaller. However, since the turbofan's low-pressure turbine is ultimately powering the fans and the motor-driven aft fan and must also overcome losses in transmission and energy conversion, the core size is not reduced and the low-pressure turbine is about the same size.

Even for the lightly distributed STARC-ABL, the percentage of low-pressure turbine power converted to electricity in the generator at cruise can exceed 25 percent, and for concepts, which rely more heavily on electrically driven thrusters, the percentage can be higher. Since the goal of propulsive power redistribution is to save overall energy use and fuel burn, it will be important to verify that the engine itself does not take a significant hit in efficiency or in performance and maintains lifecycle operability expectations. Additionally, the amount of power extracted from the turbine engine will be variable during an aircraft's flight mission. This increased variability and the added complexity of employing distributed fans that have been made independent of the turbine engine present challenges for engine operability and control. The turbine engine and its control system will have to be designed for the variable conditions imposed by mission requirements, while integrating seamlessly with the power electronics.

It is anticipated that varying mechanical and electrical loads will incite incidence problems within the turbomachinery blade rows, and it is therefore likely that the engine will be operating in a region outside of a typical design range for at least portions of the flight envelope. Future studies are being considered to explicitly define these challenges, considering whether approaches such as incident-tolerant airfoils, variable geometries, or active flow control within the turbine components of the engine are needed.

As always, thermal management, geometric and mechanical design integration, bearings, rotor dynamics, control, and fault tolerance will need to be assessed at every stage of conceptualization in order to ensure that an integrated solution is achievable, cost effective, and fits within the volume and weight estimations. NASA is beginning to invest in studies to capture the key potential issues, define gaps in understanding or modeling capability, and formulate a plan to retire the major risks associated with integrating high-power generators into the turbofan engines for commercial transport electrified aircraft.

### B. Validation of Boundary-Layer Ingestion Benefits

Harvesting the potential aerodynamic efficiency benefits that can be achieved through proper integration of distributing propulsion components is key to the success of EAP architectures. For many transport class designs, electrically driven fans are placed in the boundary layer to reenergize the low velocity stream and decrease drag. NASA's hybrid wing body N3-X and Airbus's E-Thrust both use a wide nacelle with semi-embedded fans to ingest a large portion of the boundary layer, taking advantage of the low-velocity inlet conditions to increase fan efficiency and reduce induced drag caused by friction.<sup>27</sup> STARC-ABL takes advantage of the boundary conditions at the rear fuselage of a conventional tube and wing airplane, with an axisymmetric tail cone thruster driven by an electric motor. This concept's aft fan is sized to capture 45 percent of the boundary layer height with a predicted recovery of 70 percent of the induced momentum deficit. The overall result for this aircraft is that thrust is produced more efficiently by the tail cone thruster than by the underwing-mounted engines, which is essential to the predicted overall energy and fuel burn savings.

While initial concepts show promise, detailed analyses are required to validate the assumptions, recommend shaping of the structure, and support design trades associated with propulsion airframe integration. Figure 22 shows the solution

of a high-computational fluid dynamics (CFD) simulation for the STARC–ABL concept, which is being developed to inform the design of the rear fuselage and integrate the tail cone thruster structurally. Results from these preliminary studies will feed into future work that will look at trades between ducted fan and open rotor concepts for the tail cone thruster. A structured overset grid generation procedure has been developed, which is capable of accurately capturing the growing boundary layer along the fuselage and its interaction with downstream propulsion components. Simulations on the structured overset grids were performed using the Launch Ascent Vehicle Aerodynamics (LAVA) framework, developed at NASA to solve aerodynamic and aeroacoustic problems on complex geometries.<sup>28</sup>

Ultimately, wind tunnel tests will be required in order to assess the predicted performance benefits of the boundary-layer ingesting tail cone thruster and to validate the CFD models. Efforts have begun to develop the outer mold line model and to develop test requirements that would be used to inform anticipated future tests, using high-fidelity CFD tools to aid in the definition. The LAVA tool was enhanced by adding a series of propulsion models into its solver with varying degrees of complexity to allow the modeled propulsion system to mature in fidelity as the airplane concept fidelity matures. Figure 23 shows a plot of the pressure coefficient through an early tail cone thruster design. The large rise in pressure through the actuator zone surface mimics the thrust produced by the fan onto the fluid.

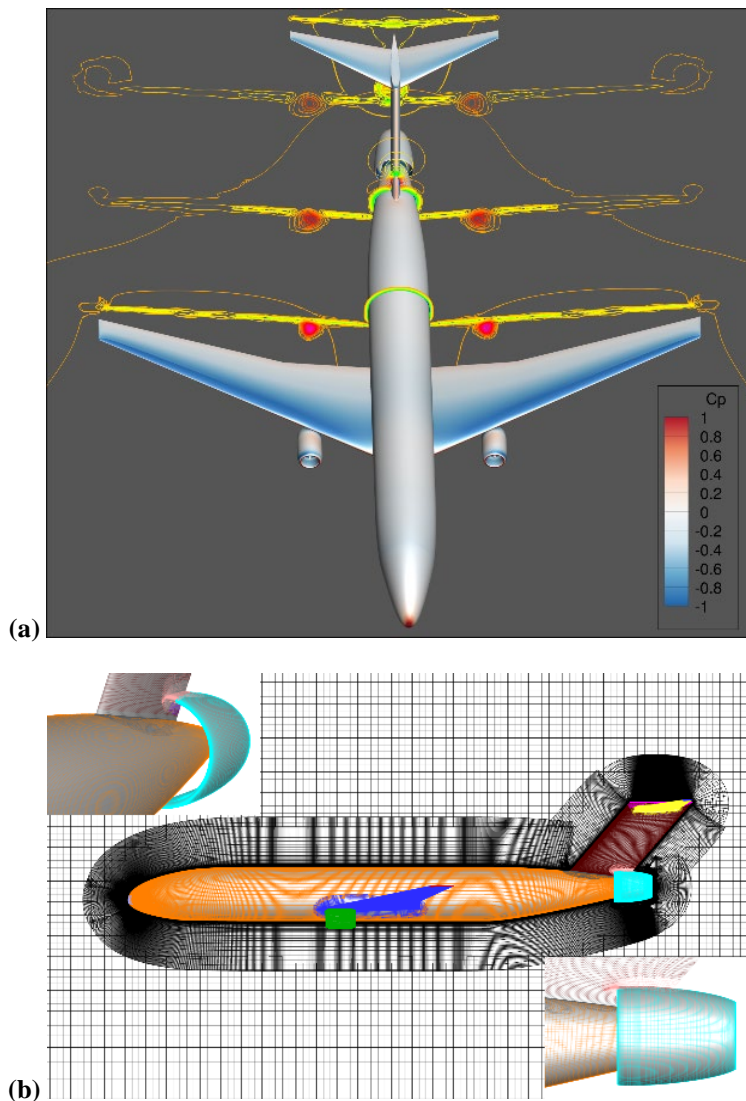

**Figure 22. High-fidelity computational fluid dynamics (CFD) for Single-Aisle Turboelectric Aircraft With Aft Boundary Layer (STARC–ABL) concept. (a) Surface pressure and streamwise slices of velocity magnitude. (b) Structured overset grid for accurate capturing of boundary layer ingested into tail cone thruster.**



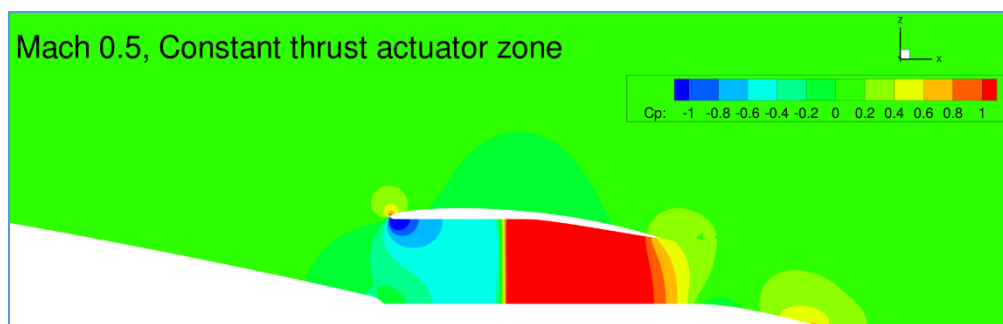

Figure 23. Tail cone thruster pressure coefficient.

## VIII. Conclusion

NASA is making significant progress towards establishing the viability of Electrified Aircraft Propulsion (EAP) through a combination of aircraft conceptual design studies and advancement of key tail-pole technologies. In the aircraft system area, partially turboelectric and parallel hybrid candidates have been shown viable for introduction into service in 2035, and a long-term vision has been established for a fully turboelectric system with extremely significant fuel burn benefits. NASA is developing key powertrain technologies that are applicable for a wide variety of large aircraft configurations, including electrical machines (motors/generators), converters (inverters/rectifiers), and the underlying electrical materials for EMI filters and cabling. Advances over the last 5 years are proving to significantly improve the viability of large EAP systems, and in the next 5 years the goal is to narrow the focus to the most viable concepts as a means to prepare for flight demonstrations of those concepts. It is believed that the right building blocks are in place to have a viable large-plane EAP configuration tested by 2025 leading to entry into service in 2035 if resources can be harnessed toward pursuing that goal.

## Acknowledgments

This work is sponsored by the NASA Aeronautics Research Mission Directorate, Advanced Air Vehicles Program, Advanced Air Transport Technology Project. The authors would like to recognize the researchers conducting the described work, which are part of small business, large aerospace corporations, universities, and NASA. The authors would also like to acknowledge contributors that provided material for this paper or participated in the review of the paper.

## References

- <sup>1</sup>National Academies of Sciences, Engineering, and Medicine, *Commercial Aircraft Propulsion and Energy Systems Research: Reducing Global Carbon Emissions*, The National Academies Press, Washington, DC, 2016, Chap. 4.
- <sup>2</sup>Welstead, J., and Felder, J. L., "Conceptual Design of a Single-Aisle Turboelectric Commercial Transport with Fuselage Boundary Layer Ingestion," *54th AIAA Aerospace Sciences Meeting*, AIAA, Reston, VA, 2016.
- <sup>3</sup>Bradley, M. K., and Droney, C. K., "Subsonic Ultra Green Aircraft Research Phase II: N+4 Advanced Concept Development," NASA/CR—2012-217556, 2012.
- <sup>4</sup>Felder, J. L., Brown, G. V., and Kim, H. D., "Turboelectric Distributed Propulsion in a Hybrid Wing Body Aircraft," *20th International Society for Airbreathing Engines*, ISABE-2011-1340, Gothenburg; Sweden, 2011.
- <sup>5</sup>Schiltgen, B. T., Freeman, J. L., and Hall, D. W., "Aeropropulsive Interaction and Thermal System Integration within the ECO-150: A Turboelectric Distributed Propulsion Airliner with Conventional Electric Machines," *AIAA Aviation Technology, Integration and Operations Conference*, AIAA 2016-4064, AIAA, Reston, VA, 2016.
- <sup>6</sup>Bradley, M. K., and Droney, C. K., "Subsonic Ultra Green Aircraft Research: Phase II—Volume II—Hybrid Electric Exploration," NASA/CR—2015-218704, 2015.
- <sup>7</sup>Perullo, C., Trawick, D., Armstrong, M., Tai, J. C. M., and Mavris, D. M., "Cycle Selection and Sizing of a Single-Aisle Transport with the Electrically Variable Engine (EVE) for Fleet Level Fuel Optimization," *55th AIAA Aerospace Sciences Meeting*, AIAA 2017-1923, AIAA, Reston, VA, 2017.
- <sup>8</sup>Lents, C., Hardin, L., and Rheume, J., "Parallel Hybrid Gas-Electric Geared Turbofan Engine Conceptual Design and Benefits Analysis," *52nd AIAA/SAE/ASEE Joint Propulsion Conference*, AIAA 2016-4610, AIAA, Reston, VA, 2016.
- <sup>9</sup>Haran, K. S., "High Speed, High Frequency Air-core Machine and Drive," *55th AIAA Aerospace Sciences Meeting*, AIAA, Reston, VA, 2017.
- <sup>10</sup>Cantemir, C. G., and Munteanu, A., "10 MW Ring Motor," *55th AIAA Aerospace Sciences Meeting*, AIAA, Reston, VA, 2017.
- <sup>11</sup>Zhang, D., "NASA SiC Light-Weight Inverter for MW-Power (SLIM)—Phase I," *55th AIAA Aerospace Sciences Meeting*, AIAA, Reston, VA, 2017.

- <sup>12</sup>Liu, S., "Ultra-Light Highly Efficient MW-Class Cryogenically-Cooled Inverter," *55th AIAA Aerospace Sciences Meeting*, AIAA, Reston, VA, 2017.
- <sup>13</sup>Pilawa, R., "Modular and Scalable High Efficiency Power Inverters for Extreme Power Density Applications," *55th AIAA Aerospace Sciences Meeting*, AIAA, Reston, VA, 2017.
- <sup>14</sup>Willard, M. A., and Daniil, M., "Nanocrystalline Soft Magnetic Alloys Two Decades of Progress," *Handbook of Magnetic Materials Vol. 21*, edited by K. H. J. Buschow, Elsevier, Amsterdam, The Netherlands, 2013, pp. 173-342.
- <sup>15</sup>Lau, et al., "On the Space Charge and DC Breakdown Behavior of Polyethylene/Silica Nanocomposite," *IEEE Trans. Dielect. Ins.*, Vol. 21, No. 1, 2014.
- <sup>16</sup>Hung C-C, et al., "Highly Thermally Conductive Hexagonal Boron Nitride/Alumina Composite Made From Commercial Hexagonal Boron Nitride," *J. Am. Ceram. Soc.*, Vol. 100, 2017, pp. 515–519.
- <sup>17</sup>Subramaniam, C., et al., "One Hundred Fold Increase in Current Carrying Capacity in a Carbon Nanotube–Copper Composite," *Nature Communications*, [online journal], Vol. 4, Article number: 2202(2013), 23 Jul 2013, URL: <https://www.nature.com/articles/ncomms3202> [cited 21 Nov. 2013].
- <sup>18</sup>de Groh III, H. C., "Consideration of Conductive Motor Winding Materials at Room and Elevated Temperatures," NASA/TM—2015-218882, 2015.
- <sup>19</sup>Bandaru, P. R., "Electrical Properties and Applications of Carbon Nanotube Structures," *J. of Nanosci. and Nanotechnol.*, Vol. 7, No. 3, 2007, pp. 1-29.
- <sup>20</sup>de Groh III, H. C., "Highly Conductive Wire: Cu Carbon Nanotube Composite Ampacity and Metallic CNT Buckypaper Conductivity," NASA/TM—2017-219480, 2017.
- <sup>21</sup>Vinod, K., Abhilash Kumar, R. G., and Syamaprasad, U., "Prospects for MgB<sub>2</sub> Superconductors for Magnet Application," *Supercond. Sci. Technol.*, Vol. 20, No. 1, 2007, pp. R1-R13.
- <sup>22</sup>Tomsic, M., et al., "Overview of MgB<sub>2</sub> Superconductor Applications," *Int. J. Appl. Ceram. Technol.*, Vol. 4, No. 3, 2007, pp. 250–259.
- <sup>23</sup>Tomsic, M., et al., "Development of MgB<sub>2</sub> Superconductor Wire and Coils for Practical Applications," Presented at Cryogenic Engineering Conference, 2015. (Used with permission of M. Tomsic, Hyper Tech Inc., Columbus, OH.)
- <sup>24</sup>Kvitkovic, J., Hatwar, R., and Pamidi, S., "Simultaneous Magnetic Shielding and Magnetization Loss Measurements of YBCO Cylinders at Variable Temperatures Under Cryogenic Helium Gas Circulation," *IEEE Trans. Appl. Supercond.*, Vol. 26, No. 3, 2016, Article Sequence Number: 9000505.
- <sup>25</sup>Dyson, R. W., "NASA Electric Aircraft Testbed (NEAT) Overview," *IEEE Transportation Electrification Newsletter*, March 2017.
- <sup>26</sup>Papathakis, K. V., et al., "NASA Turbo-Electric Distributed Propulsion Bench," *AIAA Propulsion and Energy Forum*, AIAA 2016-4611, AIAA, Reston, VA, 2016.
- <sup>27</sup>Kim, H. D, Felder, J. L., Tong, M. T., and Armstrong, M., "Revolutionary Aeropropulsion Concept for Sustainable Aviation: Turboelectric Distributed Propulsion," *2013 International Society for Air Breathing Engines Meeting*, Busan; Republic of Korea, 2013.
- <sup>28</sup>Kiris, C., Barad, M., Housman, J. A., and Sozer, E., "The LAVA Computational Fluid Dynamics Solver," *52nd AIAA Aerospace Sciences Meeting*, AIAA, Reston, VA, 2014.