



US009713419B2

(12) **United States Patent**
Shahinian et al.

(10) **Patent No.:** **US 9,713,419 B2**
(45) **Date of Patent:** ***Jul. 25, 2017**

(54) **PROGRAMMABLE SPECTRAL SOURCE AND DESIGN TOOL FOR 3D IMAGING USING COMPLEMENTARY BANDPASS FILTERS**

(52) **U.S. Cl.**
CPC *A61B 1/0638* (2013.01); *A61B 1/00193* (2013.01); *A61B 1/045* (2013.01); *A61B 1/0646* (2013.01)

(71) Applicant: **CALIFORNIA INSTITUTE OF TECHNOLOGY**, Pasadena, CA (US)

(58) **Field of Classification Search**
CPC *A61B 1/00193*; *A61B 1/045*; *A61B 1/0646*
(Continued)

(72) Inventors: **Hrayr Karnig Shahinian**, Beverly Hills, CA (US); **Michael J. Shearn**, San Antonio, TX (US); **Youngsam Bae**, Los Angeles, CA (US); **Ronald J. Korniski**, Thousand Oaks, CA (US); **Eric W. Fritz**, Atkinson, NE (US); **Allen Ream**, Anchorage, AK (US)

(56) **References Cited**

U.S. PATENT DOCUMENTS

1,960,011 A 5/1934 Ives
2,255,631 A 9/1941 Shulman
(Continued)

FOREIGN PATENT DOCUMENTS

EP 0469966 B1 2/1992
EP 1371321 A1 12/2003
(Continued)

OTHER PUBLICATIONS

Y.S. Heo, "Illumination and Camera Invariant Stereo Matching," Computer Vision and Pattern Recognition, 2008. CVPR 2008. IEEE Conference, vol., no., pp. 1-8, Jun. 23-28, 2008.

(Continued)

(73) Assignee: **California Institute of Technology**, Pasadena, CA (US)

(*) Notice: Subject to any disclaimer, the term of this patent is extended or adjusted under 35 U.S.C. 154(b) by 0 days.

This patent is subject to a terminal disclaimer.

(21) Appl. No.: **15/082,623**

(22) Filed: **Mar. 28, 2016**

(65) **Prior Publication Data**

US 2016/0206187 A1 Jul. 21, 2016

Related U.S. Application Data

(63) Continuation of application No. 13/628,788, filed on Sep. 27, 2012, now Pat. No. 9,295,375.

(Continued)

(51) **Int. Cl.**

A61B 1/06 (2006.01)
A61B 1/045 (2006.01)
A61B 1/00 (2006.01)

(57) **ABSTRACT**

An endoscopic illumination system for illuminating a subject for stereoscopic image capture, includes a light source which outputs light; a first complementary multiband bandpass filter (CMBF) and a second CMBF, the first and second CMBFs being situated in first and second light paths, respectively, where the first CMBF and the second CMBF filter the light incident thereupon to output filtered light; and a camera which captures video images of the subject and generates corresponding video information, the camera receiving light reflected from the subject and passing through a pupil CMBF pair and a detection lens. The pupil

(Continued)

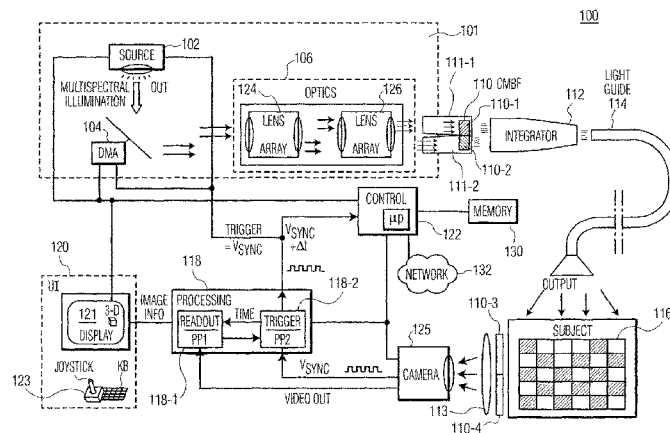

CMBF includes a first pupil CMBF and a second pupil CMBF, the first pupil CMBF being identical to the first CMBF and the second pupil CMBF being identical to the second CMBF, and the detection lens includes one unpartitioned section that covers both the first pupil CMBF and the second pupil CMBF.

22 Claims, 19 Drawing Sheets

Related U.S. Application Data

- (60) Provisional application No. 61/539,808, filed on Sep. 27, 2011.
- (58) **Field of Classification Search**
USPC 348/45
See application file for complete search history.

References Cited

U.S. PATENT DOCUMENTS

3,870,037	A	3/1975	Cadariu et al.
4,651,201	A	3/1987	Schoolman
4,759,348	A	7/1988	Cawood
4,761,066	A	8/1988	Carter
4,873,572	A	10/1989	Miyazaki et al.
4,877,307	A	10/1989	Kalmanash
4,951,676	A	8/1990	Collet-Billon
5,050,226	A	9/1991	Collet-Billon
5,105,269	A	4/1992	Nakamura et al.
5,192,969	A	3/1993	Igarashi et al.
5,222,477	A	6/1993	Lia
5,305,098	A	4/1994	Matsunaka et al.
5,395,030	A	3/1995	Kuramoto et al.
5,436,655	A	7/1995	Hiyama et al.
5,459,605	A	10/1995	Kempf
5,471,237	A	11/1995	Shipp
5,494,483	A	2/1996	Adair
5,536,234	A	7/1996	Newman
5,540,229	A	7/1996	Collet-Billon et al.
5,547,455	A	8/1996	McKenna et al.
5,603,687	A	2/1997	Hori et al.
5,605,532	A	2/1997	Schermerhorn
5,662,584	A	9/1997	Hori et al.
5,667,473	A	9/1997	Finn et al.
5,697,891	A	12/1997	Hori
5,743,847	A	4/1998	Nakamura et al.
5,751,341	A	5/1998	Chaleki et al.
5,782,752	A	7/1998	Lichtman et al.
5,810,716	A	9/1998	Mukherjee et al.
5,817,014	A	10/1998	Hori et al.
5,823,940	A	10/1998	Newman
5,827,323	A	10/1998	Klieman et al.
5,828,487	A	10/1998	Greening et al.
5,835,194	A	11/1998	Morton
5,841,887	A	11/1998	Kuwayama et al.
5,855,549	A	1/1999	Newman
5,895,350	A	4/1999	Hori
5,928,137	A	7/1999	Green
5,935,057	A	8/1999	Lichtman et al.
5,941,817	A	8/1999	Crawford
5,941,818	A	8/1999	Hori et al.
5,944,654	A	8/1999	Crawford
D415,146	S	10/1999	Hori
5,964,696	A	10/1999	Mihalca et al.
5,984,939	A	11/1999	Yoon
5,989,182	A	11/1999	Hori et al.
6,046,727	A	4/2000	Rosenberg et al.
6,050,939	A	4/2000	Pak Wai
6,066,090	A	5/2000	Yoon
6,086,528	A	7/2000	Adair
6,159,146	A	12/2000	El Gazayerli
6,191,809	B1	2/2001	Hori et al.

6,211,848	B1	4/2001	Plesniak et al.
6,223,100	B1	4/2001	Green
6,277,064	B1	8/2001	Yoon
RE37,356	E	9/2001	Hori et al.
6,290,649	B1	9/2001	Miller et al.
6,292,221	B1	9/2001	Lichtman
6,306,082	B1	10/2001	Takahashi et al.
6,313,883	B1	11/2001	Thaler
6,419,626	B1	7/2002	Yoon
6,445,814	B2	9/2002	Lijlma et al.
6,450,948	B1	9/2002	Matsuura et al.
6,450,950	B2	9/2002	Irion
6,517,479	B1	2/2003	Sekiya et al.
6,593,957	B1	7/2003	Christie
6,624,935	B2	9/2003	Weissman et al.
6,647,792	B2	11/2003	Ogawa
6,731,988	B1	5/2004	Green
6,817,973	B2	11/2004	Merril et al.
6,832,984	B2	12/2004	Stelzer et al.
6,916,286	B2	7/2005	Kazakevich
6,976,956	B2	12/2005	Takahashi et al.
6,980,676	B2	12/2005	Pineau
6,991,602	B2	1/2006	Nakazawa et al.
6,997,871	B2	2/2006	Sonnenschein et al.
7,043,062	B2	5/2006	Gerard et al.
RE39,342	E	10/2006	Starks et al.
7,153,259	B2	12/2006	Matsuzawa et al.
7,154,527	B1	12/2006	Goldstein et al.
7,241,262	B2	7/2007	Adler et al.
7,553,277	B2	6/2009	Hoefig et al.
7,601,119	B2	10/2009	Shahinian
7,621,869	B2	11/2009	Ratnakar
2002/0030678	A1	3/2002	Ostermann
2002/0049367	A1	4/2002	Irion et al.
2002/0154215	A1	10/2002	Schechterman et al.
2003/0053744	A1	3/2003	Makio
2003/0125608	A1	7/2003	Igarashi
2003/0174208	A1	9/2003	Glukhovskiy et al.
2003/0233024	A1	12/2003	Ando
2004/0019255	A1	1/2004	Sakiyama
2004/0070667	A1	4/2004	Ando
2004/0249367	A1	12/2004	Saadat et al.
2005/0065657	A1	3/2005	Green
2005/0065658	A1	3/2005	Green
2005/0119530	A1	6/2005	Douglas et al.
2005/0228230	A1	10/2005	Schara et al.
2005/0234296	A1	10/2005	Saadat et al.
2005/0234297	A1	10/2005	Devierre et al.
2005/0261548	A1	11/2005	Machiya et al.
2005/0278711	A1	12/2005	Silva et al.
2006/0015008	A1	1/2006	Kennedy
2006/0111614	A1	5/2006	Saadat et al.
2006/0224040	A1	10/2006	Khait et al.
2006/0247495	A1	11/2006	Bacher et al.
2007/0055103	A1	3/2007	Hoefig et al.
2007/0112256	A1	5/2007	Terakawa
2007/0173689	A1	7/2007	Ozaki et al.
2007/0249932	A1	10/2007	Shahinian
2007/0255100	A1	11/2007	Barlow et al.
2008/0281154	A1	11/2008	Gono et al.
2008/0284982	A1	11/2008	Richards et al.
2009/0137893	A1	5/2009	Seibel et al.
2009/0187072	A1	7/2009	Manohara et al.
2010/0006549	A1*	1/2010	Pahk B23K 26/067 219/121.76
2011/0115882	A1*	5/2011	Shahinian A61B 1/00183 348/45

FOREIGN PATENT DOCUMENTS

EP	1854420	A1	11/2007
EP	1880657	A1	1/2008
EP	1989990	A1	11/2008
JP	04-021105		1/1992
JP	06-202004		7/1994
JP	06-237892		8/1994
JP	10-010468		1/1998
JP	2000-052289		2/2000
WO	93/13916	A1	7/1993

(56)

References Cited

FOREIGN PATENT DOCUMENTS

WO	96/35975	A1	11/1996
WO	99/57900	A1	11/1999
WO	00/50927	A2	8/2000
WO	00/61009	A1	10/2000
WO	0237142	A2	5/2002
WO	03098913	A2	11/2003
WO	2005/030328	A2	4/2005
WO	2005/031433	A1	4/2005
WO	2005/120327	A2	12/2005
WO	2008/033356	A2	3/2008

OTHER PUBLICATIONS

- J.L. Garb, "Using GIS for spatial analysis of rectal lesions in the human body," *International Journal of Health Geographics*, 2007, 6:11, Published online Mar. 15, 2007. doi: 10.1186/1476-072X-6-11. PMID: PMC1839078 BioMed Central Ltd.
- J.P. Rice, "A hyperspectral image projector for hyperspectral imagers," *SPIE* vol. 6565 65650C, (2007).
- J.P. Rice, "Hyperspectral image projectors for radiometric applications," *BIPM and IOP Publishing Ltd, Metrologia* 43 (2006) S61-S65.
- J.P. Rice, "Development of hyperspectral image projectors," *SPIE* vol. 6297, 629701, (2006).
- J.M. Medina, "Binocular interactions in random chromatic changes at isoluminance," *Opt. Soc. Am.*, 2006, vol. 23, No. 2, pp. 239-246.
- A. Szold, "Seeing is believing—Visualization systems in endoscopic surgery (video, HDTV, stereoscopy, and beyond)," *Surgical Endoscopy*, 19:55, pp. 730-733, Springer, 2005.
- J. D. A Mueller-Richter, "Possibilities and limitations of current stereo-endoscopy," *Journal of Surgical Endoscopy*, Springer, New York, ISSN 0930-2794 (Print) 1432-2218 (Online) Issue vol. 18, No. 6, Jun. 2004, 18: pp. 942-947.
- M.A. Weissman, "Stereo parallax and Disparity in Single-Lens Stereoscopy," *Stereoscopic Displays and Virtual Reality Systems VII*, *SPIE* 3987, pp. 312-320, Apr. 2000.
- G.A. Lester, "Ferroelectric liquid crystal device for a single camera endoscopic endoscope system," *Electronics Letters*, 1997, vol. 33, No. 10, pp. 857-858.
- G.L. Zimmerman, "Perception at Equiluminance: An Adaptive Model of Motion Metamers," *Circuits and Systems*, 1994., *Proceedings of the 37th Midwest Symposium on*, vol. 1, no., pp. 577-580 vol. 1, Aug. 3-5, 1994.
- Y. Takemura, "Stereoscopic Video Movie Camera Using 300k Pixel IT-CCD Sensors," *IEEE Transactions on Consumer Electronics*, Feb. 1991, vol. 37, No. 1, pp. 39-44.
- E. Badique, "Use of color image correlation in the retrieval of gastric surface topography by endoscopic stereopair matching," *Applied Optics*, 1988, vol. 27, No. 5, pp. 941-948.
- N. Ohyama, "Compensation of motion blur in CCD color endoscope images," *Opt. Soc. Am.*, 2006, *Applied Optics*, 1987, vol. 26, No. 5, pp. 909-912.
- P. Breedveld and M. Wentink, "Eye-hand coordination in laparoscopy—an overview of experiments and supporting aids," *Min Invas Ther & Allied Technol* 2001: 155-162, 10(3).
- Keijirou Itakura, et al., "A 1-mm 50 k-Pixel IT CCD Image Sensor for Miniature Camera System," *IEEE Transactions on Electron Devices*, Jan. 2000, 65-70, vol. 47, No. 1.
- Jacques Duparré, et al., "Thin compound-eye camera," *Applied Optics*, May 20, 2005, pp. 2949-2956, vol. 44, No. 15.
- Jun Tanida, et al., "Color imaging with an integrated compound imaging system," *Optics Express*, Sep. 8, 2003, 2019-2117, vol. 11, No. 18.
- Jun Tanida, et al., "Thin observation module by bound optics (TOMBO): concept and experimental verification," *Applied Optics*, Apr. 10, 2001, 1806-1813, vol. 40, No. 11.
- Ikeda, M., Sagawa, K., "Binocular color fusion limit," *J. of the Optical Society of America*, 69(2), 316-321, (Feb. 1979).
- Dudley, D., Duncan, W. M., Slaughter, J., "Emerging digital miromirror device (DMD) applications," *Proceedings of SPIE* 4985, 14-25 (2003).
- Hovis, J. K., "Review of Dichoptic Color Mixing," *Optometry and Vision Science*, 66(3), 181-190 (1998).
- Lambooj, M., Ijsselstein, W., "Visual discomfort and visual fatigue of stereoscopic display: A review," *J. of Imaging science and technology*, 53(3), 030201 (2009).
- DooHyun Lee and InSo Kweon, "A Novel Stereo Camera System by a Biprism," *IEEE Transactions on Robotics and Automation*, 16(5), 528-541, (Oct. 2000).
- Mikko Kyto, Mikko Nuutinen, Pirkko Oittinen, "Method for measuring stereo camera depth accuracy based on stereoscopic vision," *OAalto University School of Science and Technology, Department of Media Technology, Otaniementie 17, Espoo, Finland*.
- Qin, D., Takamatsu, M., Nakashima, Y., Qin, X., "Change of wavelength difference limit for binocular color fusion with wavelength and brightness of stimuli," *J. of Light and Visual Environment*, 30(1), 43-45 (2006).
- Jung, Y. J., Sohn, H., Lee, S., Ro, Y. M., and Park, H. W., "Quantitative measurement of binocular color fusion limit for non-spectral colors," *Optics express*, 19(8), 7325-7338 (2011).
- Planar Systems Inc., "SD1710 Product User's Guide," 1-12 (2005).
- CRI Varispec, "Liquid Crystal Tuneable Filters," 1-12 (2005).
- Avi Yaron, Mark Shechterman and Nadav Horesh, "Blur spot limitations in distal endoscope sensors," *Proc. SPIE* 6055, *Stereoscopic Displays and Virtual Reality Systems XIII*, 605509 (Jan. 27, 2006).
- Researchers Work on Snake-Like 'Rescue Robots', downloaded on Apr. 20, 2006 from http://www.foxnews.com/printer_friendly_story/O,3566,192430,00.htm.
- NASA Infrared Camera Helps Surgeons Map Brain Tumors, Jul. 15, 2004, downloaded on Apr. 24, 2006 from <http://www.jpl.nasa.gov/news/news.cfm?release=20D4-183>.
- Fung et al., "A Case Study of 3D Stereoscopic VS. 2D Monoscopic Tele-Reality in . . ." *IEEE/RSJ International Conference on Intelligent Robots and Systems*, 2005, pp. 181-186.
- Nain et al., "Three-Dimensional Nanoscale Manipulation and Manufacturing Using Proximal Probes: Controlled Pulling of Polymer . . ." *IEEE Int Conf Rob Autom* vol. 1, 2004, pp. 434-439.
- Lytle et al., *Adapting a Teleoperated Device for Autonomous Control Using Three-Dimensional Positioning sensors: . . . Automation in Construction*, vol. 13, 2004, pp. 101-118.
- Mezouar et al., *Robustness of Central Catadioptric Image-based Visual . . .* • *IEEE RSJ Int. Conf. Intell Robots and Syst. IROS*, vol. 2, Sep. 28-Oct. 2, 2004, Sendai, JP, pp. 1389-1394.
- Murakami et al., "Automatic Insertion Work. Based on Visual Measurement and Contact Force Estimation" *Proc IEEE Int Conf Rob Autom*, vol. 4, May 2002, pp. 4167-4172.
- Trivedi et al., "A Vision System for Robotic Inspection and Manipulation", DE90 005412, Univ of Tennessee, Revised Mar. 1989. pp. 1-12.
- Nguyen et al., "30 Model Control of Image Processing" In *JPL, California Inst. of Tech., Proceedings of the NASA Conference on Space Telerobotics*, vol. 3, pp. 213-222 May 2000.
- Stiel et al. *Digital Flashing Tomosynthesis: A Promising Technique for Angiocardigraphic Screening* *IEEE Transactions on Medical Imaging*, Jun. 1993, No. 2, NY, pp. 314-321.
- Fritz, Eric., "High Speed Generation of Illumination Spectra for a Stereoscopic Endoscope", <http://hdl.handle.net/2014/42272>, NASA Undergraduate Student Research Program (USRP), Pasadena, California, Aug. 9, 2011, pp. 1-8, Retrieved from Internet: URL: <http://trs-new.jpl.nasa.gov/dspace/bitstream/2014/42272/1/11-3811.pdf>.
- Ream, Allen, "Project report: reducing color rivalry in imagery for conjugated multiple bandpass filter based stereo endoscopy", <http://hdl.handle.net/2014/42276>, NASA Undergraduate Student Research Program (USRP), Pasadena, California, Aug. 2011, pp. 1-9, Retrieved from Internet: URL: <http://trs-new.jpl.nasa.gov/dspace/bitstream/2014/42276/1/11-3803.pdf>.
- J.P. Rice et al., "Hyperspectral image compressive projection algorithm," *SPIE* vol. 7334 pp. 733414-1, , XP055046293, ISSN: 0277-786X, DOI: 10.1117/12.818844, (Apr. 27, 2009).

(56)

References Cited

OTHER PUBLICATIONS

Sam Bae et al, "Toward a 3D endoscope minimally invasive surgery", SPIE Newsroom, Sep. 21, 2011, pp. 1-3, XP055046098, DOI: 10.1117/2.1201109.003810.

NASA's Jet Propulsion Laboratory et al: "Stereo Imaging Miniature Endoscope", Internet Citation, Jun. 30, 2011 (Jun. 30, 2011), pp. 6-7, XP002687431, Retrieved from the Internet: URL:http://ntrs.nasa.gov/archive/nasa/casi.ntrs.nasa.gov/20110012587_2011013131.pdf [retrieved on Dec. 3, 2012].

Ronald Korniski et al: "3D imaging with a single-aperture 3-mm objective lens: concept, fabrication, and test", Proceedings of SPIE, vol. 8144, Sep. 14, 2011 (Sep. 14, 2011), p. 812904, XP055046246, ISSN: 0277-786X, DOI: 10.1117/12.894110.

* cited by examiner

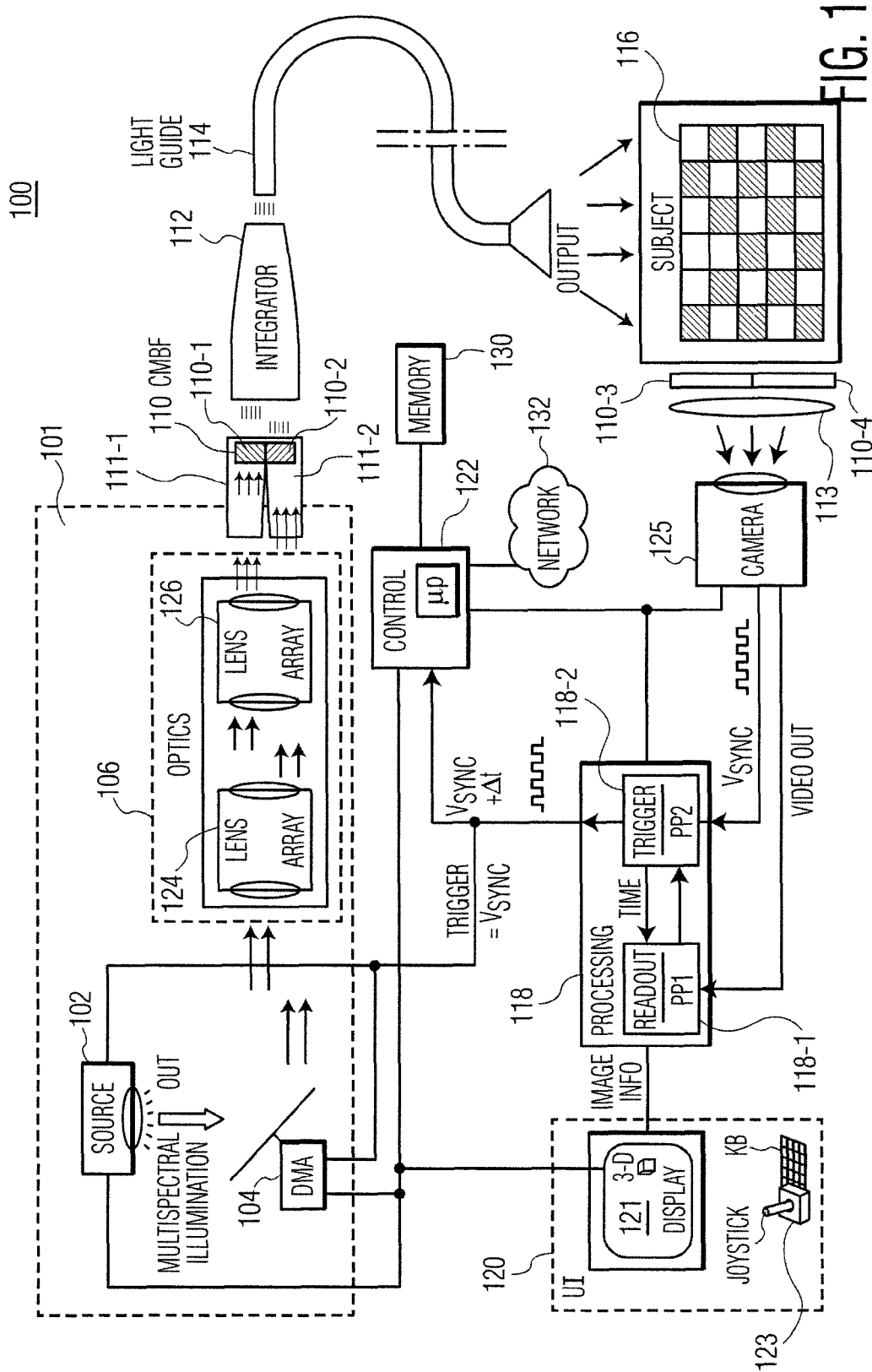

FIG. 1

200

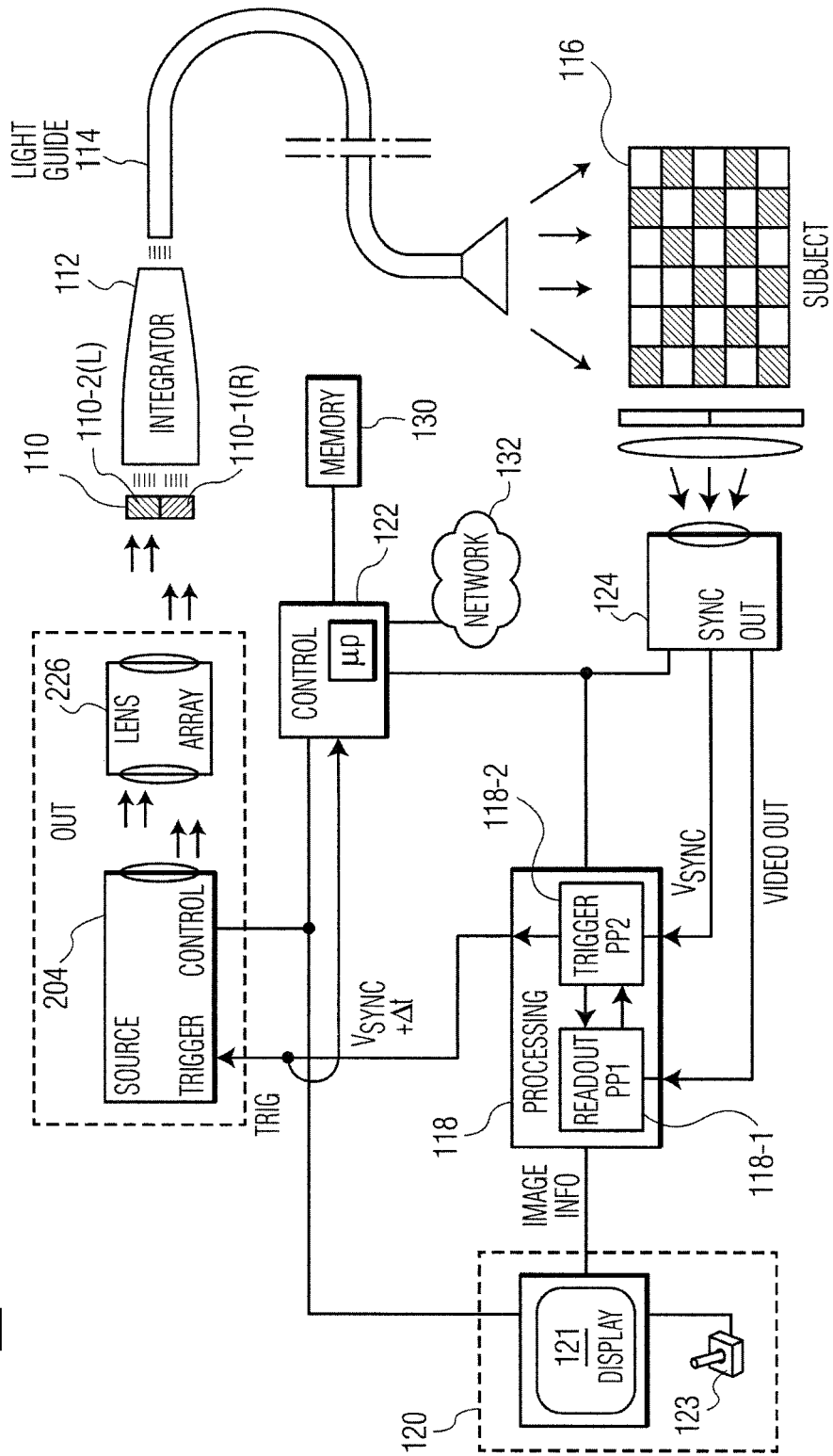

FIG. 2

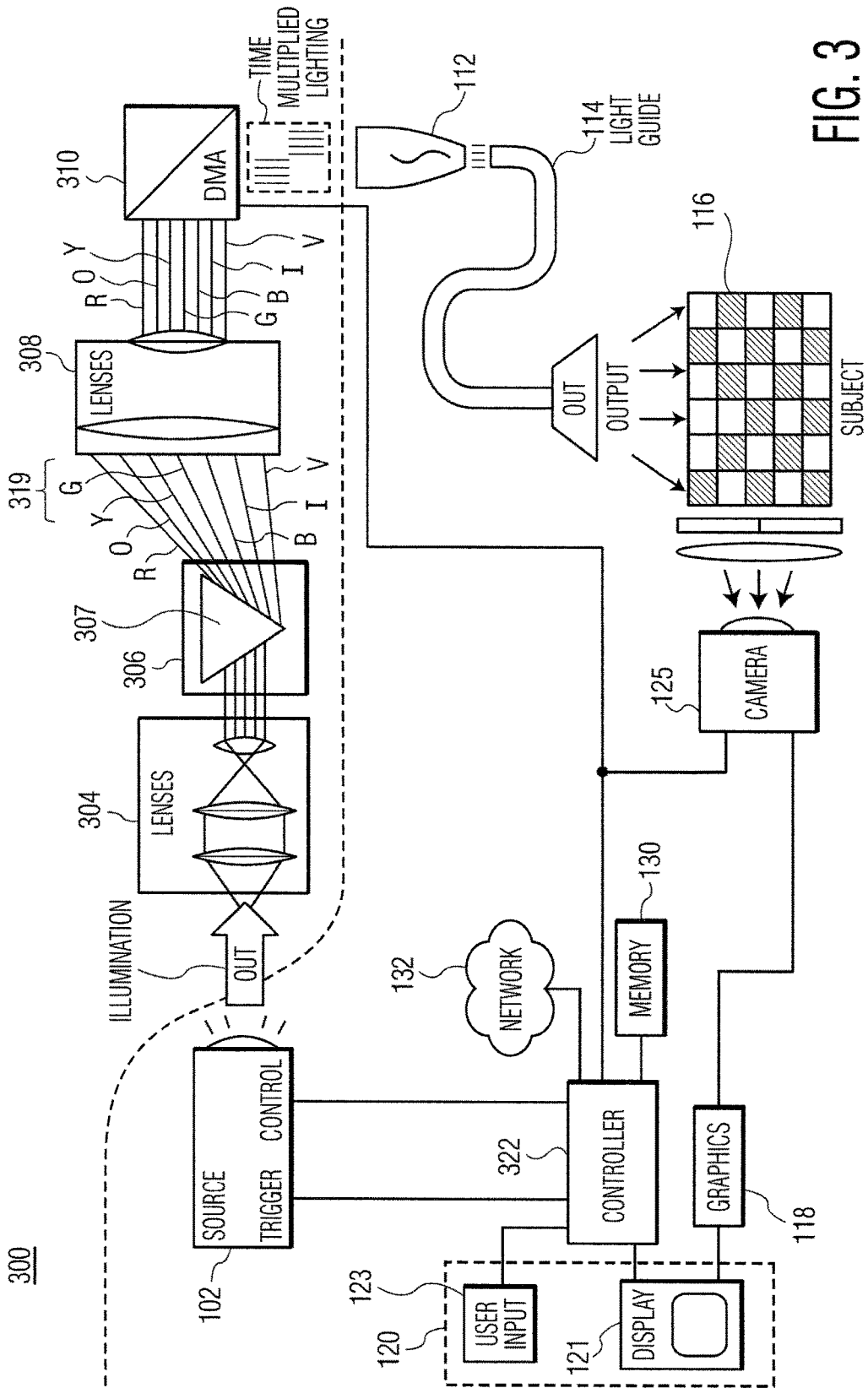

FIG. 3

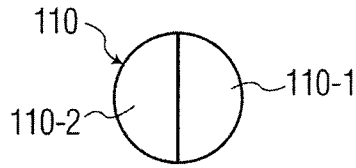

FIG. 4A

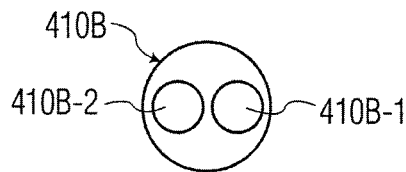

FIG. 4B

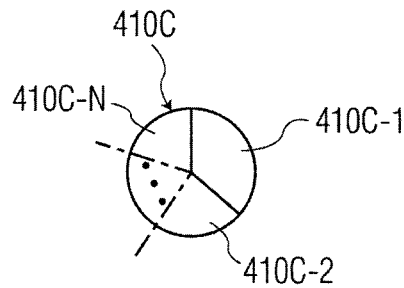

FIG. 4C

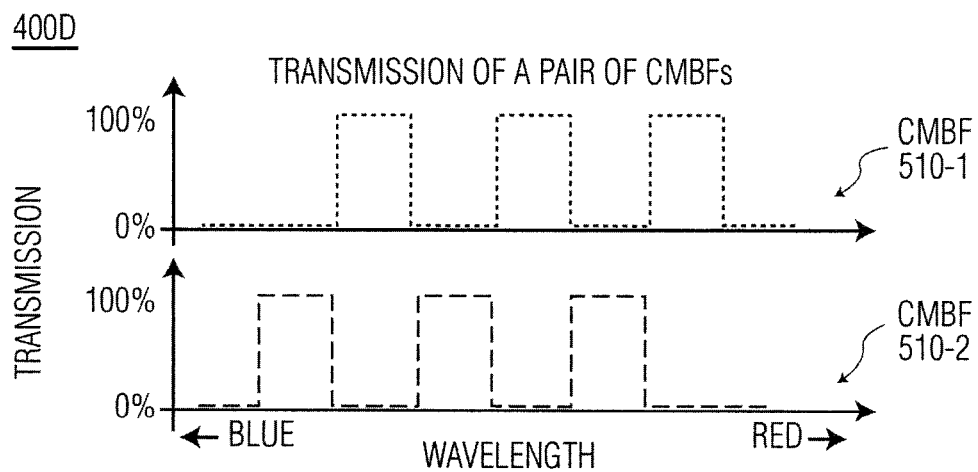

FIG. 4D

500A

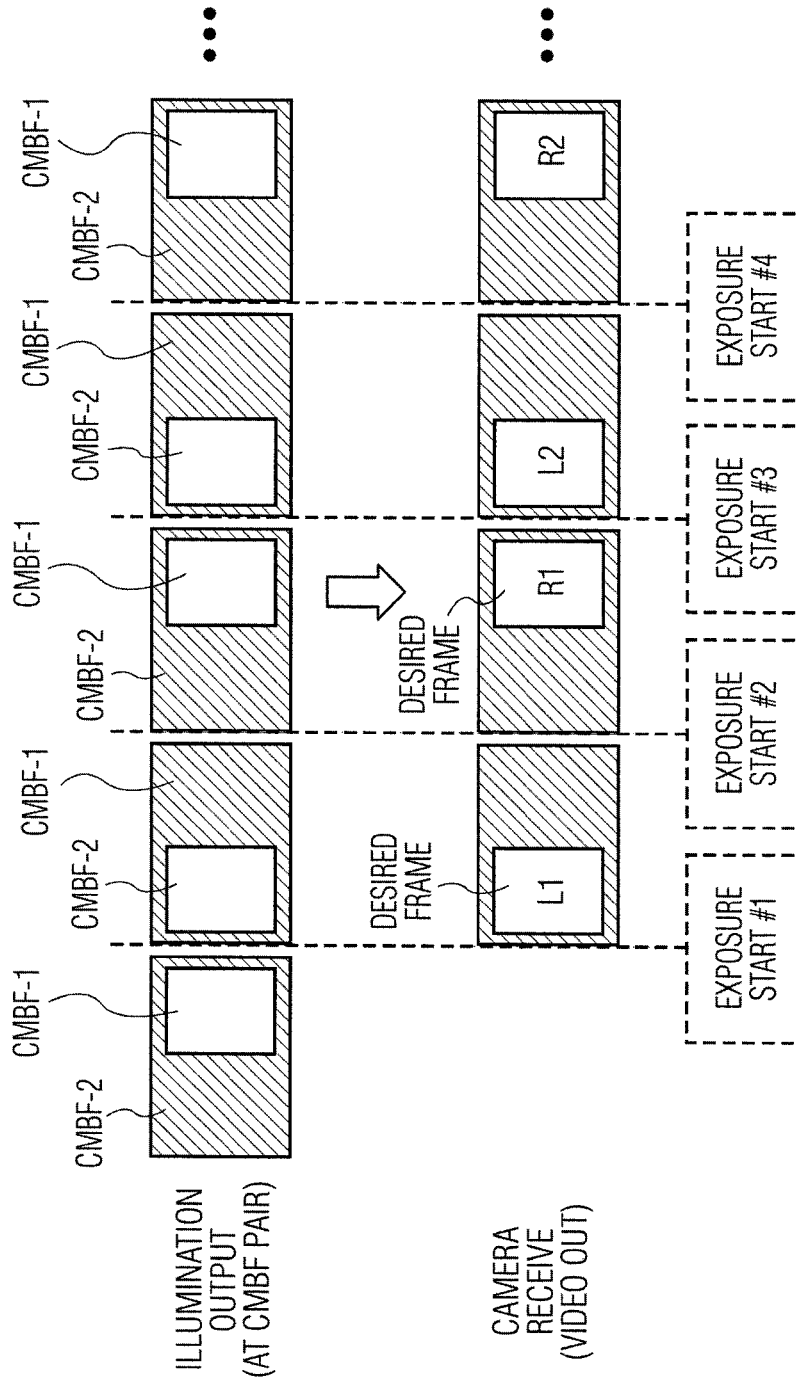

FIG. 5A

500B

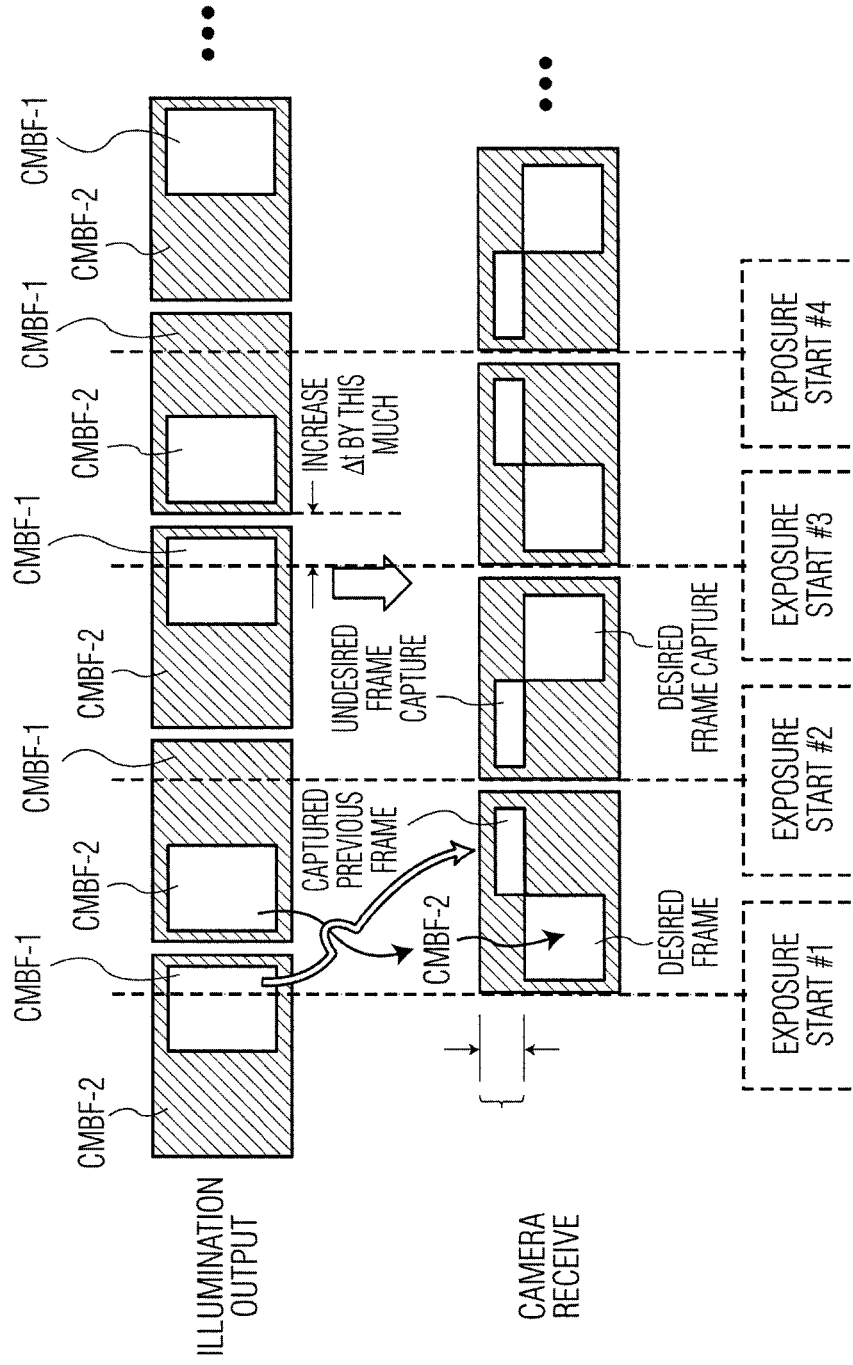

FIG. 5B

500C

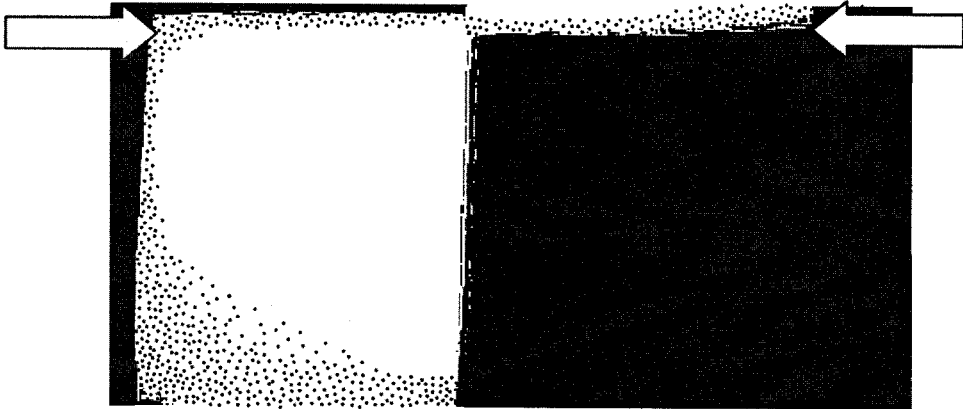

FIG. 5C

500D

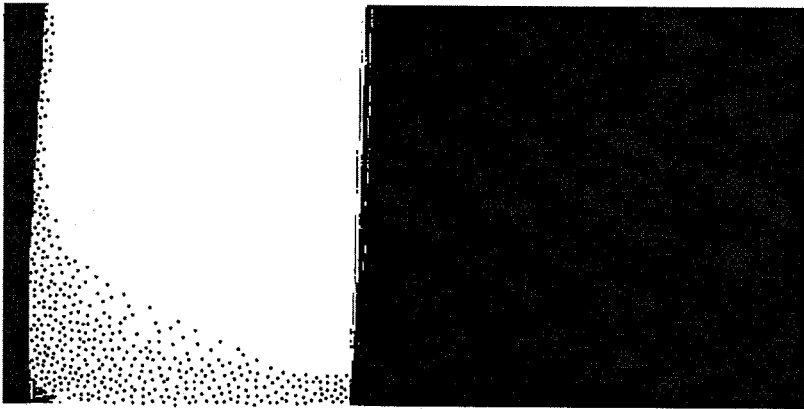

FIG. 5D

600A

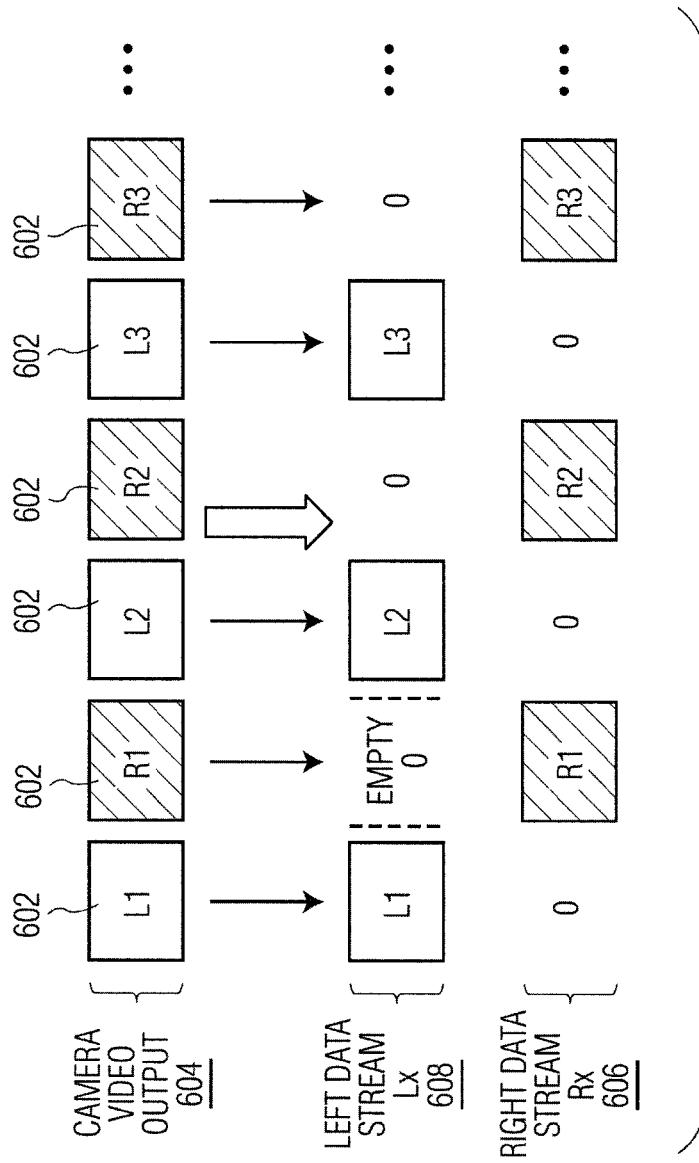

FIG. 6A

600B

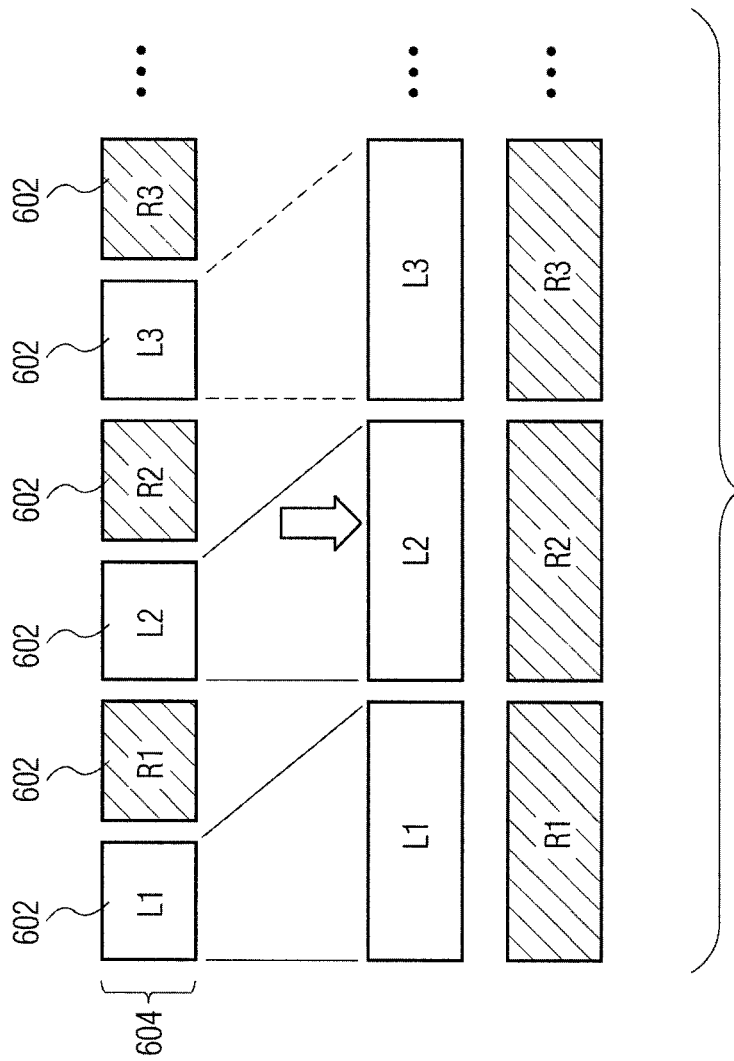

FIG. 6B

600C

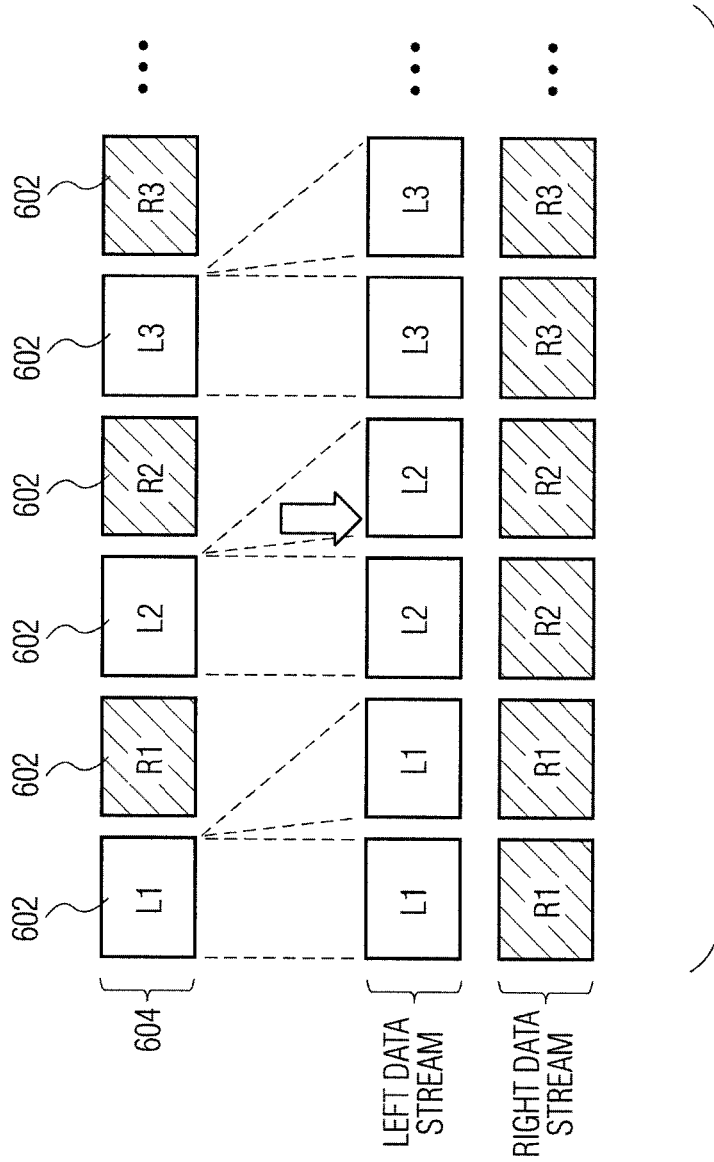

FIG. 6C

600D

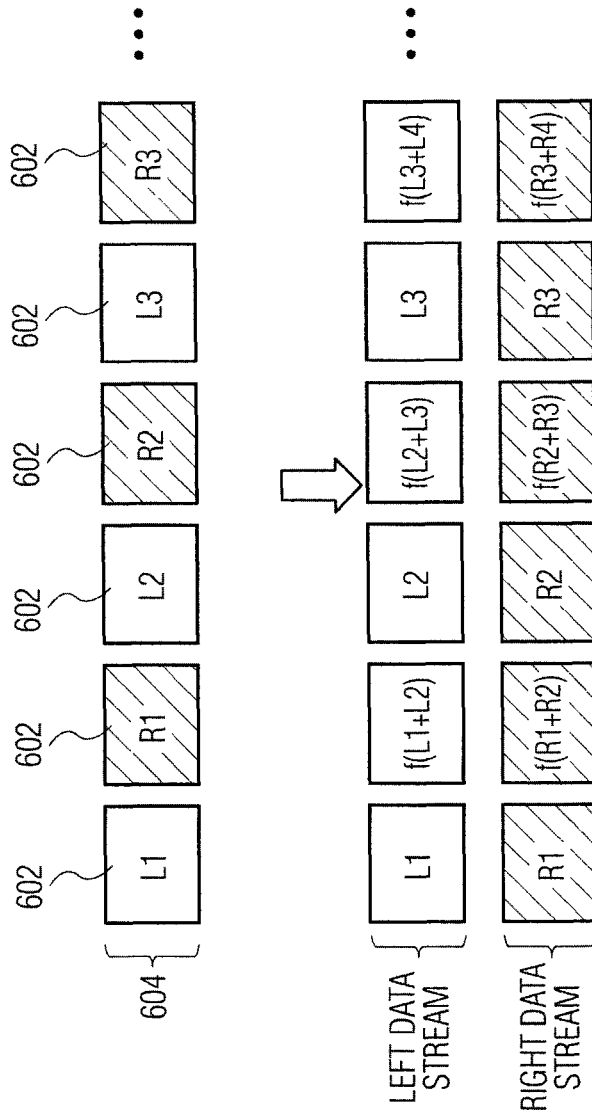

FIG. 6D

CORRECTED DATA

BRADFORD TRANSFORMATION

RAW SENSOR DATA

$$\begin{bmatrix} 24,60 \\ 23,40 \\ 34,54 \end{bmatrix}_{D50} = \begin{bmatrix} 1,0478 & 0,0229 & -0,0501 \\ 0,0295 & 0,9905 & -0,0171 \\ -0,0092 & 0,0150 & 0,7521 \end{bmatrix} \begin{bmatrix} 25,15 \\ 23,66 \\ 45,76 \end{bmatrix}_{D65}$$



FIG. 7

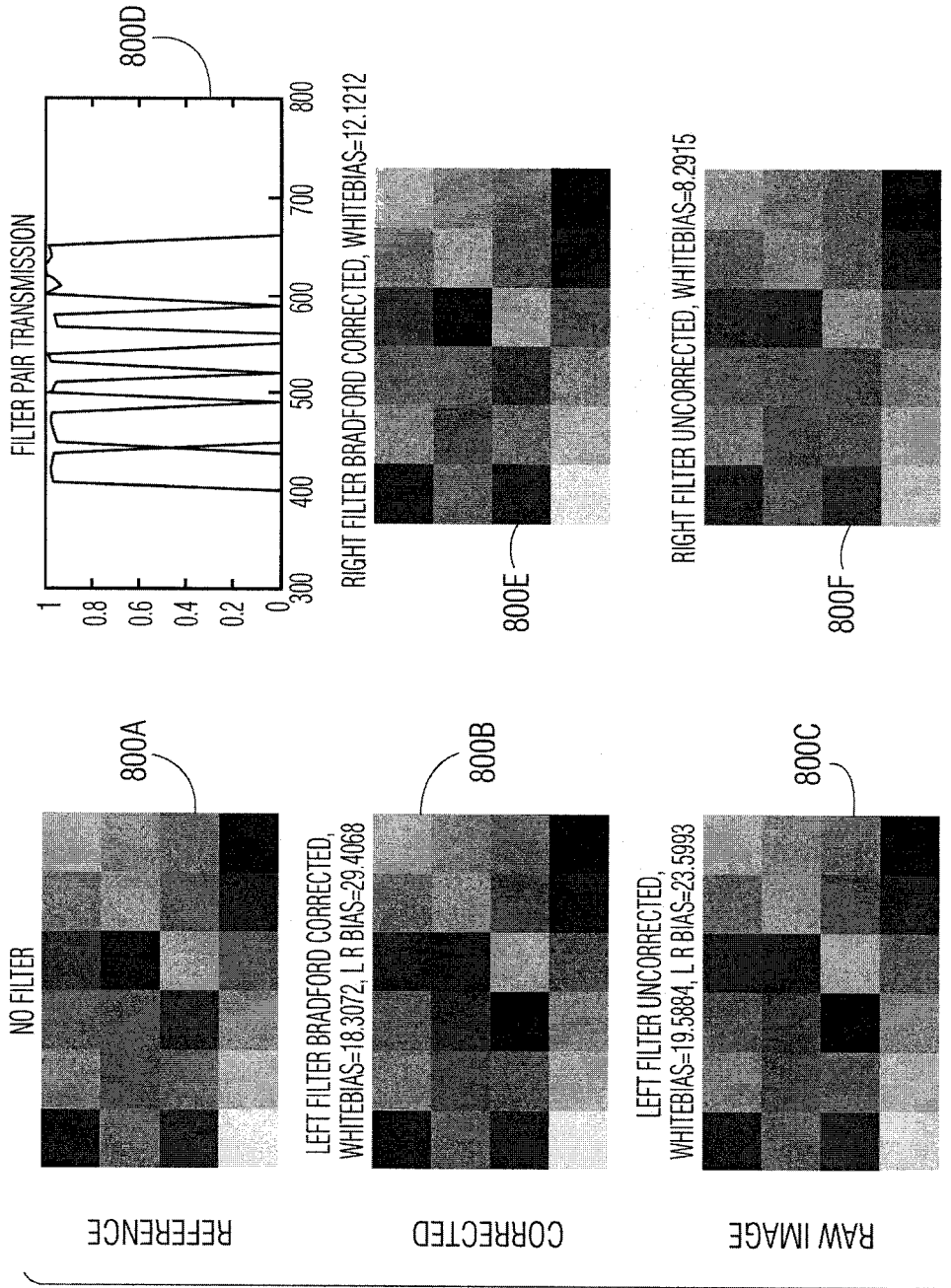

FIG. 8

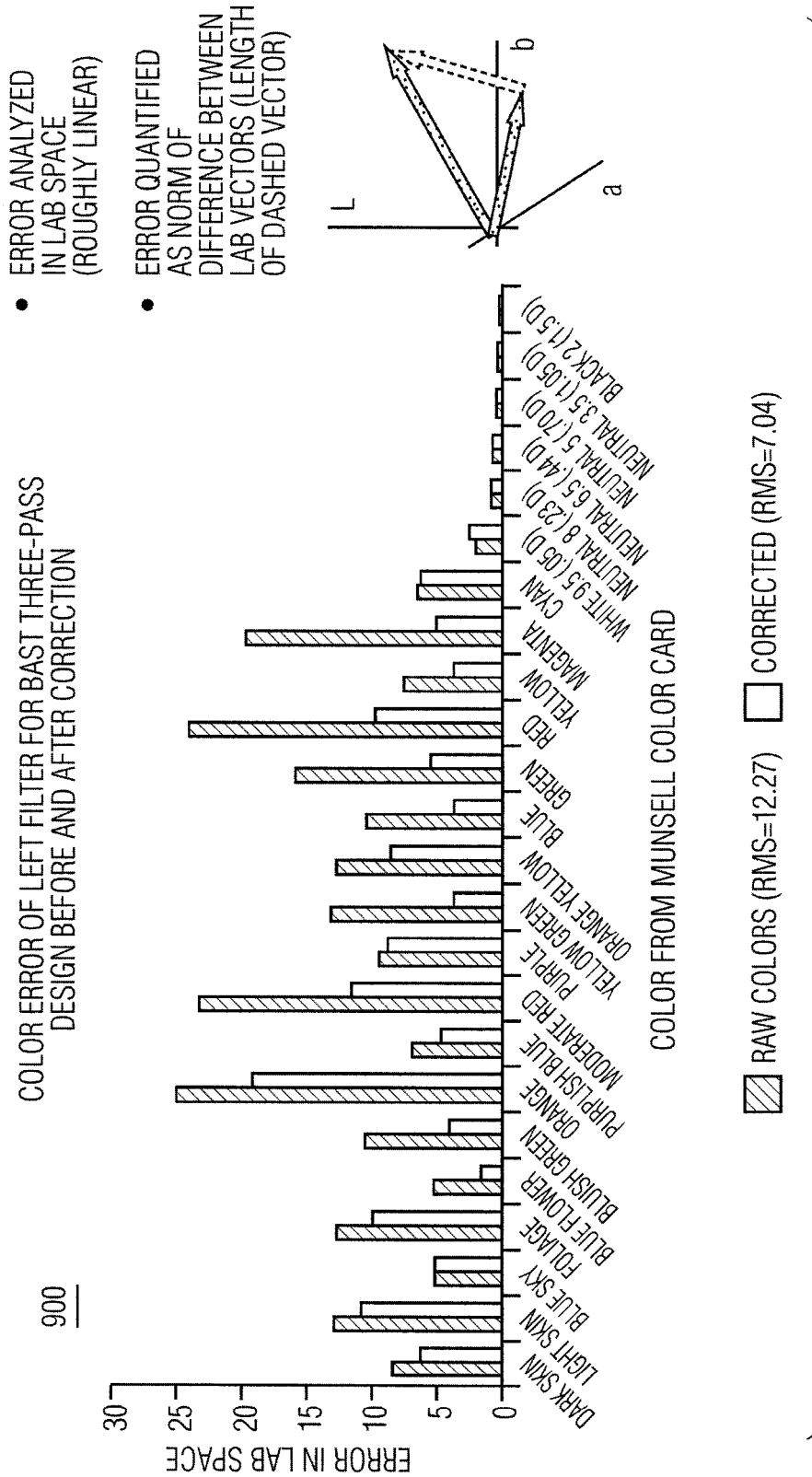
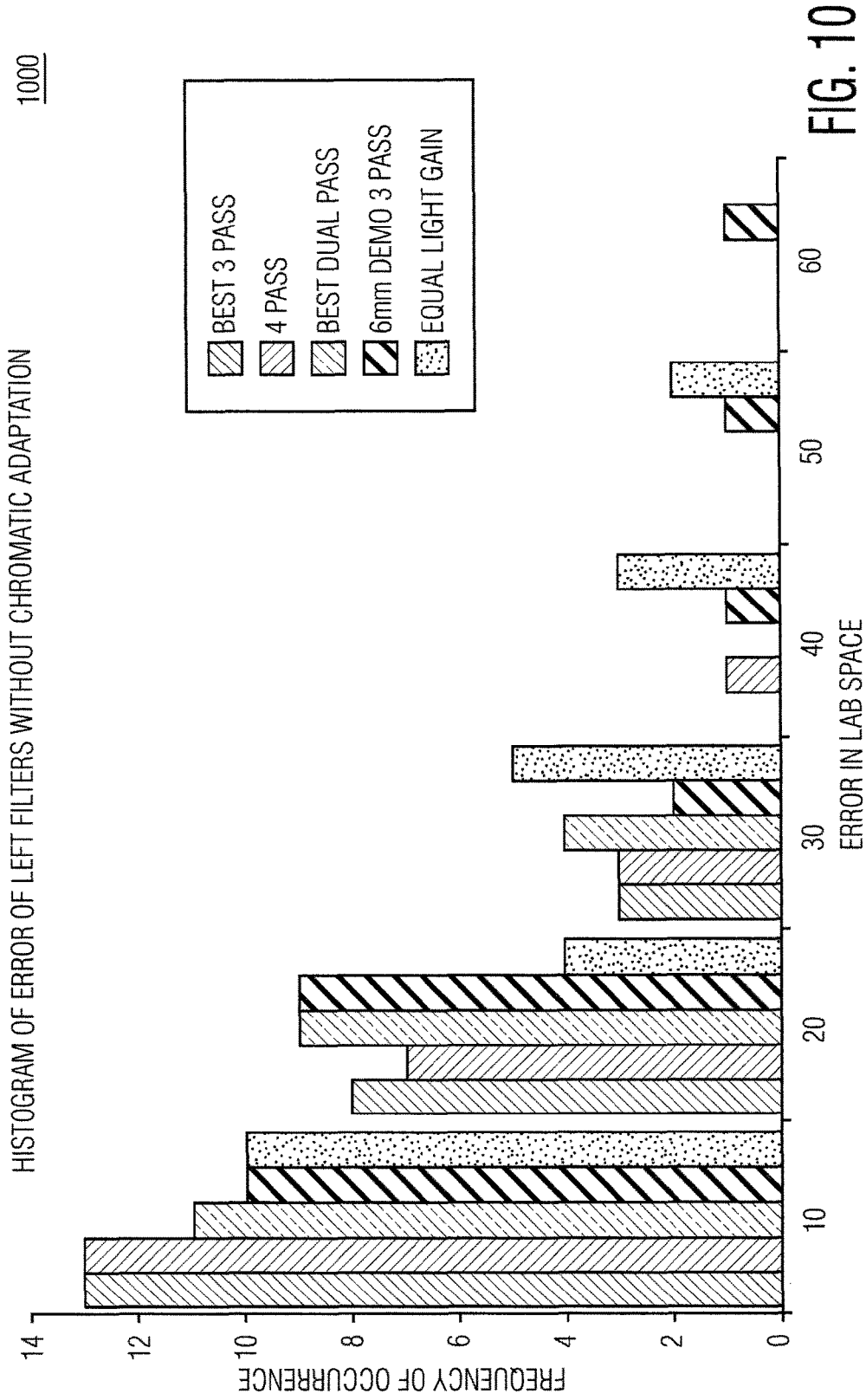

FIG. 9



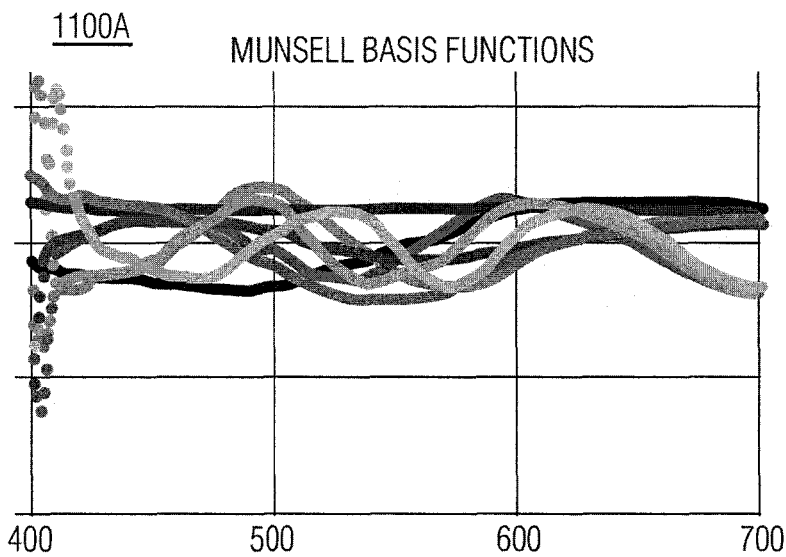

FIG. 11A

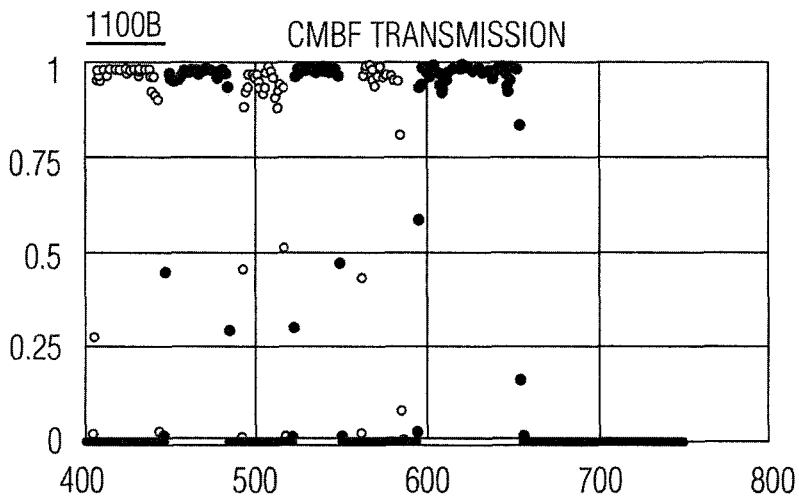

FIG. 11B

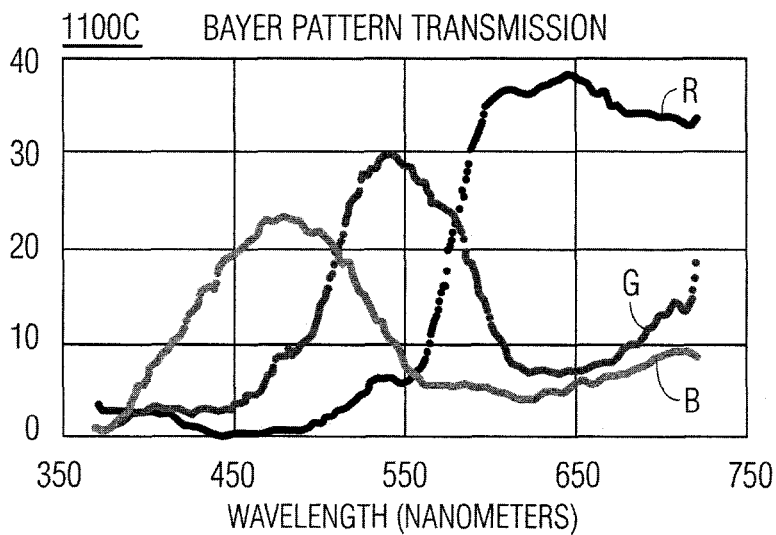

FIG. 11C

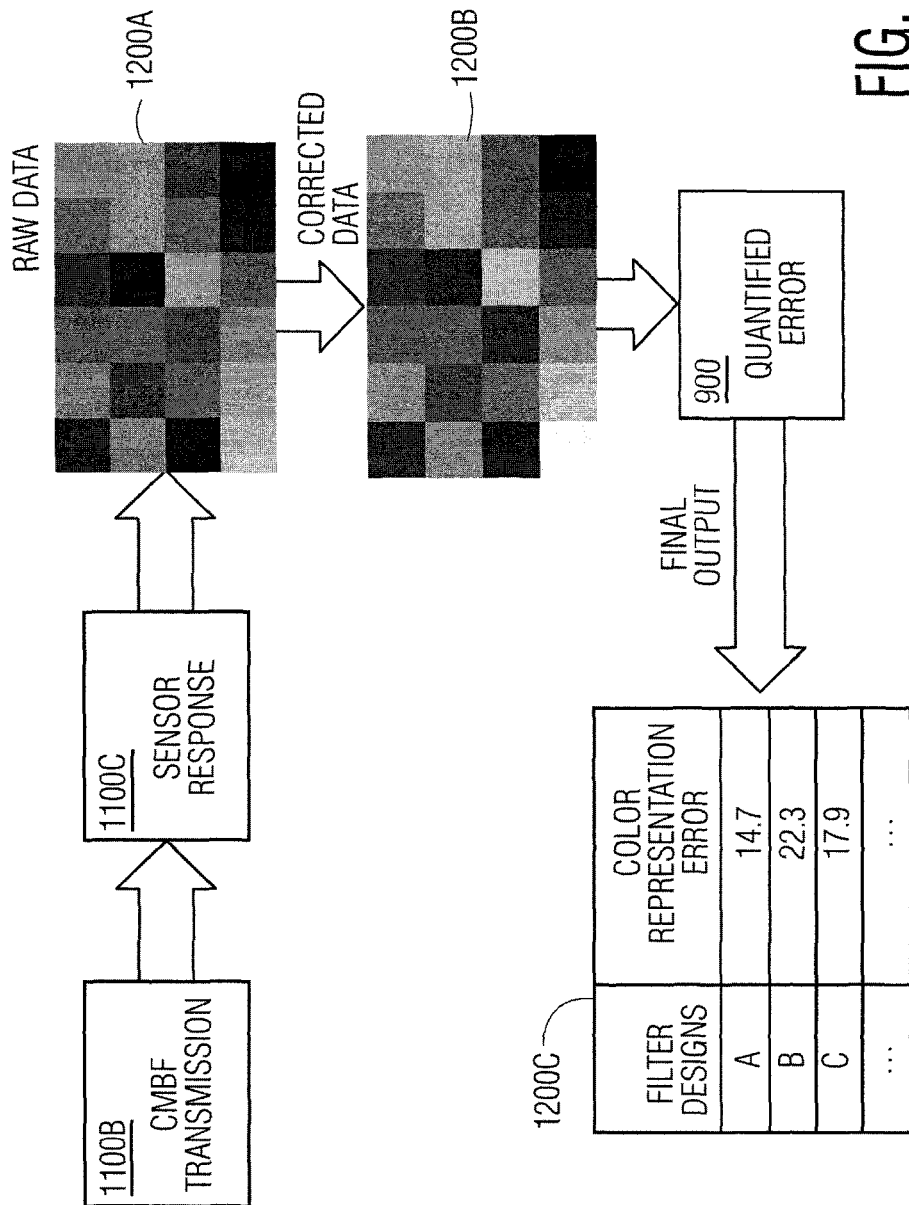

FIG. 12

1300

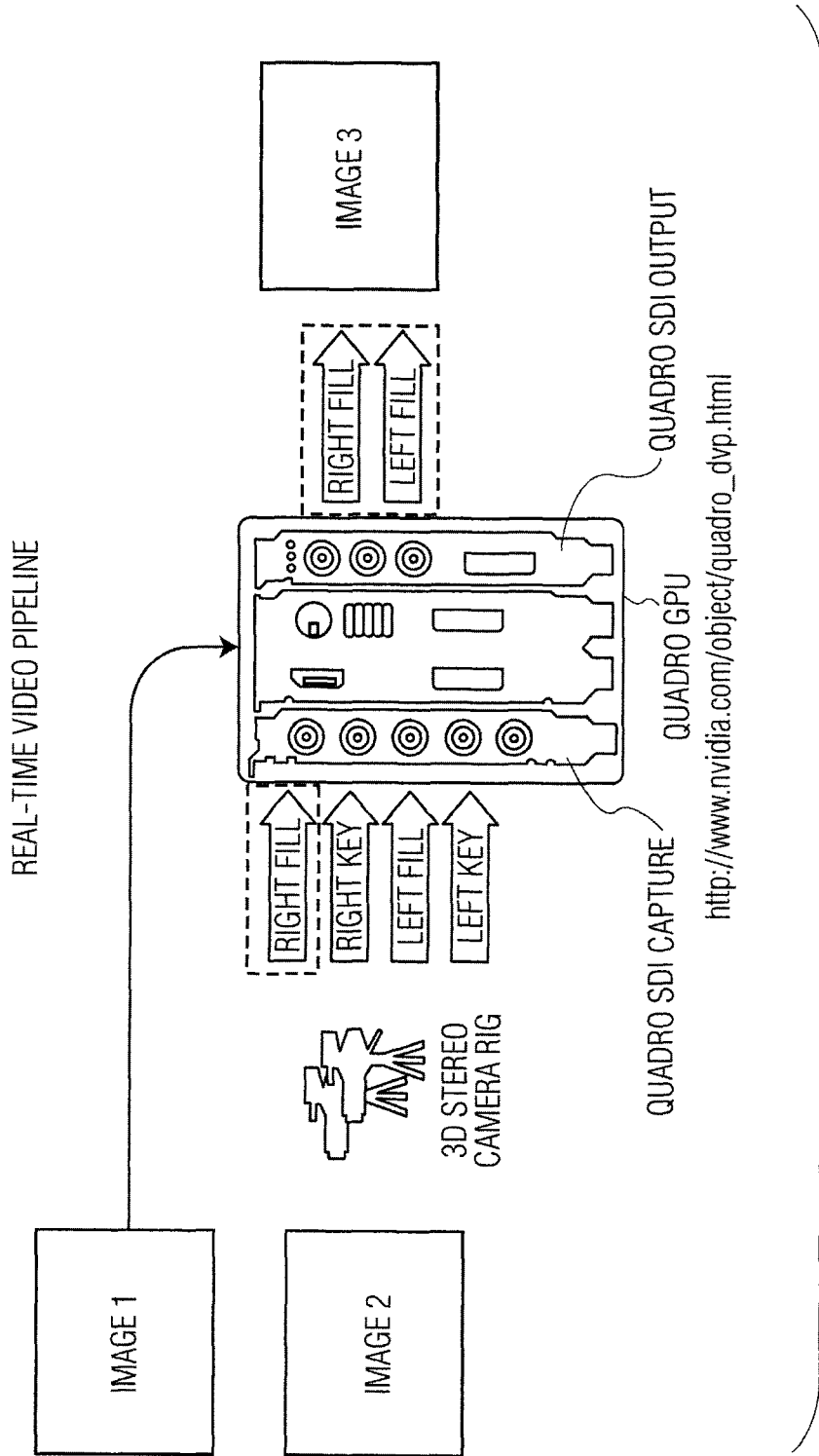

FIG. 13

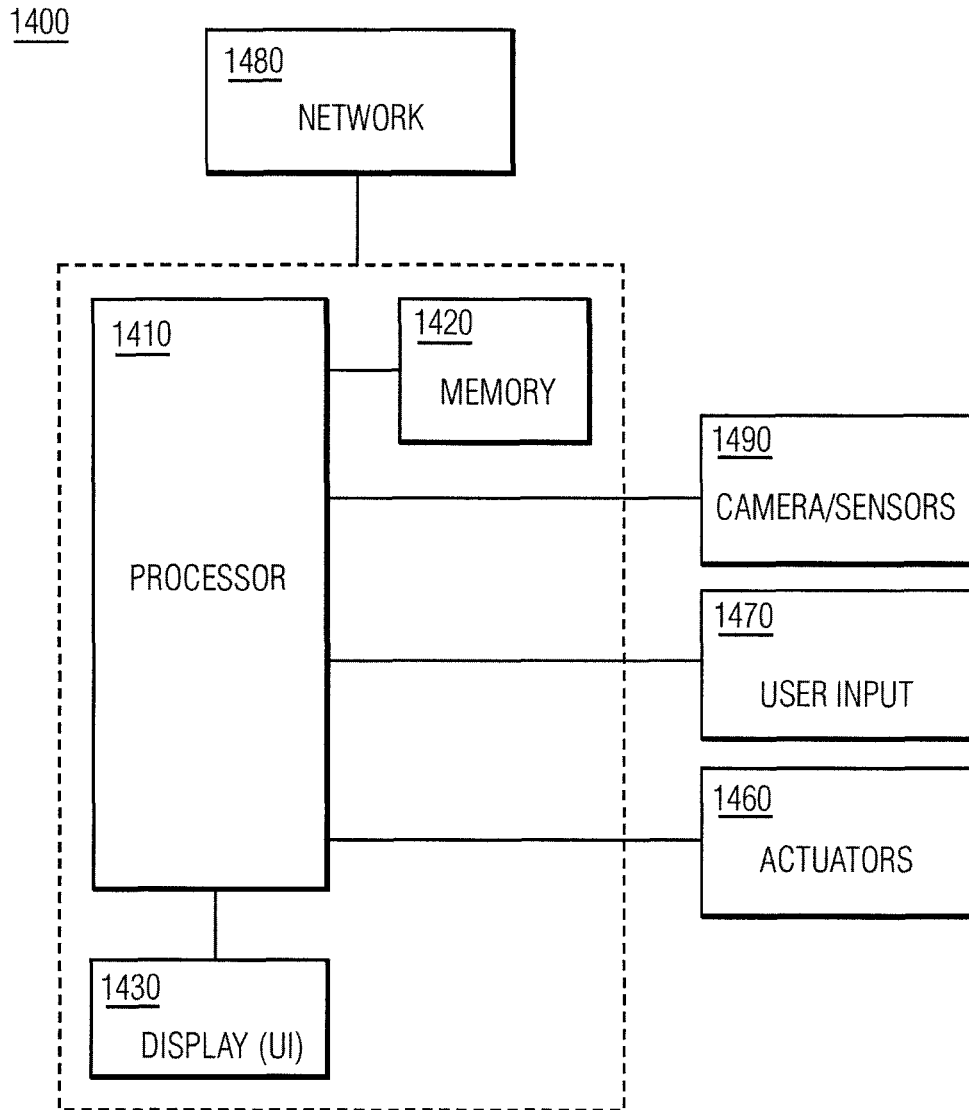

FIG. 14

**PROGRAMMABLE SPECTRAL SOURCE
AND DESIGN TOOL FOR 3D IMAGING
USING COMPLEMENTARY BANDPASS
FILTERS**

This application is a continuation of prior U.S. patent application Ser. No. 13/628,788, filed Sep. 27, 2012, now which issued as U.S. Pat. No. 9,295,375, on Mar. 29, 2016, which claims the benefits of U.S. Provisional Patent Application Ser. No. 61/539,808 filed Sep. 27, 2011, the entire contents of each of which are incorporated herein by reference thereto.

The invention described herein was made in the performance of work under a NASA contract NNN₁₂AA₀₁C, and is subject to the provisions of Public Law 96-517 (35 USC 202) in which the Contractor has elected to retain title.

Further, each of the following patents or patent applications is incorporated herein by reference in its entirety:

(1) U.S. Pat. No. 7,601,119 B2, to Shahinian, entitled "Remote Manipulator with Eyeballs," filed on Apr. 25, 2006 and issued on Oct. 13, 2009;

(2) U.S. Patent Application Publication No. 2009/0187072 A1 to Manohara, et al., entitled "Endoscope and System and Method of Operation thereof," filed on Dec. 18, 2008, and issued as U.S. Pat. No. 8,323,182 on Dec. 4, 2012;

(3) U.S. Patent Application Publication No. 2011/0115882 A1, to Shahinian, et al., entitled "Stereo Imaging Miniature Endoscope with Single Imaging Chip and Conjugated Multi-Bandpass Filters," filed on Nov. 15, 2010; and

(4) U.S. patent application Ser. No. 13/628,896 filed on Sep. 27, 2012, and published as U.S. Patent Application Publication No. 2014/0088361, to Shahinian, et al., claiming priority to U.S. Provisional Patent Application Ser. No. 61/539,842 filed on Sep. 27, 2011, entitled "Multi-Angle Rear-Viewing Endoscope and Method of Operation Thereof"

The present system relates generally to an illumination system for medical imaging systems and, more particularly, to an illumination system for endoscopes capable of capturing stereoscopic images, and a method of operation thereof.

Minimally invasive surgery (MIS) includes surgical and other procedures which are typically less invasive than traditional open procedures such as, for example, conventional open surgery. A MIS procedure usually involves the manipulation of one or more endoscopic devices that can be inserted through an opening or incision and an endoscope or the like to observe a surgical area (or field). Unfortunately, conventional two-dimensional endoscopic viewing systems do not convey depth information of a surgical volume of interest (VOI) which may be provided by stereoscopic endoscopic (i.e., 3D) viewing systems. Accordingly, to enhance a depth-of-field of captured images of a surgical VOI, surgeons may rely upon stereoscopic endoscope imaging systems. However, conventional stereoscopic endoscopic viewing systems require bulky optical switching elements and are unsuitable use in small-diameter endoscopes such as scopes having an outer diameter of about 5 mm or less. Further, conventional techniques to produce stereoscopic images are unreliable, and difficult and costly to operate. Accordingly, the present system provides a novel, reliable, easy to operate, and inexpensive stereoscopic imaging system.

Embodiments of the present system, device(s), method, user interface, computer program, etc., (hereinafter each of which will be referred to as system unless the context indicates otherwise) described herein address problems in prior art systems. In accordance with embodiments of the

present system, disclosed are systems and methods for to illuminate a subject (e.g., a volume of interest, a patient, a surgical zone, a surgical area, an area of interest, etc.) for capturing and viewing of 2-dimensional (2D) and 3-dimensional (3D) stereoscopic images.

In accordance with an aspect of the present system, there is disclosed an endoscopic illumination system for illuminating a subject for stereoscopic image capture, the illumination system comprising: a light source which outputs multi-spectral light; first and second light paths configured to transmit the multi-spectral light; a first complementary multiband bandpass filter (CMBF) and a second CMBF, the first CMBF being situated in the first light path and the second CMBF being situated in the second light path, wherein the first CMBF and the second CMBF filter the multi-spectral light incident thereupon to output filtered light towards the subject for reflection as reflected light; and a camera which captures video images of the subject and generates corresponding video information and a synchronization signal, the video information including a plurality of left and right image frame information, the camera receiving the reflected light reflected from the subject and passing through a pupil CMBF pair and a detection lens. The pupil CMBF includes a first pupil CMBF and a second pupil CMBF, the first pupil CMBF being identical to the first CMBF and the second pupil CMBF being identical to the second CMBF, and the detection lens includes one unpartitioned section that covers both the first pupil CMBF and the second pupil CMBF. The endoscopic illumination system further includes a digital mirror array (DMA) which receives the multi-spectral light and directs the multi-spectral light to a selected light path of one of the first and second light paths; and a controller which controls the DMA to direct the multi-spectral light to the selected light path in accordance with a time-multiplexing scheme.

The system may include an optics portion which may receive the multi-spectral light from the DMA and collimates the multi-spectral light which is to be incident on the selected first or second CMBFs. The system may further include transport optics which integrates the filtered light from the selected first or second CMBFs and transmits the filtered light along a third light path to illuminate the subject. Further, the system may include a synchronizer which determines a delay interval Δt in accordance with the plurality of left and right image frame information and generates a trigger signal in accordance with the synchronization signal and the delay interval Δt for each of the left and right image frames. Moreover, the DMA may control timing of illumination to the selected one of the first or second light paths in accordance with the trigger signal.

In accordance with yet another aspect of the present system, there is disclosed an endoscopic illumination method for illuminating a subject for stereoscopic image capture, the illumination method may be controlled by a controller having one or more processors, the illumination method comprising acts of: outputting multi-spectral light by a light source; filtering, by a selected complementary multiband bandpass filter (CMBF) of a first CMBF and a second CMBF, the multi-spectral light incident thereon and outputting filtered light; illuminating the subject using the filtered light for reflection from the subject as filtered light; receiving by a camera the filtered light reflected from the subject and passing through a pupil CMBF pair and a detection lens for forming video images of the subject; capturing by the camera the video images of the subject; and generating corresponding video information and a synchronization signal, the video information including a plurality

of left and right image frame information, the synchronization signal corresponding to a start time of an act of capturing a left or a right image frame information of the plurality of left and right image frame information.

It is also envisioned that the method may include acts of selectively passing, using a digital mirror array (DMA), the multi-spectral light to a selected light path of one of first and second light paths in accordance with a time-multiplexing scheme, the first light path including the first CMBF and the second light path including the second CMBF; receiving the multi-spectral light passed by the DMA; and collimating the multi-spectral light which is to be incident on the selected first or second CMBFs of the optics portion. Further, the method may include the act of integrating the filtered light from the selected first or second CMBFs; and transmitting the filtered light along a third light path to illuminate the subject. The video information may include a plurality of left and right image frame information, and the synchronization signal corresponds to a start time of an act of capturing a left or a right image frame. Further, the method may include acts of determining a delay interval Δt in accordance with the plurality of left and right image frame information; and generating a trigger signal in accordance with the synchronization signal and the delay interval Δt for each of the left and right image frames.

It is also envisioned that the method may include an act of controlling timing of illumination to the selected one of the first or second light paths in accordance with the trigger signal.

In accordance with yet another aspect of the present system, there is disclosed a computer program stored on a computer readable memory medium, the computer program includes computer instructions, when executed by a processor, configure the processor to control a system, for illumination of a subject for stereoscopic image capture, for performing the act of: causing a light source to output multi-spectral light for filtering, by a selected complementary multiband bandpass filter (CMBF) of the first CMBF and the second CMBF, the multi-spectral light incident on the selected CMBF, for outputting filtered light, and for illuminating the subject using the filtered light; causing a camera to capture video images of the subject by receiving the filtered light reflected from the subject and passing through a pupil CMBF pair and a detection lens for forming the video images of the subject; and generating corresponding video information and a synchronization signal, the video information including a plurality of left and right image frame information, the synchronization signal corresponding to a start time of an act of capturing a left or a right image frame information of the plurality of left and right image frame information.

It is also envisioned that program portion may be configured to control the system for performing acts of causing a digital mirror array (DMA) to selectively pass the multi-spectral light to a selected light path of one of first and second light paths in accordance with a time-multiplexing scheme, the first light path including the first CMBF and the second light path including the second CMBF; receiving the multi-spectral light passed by the DMA; and/or collimating the multi-spectral light which is to be incident on the selected first or second CMBFs of the optics portion. Further, the program portion may be further configured to: integrate the filtered light from the selected first or second CMBFs; and transmit the filtered light along a third light path to illuminate the subject.

Moreover, the program portion may be further configured to: determine a delay interval Δt in accordance with the

plurality of left and right image frame information; and generate a trigger signal in accordance with the synchronization signal and the delay interval Δt for each of the left and right image frames. It is also envisioned that the program portion may be further configured to control timing of illumination to the selected one of the first or second light paths in accordance with the trigger signal.

In accordance with yet a further aspect of the present system, there is disclosed an endoscopic illumination system for illuminating a subject for stereoscopic image capture, the illumination system comprising: a processor; and a memory operatively coupled to the processor, where the processor is configured to: cause a light source to output multi-spectral light for filtering, by a selected complementary multiband bandpass filter (CMBF) of a first CMBF and a second CMBF, the multi-spectral light incident on the selected CMBF, for outputting filtered light, and for illuminating the subject using the filtered light; cause a camera to capture video images of the subject by receiving the filtered light reflected from the subject and passing through a pupil CMBF pair and a detection lens for forming the video images of the subject; and generate corresponding video information and a synchronization signal, the video information including a plurality of left and right image frame information, the synchronization signal corresponding to a start time of an act of capturing a left or a right image frame information of the plurality of left and right image frame information.

The invention is explained in further detail, and by way of example, with reference to the accompanying drawings wherein:

FIG. 1 is a schematic flow diagram of a portion of an endoscopic system (hereinafter system for the sake of clarity) according to embodiments of the present system;

FIG. 2 is a schematic flow diagram of a portion of an endoscopic system (hereinafter system for the sake of clarity) according to embodiments of the present system;

FIG. 3 is a schematic flow diagram of a portion of an endoscopic system (hereinafter system for the sake of clarity) using a filterless method according to embodiments of the present system;

FIG. 4A is a front view of the CMBF pair in accordance with embodiments of the present system;

FIG. 4B is a front view of another CMBF pair in accordance with embodiments of the present system;

FIG. 4C illustrates a CMBF pair having N CMBFs in accordance with yet another embodiment of the present system;

FIG. 4D is a spectral plot of light transmission by an ideal complementary triple-band bandpass CMBF in accordance with embodiments of the present system;

FIG. 5A is a graph illustrating synchronized output of the first and second CMBFs 110-1 and 110-2, respectively, in time in accordance with embodiments of the present system;

FIG. 5B is a graph illustrating unsynchronized output of the first and second CMBFs, respectively, in time in accordance with embodiments of the present system;

FIG. 5C is a screenshot illustrating a frame captured by the camera during unsynchronized operation;

FIG. 5D is a screenshot illustrating a frame captured by the camera during synchronized operation;

FIG. 6A is a graph of frames of the video output signal in time in accordance with embodiments of the present system;

FIG. 6B is a graph illustrating the half data rate fill technique in accordance with embodiments of the present system;

5

FIG. 6C is a graph illustrating the half data rate fill technique in accordance with embodiments of the present system;

FIG. 6D is a graph 600D illustrating the interpolation technique in accordance with embodiments of the present system;

FIG. 7 is a graph of a correction matrix in accordance with embodiments of the present system;

FIG. 8 includes graphs which illustrate an application of a Bradford Matrix in accordance with embodiments of the present system;

FIG. 9 shows a graph illustrating error reduction after Bradford correction in accordance with embodiments of the present system;

FIG. 10 shows a graph of a histogram of error of left filters without chromatic adaptation in accordance with embodiments of the present system;

FIGS. 11A-C show graphs of spectral curves for error correction in accordance with embodiments of the present system;

FIG. 12 shows graphs illustrating an error correction method in accordance with embodiments of the present system;

FIG. 13 shows a schematic flow diagram 1300 of an available image capture pipeline system that may be used to capture 3D images using the illumination systems of the present embodiments; and

FIG. 14 shows a portion of a system (e.g., peer, server, etc.) in accordance with an embodiment of the present system.

The following description of certain exemplary embodiments is merely exemplary in nature and is in no way intended to limit the invention or its applications or uses. In the following detailed description of embodiments of the present systems and methods, reference is made to the accompanying drawings which form a part hereof, and in which are shown by way of illustration specific embodiments in which the described systems and methods may be practiced. These embodiments are described in sufficient detail to enable those skilled in the art to practice the presently disclosed systems and methods, and it is to be understood that other embodiments may be utilized and that structural and logical changes may be made without departing from the spirit and scope of the present system.

The following detailed description is therefore not to be taken in a limiting sense, and the scope of the present system is defined only by the appended claims. The leading digit(s) of the reference numbers in the figures herein typically correspond to the figure number. Moreover, for the purpose of clarity, detailed descriptions of certain features will not be discussed when they would be apparent to those with skill in the art so as not to obscure the description of the present system.

Two methods using similar digital mirror array (DMA) technology will be described below. The first of these methods shown and described with reference to FIGS. 1 and 2 is a filter-based method which uses a spatial pattern generated by a DMA to selectively illuminate different parts of illumination complementary bandpass filters (CMBFs) of a CMBF pair matched to transmission of CMBF pair in the camera, also referred to as pupil CMBF pair. In particular, the illumination is identical to the pupil CMBF pair having identical complementary passbands shown in FIG. 4D, and further described in U.S. Patent Application Publication 2011/0115882 and U.S. Patent Application Publication No. 2014/0088361 filed on Sep. 27, 2012, and claiming priority to U.S. Provisional Patent Application Ser. No. 61/539,842.

6

The second method is referred to as a filterless method which uses a dispersive optical element such as a prism, grating, etc. to separate the wavelengths of an input light source spatially. Then a DMA selectively passes or rejects these separate wavelengths based on the on/off state of a mirror of the DMA.

Regardless of method used, computational methods (e.g., digital signal processing (DSP)), etc., may be performed on generated signal information (e.g., video out, and sync as will be discussed below) using any suitable mathematical modeling methods and/or numerical analysis methods such as may be provided by Matlab™. For example, DSP may be performed using standard Matlab™ DSP libraries, etc.

1. Filter Based Methods

A schematic flow diagram of a portion of an endoscopic system 100 (hereinafter system for the sake of clarity) according to embodiments of the present system is shown in FIG. 1. The system 100 includes one or more of an illumination portion 101, a CMBF pair 110, an integrator 112, a light guide 114, an image capture device such as a camera 125, a processing portion 118, a controller 122, a memory 130, and a user interface (UI) 120.

The CMBF pair 110 is also referred to an illumination CMBF pair (i.e., right and left CMBFs 110-1, 110-2) which is matched or identical to a pupil CMBF pair 110-3, 110-4 that receives light provided through the illumination CMBF pair and reflected from the subject or object of interest 116 for selective sequential passage by the pupil CMBF pair of right and left images toward detector optics and a detector or camera 125 having a single focal plane array (e.g., CMOS or CCD) for obtaining stereoscopic 3-D images, where the detector optics including the pupil CMBF pair and the detector or camera 125 are included in a small housing, such as a cylindrical housing having a diameter of 3 mm-5 mm. The detector optics comprises a detection lens system that includes a detection lens 113 having one un-partitioned section that covers both the right pupil CMBF 110-3 and a left pupil CMBF 110-4, for directing and/or focusing light passing through the pupil CMBFs 110-3, 110-4 onto the camera 125, such as described in US 2011/0115882, and US 2014/0088361, which claims priority to U.S. Provisional Patent Application Ser. No. 61/539,842. For example, the detection lens system includes optical lenses and elements that are serially connected back to back sharing a central axis and having a same diameter, such as slightly less than 4 mm, so as to fit within a 4 mm outer housing of an image capture device including the camera 125 and the detection lens system. The outer diameter of the housing may be in the range of 2-4 mm, for example. Further, for example, both the illumination CMBF pair 110-1, 110-2 and the pupil CMBF pair 110-3, 110-4 have 3 right passbands 501-1 and 3 left passbands 501-2, as shown in FIG. 4D.

The controller 122 may control the overall operation of the system 100 and may include one or more processors such as microprocessors and/or other logic devices which may be locally or remotely situated relative to each other. Further, the controller 122 may communicate via a network such as the network 132 which may include, for example, a local area network (LAN), a wide area network (WAN), a system bus, the Internet, an intranet, a proprietary network, a wireless network, a telephonic network (e.g., 3G, 4G, etc.), etc. and may send and/or receive information from, for example, distributed portions of the system such as processors, storage locations, user interfaces (UIs), etc.

The CMBF pair 110 includes first and second CMBFs 110-1 and 110-2 (generally 110-x), respectively, as will be discussed below.

The UI **120** may include a display **121** which may render information such as image information received from the processing portion **118**. Additionally, the display **121** may render other information such as applications, content, menus, time, operating parameters, etc., as may be typical of a medical imaging system, for the convenience of the user. Further, the UI **120** may include user input devices such as a joystick **123**, a keyboard KB, a mouse, etc., for input of commands and/or other information by a user.

The illumination portion **101** may include one or more of a light source **102**, a DMA **104**, and an optical portion **106**. For example, the illumination portion **101** may include a Texas Instruments™ LightCommander™ lightsource including a light emitting diode (LED) type lamps. However, the embodiments of the present system are also compatible with other light sources such as xenon lamps that provide white light and are used in the medical community.

Generally, the illumination portion **101** illuminates selected CMBF **110-x** (i.e., either the right CMBF **110-1** or the left CMBF **110-2**, one at a time, or sequentially) of the CMBF pair with multi-spectral light using a time multiplexing scheme as will be discussed below. Further, the illumination output and/or spectrum may be controlled. In the present system, the CMBFs **110-1** and **110-2** of the CMBF pair are situated side by side on a substrate as will be discussed below with reference to FIG. 4A. Thus, the illumination portion **101** may selectively select an area to illuminate of a plurality of areas as will be discussed below. The selected area will include only a single CMBF **110-1** and **110-2** of the CMBF pair **110**.

The light source **102** may, for example, include a broadband light source such as a xenon light source which may output multi-spectral light such as broadband light. However, in yet other embodiments, the light source **102** include a plurality of light emitting diodes (LED) such as red, green and blue LEDs, the combination of which may output multi-spectral light such as white light. However, in yet other embodiments, it is envisioned that other light sources may be used. However, regardless of light source type, a lighting spectrum output by the light sources should correspond with or include passbands (such as shown in FIG. 4D) of the CMBFs **110-1** and **110-2** of the CMBF pair **110**. For example, if the CMBF pair **110** only passes red, green, and blue spectrums, then the light source should at least supply illumination in these spectrums. However, in yet other embodiments, it is envisioned that the light source may supply other spectrums. The light source **102** may include one or more lenses to focus (and/or otherwise control light) emitted light which is received by the DMA **104**.

The DMA **104** is configured to selectively pass the light received from the illumination portion **101** to selected CMBFs **110-1** or **110-2** of the CMBF pair **110** in the present embodiment using a time multiplexing scheme under the control of the controller **122**. The timing of the DMA **104** may be controlled using, for example, a trigger signal Trig. Accordingly, after receiving the trigger signal Trig, the DMA **104** may be operative to transfer light from the illumination portion **101** to the selected CMBF **110-1** or **110-2**. The trigger signal Trig may be generated in accordance with one or more a feedback signals such as a Vsync and a video signal video out which may be processed to determine timing of the trigger signal Trig. As the trigger signal Trig may be constantly transmitted for each captured video frame in real time, it may include a pulse train whose timing may be controlled by the system, such as the controller **122**. As each of the CMBFs **110-1** and **110-2** may be situated in corresponding light path **111-1** and **111-2**, respec-

tively, of a plurality of light paths **111-x**, the DMA **104** may selectively pass the light received from the illumination portion **101** to selected light path **111-1** or **111-2** of a plurality of the light paths **111-x** (via, for example, an optics portion **106**) in accordance with a time-multiplexing scheme. Once light is passed to the selected light path **111-x**, it will be incident upon and filtered by the corresponding CMBF **110-x**. Thus, light selectively directed by the DMA **104** to the first light path **111-1** will substantially only be incident upon the first CMBF **110-1** of the plurality of CMBFs **110-x**. Likewise, in a next time frame, light selectively directed by the DMA **104** to the second light path **111-2** will substantially only be incident upon the second CMBF **110-2** of the plurality of CMBFs **110-x**.

The optical portion **106** may include one or more lenses and may be configured to direct, e.g., collimate and/or focus, light received from the DMA **104** and which is to be incident upon the selected CMBF **110-1** or **110-2**. Accordingly, the optical portion **106** may include one or more lenses or lens arrays such as a first lens array **124** and a second lens array **126**. The first lens array **124** may collimate light received from the DMA **104** and the second lens array **126** may direct and/or focus the collimated light to the selected light paths **111-x** and be incident upon the corresponding CMBF **110-x**, one at a time or sequentially. Accordingly, the DMA is reimaged via the one or more lenses onto the CMBF and thus allows color toggling of the Left/Right CMBFs **110-1** or **110-2**.

For example, a right light provided by the light source and DMA passes through the right illumination CMBF **110-1** to illuminate the object or volume of interest, reflect therefrom towards capture optics passing through a right pupil CMBF **110-3** for focus on an entire focal plane array of a detector to form a right image. Next, a left light provided by the light source and DMA passes through the left illumination CMBF **110-2** to illuminate the object or volume of interest, reflect therefrom towards capture optics passing through a left pupil CMBF **110-4** for focus on an entire focal plane array of a detector to form a left image. The right and left images are then processed to form a 3-D stereoscopic image of the volume of interest that provides depth information and perception, for display on a rendering device such as the display **121** or any other display, such as a heads-up display, etc.

In some embodiments, the first and second lens arrays **124** and **126**, respectively, may be commercially available digital single lens reflex (DSLR) type lenses such as Nikon™ AF Nikkor 50 mm f/1.8D lenses which are configured such that the object side (e.g., lens filter side) of the lenses are adjacent to each other. Further, the optical portion **106** may be operative to collimate light which is to be incident upon the either of the CMBFs **110-x** such that it has a normal angle of incidence (NAOI) which is less than a threshold value (e.g., at most 23-25 degrees). However, other threshold values are also envisioned.

Each of the light paths **111-x** may include one or more optical elements such as a corresponding CMBF **110-x**. With regard to the CMBFs **110-x**, each CMBF **110-x** may be configured to transmit as much RGB-spectral information as possible for rendering a color image suitable for an intended use. Accordingly, each of the CMBFs **110-x** should have the greatest number of passbands as possible, where only 3 are shown in FIG. 4D for simplicity.

However, the staggered passbands provides for each viewpoint to skip some regions in the RGB band. As a result, the two viewpoints take different spectral images thus render two different color images relative to each other. The raw

color image from each viewpoint includes red and blue color tones. However, a difference in the color tone from each viewpoint is a product of light filtering by the corresponding CMBF 110-x. This difference in color tone may be narrowed by including as many complementary passbands in each CMBF of a CMBF pair. Additionally, the difference in color tone may be narrowed further by applying a Chromatic Adaptation Transform (CAT) to provide color correction.

The colors imaged through the CMBFs may appear different from the objective colors. Two methods may be used to correct the colors. One method is using the CAT. For example, while human vision can perceive a white color as white under any light condition including incandescent or sunlight, a camera images the white color differently under different light condition. For example, under yellow light condition, a camera images the white color as yellow. But, CAT is applied to change the yellow light to white if the spectrum of the yellow light is known. CAT method may be used for color correction in the present camera imaging under CMBF filtered light conditions.

Additionally or alternately, colors can be corrected to appear close to the objective colors by digital imaging processing operations (DIP) performed by the image processing portion 118, e.g., by finding a transformation matrix, which transforms wrongly placed color coordinates to correct coordinates in a color space. To find the transformation matrix, DIP assigns coordinates to the CMBF-filtered and unfiltered colors and put them in matrices. Then, DIP equates the two and inverses the CMBF matrix and multiplies the CMBF matrix on both the side. This process yields a transformation matrix. Next, the transformation matrix applies to the colors imaged through the CMBFs to correct the colors.

Each CMBF 110-x of the CMBF pair 110 may be separate from each other or formed integrally with each other. For example, in some embodiments, the CMBFs 110-x may be formed on a common substrate using, for example, a stereolithography technique so as to form an integrated CMBF pair 110. However, in yet other embodiments, the CMBFs 110-x may be separate from each other and located adjacent to each other or located separately from each other. Thus, a CMBF pair may be distributed. In yet other embodiments, the CMBFs 110-x may be adjacent to each other, and attached to a common element, such as formed on a lens by coating is with up to 100 layers of material to form an interference type filter with sharp edges. This is illustrated with reference to FIG. 4A which is a front view of the CMBF pair 110 in accordance with embodiments of the present system. The first and second CMBFs 110-1 and 110-2 are adjacent to each other and exclusively occupy corresponding areas on the CMBF pair 110. The shape and size of these areas may include, for example, half-circles as shown. In yet other embodiments, other shapes and/or sizes of these areas is also envisioned.

FIG. 4B is a front view of another CMBF pair 410B in accordance with embodiments of the present system. The CMBF pair 410B is similar to the CMBF pair 110 and includes first and second CMBFs 410B-1 and 410B-2 which may be correspondingly similar to the first and second CMBFs 410-1 and 410-2, respectively, in operation. However, unlike the first and second CMBFs 410-1 and 410-2, respectively, the first and second CMBFs 410B-1 and 410B-2, respectively, have a circular shape, where the two circle by touch or be separated from each other by any desired distance.

In yet other embodiments further numbers of CMBFs may be formed on a single substrate. For example, FIG. 4C

illustrates a CMBF pair 410C having N CMBFs in accordance with yet another embodiment of the present system. Where, N is an integer greater than 2. The CMBF pair 410C includes N CMBFs 410C-1 through 410C-N each of which occupies an exclusive area and has complementary passbands.

FIG. 4D is a spectral plot 400D of light transmission by an ideal complementary triple-band bandpass CMBF in accordance with embodiments of the present system. The CMBF may include two CMBF filters such as first and second CMBF filters 410C-1 and 410C-2, respectively, which are respectively similar to the first and second CMBF filters 110-1 and 110-2, respectively, of the CMBF pair 110. Light bands passed are exclusive to each filter (e.g., 510-1 and 510-2) of a plurality of filters.

Referring back to FIG. 1, filtered light from the first and/or second CMBFs 110-1 and 110-2, respectively, is then transmitted sequentially or one at a time to the integrator 112 for transmission through to a subject 116 (e.g., an volume of interest (VOI), etc. as may be typical for an endoscopic use, etc.) via, for example, a light guide 114. Light from only one of the first or second CMBFs 110-1 and 110-2, respectively, at a time is transmitted in a time-multiplexed manner. Thereafter, the camera 125 may capture images of the subject and transmit a corresponding image stream as a video output signal (e.g., including a plurality of frames each including image information) to the image processing portion 118 as video information for further processing. Further, the camera 125 may generate and transmit an output pulse such as a synchronization signal VSYNC which signals a beginning of a frame capture by the camera 125. As the frame capture is continuously preformed in time, the synchronization signal Vsync comprises a signal pulse train with each pulse corresponding with the beginning of a frame capture. The camera may include a buffer memory to store video output signals before transmission. The camera may include optics as well as the pupil CMBF pair 110-3, 110-4 which is identical to the illumination CMBF pair 110-1 and 110-2, as described in U.S. Patent Application Publication No. 2011/0115882 and U.S. Patent Application Publication No. 2014/0088361, claiming priority to U.S. Provisional Patent Application Ser. No. 61/539,842.

The image processing portion 118 may receive the Vsync signal and/or video information from the camera 125 for further processing. For example, the image processing portion 118 may include one or more processors or other logic devices which may process the video information (e.g., video out) from the camera 125 (e.g., using any suitable image processing technique and/or applications which may, for example, use digital signal processing (DSP) methods, etc.), and thereafter form corresponding image information. This image information may then be rendered on a UI of the system such as the UI 120, and/or the image information stored in a memory of the system such as the memory 130. The system may employ commercially available signal processing methods to process the image information using, for example, Matlab™ signal processing libraries or the like. Then, the image information may be analyzed to determine proper signal timing (e.g., a correct signal delay time Δt). However, other methods to determine signal timing are also envisioned.

Further, the image processing portion 118 may determine a correct signal delay time Δt and output a trigger signal Vsync+ Δt . The trigger signal Vsync+ Δt may then be transmitted to one or more of the controller 122, the source, and/or the DMA 104 and may be used by the DMA 104 to correctly time illumination of the selected CMBF 110-x. The

11

timing of exposure of the CMBFs **110-x** is more clearly illustrated with reference to FIG. **5A** which is a graph **500A** illustrating synchronized output of the first and second CMBFs **110-1** and **110-2**, respectively, in time in accordance with embodiments of the present system. The first and second CMBFs **110-1** and **110-2**, respectively, mutually output illumination in the time domain as shown. The camera's **125** exposure is synchronized to the illumination of the CMBFs **110-x** by the DMA **104** as shown. The camera **125** may then capture a plurality of frames (e.g., image frames) such as frames left **1** (L1), right **1** (R1), L2, R2, . . . where the right frame refers to frames corresponding to image information of the subject **116** which were illuminated by or through the first CMBF-1, and where the left frame refers to frames corresponding to image information of the subject **116** which were illuminated by or through the second CMBF-2. The camera **125** may embed information into the frames as frame data. The frame data may include a sequence number (e.g., odd frames are left frames and even frames are right frames as identified by the system), a time stamp (the time information may identify whether a frame is a right or a left frame and a position in time of the frame relative to other frames).

FIG. **5B** is a graph **500B** illustrating unsynchronized output of the first and second CMBFs **110-1** and **110-2**, respectively, in time in accordance with embodiments of the present system. The camera's **125** exposure is not synchronized to the illumination of the CMBFs **110-x** by the DMA **104** as shown. The system may employ image recognition techniques to analyze video information video out from the camera **125** (e.g., using any suitable image processing technique and/or applications which may, for example, use digital signal processing (DSP) methods, etc.), and thereafter form corresponding time delay information (e.g., increase or decrease time delay), to correct timing and form proper images similar to the images of the synchronized system.

FIG. **5C** is a screenshot **500C** illustrating a frame captured by the camera **125** during unsynchronized operation, such as before any delay adjustment, and includes distortions at the top of the figure shown by arrows which include undesired rows that captured from previous illumination conditions. FIG. **5D** is a screenshot **500D** illustrating a frame captured by the camera **125** during synchronized operation, such as corrected by a proper delay, for example, determined by image recognition of images in different frames and alignment of the images for synchronization. In FIG. **5D**, only illumination from a desired time period is captured, thus eliminating the undesired distortion shown by arrows in FIG. **5C**.

Although feedback-based synchronization methods are described, in yet other embodiments the system may synchronize without using a feedback based signal. For example, the DMA **104** may transmit a signal (e.g., a pattern, a color, etc.) which the camera may use to synchronize with the DMA **104**.

Referring back to FIG. **1**, in accordance with embodiments, of the present system, the image processing portion **118** may include first and second processing portions PP1 (readout) and PP2 (trigger), respectively. Each of these processing portions PP1 and PP2 may have microcontroller such as an Arduino™ microcontroller with a high-precision clock and operate in accordance with operating instructions of embodiments of the present system so as to perform operations in accordance with routines and/or methods of embodiments of the present system. The second processing portion PP2 may be referred to as a trigger portion (as it

12

generates and transmits the trigger signal (e.g., $V_{sync} + \Delta t$) and may receive the V_{sync} signal and/or the timing information from the camera **125**. The first processing portion (PP1) may process captured image (e.g., see, FIGS. **5A** and **5B**), and results of the processing may then be used to control delay of the trigger signal. As the V_{sync} signal is generated after exposure (e.g., by the camera for a captured image frame) has started, a signal delay time Δt may be determined and added to the V_{sync} so as to properly control timing of the trigger signal.

Once the DMA **104** and the camera **125** are synchronized, the illumination and image capture may be considered to be synchronized.

A schematic flow diagram of a portion of an endoscopic system **200** (hereinafter system for the sake of clarity) according to embodiments of the present system is shown in FIG. **2**. The system **200** is essentially similar to the system **100** shown in FIG. **2**. However, rather than using the source **101** having a lens array **126**, an integrated source **201** is coupled to a lens array **226**. The source **226** includes a commercially available light projector (e.g., a DLP projector) such as available from DLP™ LightCommander™ from Texas Instruments, and is coupled to the lens array **226** which is similar to the lens array **126**. As the combination of the source **201** and the lens array **226** includes similar inputs (e.g., trigger and control) and operates similarly to the source **101**, a further discussion thereof will not be provided for the sake of brevity. The light projector may receive a control signal (control) from the controller and/or video processor) and may control an output spectrum and/or intensity accordingly. The control signal may be generated in accordance with feedback information obtained from one or more sensors and/or from analysis of the video output of the camera **125**.

2. Filterless Methods

A schematic flow diagram of a portion of an endoscopic system **300** (hereinafter system for the sake of clarity) using a filterless method according to embodiments of the present system is shown in FIG. **3**. The system **300** includes one or more of an illumination portion including a light source **102**, a first optics portion **304**, a dispersive optics **306**, a second optics portion **308**, a DMA **310**, an integrator **112** also referred to as a integrating rod or a homogenizing rod, and a light guide **114**. The source **102** may output multi-spectral light such as broadband light which is input to the first optics portion **304** which collimates, focuses and directs the broadband light upon a prism **307** of the dispersive optics **306**. The system **300** may be similar to the system **100** accordingly, similar numerals have been used to describe the same or similar portions and detailed descriptions of these portions will not be given for the sake of clarity. However unlike the system **100**, the system **300** does not employ the use of filters, such as the CMBFs of system **100**. Rather, the system **300** employs the user of the dispersive optics **306** (e.g., a dispersive optical element) such as a prism **307**, grating, etc., to separate the wavelengths of input light (e.g., the broadband light) spatially to form spatially separated illumination. The spatially separated illumination (e.g., having a spread illumination spectrum as shown at **319**) is then focused by the second optics portion **308** which images the spatially-dispersed illumination upon the DMA **310**. Then, the DMA **310**, under the control of the controller **122**, selectively passes a desired spectrum of light (of a plurality of spectrums) from the spatially separated illumination to integrator **112** for transmission to, and illumination of, the subject **116**. The integrating rod **112** uses total internal reflection to homogenize any non-uniform light.

As methods used to capture video images of the subject **116**, image processing (e.g., DSP), timing, etc., may be performed similarly to the methods used with respect to the description of the systems shown and described with respect to FIGS. **1** and **2**. Illustratively, the DMA may be configured to operate for hyperspectral imaging and/or CMBF Stereo-imaging. For example, taking the ROYGBIV of the diagram as a starting point, assume the DMA has 7 rows which pass light as follows: Row 1 passes R; Row 2 passes O; Row 3 passes Y; Row 4 passes G; Row 5 passes B; Row 6 passes I; and Row 7 passes V. For hyperspectral imaging: turn rows on sequentially to measure a 7-color (ROYGBIV) image of the scene instead of traditional 3 color (RGB). This can be extended to an N-color image where N is the number of addressable rows of the DMA. For CMBF Stereo-imaging: further CMBF filters **110-3** and **110-4** are used, also referred to as pupil CMBs filters **110-3**, **110-4**. Assuming the first or right CMBF **110-3** passes (R Y B V) and the second or left CMBF **110-4** passes (O G I), then a time series would be alternating frames of (1, 3, 5, 7) and (2, 4, 6).

Image Reconstruction

Referring back to FIG. **1**, an image processor such as a video graphics processor (e.g., the PP1) may process frames of the video output signal from the camera **125** and reconstruct corresponding stereoscopic images captured by the camera **125**. In accordance with a first method, the video output signal containing the left and right frames may be demultiplexed and thereafter rendered on the display **121**. Accordingly, the image processor may obtain frame information identifying a frame, such as a sequence number a time stamp, etc., for each frame of a plurality of frames from the video output information. Thereafter, the image processor may interleave right and left frames together. This process is shown in FIG. **6A** which is a graph **600A** of frames **602** of the video output signal in time in accordance with embodiments of the present system. The right (Rx) and left (Lx) frames from the video output signal output by the camera **125** are shown in the top row **604** and may be referred to as an input data stream. The video processor then separates these frames into a right data stream **606** and a left data stream **608** each having a plurality of right or left frames, respectively. With reference to frames L1, L2, and L3 in the left data stream **608**, spaces between these frames may be referred to as empty spaces (\emptyset) and may be filled in by the image processor. The image processor may now fill in empty spaces between adjacent frames (e.g., L1 and L2, L2 and L3, . . . ; R1 and R2, R2 and R3, . . .) using one or more filling techniques in accordance with embodiments of the present system. These fill techniques may include, for example: (a) a half data rate fill technique; (b) a double write frame technique; and (c) an interpolation technique. These techniques will be explained with reference to FIGS. **6B-6D**. In each of these figures, the input data stream is assumed to be the same.

With regard to the half data rate fill technique, a data rate of the video output stream is halved by the image processor thus, for example, if the video output is a 1080p60 data stream, the image processor would convert this data stream to a 1080p30 data stream, and thus, effectively fill in the empty spaces in the left and right data streams. FIG. **6B** is a graph **600B** illustrating the half data rate fill technique in accordance with embodiments of the present system.

With regard to the double write frame fill technique, in this technique each frame of the input data stream is repeated to fill an adjacent empty space. For example, each right and left frame is repeated so as to fill in the empty spaces in the left and right data streams (c.f. FIGS. **6A** and **6C**). This is

better illustrated with reference to FIG. **6C** which is a graph **600C** illustrating the double data rate fill technique in accordance with embodiments of the present system.

With regard to the interpolation technique, in this technique adjacent frames of each frame of the corresponding right or left input data stream are used to interpolate and fill empty space between these adjacent frames in the corresponding right or left data stream. This is better illustrated with reference to FIG. **6D**, which is a graph **600D** illustrating the interpolation technique in accordance with embodiments of the present system.

Illumination Control

Referring once again to FIG. **1**, the camera may capture video images of the subject **116** (e.g., an object of interest) which is illuminated in accordance with embodiments of the present system. The illumination of the subject **116** may be controlled so as to properly illuminate the subject **116**. Accordingly, the video information may be tagged with illumination spectrum information that is used to correct the raw image data. For example, a measured value of a light sensor output is monitored and, if the illumination is determined to be less than a threshold illumination value, the process may control the source **102** to increase illumination output. Conversely, if the illumination is determined to be greater than the threshold illumination value, the process may control the source **102** to decrease illumination output. Lastly, if the illumination is determined to be equal to (or substantially equal to) the threshold illumination value, the process may control the source **102** to hold the current the illumination output. For example, a measured value of a light sensor output is monitored. If the average value is below a first predetermined value (e.g., 10% of full scale), the output of the light source is increased. If the average value is above a second predetermined value (e.g., 90% of full scale), then the output of the light source is decreased. This is to avoid underexposure and overexposure in photography terms.

The tagging of the video information with illumination information may be performed by the first processing portion PP1 that may read a current state of the illumination of the received video information. Two processing portions are used to avoid switching instability which may be caused by latency of a computer-processing board connection(s). Accordingly, the first processing portion PP1 may operate at a slow switching speed, such as 25 MHz, while the second processing portion PP2 may operate at a native clock speed, such as 16 MHz. However, in yet other embodiments, a single processor may be employed.

However, in yet other embodiments, an image processor such as an Nvidia™ Quadro™ SDI, or a field-programmable gate array (FPGA) may process the video information and form corresponding image information and/or determine timing of the system.

Color Control

In accordance with embodiments of the present system, the image processor may apply a standard or user defined color space conversion matrix to the video output stream, or may load an identity matrix and leave the color space unaltered, such as using a Chromatic Adaptation Transform (CAT), and/or digital imaging processing operations (DIP) to find a transformation matrix, to provide color correction as described above. A processor of the image processing portion **118** may carry out DIP operations to find the transformation matrix, such as by assigning coordinates to the CMBF-filtered and unfiltered colors and putting them in matrices. Then, DIP equates the two and inverses the CMBF matrix and multiplies the CMBF matrix on both the side.

Image Processing

The digital image processing operations (DIP) include manipulating images to gain any kind of useful information. Digital image processing may include operations that assign coordinates to individual elements in an image so that mathematics can be applied to extract useful information. For example, DIP can count many beans in the image, can detect a certain shape, or can calculate a speed of a moving object, etc.

In yet other embodiments of the present system, there is disclosed a design tool which simulates the all parts of the optical system and may determine characteristics of illumination sources (e.g., output spectrum, lumens, etc.) and/or CMBF filters (e.g. passbands, layers, etc.). The design tool may include a process which starts by using measured or simulated illumination spectrum from a light source. This spectrum is then passed through a hypothetical filter transmission spectrum. The resultant light is then used to calculate what a standard color checker chart (Munsell) would look like under the hypothetical illumination. This is then passed through the measured camera imager spectral response to determine the RAW values of the image. Then a color correction algorithm is employ to map the measured values as closely to the true values of the color checker chart. Finally, standard International Commission on Illumination (CIE) color accuracy metrics are computed to determine the error in 'Lab' or 'Luv' color space to determine the overall performance of the system, where 'L' is the lightness dimension and 'a', 'b', 'u', 'v' are color component dimensions. While there are other color spaces, the unique characteristic about Lab color space is that the space is flat, "perceptually uniform." Perceptually uniform means that a change of the same amount in a color value should produce a change of about the same visual importance. In this space, the color difference between two colors is simply a geodesic difference between two points in the color space, $\sqrt{x^2+y^2+z^2}$ or $\sqrt{L^2+a^2+b^2}$, where 'sqrt' is a square root operation.

These error values are computed for all colors on the chart, and the results from these simulations are compared afterwards. These values can be used to find the filter transmission that has the best overall performance. This data is used in specify the filter transmission to vendors. When vendors return their best estimate of their filter transmission, then it is verified that the performance has not been significantly degraded before moving forward on custom filter fabrication. Additionally, under fixed optical conditions, the relative performance of different color correction techniques is evaluated and the algorithm is selected that has the best performance within the system constraints of computing power and sensor noise.

Image Exposure Timing

When a frame (e.g., see, L1, L2, R1, R2, . . . etc.) is captured, it is read row-by-row with a gap in exposure times (between each row) given by Δt_{row} as defined in equation 1 below:

$$\Delta t_{row} = t_{frame} / N_{rows} = 1/30 \text{ sec} / 400 = 83.3 \text{ } \mu\text{sec} \tag{Eq. 1}$$

where t_{frame} is an exposure time for a corresponding frame (1/30 sec in the present example) and N_{rows} is a number of rows in the frame (400 in the present example, although other number of rows such as 1080 rows are also envisioned). Accordingly, if each row has an exposure time t_{exp} , a timing diagram for frames having N rows would look like that shown in Table 1 below.

TABLE 1

Row	Start Time	End Time
0	0	t_{exp}
1	t_{row}	$t_{exp} + t_{row}$
2	$2t_{row}$	$t_{exp} + 2t_{row}$
...
N	Nt_{row}	$t_{exp} + Nt_{row}$

If flat illumination is assumed, i.e., the magnitude of illumination is constant in time, even if the system is switched from one illumination condition to another arbitrarily fast (e.g., by the DMA), some of the rows of a previous frame may be exposed during the readout of the first rows of the current frame. The rows may receive undesirable light for times $\{t_{row}, 2t_{row}, \dots, t_{row}((N)-1)\}$. This may manifest itself as crosstalk, where part of a left image frame appears in the right image frame or vice versa (e.g., see, FIG. 5B). Even when perfectly synchronized, there may be a limit on the crosstalk C, imposed by the exposure time given by:

$$C = (\text{undesirable illumination}) / (\text{total illumination})$$

$$= ((1/2) * t_{row} (t_{exp} / t_{row}) ((t_{exp} / t_{row}) - 1)) / (t_{exp} * N_{rows})$$

$$= ((t_{exp} / t_{row}) - 1) / (2 * N_{rows})$$

Embodiments of the present system may run in the limit on no crosstalk ($t_{exp}=t_{row}$) with sufficient illumination and may depend on the losses in the optical systems and sensitivity of an imager used. The necessary exposure time may also depend on external factors, such as the allowable light flux to a patient to avoid undesirable heating and the field of view of an imaging system used.

Flat Illumination, Realistic Switching

In practice, the switching speed between different illumination conditions cannot be ignored and may be reduced (e.g., minimized) by using a Digital Micromirror Array (DMA) (also referred to as a Digital Micromirror Device (DMD)). In a DMA/DMD module of embodiments of the present system (e.g., a DLP LightCommander™, Logic PD) a maximum refresh rate is 5000 Hz, or $t_{refresh}=200 \mu\text{s}$. However, there is no need to rapidly switch back and forth between illumination conditions since lighting paths (e.g., path 1 CMBF-1 and light path 2 CMBF-2) are only being changed once per frame. Accordingly, a more relevant figure of merit in this case is an actual ON-OFF transition time for a DMA, which is on order 5 μs , or as a fraction of the row time, $t_{ON-OFF} / t_{row}=6\%$. This implies that we can switch within a single row read time if the DMA is sufficiently synchronized with the imager (assuming, for example, the system is only limited by the jitter in the timing signal or other delays in the electronics). Additionally, even at full sensitivity, there will be Poisson noise from the photons. Given the sensor sensitivity, a full well may be estimated to be approximately 1000 e-, which implies a noise of $1/\sqrt{1000}=3.16\%$. Thus, the system may be within a factor of two of this intrinsic noise floor.

FIG. 7 shows a graph of a correction matrix in accordance with embodiments of the present system. Raw information from the video out signal may be processed using any suitable processing methods such as a Bradford transformation.

FIG. 8 shows graphs 800A through 800D illustrating an application of a Bradford Matrix in accordance with

embodiments of the present system. For example, the Bradford Matrix is used to determine a theoretical correction, where predicted measures values are generated based on the illumination condition, and the difference from a reference color checker chart is computed.

FIG. 9 shows a graph 900 illustrating error reduction after Bradford correction in accordance with embodiments of the present system.

FIG. 10 shows a graph 1000 of a histogram of error of left filters without chromatic adaptation in accordance with embodiments of the present system.

FIGS. 11A-C shows graphs 1100A through 1100C of spectral curves for error correction in accordance with embodiments of the present system.

FIG. 12 shows graphs 1200A through 1200E illustrating an error correction method in accordance with embodiments of the present system. Results are shown in Table 1200F.

FIG. 13 shows a schematic flow diagram 1300 of an image capture pipeline system available from Nvidia™ that may be used to capture 3D images for use along with the illumination systems in accordance with the present embodiments.

FIG. 14 shows a portion of a system 1400 (e.g., peer, server, etc.) in accordance with an embodiment of the present system. For example, a portion of the present system may include a processor 1410 operationally coupled to a memory 1420, a display 1430, RF transducers 1460, a camera/sensors 1490, and a user input device 1470. The memory 1420 may be any type of device for storing application data as well as other data related to the described operation. The application data and other data are received by the processor 1410 for configuring (e.g., programming) the processor 1410 to perform operation acts in accordance with the present system. The processor 1410 so configured becomes a special purpose machine or processor particularly suited for performing in accordance with embodiments of the present system.

The operation acts may include configuring an endoscopic imaging system by, for example, controlling one or more of a position of an imaging portion, the camera/sensors 1490, and/or the actuators 1460. The camera/sensors may provide information to the processor 1410 such as image information (in 2D or 3D), temperature information, position information, etc. The actuators 1460 may be controlled to position the camera in a desired orientation, turn the camera on/off, and/or to provide illumination to a volume of interest (VOI) so that the camera may capture images. The processor 1410 may receive the image information from the camera, and may render the image information on, for example, a user interface (UI) of the present system such as on the display 1430. Further, the processor 1410 may store the image information in a memory of the system such as the memory 1420 for later use.

The user input 1470 may include a joystick, a keyboard, a mouse, a trackball, or other device, such as a touch-sensitive display, which may be stand alone or be a part of a system, such as part of a personal computer, a personal digital assistant (PDA), a mobile phone, a monitor, a smart or dumb terminal or other device for communicating with the processor 1410 via any operable link. The user input device 1470 may be operable for interacting with the processor 1410 including enabling interaction within a UI as described herein. Clearly the processor 1410, the memory 1420, display 1430, and/or user input device 1470 may all or partly be a portion of a computer system or other device such as a client and/or server.

The methods of the present system are particularly suited to be carried out by a computer software program, such program containing modules corresponding to one or more of the individual steps or acts described and/or envisioned by the present system. Such program may of course be embodied in a computer-readable medium, such as an integrated chip, a peripheral device or memory, such as the memory 1420 or other memory coupled to the processor 1410.

The program and/or program portions contained in the memory 1420 configure the processor 1410 to implement the methods, operational acts, and functions disclosed herein. The memories may be distributed, for example between the clients and/or servers, or local, and the processor 1410, where additional processors may be provided, may also be distributed or may be singular. The memories may be implemented as electrical, magnetic or optical memory, or any combination of these or other types of storage devices. Moreover, the term “memory” should be construed broadly enough to encompass any information able to be read from or written to an address in an addressable space accessible by the processor 1410. With this definition, information accessible through a network is still within the memory, for instance, because the processor 1410 may retrieve the information from the network for operation in accordance with the present system.

The processor 1410 is operable for providing control signals and/or performing operations in response to input signals from the user input device 1470 as well as in response to other devices of a network and executing instructions stored in the memory 1420. The processor 1410 may be an application-specific or general-use integrated circuit(s). Further, the processor 1410 may be a dedicated processor for performing in accordance with the present system or may be a general-purpose processor wherein only one of many functions operates for performing in accordance with the present system. The processor 1410 may operate utilizing a program portion, multiple program segments, or may be a hardware device utilizing a dedicated or multi-purpose integrated circuit. While the present system has been described with a reference to a gesture input system for manipulating a computer environment, it is also envisioned that user interaction with and/or manipulation of the computer environment may also be achieved using other devices such as a mouse, a trackball, a keyboard, a touch-sensitive display, a pointing device (e.g., a pen), a haptic device, etc.

Further variations of the present system would readily occur to a person of ordinary skill in the art and are encompassed by the following claims. Through operation of the present system, a virtual environment solicitation is provided to a user to enable simple immersion into a virtual environment and its objects.

Finally, the above-discussion is intended to be merely illustrative of the present system and should not be construed as limiting the appended claims to any particular embodiment or group of embodiments. Thus, while the present system has been described with reference to exemplary embodiments, it should also be appreciated that numerous modifications and alternative embodiments may be devised by those having ordinary skill in the art without departing from the broader and intended spirit and scope of the present system as set forth in the claims that follow. In addition, the section headings included herein are intended to facilitate a review but are not intended to limit the scope of the present system. Accordingly, the specification and

drawings are to be regarded in an illustrative manner and are not intended to limit the scope of the appended claims.

The section headings included herein are intended to facilitate a review but are not intended to limit the scope of the present system. Accordingly, the specification and drawings are to be regarded in an illustrative manner and are not intended to limit the scope of the appended claims.

In interpreting the appended claims, it should be understood that:

- a) the word “comprising” does not exclude the presence of other elements or acts than those listed in a given claim;
- b) the word “a” or “an” preceding an element does not exclude the presence of a plurality of such elements;
- c) any reference signs in the claims do not limit their scope;
- d) several “means” may be represented by the same item or hardware or software implemented structure or function;
- e) any of the disclosed elements may be comprised of hardware portions (e.g., including discrete and integrated electronic circuitry), software portions (e.g., computer programming), and any combination thereof;
- f) hardware portions may be comprised of one or both of analog and digital portions;
- g) any of the disclosed devices or portions thereof may be combined together or separated into further portions unless specifically stated otherwise;
- h) no specific sequence of acts or steps is intended to be required unless specifically indicated; and
- i) the term “plurality of” an element includes two or more of the claimed element, and does not imply any particular range of number of elements; that is, a plurality of elements may be as few as two elements, and may include an immeasurable number of elements.

What is claimed is:

1. An endoscopic illumination system for illuminating a subject for stereoscopic image capture, the illumination system comprising:

a light source which outputs multi-spectral light; first and second light paths configured to transmit the multi-spectral light;

a first complementary multiband bandpass filter (CMBF) and a second CMBF, the first CMBF being situated in the first light path and the second CMBF being situated in the second light path, wherein the first CMBF and the second CMBF filter the multi-spectral light incident thereupon to output filtered light towards the subject for reflection as reflected light; and

a camera which captures video images of the subject and generates corresponding video information and a synchronization signal, the video information including a plurality of left and right image frame information, the camera receiving the reflected light reflected from the subject and passing through a pupil CMBF pair and a detection lens,

wherein the pupil CMBF includes a first pupil CMBF and a second pupil CMBF, the first pupil CMBF being identical to the first CMBF and the second pupil CMBF being identical to the second CMBF, and

wherein the detection lens includes one unpartitioned section that covers both the first pupil CMBF and the second pupil CMBF.

2. The endoscopic illumination system of claim **1**, wherein the camera is located at a distal end of an endoscope for capturing the video images of the subject located in front direction of the endoscope and providing a front view, and wherein the camera is movable to provide a different view which is different from the front view.

3. The endoscopic illumination system of claim **1**, further comprising:

a digital mirror array (DMA) which receives the multi-spectral light and directs the multi-spectral light to a selected light path of one of the first and second light paths; and

a controller which controls the DMA to direct the multi-spectral light to the selected light path in accordance with a time-multiplexing scheme.

4. The endoscopic illumination system of claim **3**, further comprising an optics portion which receives the multi-spectral light from the DMA and collimates the multi-spectral light which is to be incident on a selected CMBF of the first CMBF and the second CMBF.

5. The endoscopic illumination system of claim **3**, further comprising a synchronizer which determines a delay interval Δt in accordance with the plurality of left and right image frame information, and generates a trigger signal in accordance with the synchronization signal and the delay interval Δt for each of the left and right image frame information.

6. The endoscopic illumination system of claim **5**, wherein the DMA controls timing of illumination to the selected light path in accordance with the trigger signal.

7. The endoscopic illumination system of claim **1**, further comprising transport optics which integrates the filtered light from at least one of the first CMBF and the second CMBF and transmits the filtered light along a third light path to illuminate the subject.

8. An endoscopic illumination method for illuminating a subject for stereoscopic image capture, the illumination method controlled by a controller and comprising acts of: outputting multi-spectral light by a light source;

filtering, by a selected complementary multiband bandpass filter (CMBF) of a first CMBF and a second CMBF, the multi-spectral light incident thereon and outputting filtered light;

illuminating the subject using the filtered light for reflection from the subject as filtered light;

receiving by a camera the filtered light reflected from the subject and passing through a pupil CMBF pair and a detection lens for forming video images of the subject; capturing by the camera the video images of the subject; and

generating corresponding video information and a synchronization signal, the video information including a plurality of left and right image frame information, the synchronization signal corresponding to a start time of an act of capturing a left or a right image frame information of the plurality of left and right image frame information.

9. The endoscopic illumination method of claim **8**, wherein the pupil CMBF pair includes a first pupil CMBF and a second pupil CMBF, the first pupil CMBF being identical to the first CMBF and the second pupil CMBF being identical to the second CMBF, and wherein the detection lens includes one unpartitioned section that covers both the first pupil CMBF and the second pupil CMBF.

10. The endoscopic illumination method of claim **8**, further comprising an act of selectively passing, using a digital mirror array (DMA), the multi-spectral light to a selected light path of one of first and second light paths in accordance with a time-multiplexing scheme, the first light path including the first CMBF and the second light path including the second CMBF.

21

11. The endoscopic illumination method of claim 10, further comprising acts of:

receiving the multi-spectral light passed by the DMA; and collimating the multi-spectral light which is to be incident on the selected CMBF.

12. The endoscopic illumination method of claim 10, further comprising acts of:

integrating the filtered light from the selected CMBF; and transmitting the filtered light along a third light path to illuminate the subject.

13. The endoscopic illumination method of claim 10, further comprising acts of:

determining a delay interval Δt in accordance with the plurality of left and right image frame information; and generating a trigger signal in accordance with the synchronization signal and the delay interval Δt for each of the left and right image frames.

14. The endoscopic illumination method of claim 13, further comprising an act of controlling timing of illumination to the selected light path in accordance with the trigger signal.

15. A non-transitory computer readable medium embodying computer instructions to control illumination of a subject for stereoscopic image capture, wherein the computer instructions, when executed by a processor, configure the processor to control a system for performing the act of:

causing a light source to output multi-spectral light for filtering, by a selected complementary multiband band-pass filter (CMBF) of the first CMBF and the second CMBF, the multi-spectral light incident on the selected CMBF, for outputting filtered light, and for illuminating the subject using the filtered light;

causing a camera to capture video images of the subject by receiving the filtered light reflected from the subject and passing through a pupil CMBF pair and a detection lens for forming the video images of the subject; and generating corresponding video information and a synchronization signal, the video information including a plurality of left and right image frame information, the synchronization signal corresponding to a start time of an act of capturing a left or a right image frame information of the plurality of left and right image frame information.

16. The non-transitory computer readable medium of claim 15, wherein the pupil CMBF pair includes a first pupil CMBF and a second pupil CMBF, the first pupil CMBF being identical to the first CMBF and the second pupil CMBF being identical to the second CMBF, and wherein the detection lens includes one unpartitioned section that covers both the first pupil CMBF and the second pupil CMBF.

17. The non-transitory computer readable medium of claim 15, wherein the computer instructions further configure the processor to control the system for performing an act of causing a digital mirror array (DMA) to selectively pass the multi-spectral light to a selected light path of one of first and second light paths in accordance with a time-multiplexing scheme, the first light path including the first CMBF and the second light path including the second CMBF.

22

18. The non-transitory computer readable medium of claim 17, wherein the computer instructions further configure the processor to control the system for performing the act of:

receiving the multi-spectral light passed by the DMA; and collimating the multi-spectral light which is to be incident on the selected first or second CMBFs.

19. The non-transitory computer readable medium of claim 17, wherein the computer instructions further configure the processor to control the system for performing the act of:

integrating the filtered light from the selected CMBF; and transmitting the filtered light along a third light path to illuminate the subject.

20. The non-transitory computer readable medium of claim 17, wherein the computer instructions further configure the processor to control the system for performing the act of:

determining a delay interval Δt in accordance with the plurality of left and right image frame information; generating a trigger signal in accordance with the synchronization signal and the delay interval Δt for each of the left and right image frames; and controlling timing of illumination to the selected light path in accordance with the trigger signal.

21. An endoscopic system for illuminating a subject for stereoscopic image capture, the illumination system comprising:

a processor; and

a memory operatively coupled to the processor, wherein the processor is configured to:

cause a light source to output multi-spectral light for filtering, by a selected complementary multiband band-pass filter (CMBF) of a first CMBF and a second CMBF, the multi-spectral light incident on the selected CMBF, for outputting filtered light, and for illuminating the subject using the filtered light;

cause a camera to capture video images of the subject by receiving the filtered light reflected from the subject and passing through a pupil CMBF pair and a detection lens for forming the video images of the subject; and generate corresponding video information and a synchronization signal, the video information including a plurality of left and right image frame information, the synchronization signal corresponding to a start time of an act of capturing a left or a right image frame information of the plurality of left and right image frame information.

22. The endoscopic system of claim 21, wherein the processor is further configured to cause a digital mirror array (DMA) to selectively pass the multi-spectral light to a selected light path of one of first and second light paths in accordance with a time-multiplexing scheme, the first light path including the first CMBF and the second light path including the second CMBF.

* * * * *