

MODELING A PACKED BED REACTOR UTILIZING THE SABATIER PROCESS

Malay G. Shah, Anne J. Meier, Paul E. Hintze
NASA, Kennedy Space Center, FL 32899

ABSTRACT

A numerical model is being developed using Python which characterizes the conversion and temperature profiles of a packed bed reactor (PBR) that utilizes the Sabatier process; the reaction produces methane and water from carbon dioxide and hydrogen. While the specific kinetics of the Sabatier reaction on the Ru/Al₂O₃ catalyst pellets are unknown, an empirical reaction rate equation¹ is used for the overall reaction. As this reaction is highly exothermic, proper thermal control is of the utmost importance to ensure maximum conversion and to avoid reactor runaway. It is therefore necessary to determine what wall temperature profile will ensure safe and efficient operation of the reactor. This wall temperature will be maintained by active thermal controls on the outer surface of the reactor.

Two cylindrical PBRs are currently being tested experimentally and will be used for validation of the Python model. They are similar in design except one of them is larger and incorporates a preheat loop by feeding the reactant gas through a pipe along the center of the catalyst bed. The further complexity of adding a preheat pipe to the model to mimic the larger reactor is yet to be implemented and validated; preliminary validation is done using the smaller PBR with no reactant preheating. When mapping experimental values of the wall temperature from the smaller PBR into the Python model, a good approximation of the total conversion and temperature profile has been achieved.

A separate CFD model incorporates more complex three-dimensional effects by including the solid catalyst pellets within the domain. The goal is to improve the Python model to the point where the results of other reactor geometry can be reasonably predicted relatively quickly when compared to the much more computationally expensive CFD approach. Once a reactor size is narrowed down using the Python approach, CFD will be used to generate a more thorough prediction of the reactor's performance.

NOMENCLATURE, ACRONYMS, ABBREVIATIONS

CFD	Computational fluid dynamics
PBR	Packed bed reactor
Ru/Al ₂ O ₃	Ruthenium on aluminum oxide

REFERENCES

1. Lunde, P. J., & Kester, F. L. (1973). Rates of Methane Formation from Carbon Dioxide and Hydrogen Over a Ruthenium Catalyst. *Journal of Catalysis*, 423-429.



Modeling a Packed Bed Reactor Utilizing the Sabatier Process

Malay Shah, Anne Meier, Paul Hintze
(NASA - KSC)

Presented By
Malay Shah



TFAWS
MSFC • 2017

Thermal & Fluids Analysis Workshop
TFAWS 2017
August 21-25, 2017
NASA Marshall Space Flight Center
Huntsville, AL

- What is the Sabatier process?

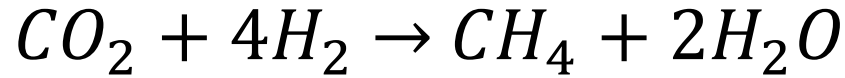

$$\Delta H = -165.0 \text{ kJ/mol}$$

- Reactor utilizes Ru/Al₂O₃ catalyst pellets
 - Very high selectivity for CH₄ production
- Sample Reactor Design [1]
 - Preheat feed gas using excess heat

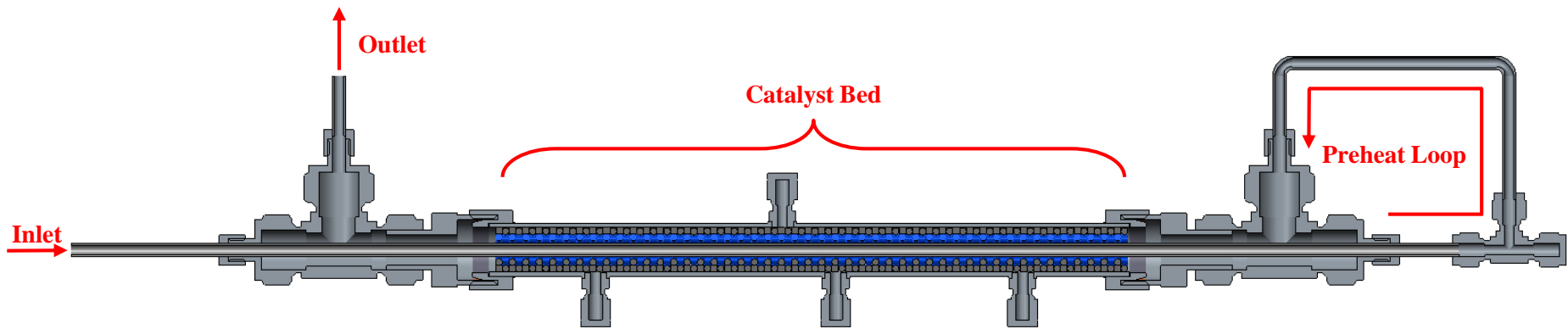



Project Background

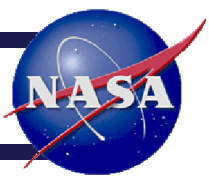

- Application:
 - Fuel on Mars!
- Why is modeling important?
 - Estimate reactor hot spots
 - Implement proper thermal control
 - Prevent catalyst degradation
 - Predict scaled-up performance
- Modeling methodology:
 - Simplified 1D model written in Python
 - Very quick and gives good estimates
 - Good initial guess to further investigate using CFD
 - Traditional CFD
 - Longer to simulate, but may provide better reactor information

- Reactor Dimensions
 - 0.43" diameter
 - 1.75" & 3.5" length
 - 0.125" x 0.125" Cylindrical pellets

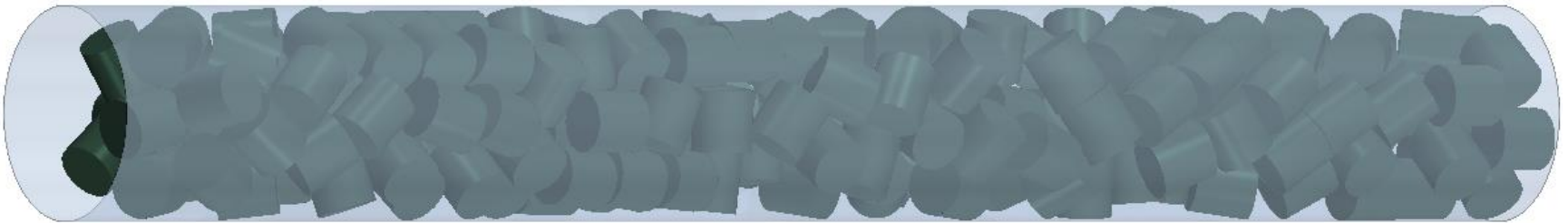

- Assumptions

- Steady-state
- 1D porous media approximation
- No intermediate reactions
- Catalyst effectiveness factor = 1

- Reaction Rate

- Ruthenium Catalyst: Empirical correlation [2]

$$r = k_0 \exp(-E_a/RT) \left\{ [p_{CO_2}]^n [p_{H_2}]^{4n} - \frac{[p_{CH_4}]^n [p_{H_2O}]^{2n}}{[K_e(T)]^n} \right\} / (RT)$$

- Nickel Catalyst: Hougen-Watson type [3]

$$r = \frac{k_1 K_{CO_2} K_{H_2}^4 p_{CO_2} p_{H_2}^4}{(1 + K_{CO_2} p_{CO_2} + K_{H_2} p_{H_2})^5} (1 - \beta)$$

$$\beta = \frac{1}{K_e(T)} \frac{p_{CH_4} p_{H_2O}^2}{p_{CO_2} p_{H_2}^4}$$

- Pressure Drop

- Bed-to-particle diameter ratio is 3.4, so wall effects are not entirely negligible
- Use Reichalt correlation instead of Ergun [4]

- Heat Transfer

- Thermal resistance method
 - Convection along inner wall
 - Effective radial conduction through bed
- Many correlations!
 - Martin & Nilles: Convective heat transfer coefficient
 - Winterberg: Effective bed thermal conductivity
 - Zehner & Schlunder: Effective stagnant bed thermal conductivity

$$\frac{1}{U_{eff}} = \frac{1}{h} + \frac{1}{6} \left(\frac{Bi + 3}{Bi + 4} \right) \frac{D_h}{k_{eff}}$$

- Differential Equations

$$\frac{dN_i}{dV} = v_i \eta r$$

$$\frac{dT}{dV} = \frac{-\Delta H_R r + \frac{4U_{eff}}{D_h} (T_w - T)}{\sum_i N_i C p_i}$$

$$\frac{dP}{dV} = -\frac{MW}{Ac} \left[\frac{190A_w^2 u_{avg} \mu (1 - \varepsilon)^2}{D_p^2 \varepsilon^3} + \frac{A_w u_{avg} \rho (1 - \varepsilon)}{B_w D_p \varepsilon^3} \right]$$

$$A_w = 1 + \frac{2}{3(D_h/D_p)(1 - \varepsilon)} \quad B_w = \left[2.00 \left(\frac{D_p}{D_h} \right)^2 + 0.77 \right]^2$$



Model Information

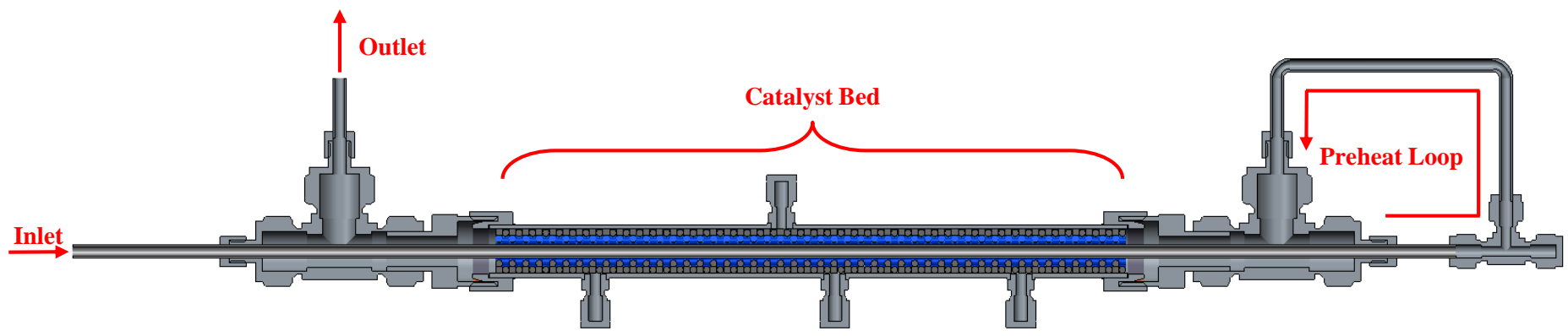
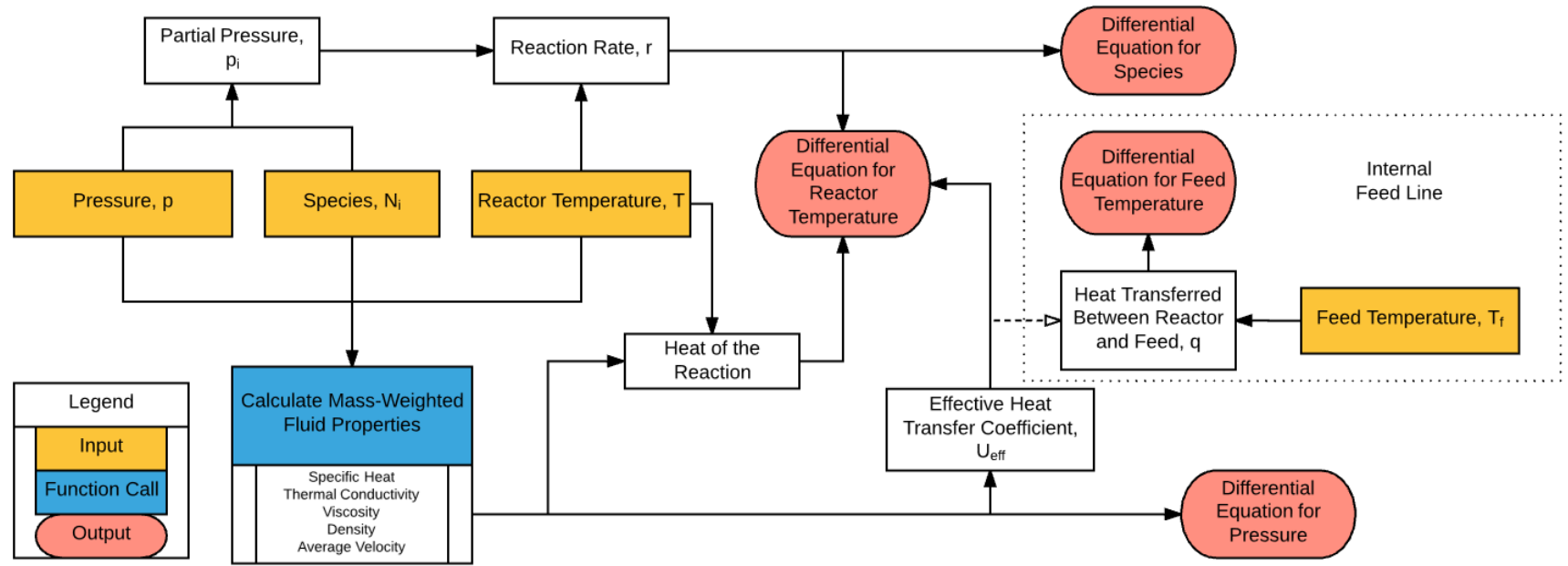

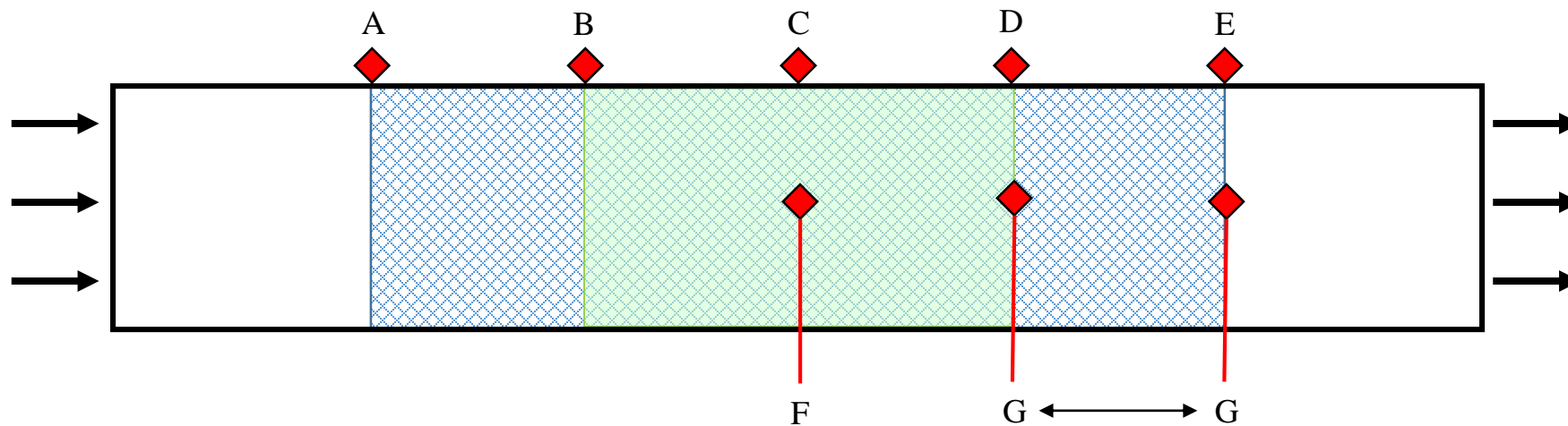

Catalyst bed volume mL	CO ₂ /H ₂ flow rate SCCM	Thermocouple, °C							Conversion X
		A	B	C	D	E	F catalyst bed middle	G catalyst bed outlet	
2.3	40/200	225	295	314	295	258	376	293	98
2.3	80/400	106	236	289	259	175	417	259	96
2.3	120/600	93	282	366	333	219	523	337	97
2.3	160/800	85	298	416	395	267	570	407	93
6.3	150/750	347	391	362	295	249	399	252	98
6.3	165/825	350	408	383	314	264	424	271	99
6.3	225/1125	364	455	454	398	345	501	355	97
6.3	275/1375	361	472	484	440	390	531	405	91
6.3	300/1500	355	478	494	456	410	542	427	85
6.3	350/1750	336	486	511	481	437	558	460	91
6.3	375/1825	329	485	516	489	449	564	471	82
6.3	425/2125	253	467	530	512	475	579	500	80

Catalyst bed volume mL	CO ₂ /H ₂ flow rate SCCM	Thermocouple, °C							Conversion %
		A	B	C	D	E	F catalyst bed middle	G catalyst bed outlet	X
2.3	40/200	225	295	314	295	258	376	293	98
									83

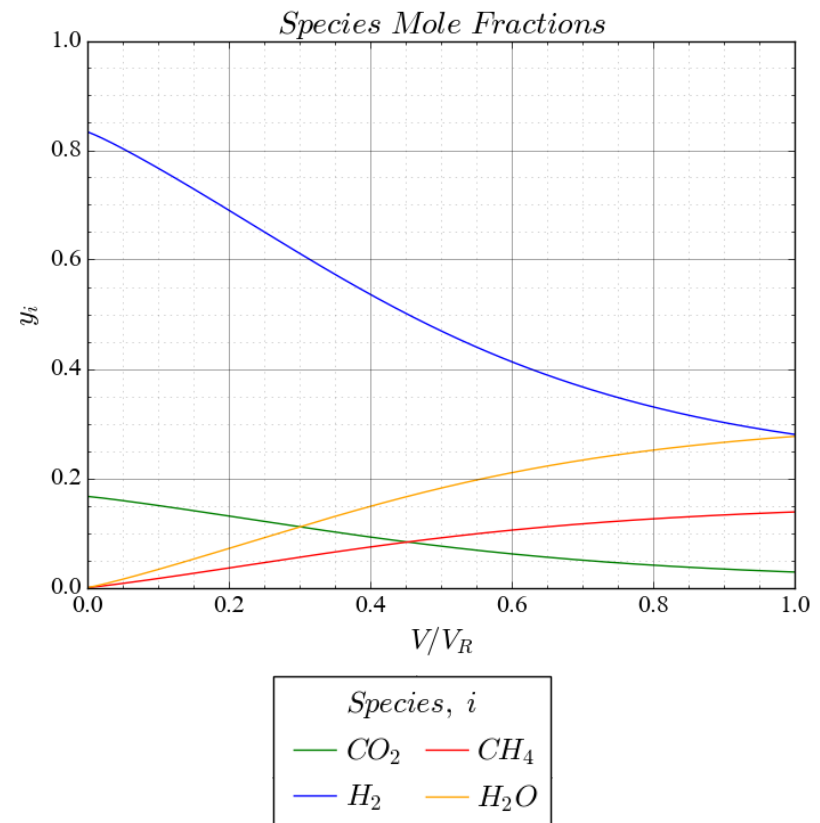
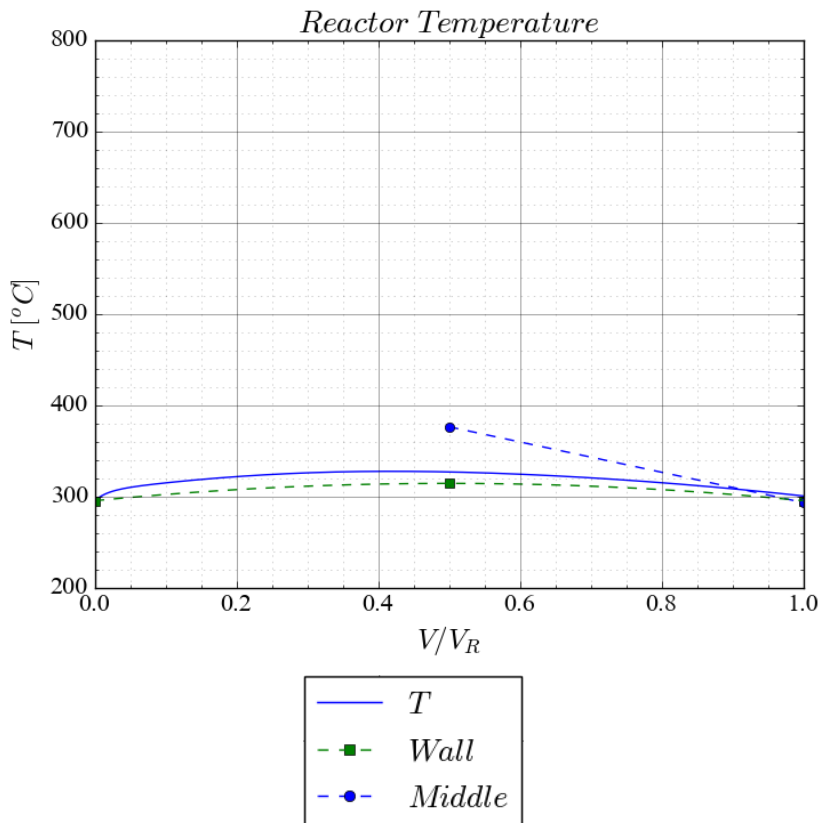
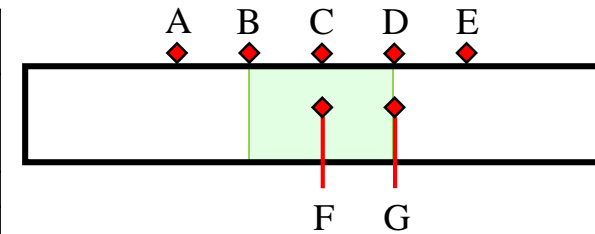

Catalyst bed volume	CO ₂ /H ₂ flow rate	Thermocouple, °C							Conversion %
mL	SCCM	A	B	C	D	E	F catalyst bed middle	G catalyst bed outlet	X
2.3	120/600	93	282	366	333	219	523	337	97
									91

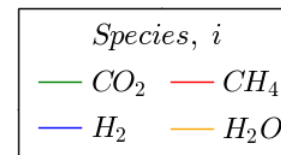
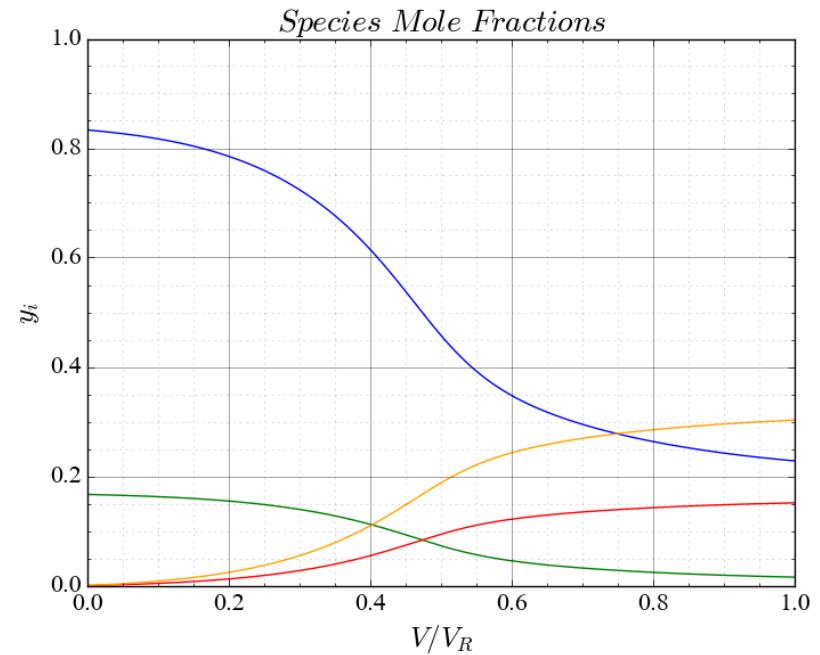
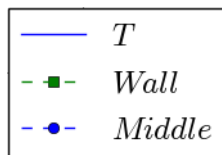
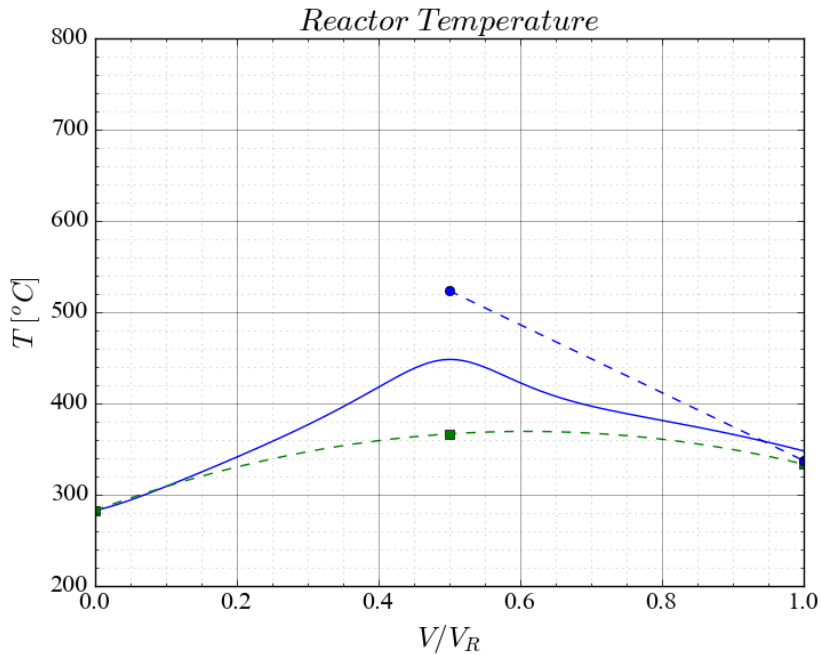
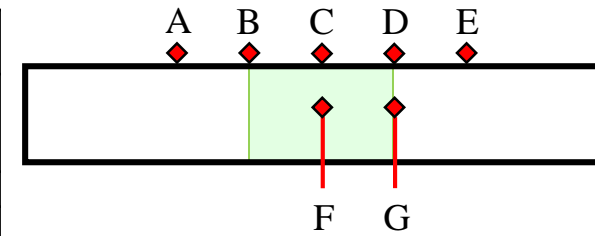

Catalyst bed volume	CO ₂ /H ₂ flow rate	Thermocouple, °C							Conversion %
mL	SCCM	A	B	C	D	E	F catalyst bed middle	G catalyst bed outlet	X
2.3	160/800	85	298	416	395	267	570	407	93
									97

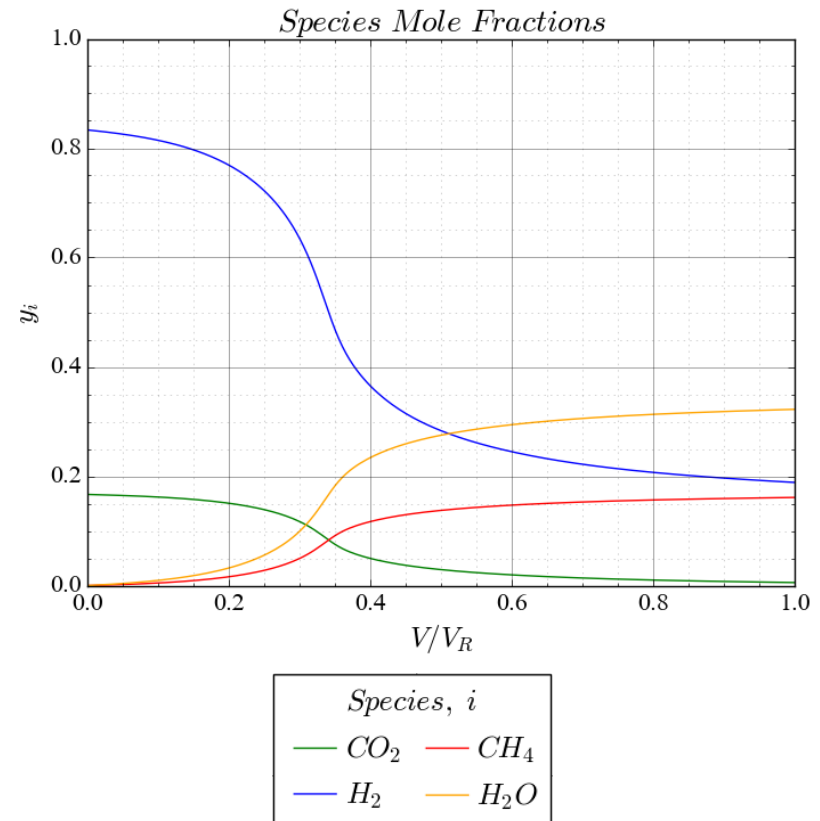
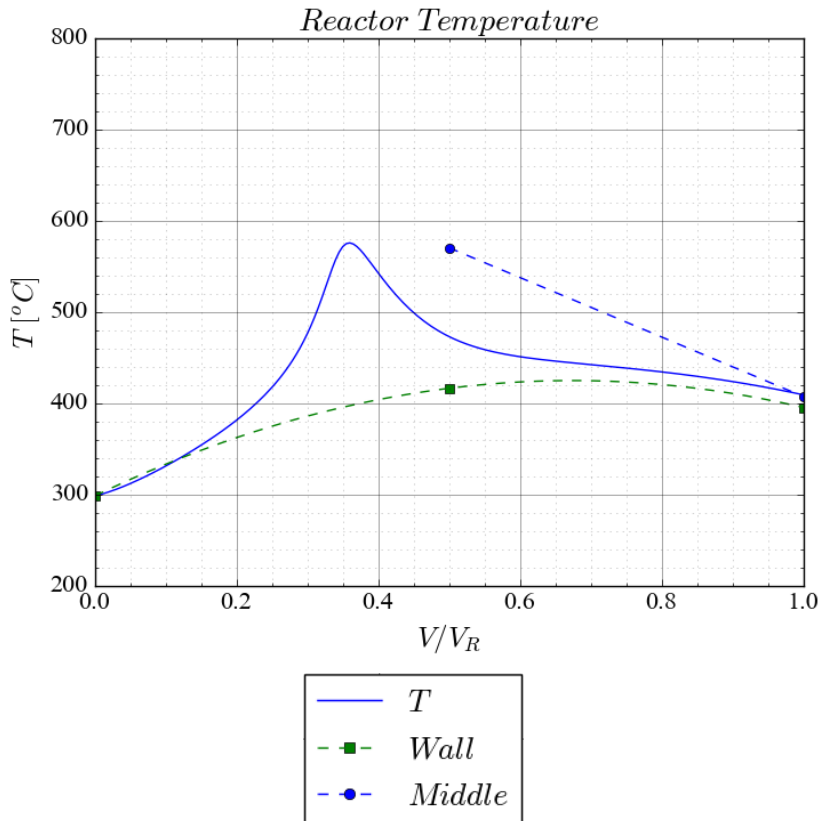
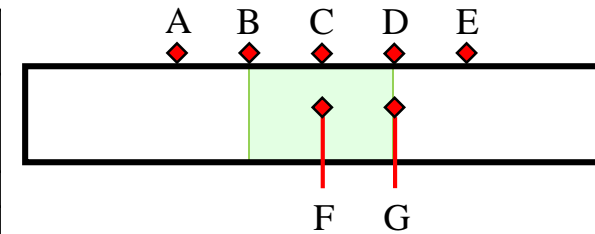

Catalyst bed volume	CO ₂ /H ₂ flow rate	Thermocouple, °C							Conversion %
mL	SCCM	A	B	C	D	E	F catalyst bed middle	G catalyst bed outlet	X
6.3	150/750	347	391	362	295	249	399	252	98
									100

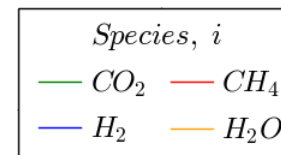
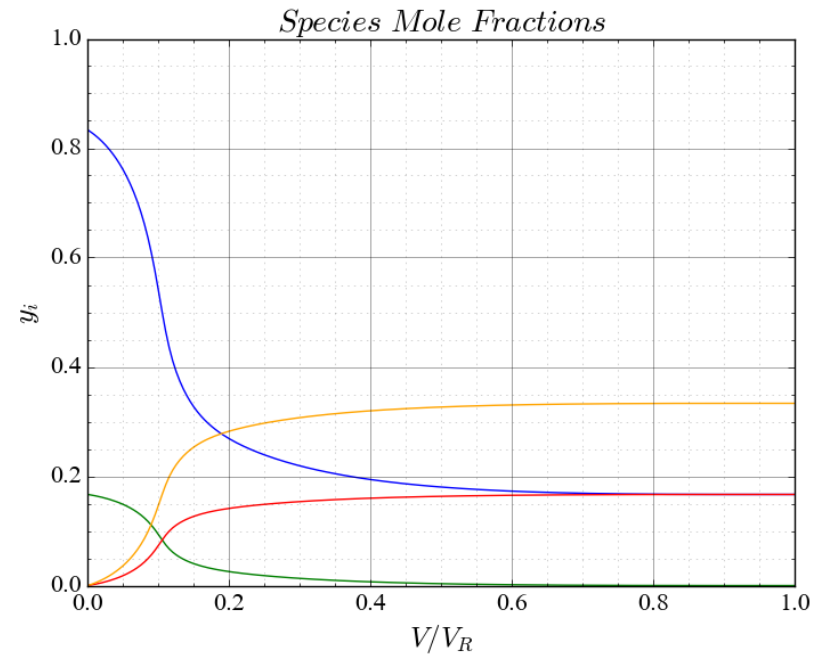
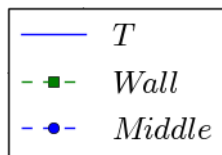
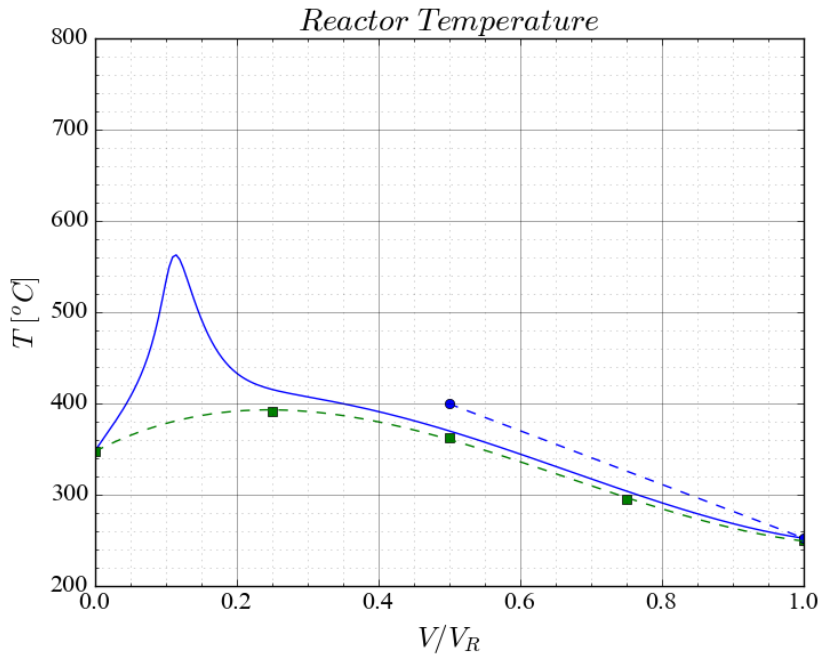
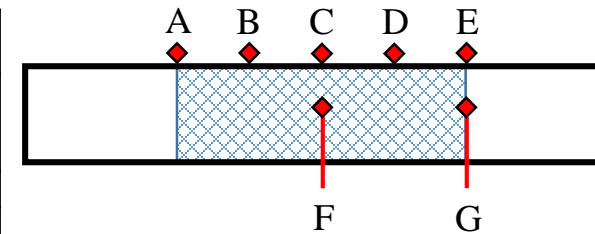

Catalyst bed volume	CO ₂ /H ₂ flow rate	Thermocouple, °C							Conversion %
mL	SCCM	A	B	C	D	E	F catalyst bed middle	G catalyst bed outlet	X
6.3	300/1500	355	478	494	456	410	542	427	85
									96

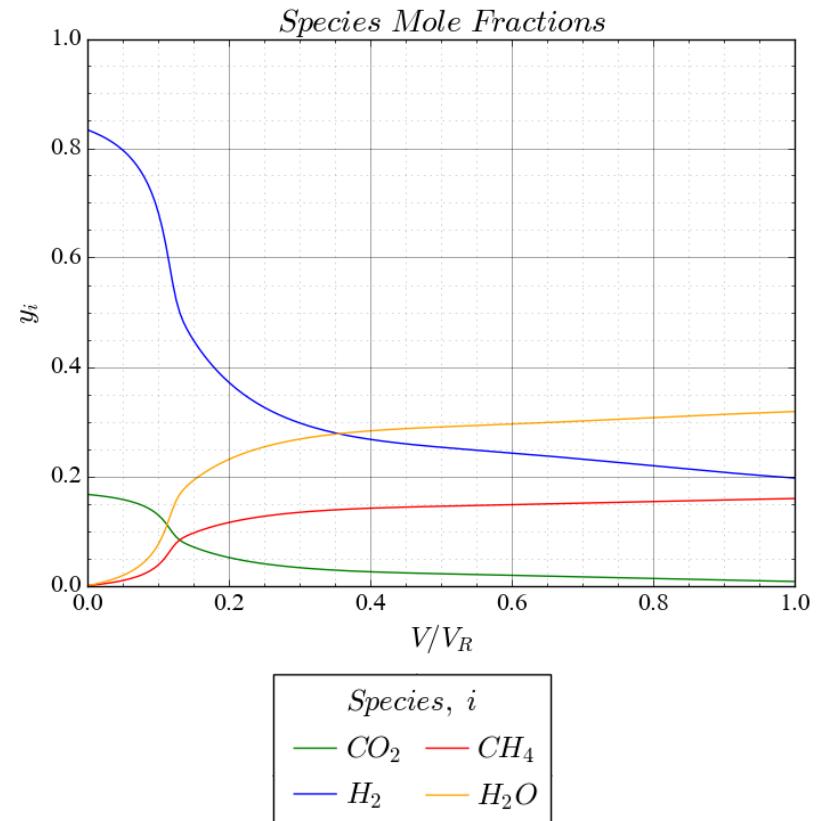
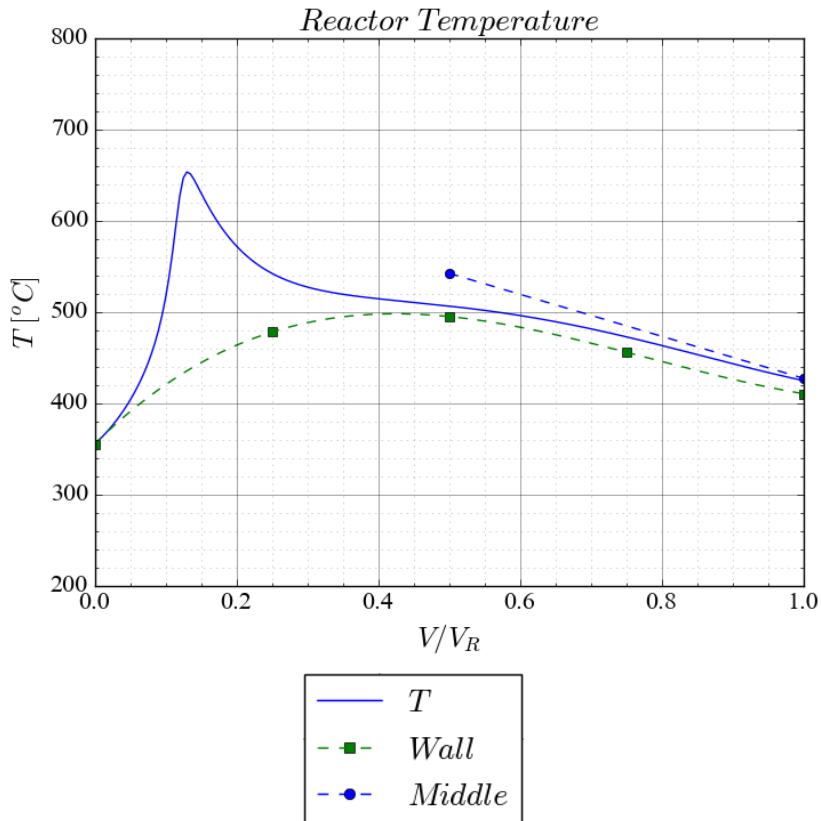
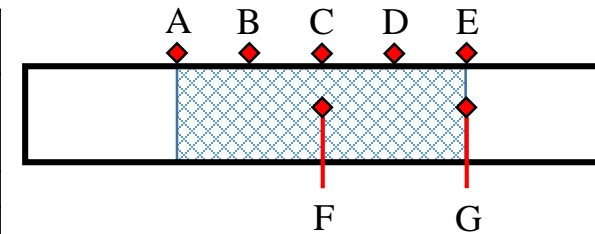

Catalyst bed volume	CO ₂ /H ₂ flow rate	Thermocouple, °C							Conversion %
mL	SCCM	A	B	C	D	E	F catalyst bed middle	G catalyst bed outlet	X
6.3	425/2125	253	467	530	512	475	579	500	80
									87

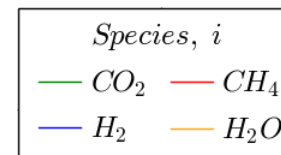
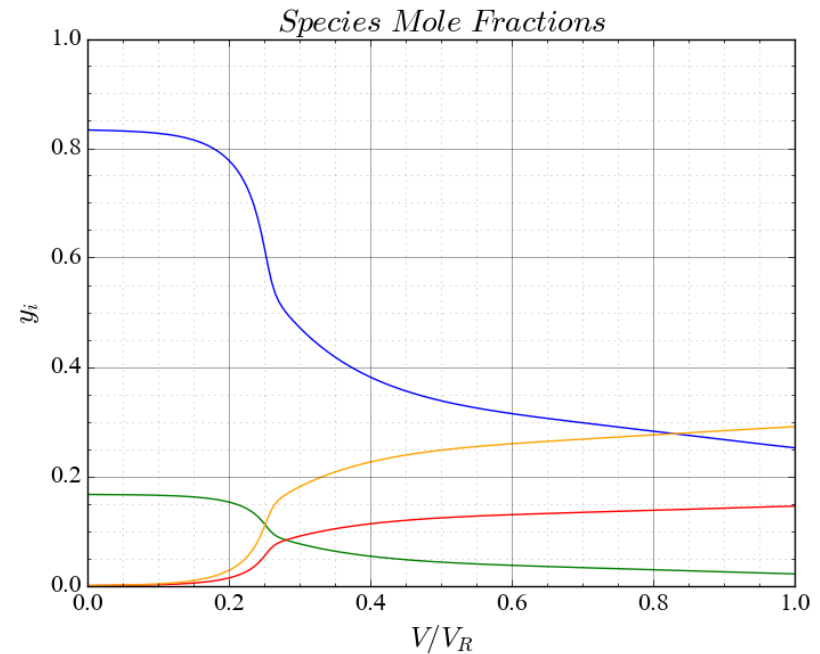
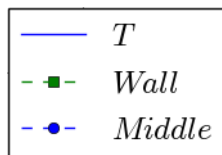
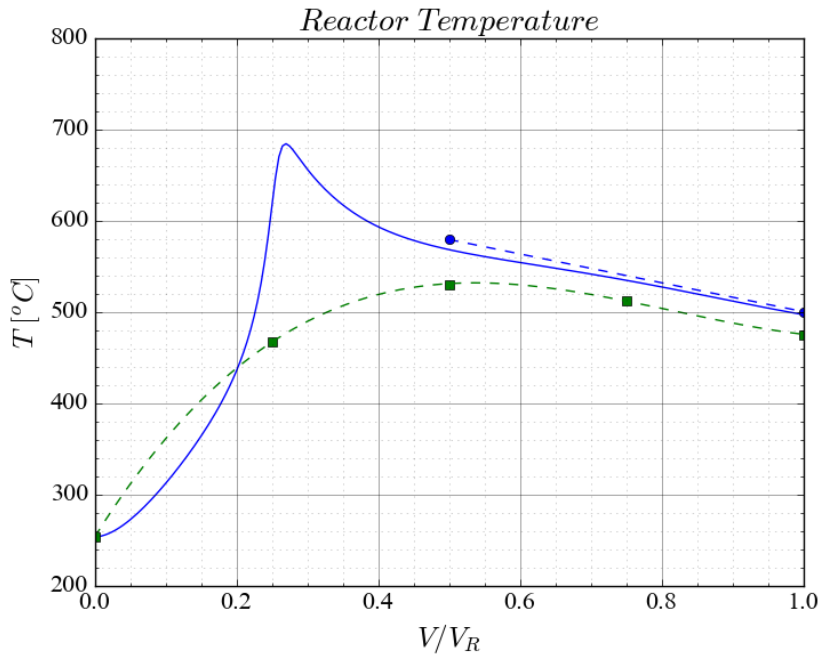
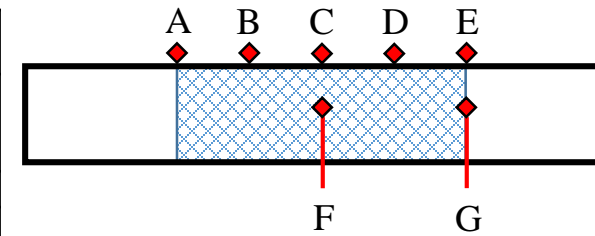



Future Work

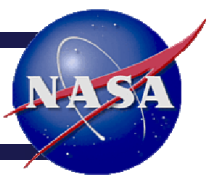

- **Additional Experiments:**
 - Larger reactor currently being tested
 - Radial profile to be captured
- **Python model:**
 - Increase complexity
 - Radial profiles important!
 - Catalyst effectiveness
 - Refine boundary conditions
 - Validate against additional tests
- **CFD Model:**
 - Catalyst surface reaction
 - May require more information on reaction kinetics

- Software: STAR-CCM+
- Catalyst pellets injected using Discrete Element Method (DEM) particles
 - Fluid volume gathered from subtracting resulting solid volume
- Species Source Terms
 - Reaction modeled using field functions

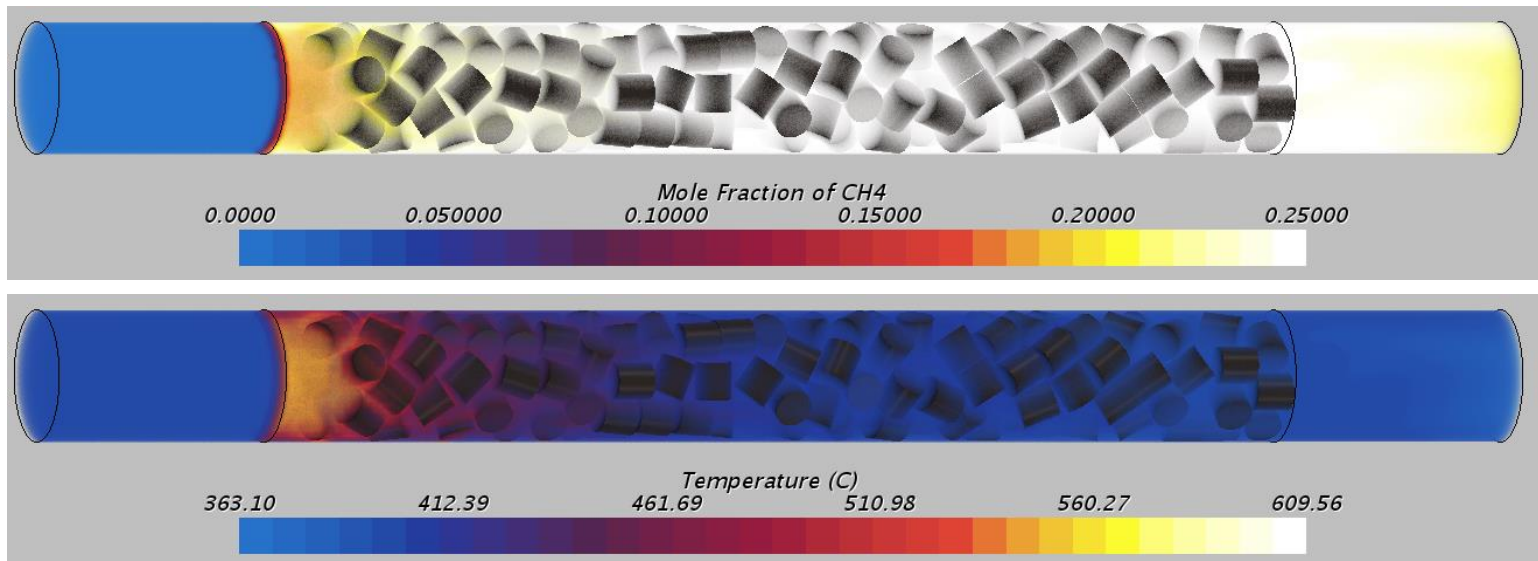

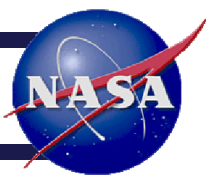

References

1. Meier, A., Shah, M., Hintze, P., Muscatello, A., Petersen, E., “Mars Atmospheric Conversion to Methane and Water: An Engineering Model of the Sabatier Reactor with Characterization of Ru/Al₂O₃ for Long Duration Use on Mars,” *International Conference on Environmental Systems*, 2017, ICES-2017-161.
2. Lunde, P. J., and Kester, F. L., “Rates of methane formation from carbon dioxide and hydrogen over a ruthenium catalyst,” *Journal of catalysis*, vol. 30, 1973, pp. 423–429.
3. Quatch, T. Q., and Rouleau, D., “Kinetics of the reaction between carbon dioxide and hydrogen over a ruthenium catalyst in a continuous stirred tank reactor,” *Journal of Applied Chemistry and Biotechnology*, vol. 26, 1976, pp. 527–535.
4. Reichelt, W., “Zur Berechnung des Druckverlustes einphasig durchströmter Kugel-und Zylinderschüttungen,” *Chemie Ingenieur Technik*, vol. 44, 1972, pp. 1068–1071.