



# Increment 53 / 54 Science Symposium

## Advanced Colloids Experiment (Temperature controlled) – ACE-T6

PI: Dr. Matthew Lynch – Procter & Gamble Company (P&G) – CASIS/SLPSRA



Presented by:

Dr. William V. Meyer (*a.k.a.* Bill Meyer)

ACE NASA Project Scientist

USRA at NASA GRC, Tel: (216) 433-5011, Email: [William.V.Meyer@NASA.Gov](mailto:William.V.Meyer@NASA.Gov)

ACE NASA Project Manager: Ron Sicker, Tel.: (216) 433-6498

ZIN-Technologies ACE Project Manager: Kelly Bailey, Tel: (440) 625-2251

ZIN-Technologies Science Lead: John Eustace, Tel: (440) 625-2244



July 12, 2017

# LONG-TIME COARSENING OF BIMODAL COLLOIDAL GELS STUDIED IN MICROGRAVITY



Matthew Lynch- the Procter & Gamble Company

Tom Kodger – Harvard University, University of Amsterdam

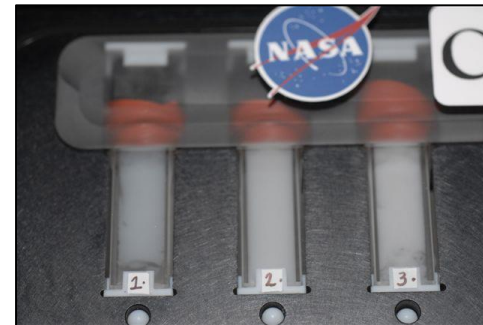

“P&G products improve the lives of 4.8 billion people every day, which is more than  $\frac{1}{2}$  of the planet’s population... aim to reach them all...”

# ACE-T9 Science Team Contact Information



Dr. Matthew Lynch  
Principal Scientist, Colloid and Surfactant Laboratory  
Procter & Gamble Company  
Winton Hill Technical Center BB2S568A  
6280 Center Hill Ave.  
Cincinnati, OH 45224-1708  
Tel.: (513) 668-8073  
E-mail: [lynch.ml@pg.com](mailto:lynch.ml@pg.com)

# ISS Increments 53 and 54 Science Symposium

Advanced Colloids Experiment (Temperature controlled) – ACE-T6:  
Matthew Lynch – Procter & Gamble Company (P&G)

- Science Background and Hypothesis
- Investigation goals and objectives
- Measurement approach
- Importance and reason for ISS
- Expected results and how they will advance the field
- Earth benefits/spin-off applications

# Science Background and Hypothesis – 1/2

Precious little is known about the coarsening of real-world colloidal gels. Most academic research has been done in idealized, mono-dispersed systems, where the various components in the dispersion are of a single size. However, recent work (Lynch, Weitz – listed below) demonstrated that polydispersity, or multiple sizes of particles in the polymer, makes a huge difference in the time scale of coarsening of weak gels, in many cases in excess of several orders of magnitude in time. Commercial systems are necessarily polydispersed systems, this being complicated and not well understood. There are at present no basic measurements/theories that allow us to understand the role of polydispersity in these processes. As a consequence, the ability to design effective products is hugely complicated.

To control these systems, an understanding of the evolution (coarsening) of microstructure is required. On earth this process occurs on a timescale of minutes due to gravitational sedimentation; while on the International Space Station (ISS) the timescale will be several days to weeks in duration. Microgravity is required to detach phase separation from coarsening. This is crucial for the practical application of these concepts to product design, as products are inherently polydisperse - the basic need.

J. J. Lietor-Santos, C. Kim, M. L. Lynch, A. Fernandez-Nieves, D. A. Weitz, [The Role of Polymer Polydispersity in Phase Separation and Gelation in Colloid-Polymer Mixtures](#), *Langmuir* 26, 3174 (2010).

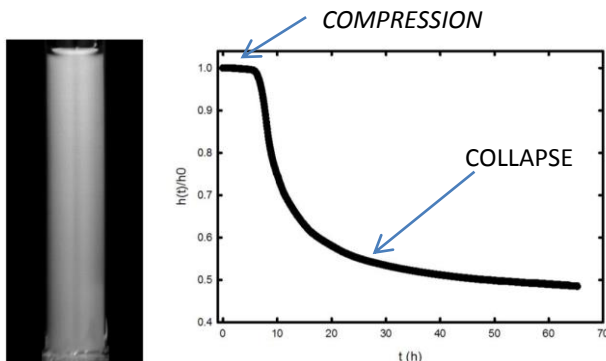

SEPARATION OF GELS IS  
COMPLEX AND  
UNPREDICTABLE



## Science Background and Hypothesis – 2/2

Fundamental science and colloidal engineering can be pursued and understood directly at a particle level.

Microscopy enables scientists to directly observe what is happening at a colloid particle level - one no longer requires a theoretical model to hope to connect macroscopic experimental observations to microscopic ones (as when observing experiments at the size scale seen with a photograph taken of a BCAT or PCS sample).

# APPROACH TO THE PROBLEM - PARTICLE GELS

Particulate gels formed by the aggregation of small colloidal particles

STRANDS

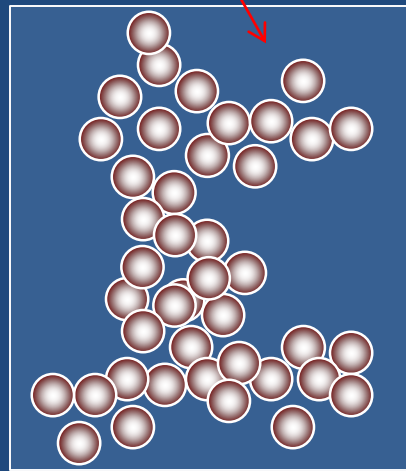

↔  
1 micron

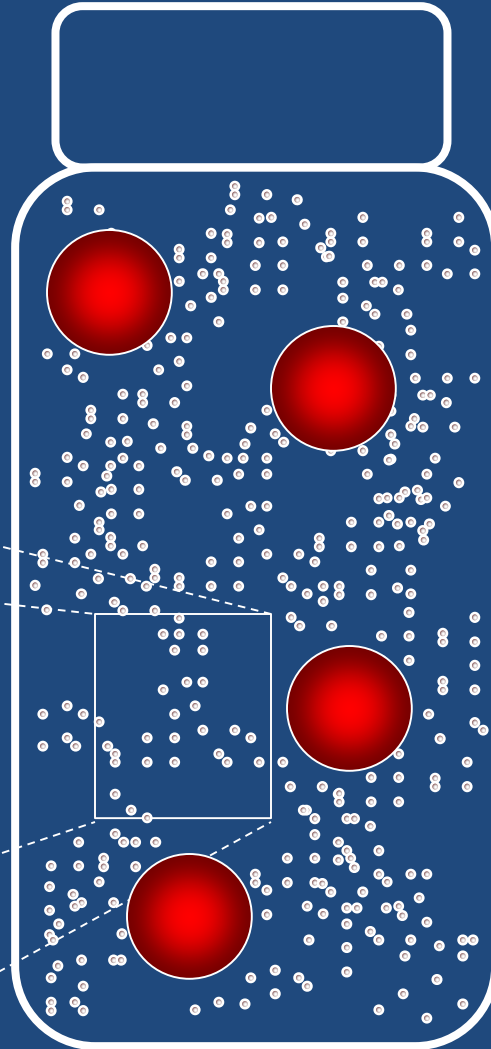

YIELD STRESS  
CONDITIONS

$$\sigma_{app} \gg \sigma_{ys} \gg \sigma_{part}$$

- Set up an infinite viscosity at ambient condition
- Set up zero viscosity under stress or flow conditions

# SEDIMENTATION FACITATED BY CRACKING

Crack formation

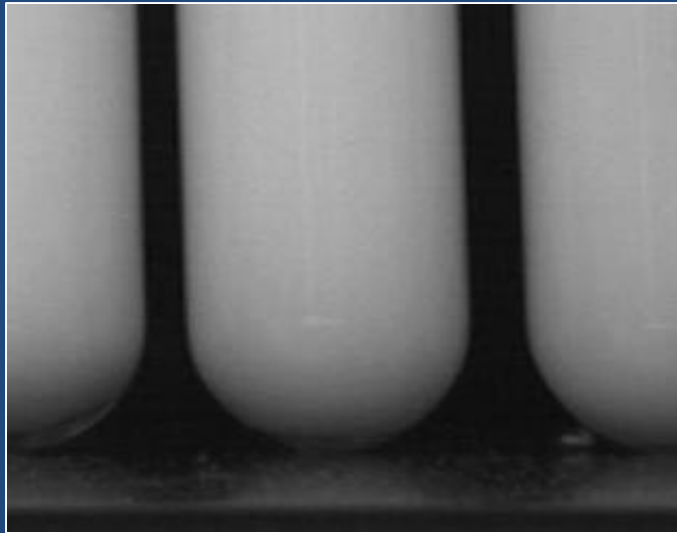

Initial

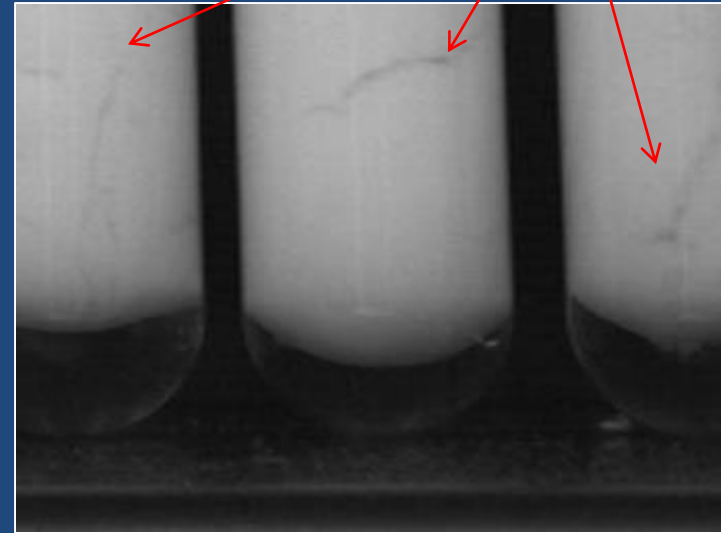

5 hours



# STRUCTURES- NOT STATIC, BUT COARSENING

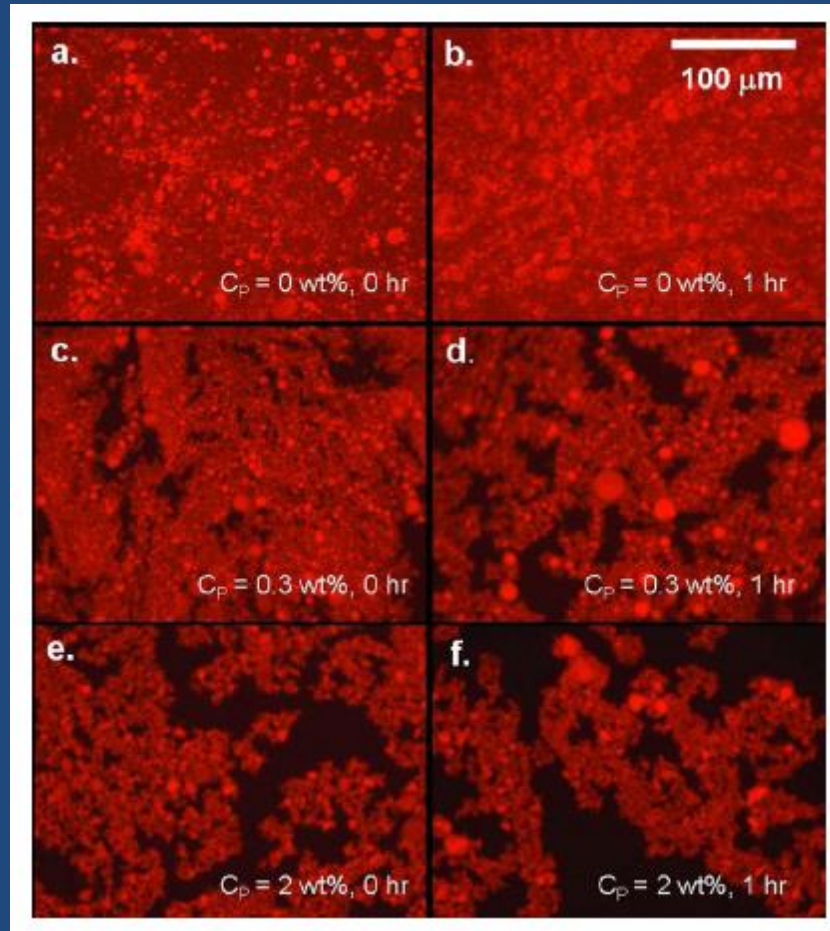

# DISPERSED IN POLYMER SOLUTION TO CREATE SAMPLES for ACE-M1

Sample #	$\chi$ (N_small / N_big)	$\phi$	Conc. Polymer (mg/ml) *
1	1	0.05	2
2	1	0.05	1.5
3	1	0.05	1.4
4	1	0.05	1.3
5	1	0.05	1.2
6	1	0.05	1.1
7	1	0.05	1.0
8	1	0.05	0.9
9	1	0.05	0.8
10	1	0.05	0.5

KEY

\* Polystyrene sulfonate (1 million MW,  $M_w/M_n$  at 1.3)

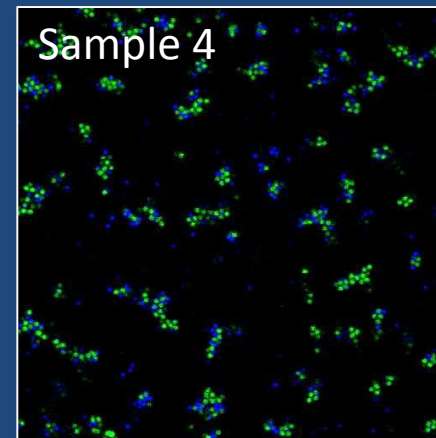
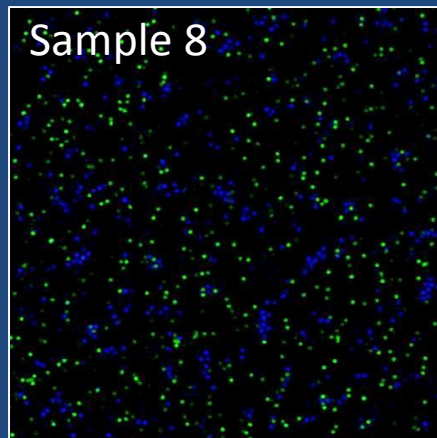

# MICROSCOPIC MEASUREMENTS - LMM FACILITY ON ISS

ACE sample cells

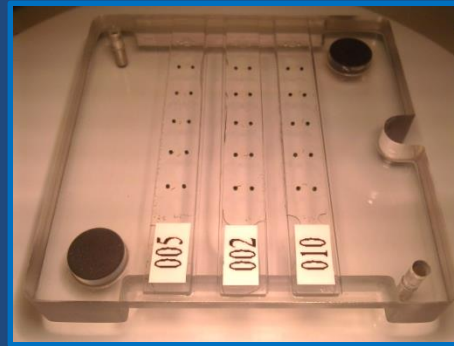
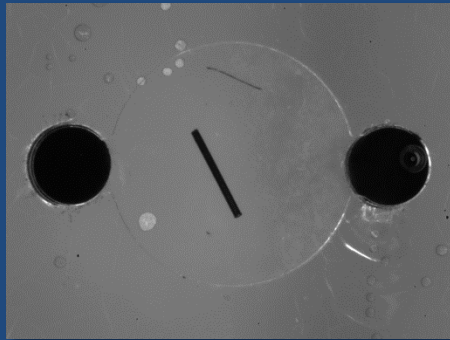

Data Collection

Big particles

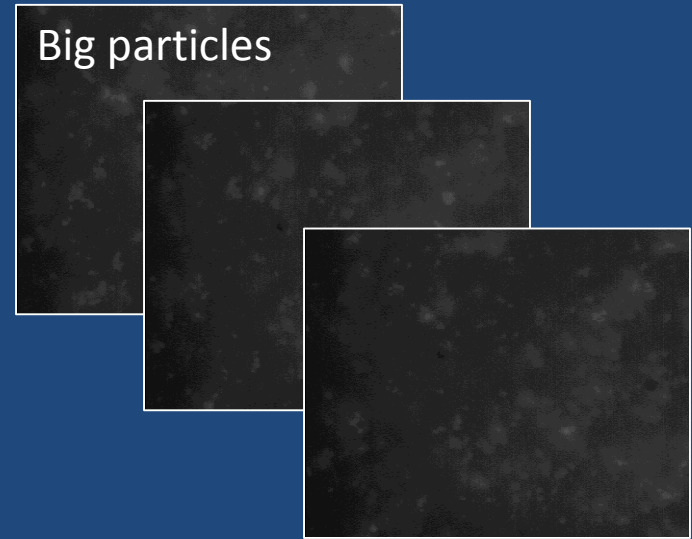

LMM microscope



Small particles

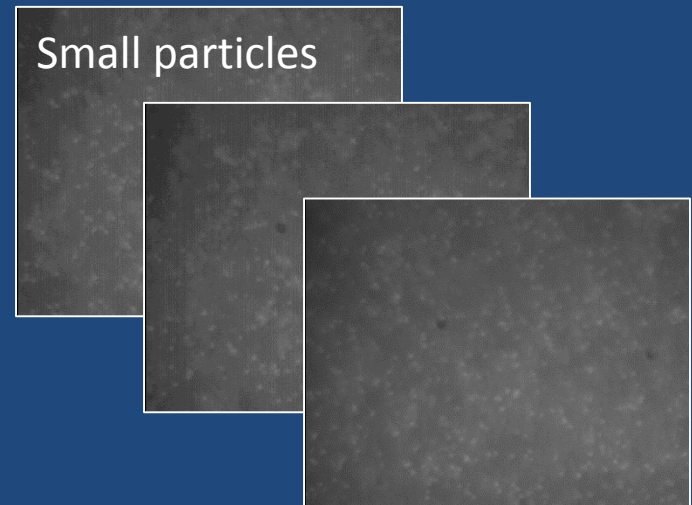

# ACE-M1 STRUCTURING WITH EXTENSIVE AGGREGATION

'STICKY' PARTICLES

60 X Mag

Sample 1 (Big)

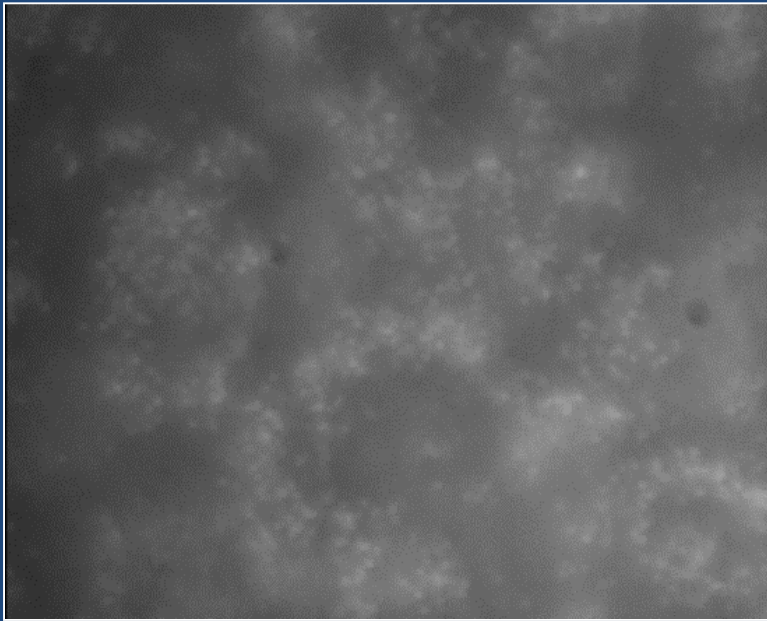

Large particles in  
strands

Sample 1 (Small)

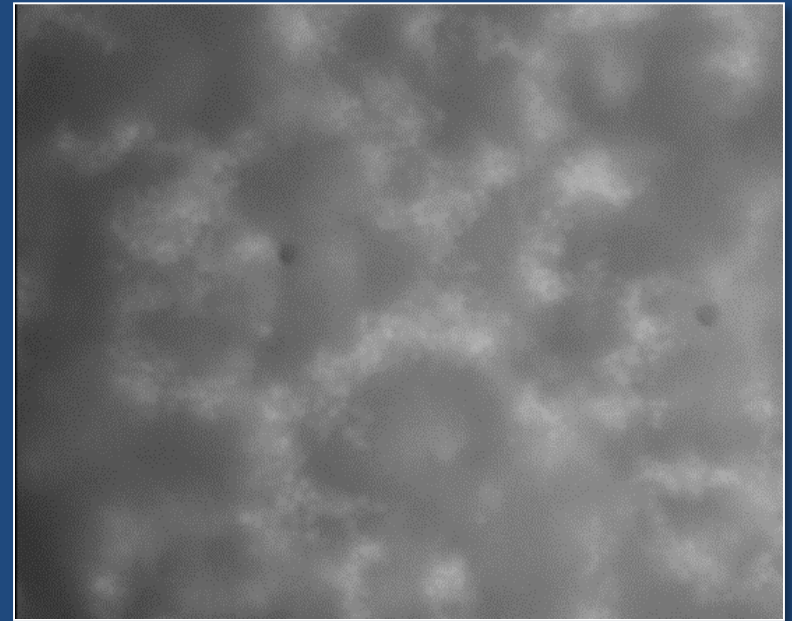

Small particles in  
strands

Conc. Polymer (2 mg/ml)

# ACE-M1 STRUCTURING WITH MODEST AGGREGATION

'MODERATELY-STICKY' PARTICLES

60 X Mag

Sample 4 (Big)

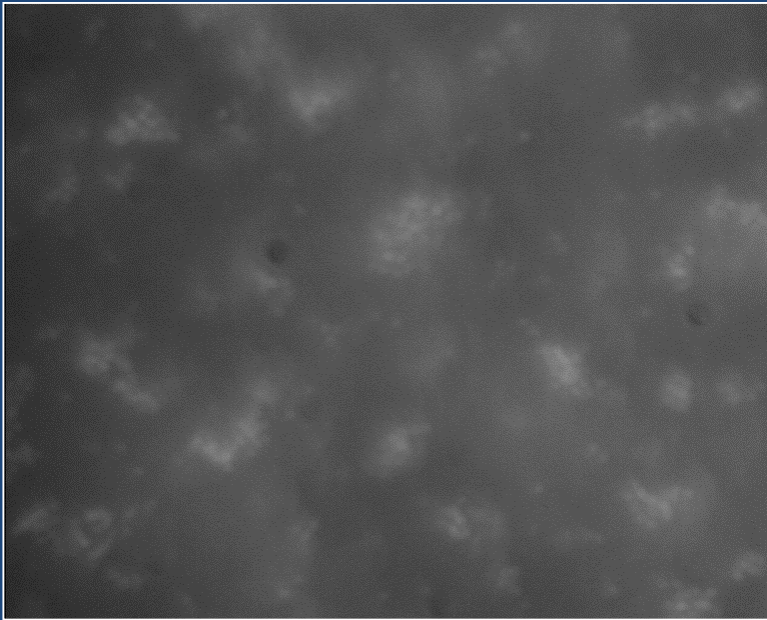

Large particles in  
strands

Sample 4 (Small)

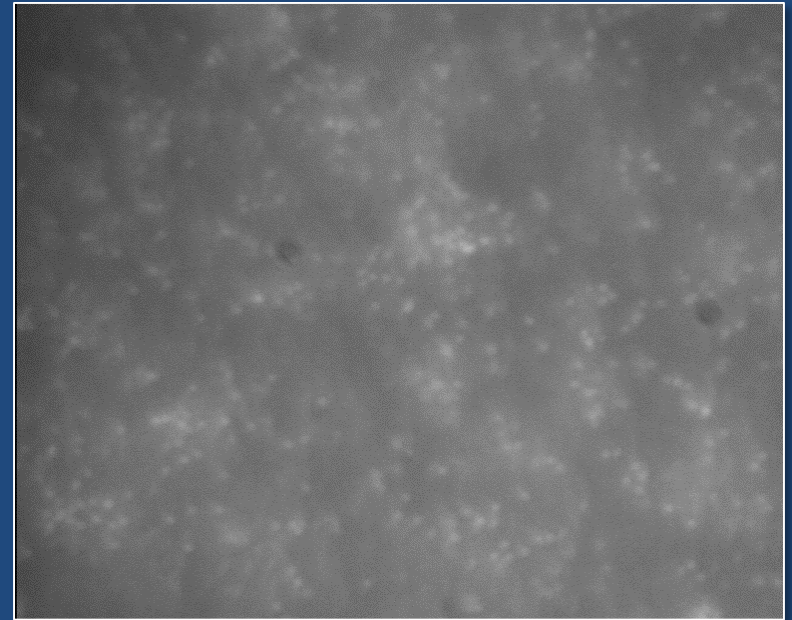

Small particles buzzing  
around

Conc. Polymer (1.3 mg/ml)

# ACE-M1 STRUCTURING WITH LITTLE AGGREGATION

'NON-STICKY' PARTICLES

60 X Mag

Sample 9 (Big)

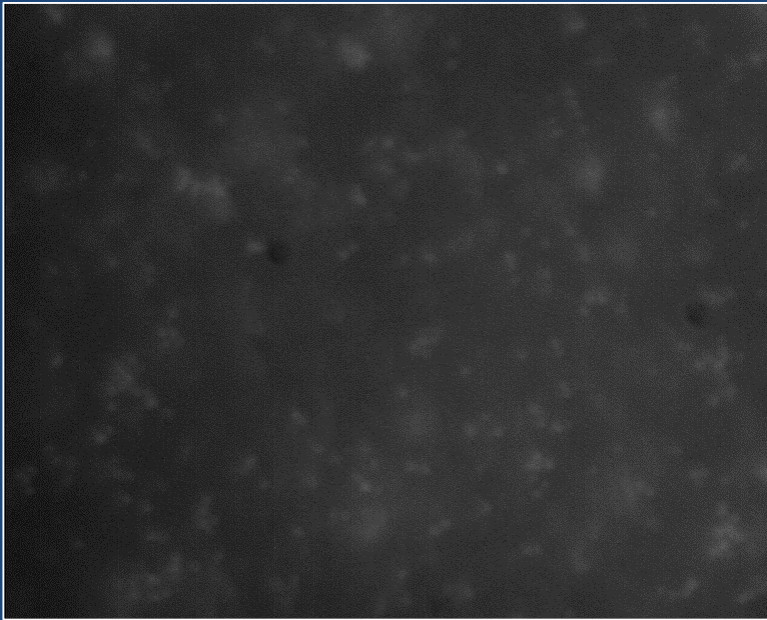

Large particles buzzing  
around

Sample 9 (Small)

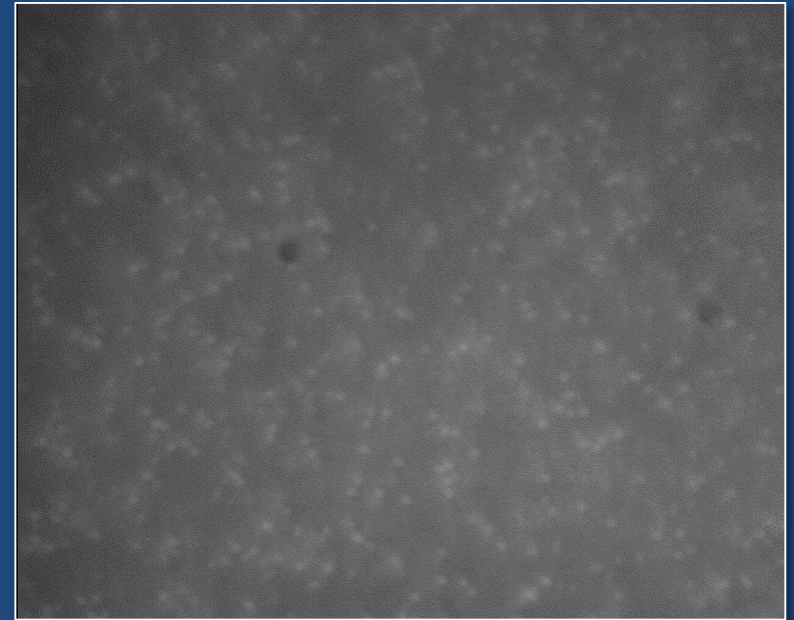

Small particles buzzing  
around

Conc. Polymer (0.8 mg/ml)

# COLLOIDAL PHASE DIAGRAMS OF MONODISPERSED COLLOIDS

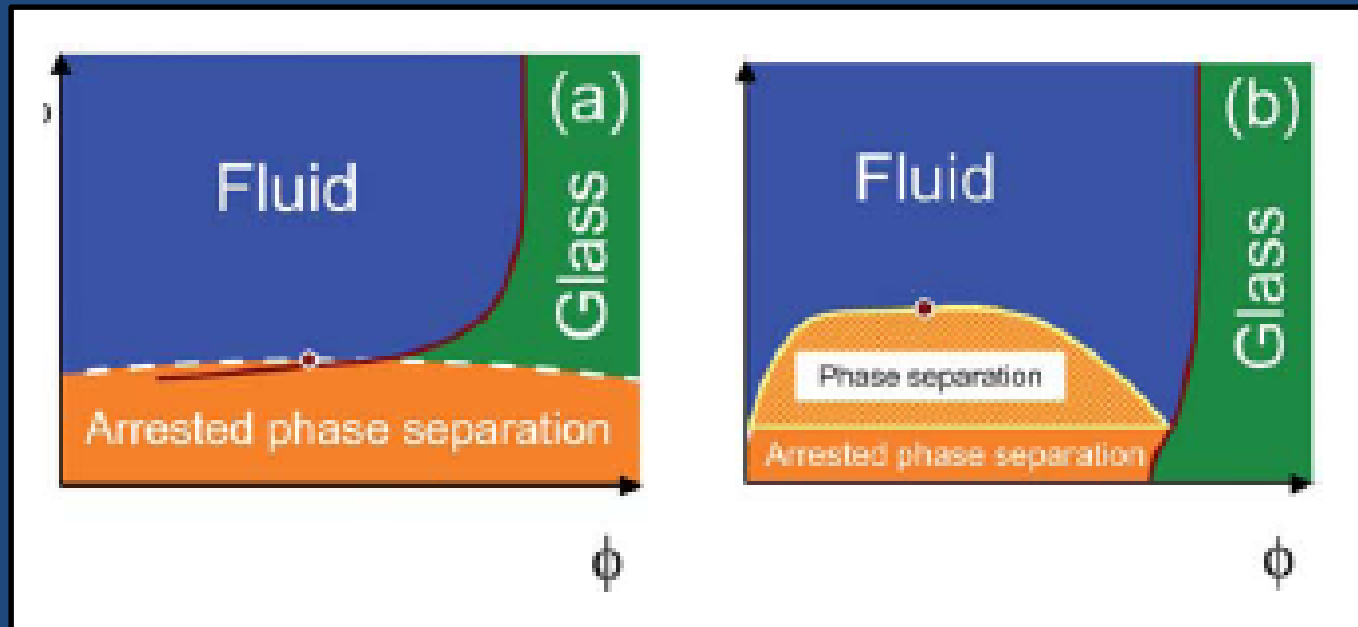

Increasing polymer concentration results in phase separation or arrested phase separation (gel) with monodisperse colloids, depending on the width of the potential

# STRUCTURES- NOT STATIC, FACILITATED BY POLYDISPERSITY

Evolution of Structure

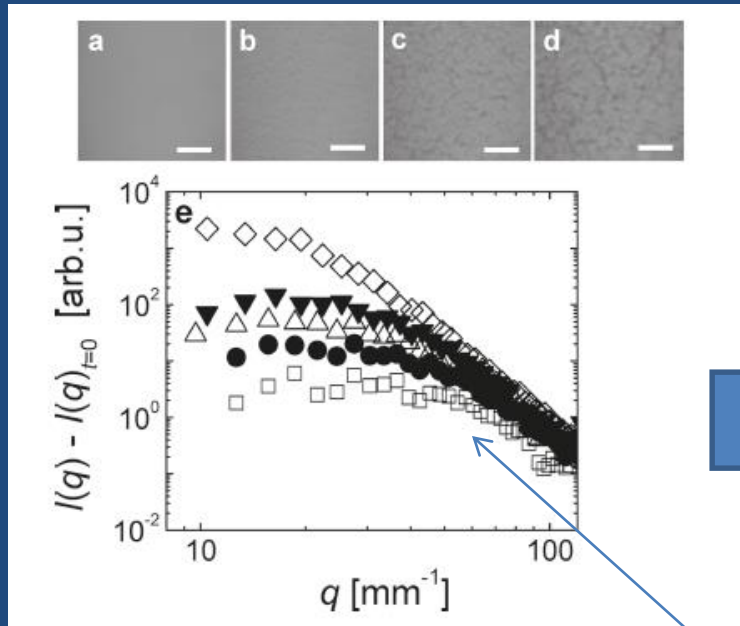

Changes in Sedimentation

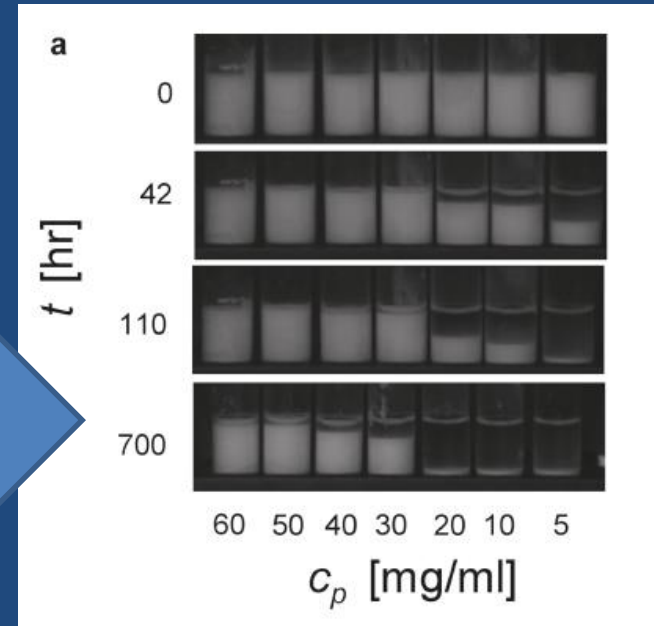

Rates are dramatically changed by polydispersity in the mixtures



Real interest in thinking about how polydispersed systems change over time, to provide predictability.

Weakly aggregated systems – as proxy for ‘real’ system but faster, two sets of dynamics:

- 1- small particles contribute to the development of contrast;
- 2- less clear as to role of small particles in length scale changes.

In the end, expect that changes in properties of the gels is linked to the smaller particles.

LOOKING FORWARD TO NEW CONFOCAL CAPABILITIES

# Investigation goals and objectives (1/2)

- The analysis of the CASIS data suggests that the coarsening changes are somewhat uniform over the range of compositions.

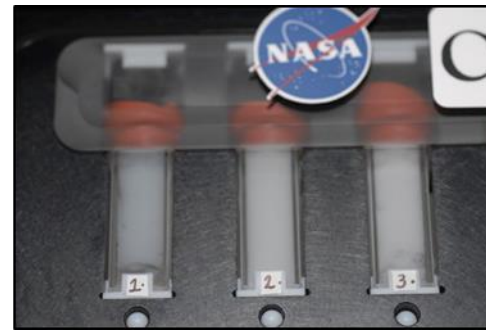

- At the same time, the ACE-M1 data – as challenging as it can be to analysis, look quite different.
- So – the new ACE-T6 confocal microscopy data should help address the uncertainty.

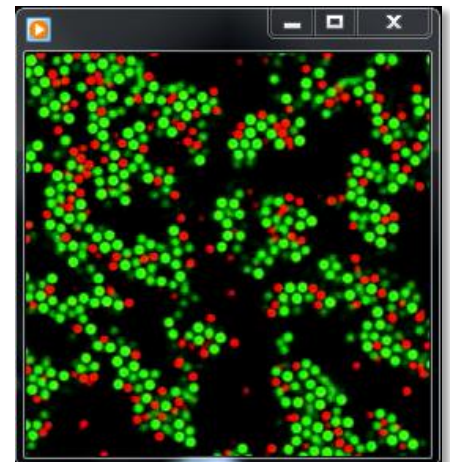

# Investigation goals and objectives (2/2)

## ACE-T6 Measurements / Observables

Three basic measurements/observables that we will probe with these experiments.

(Note, the samples are designed to control the inter-particle forces (through polymer concentration))

- **1. Fundamental rate of coarsening in more complex (binary) dispersion (short-term)** – looking at the movement of small and large colloids coordinated in different sites.
- **2. Initial colloidal structuring in mixed colloidal systems** – looking at the initial structure of the strands that form in the weak gels. Amazing, we discovered on Earth-based measurements that they preferentially order with like colloids size, provide strands of large decorated with small colloids. The implications are huge, in that this implies that stress is only carried by one element of mixtures.
- **3. Particle tracking (long-term)** – for atomistic modeling motions of each kind of colloid, for modeling program.

# Measurement approach – 1/15

We will be using a flight-hardened Commercial-Off-The-Shelf (COTS) Leica DM-RXA microscope with a Yokogawa spinning disk confocal head

[pictured later]

and

ACE-T sample modules

[pictured later]

# Measurement approach – 2/15

## Light Microscopy Module (LMM) in the Fluid Integrated Rack (FIR)

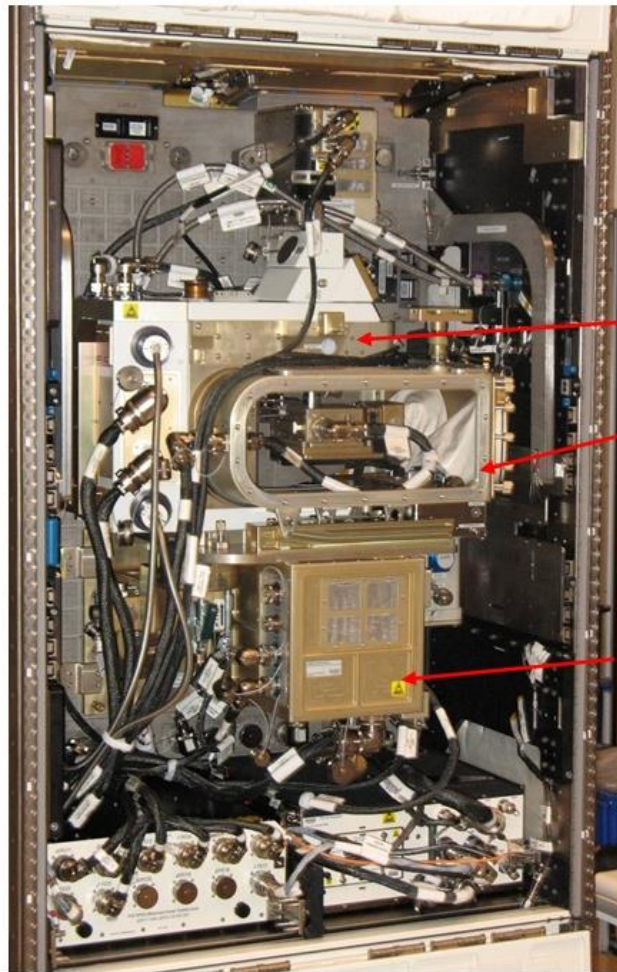

LMM in the Closed Position or Operating Configuration

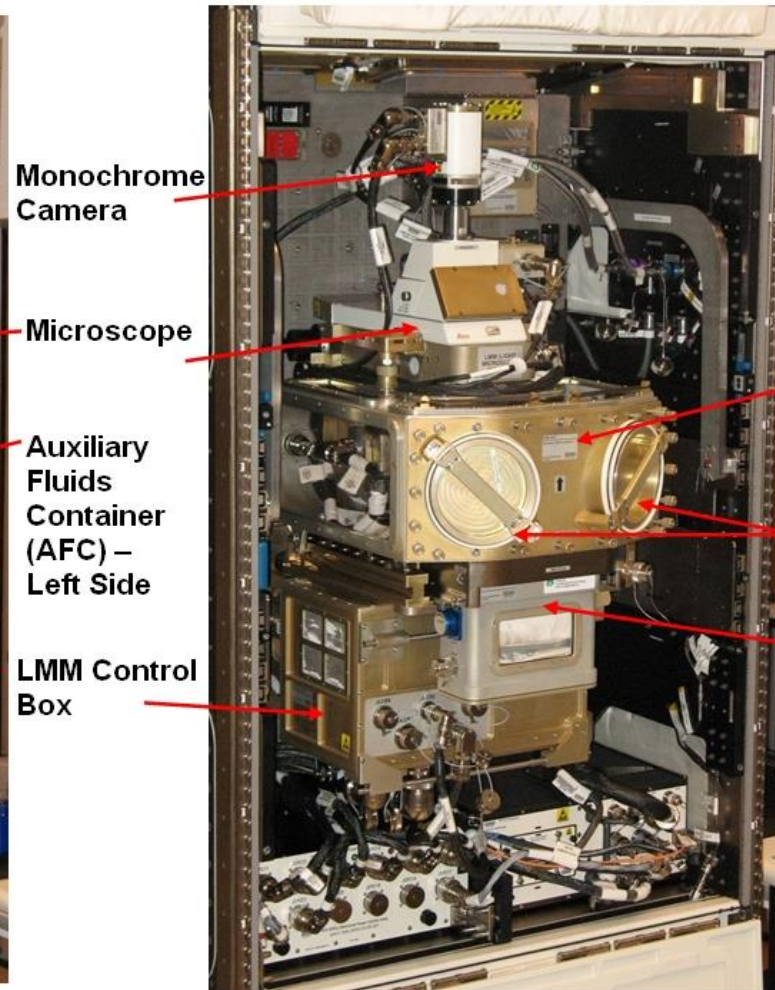

LMM in the Open Position or Installation/Service Configuration

Monochrome Camera

Microscope

Auxiliary Fluids Container (AFC) – Left Side

LMM Control Box

Auxiliary Fluids Container AFC - Front

Glove ports

Equipment Transfer Module (ETM)

# Measurement approach – 3/15

## LMM Implementation Philosophy

Philosophy: Maximize the scientific results by utilizing the existing LMM capabilities. Develop small sample modules and image them within the LMM

Payload specific and multi-user hardware customizes the FIR in a unique laboratory configuration to perform research effectively.

### Light Microscopy Module

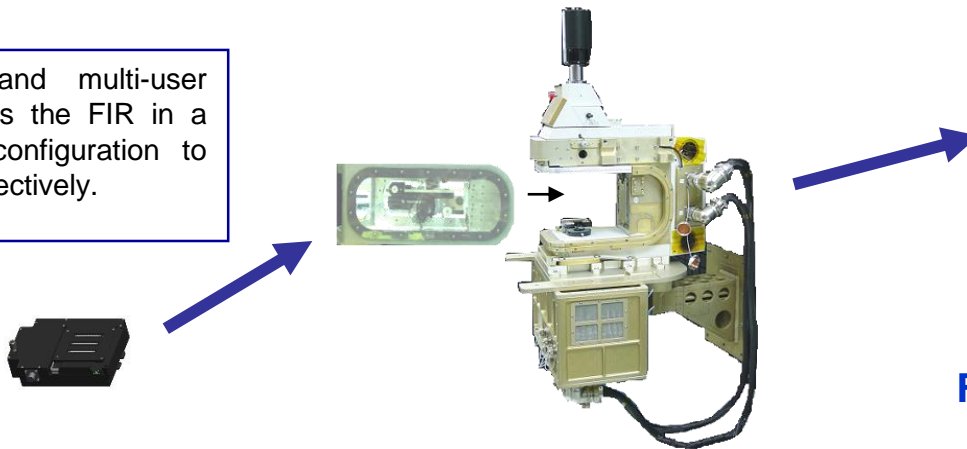

### Payload Specific Hardware

- Sample Cell with universal Sample Tray
- Specific Diagnostics
- Specific Imaging
- Fluid Containment

### Multi-Use Payload Apparatus

- Test Specific Module
- Infrastructure that uniquely meets the needs of PI experiments
- Unique Diagnostics
- Specialized Imaging
- Fluid Containment

### FCF Fluids Integrated Rack

- Power Supply
- Avionics/Control
- Common Illumination
- PI Integration Optics Bench
- Imaging and Frame Capture
- Diagnostics
- Environmental Control
- Data Processing/Storage
- Light Containment
- Active Rack Isolation System (ARIS)

# Measurement approach – 4/15

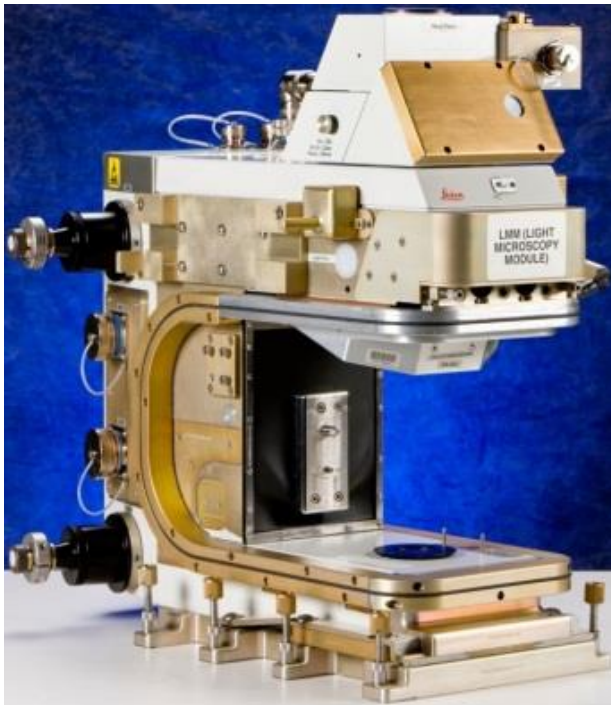

Light Microscopy Module (LMM)

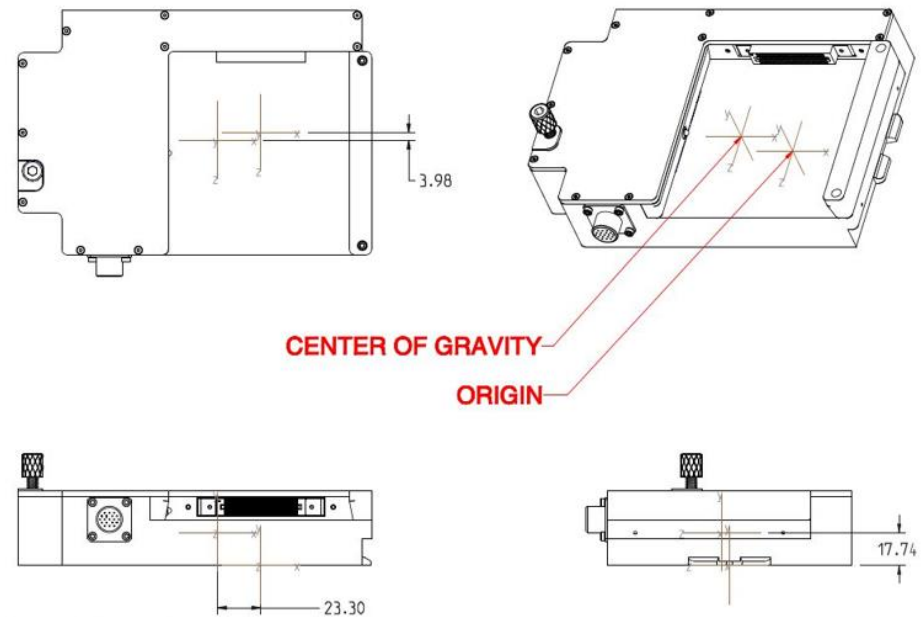
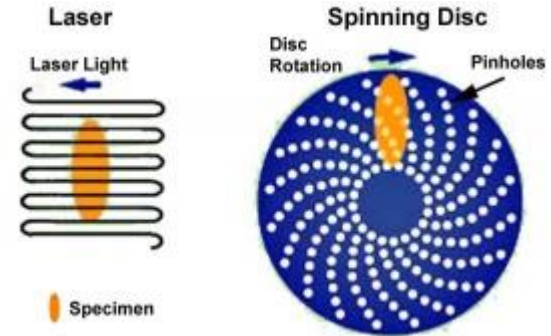
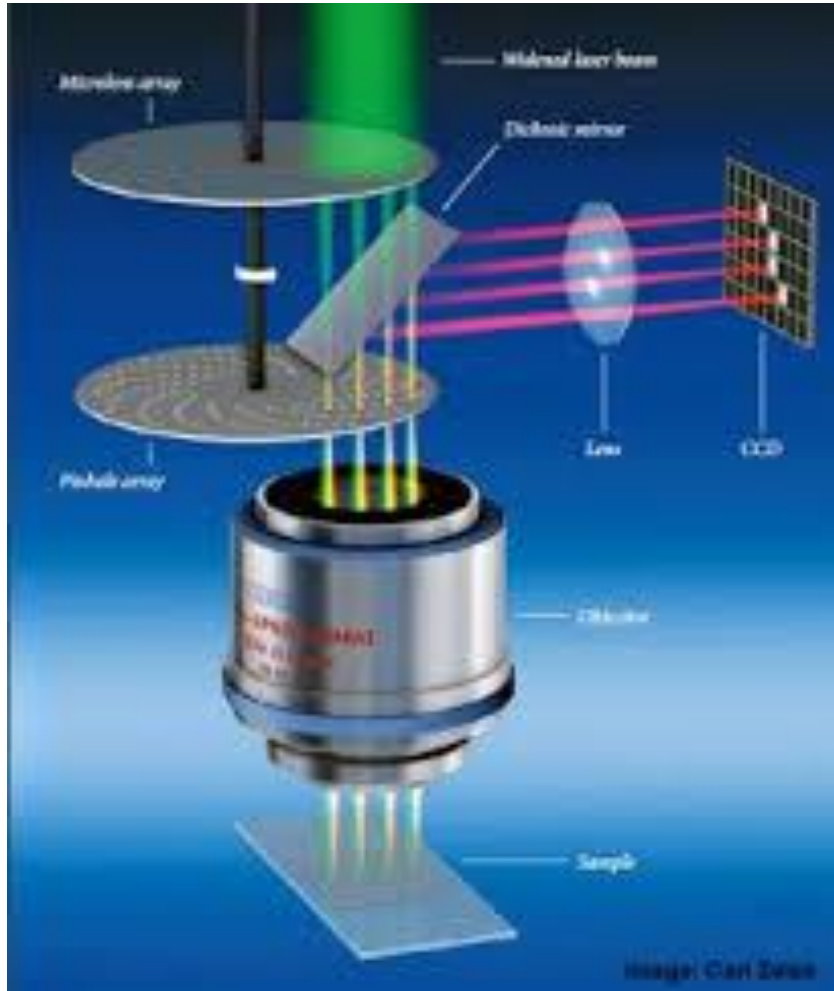

Figure 1: Center of Mass for ACE-T

ACE Sample Assembly with Removable ACE-T Sample Tray that will contain a row of 3 temperature controlled capillary cells



Using confocal microscopy to acquire 3D images.



The difference between traditional and confocal microscopy

*Focus 50 μm below cover slip*

*Traditional microscopy doesn't see through objects well; out-of-focus light obscures in-focus light*



**Particles on top are easily imaged**

*Focus 200 μm below (near bottom of well)*

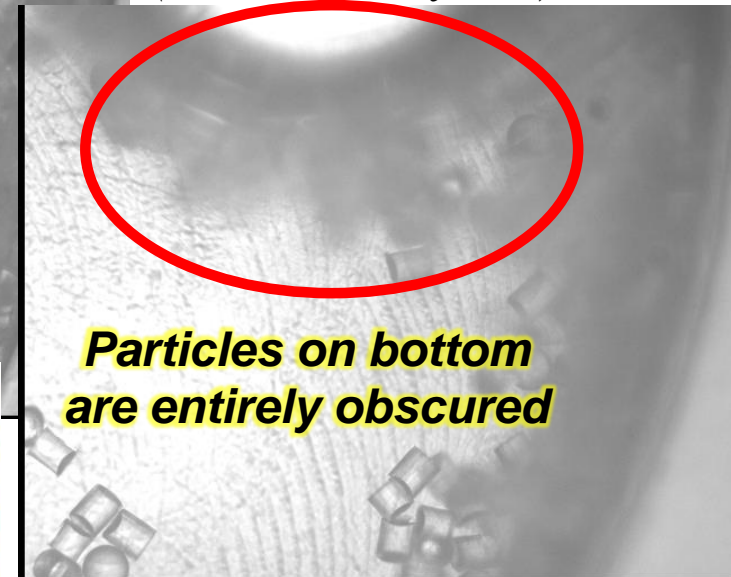

**Particles on bottom are entirely obscured**

*Confocal microscopy rejects out-of-focus light, to look through semi-transparent objects*

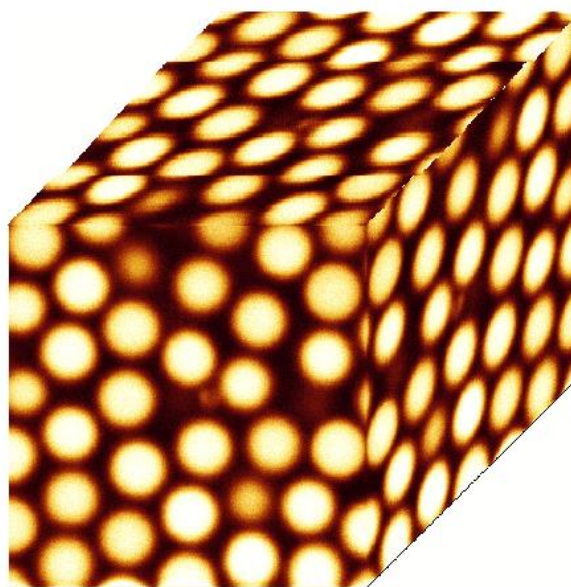

**3D image is built out of 2D XY sections while stepping through Z axis.**

# Measurement approach – 7/15

## Mechanical Design Highlights

- Modular sample assemblies
- Allows for multiple sample configurations.
  - Easier Sample replacement
  - Decreased “ACE-T” up-mass in comparison to ACE-H

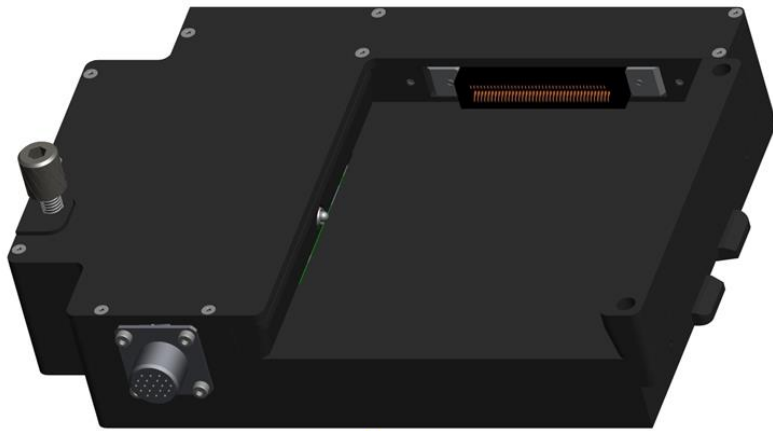

# Measurement approach – 8/15

## Mechanical Design Highlights

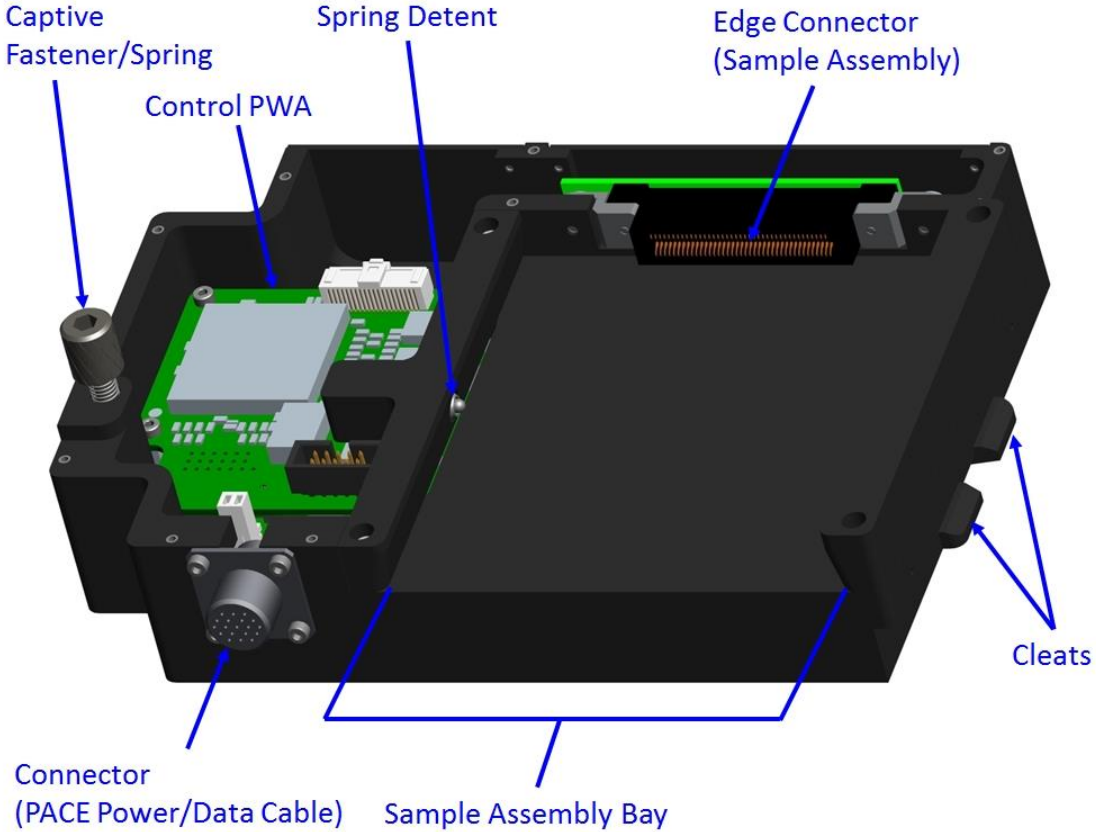

# Measurement approach – 9/15

## Mechanical Design Highlights

- In-situ mixing (details in electrical section)
- Black Hard Anodize Surface Coat
  - Reduction of any errant light within the AFC
  - Increased wear resistance

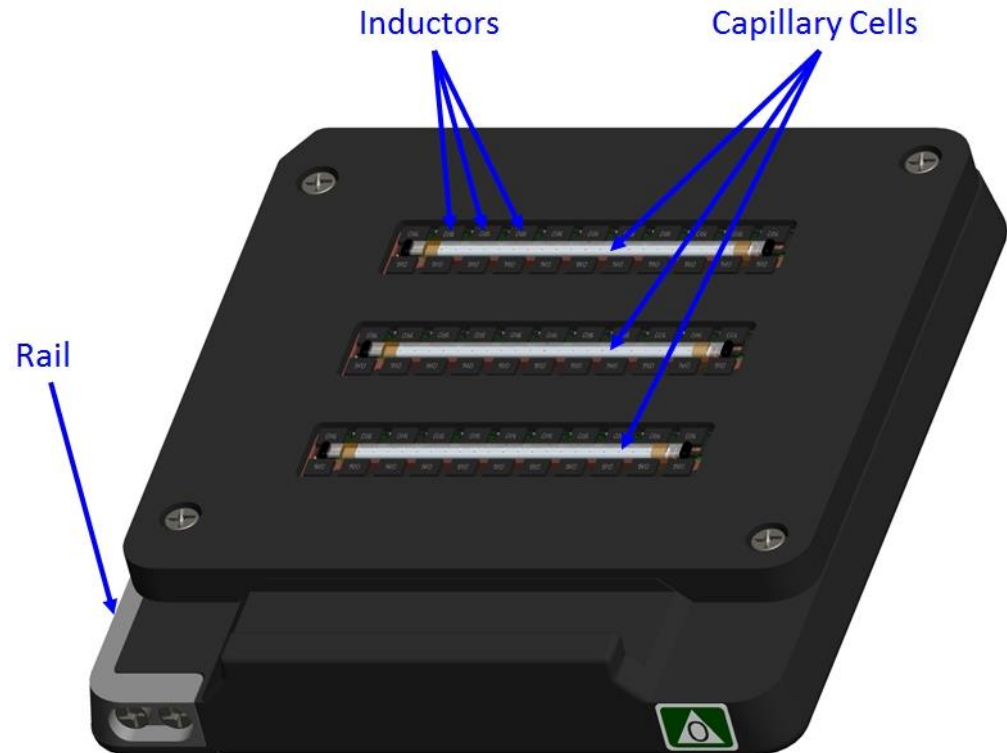

# Measurement approach – 10/15

## Mechanical Design Highlights

### Capillary cell

- Purchased through VitroCom.com
- Material
  - Borosilicate (3520-050)
  - Fused Silica by request (3520S-050)
- COTS
- 50mm length
- Reference Marks
  - Secondary Process to ease positional awareness

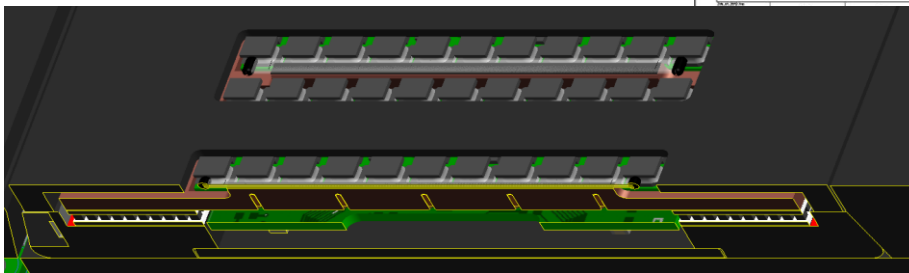
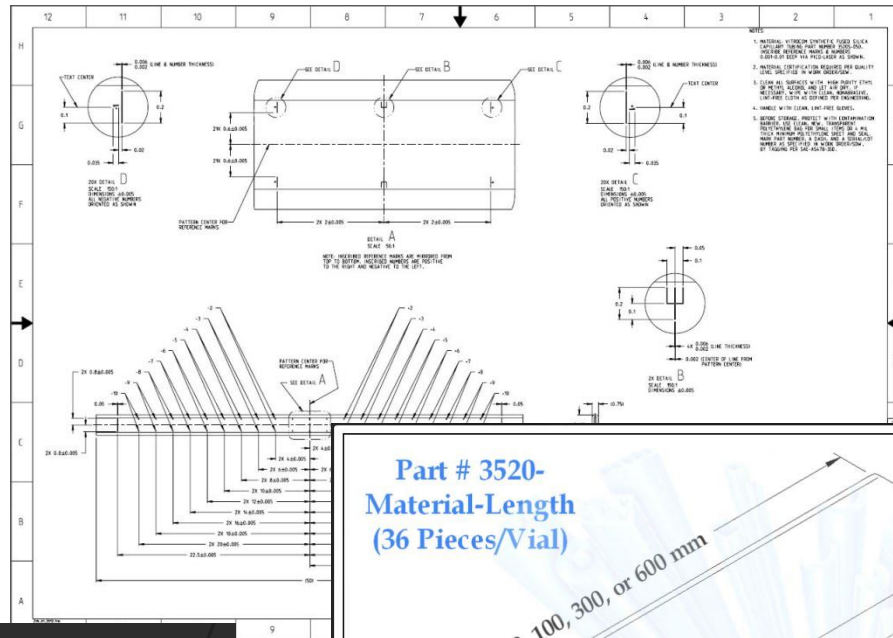

Two capillary cells surrounded by inductors that are used for walking a turning stir-bar for sample mixing.

**Part # 3520-  
Material-Length  
(36 Pieces/Vial)**

TOLERANCES	LENGTH (mm)	
ID +/- 10 %	50 +2 / -0	300 +10 / -0
Wall +/- 20 %	100 +4 / -0	600 +20 / -0

**VITROCOM  
TECHNICAL GLASS**

# Measurement approach – 11/15

## Temperature gradient option

- Thermal bridge
  - Material: Copper
  - Bridges thermal energy between TEM's
  - Constrains Thermistor Positioning
  - Thermal symmetry across X and \*Y Axis

\*When set-points are equal

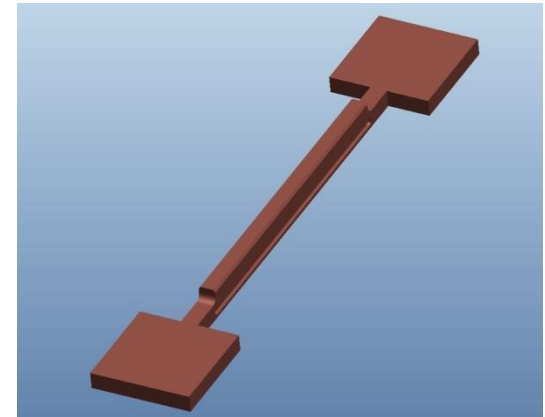
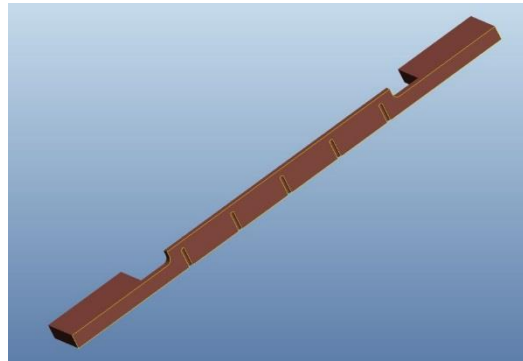

Bonus information: ACE-T, in general, will enable temperature control that can either be linear across the capillary - or a temperature gradient across the capillary. A temperature gradient will form a density gradient! You can now march through a phase diagram using a single capillary and have a common error bar for all measurements.

### Hard Sphere Equilibrium Phase Diagram

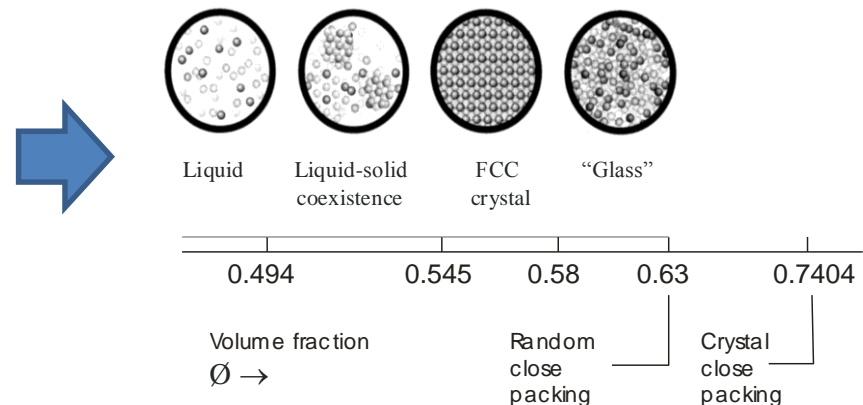

# Measurement approach – 12/15

The experiment consists one control base and two interchangeable samples modules (each sample module contains three capillary cells). The experiments below may be run in any order. Additional details, like which microscope objective to use, are provided in an updated Investigation Summary Form (ISF).

## EQUILIBRIUM EXPERIMENT

Sample 2 – (large/small at 1.1 polymer): mix; find five science spots with PI used for entire experiment; 25 deg. C one set of measurements every 10 hours for 144-hours total (6 days), where measurement for at least 200 um x 200 um x 200 um cube, particle mapping at each science spot with 5 repeats at each 1 minute just for the last spot.

Sample 3 – (large/small at 1.0 polymer): mix; find five science spots with PI used for entire experiment; 25 deg. C one set of measurements every 10 hours for 144-hours total (6 days), where measurement for at least 200 um x 200 um x 200 um cube, particle mapping at each science spot with 5 repeats at each 1 minute just for the last spot.

Sample 4 – (large/small at 0.9 polymer): mix; find five science spots with PI used for entire experiment; 25 deg. C one set of measurements every 10 hours for 144-hours total (6 days), where measurement for at least 200 um x 200 um x 200 um cube, particle mapping at each science spot with 5 repeats at each 1 minute just for the last spot.

Sample 5 – (1.0 polymer, small control): mix; find five science spots with PI used for entire experiment; 25 deg. C one set of measurements every 10 hours for 144-hours total (6 days), where measurement for at least 200 um x 200 um x 200 um cube, particle mapping at each science spot with 5 repeats at each 1 minute just for the last spot.

Sample 6 – (1.0 polymer, large control): mix; find five science spots with PI used for entire experiment; 25 deg. C one set of measurements every 10 hours for 144-hours total (6 days), where measurement for at least 200 um x 200 um x 200 um cube, particle mapping at each science spot with 5 repeats at each 1 minute just for the last spot.

Sample 9 – (1.0 polymer, large, small, very small): mix; find five science spots with PI used for entire experiment; 25 deg. C one set of measurements every 10 hours for 144-hours total (6 days), where measurement for at least 200 um x 200 um x 200 um cube, particle mapping at each science spot with 5 repeats at each 1 minute just for the last spot.

NOTE: the CASIS BCAT KP were 6-10 day experiments.

I'd like to match up in time as much as possible, but will reduce significantly the number of repetitions.

## STRESS EXPERIMENT

Sample 2 – (large/small at 1.1 polymer): mix; find five science spots with PI at 25 deg. C for 24 hours; then 25-35 deg. C temperature gradient measure at least 200 um x 200 um x 200 um cube each 2 hours for 24 hours, with one measure at each science point.

Sample 4 – (large/small at 0.9 polymer): mix; find five science spots with PI at 25 deg. C for 24 hours; then 25-35 deg. C temperature gradient measure at least 200 um x 200 um x 200 um cube each 2 hours for 24 hours, with one measure at each science point.

Sample 5 – Sample 5 – (1.0 polymer, small control): mix; find five science spots with PI at 25 deg. C for 24 hours; then 25-35 deg. C temperature gradient measure at least 200 um x 200 um x 200 um cube each 2 hours for 24 hours, with one measure at each science point.

Sample 6 – (1.0 polymer, large control): mix; find five science spots with PI at 25 deg. C for 24 hours; then 25-35 deg. C temperature gradient measure at least 200 um x 200 um x 200 um cube each 2 hours for 24 hours, with one measure at each science point.

# Measurement approach – 13/15

EQUILIBRIUM SAMPLES (Samples 2, 3, 4, 5, 6 and 9)

1- Mix

2- Select 5 science spots (1-5) for confocal measurements with PI (as soon as possible after mixing).

3-  $t = 0$  hours

Measure 200 x 200 x 200 um science spot 1

Measure 200 x 200 x 200 um science spot 2

Measure 200 x 200 x 200 um science spot 3

Measure 200 x 200 x 200 um science spot 4

Measure 200 x 200 x 200 um science spot 5

Repeat measurement at spot 5 after 1 minute

Repeat measurement at spot 5 after 1 minute

Repeat measurement at spot 5 after 1 minute

Repeat measurement at spot 5 after 1 minute

3-  $t = 10$  hours

Repeat same procedure as  $t = 0$  hours

4-  $t = 20$  hours

Repeat same procedure as  $t = 0$  hours

repeat up to 140 hours (about 6 days)



# Measurement approach – 14/15

STRESSED SAMPLES (Samples 2, 4, 5 and 6)

1- Mix

2- Select 5 science spots (1-5) for confocal measurements with PI (as soon as possible after mixing).

3- at t = 0 hours

Measure 200 x 200 x 200 um science spot 1

Measure 200 x 200 x 200 um science spot 2

Measure 200 x 200 x 200 um science spot 3

Measure 200 x 200 x 200 um science spot 4

Measure 200 x 200 x 200 um science spot 5

Repeat measurement at spot 5 after 1 minute

Repeat measurement at spot 5 after 1 minute

Repeat measurement at spot 5 after 1 minute

Repeat measurement at spot 5 after 1 minute

4- at t = 20 hours

Repeat same procedure as t = 0 hours

5- at t = 20 hours

Low Mag Image

6- at t = 20 hours (after 4 is complete)

Set temperature gradient 25 – 35 C (10 degrees)

# Measurement approach – 15/15

## STRESSED SAMPLES

7- at t = 22 hours

Measure 200 x 200 x 200 um science spot 1

Measure 200 x 200 x 200 um science spot 2

Measure 200 x 200 x 200 um science spot 3

Measure 200 x 200 x 200 um science spot 4

Measure 200 x 200 x 200 um science spot 5

Repeat measurement at spot 5 after 1 minute

Repeat measurement at spot 5 after 1 minute

Repeat measurement at spot 5 after 1 minute

Repeat measurement at spot 5 after 1 minute

8- at t = 24 hours

Repeat same procedure as t = 22 hours

repeat up to t = 44 hours

9- at t = 44 hours

Low Mag image

# Importance and reason for ISS

- Colloidal stability is critical to soft matter systems, as it relates to products;
- These products are often structured by attractive forces between constituent particles (solids, vesicles, drops)- in the form of weak, flowable colloidal gels;
- These structures change in time, by processes known as coarsening - meaning the particles move under thermal motion to compact. This compaction continually changes this structure;
- When the structures created in the products can no longer support the **gravitational stresses** (e.g. buoyancy) on the structures, they collapse. The collapse is often abrupt and without warning (delayed collapse). This is **the essence of product instability**;
- For Procter and the broad scientific community, there is a large disconnect between microscopic structure and dynamics of these mixtures to the macroscopic changes in the structure which lead to collapse. Understanding this relationship may enable us to anticipate instability in products; directly relating to multi-million dollar products and initiatives.

# Expected results and how they will advance the field (1/2)

This research will have significant impact in two areas:

- First, in the scientific community, there is a large disconnect between microscopic structure and dynamics of these mixtures to the macroscopic changes in the structure which lead to collapse. This work will significantly enhance the knowledge necessary to advance this important area of science.
- Second, understanding this relationship should enable us to anticipate instability in products, directly impacting the development of multi-billion dollar products and initiatives which improve the lives of 4.8 billion people on Earth per day from products originating from Procter & Gamble alone.

# Expected results and how they will advance the field (2/2)

Real interest in thinking about how polydispersed systems change over time, to provide predictability.

Weakly aggregated systems – as proxy for ‘real’ system but faster, two sets of dynamics:

- 1- small particles contribute to the development of contrast;
- 2- less clear as to role of small particles in length scale changes.

In the end, expect that changes in properties of the gels is linked to the smaller particles.

LOOKING FORWARD TO NEW CONFOCAL CAPABILITIES



# Earth benefits/spin-off applications (1/2)



For Procter & Gamble (P&G):

- Product shelf-life extended
- Product quality enhanced
- Production cost lowered (stabilizers are expensive)
- Transportation cost reduced (by concentrating essence)

Dispersed 1-micron spheres in water

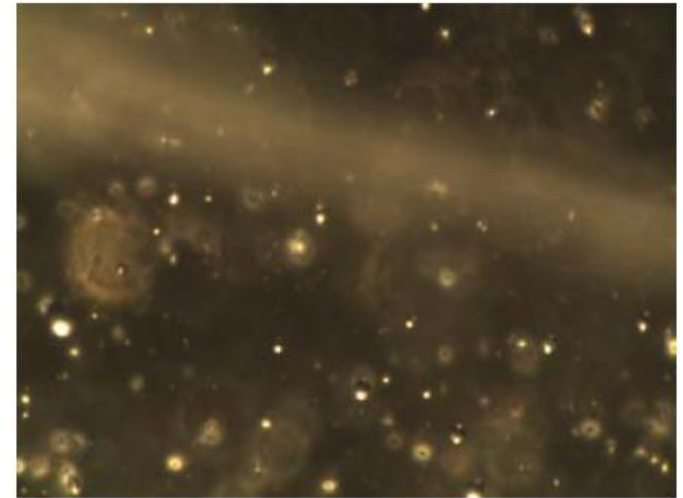

P&G spent 2 plus years with LANL and UCSB with high-powered computers to model this behavior ... no luck!

Why this work with colloids is important: we have

- Weakly-attractive systems - phase separation
- Strongly-attractive systems - gelation or crystallization
- Frontiers of soft-squishy colloids (soft - very cool)

Dr. Matthew Lynch  
Principal Scientist  
Corporate Research Division  
Procter & Gamble Company



## Earth benefits/spin-off applications (2/2)



Understanding the behavior of mixtures and coarsening can help materials scientists to make colloidal mixtures with longer shelf lives. This has great potentials in creating a wide range of products from food, medicine, cosmetics, gels, and cleaning solutions which do not expire quickly.

“P&G products improve the lives of 4.8 billion people every day, which is more than  $\frac{1}{2}$  of the planet’s population... aim to reach them all...”



# ACE-T6

## Increment 53/54 Science Symposium

**BACKUP SLIDES**

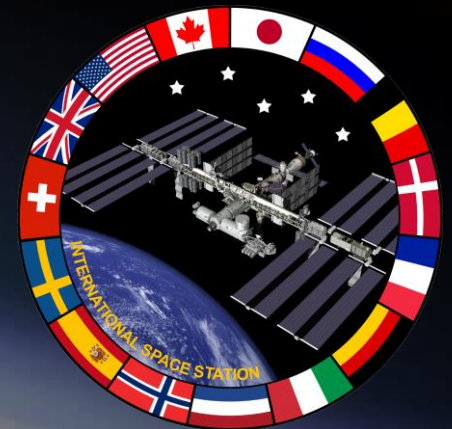





## ACE-T6 samples, 1/2

Well #	Capillary Cell Contents
<b>1</b> Particle Media Depletant Conc. <b>[Optional]</b>	Composition: 2.5 % large (2.0 micron) latex particles 2.5 % small (1.7 micron) latex particles 95.0 % solvent (27% sulfolane / 73% formamide) 10 mM NaCl 1.3 mg/ml 1 MDa polystyrene
<b>2</b> Particle Media Depletant Conc.	Composition: 2.5 % large (2.0 micron) latex particles 2.5 % small (1.7 micron) latex particles 95.0 % solvent (27% sulfolane / 73% formamide) 10 mM NaCl 1.1 mg/ml 1 MDa polystyrene
<b>3</b> Particle Media Depletant Conc.	Composition: 2.5 % large (2.0 micron) latex particles 2.5 % small (1.7 micron) latex particles 95.0 % solvent (27% sulfolane / 73% formamide) 10 mM NaCl 1.0 mg/ml 1 MDa polystyrene
<b>4</b> Particle Media Depletant Conc.	Composition: 2.5 % large (2.0 micron) latex particles 2.5 % small (1.7 micron) latex particles 95.0 % solvent (27% sulfolane / 73% formamide) 10 mM NaCl 0.9 mg/ml 1 MDa polystyrene
<b>5</b> Particle Media Depletant Conc.	Composition: 5.0 % small (1.7 micron) latex particles 95.0 % solvent (27% sulfolane / 73% formamide) 10 mM NaCl 1.0 mg/ml 1 MDa polystyrene

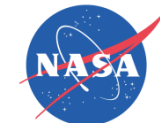

## ACE-T6 samples, 2/2

Well #	Capillary Cell Contents
6 Particle Media Depletant Conc.	Composition: 5.0 % large (2.0 micron) latex particles 95.0 % solvent (27% sulfolane / 73% formamide) 10 mM NaCl 1.0 mg/ml 1 MDa polystyrene
7 Particle Media Depletant Conc. [Optional]	Composition: 2.5 % small (1.7 micron) latex particles 2.5 % tiny (1.45 micron) latex particles 95.0 % solvent (27% sulfolane / 73% formamide) 10 mM NaCl 1.0 mg/ml 1 MDa polystyrene
8 Particle Media Depletant Conc. [Optional]	Composition: 2.5 % small (1.7 micron) latex particles 2.5 % tiny (1.45 micron) latex particles 95.0 % solvent (27% sulfolane / 73% formamide) 10 mM NaCl 1.1 mg/ml 1 MDa polystyrene
9 Particle Media Depletant Conc.	Composition: 1.7 % large (2.0 micron) latex particles 1.7 % small (1.7 micron) latex particles 1.7 % tiny (1.45 micron) latex particles 95.0 % solvent (27% sulfolane / 73% formamide) 10 mM NaCl 1.0 mg/ml 1 MDa polystyrene



# ACE-T6 Success Criteria



Complete success is the achievement of all of the science requirements. This means that there will be sufficient information to provide a crosscheck of all data and calculated factors. Processing, manipulation and characterization of the samples in micro-gravity are as important as the measurements during the experiments themselves. e.g., sample homogenization is essential to conduct of any of the flight experiments. This allows for the homogenization of the crystallites or any structures formed from phase separation or gelation that have occurred in 1g before launch, and provides a proper starting point in micro-g.

Success Level	Accomplishment
Minimum Success	<ul style="list-style-type: none"><li>• Homogenize completely at least 40% of the complete set of samples, and observe the time evolution with confocal microscopy imaging for several days to weeks, depending on rates of change determined in real-time as data is downlinked to earth (these cannot be predicted accurately ahead of time in the 1g environment, as we have seen with the BCAT and ACE-M1 samples)</li><li>• Have sufficient data (both in terms of frequency and duration) from microscopy of sufficient quality to observe, characterize and quantify the rates of growth of structures formed as a result of the physical process of interest in microgravity, including but not limited to crystallization, phase separation and gelation. The behavior cannot be predicted ahead of time, and as we have seen in BCAT and ACE-M1, often new mechanisms can be observed whose presence is masked on earth by the presence of gravity.</li><li>• We hope that these processes will generate new structures formed in microgravity, that may direct further earthbound studies and inspire new directions for materials synthesis and fundamental physics understanding.</li></ul>
Significant Success	<ul style="list-style-type: none"><li>• Accomplish the above for 50% of the different types fluid samples launched.</li></ul>
Complete Success	<ul style="list-style-type: none"><li>• Accomplish the above for all launched samples, with multiple runs to repeat the experiment and assess reproducibility.</li></ul>

# ACE-T6 sample tests with confocal

Matt Lynch, Bill Meyer, Chris Lant

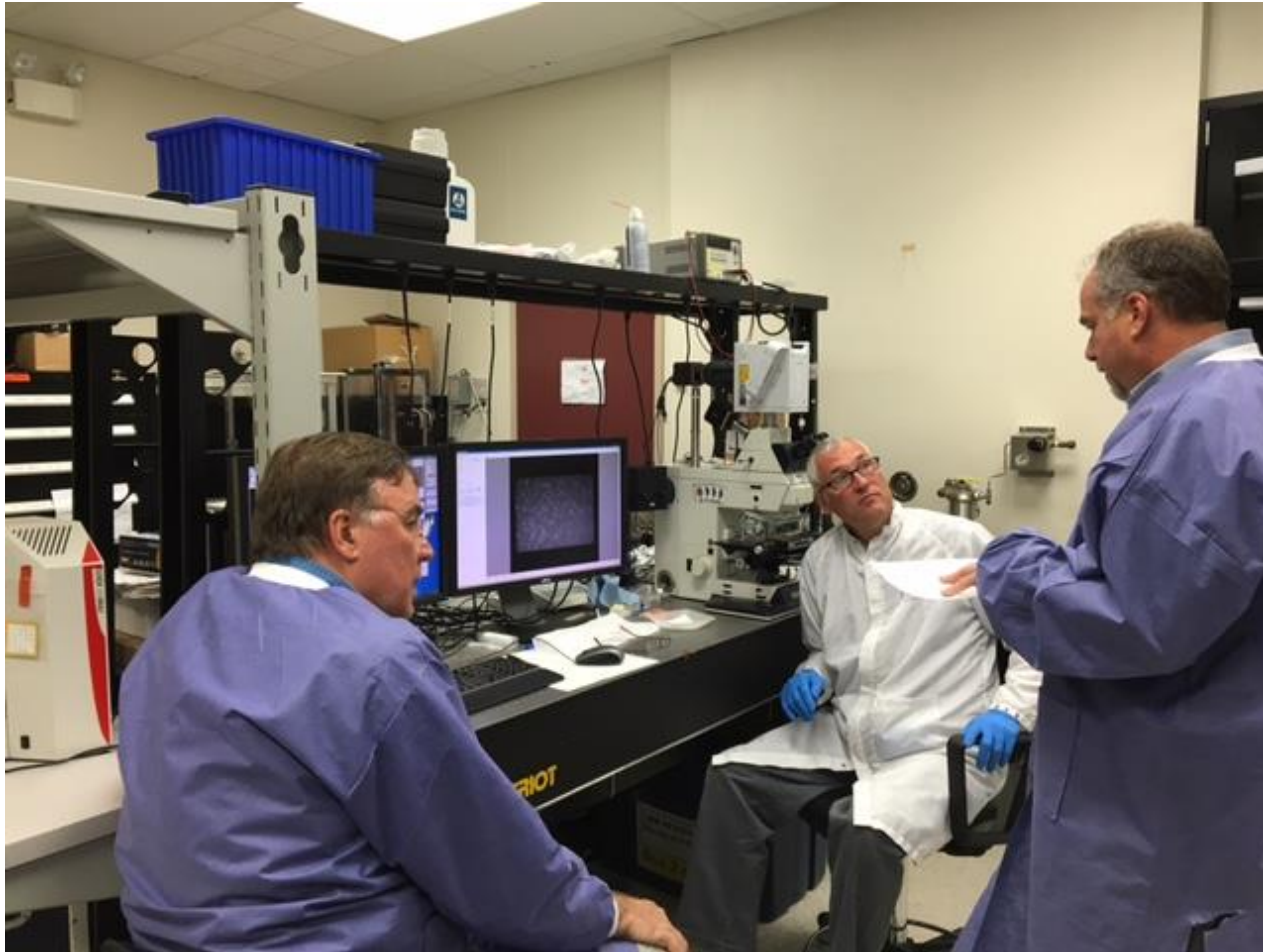

Testing a new generation of samples for the Advanced Colloids Experiment (ACE-T6) experiment with a ground-based version of the confocal microscope that will be used on the International Space Station (ISS).



# Microgravity Justification

- Formation of colloidal structures is profoundly affected by gravity via sedimentation processes. Chaikin and Russel have already demonstrated this effect in space experiments exploring the simplest of all entropic transitions, the hard-sphere liquid-solid phase transition.
- Sedimentation causes particles to fall so rapidly that there is insufficient time for particles to explore the full phase space of positions and velocities that are required for thermodynamic assembly processes. A substantial particle concentration gradient arises in the earthbound sample.

$$h = \frac{kT}{\Delta\rho V g}$$

$h$  = gravitational height

$kT$  = Thermal Energy of system

$\Delta\rho$  is the density difference between the particles and the background fluid

$V$  is the particle volume

$g$  is the gravitational acceleration

$h$  ranges from a few microns for the case of polystyrene in water to a fraction of a micron for most of the other particles we consider. Our particles are usually of order 1 micron in diameter.



# Microgravity Justification

(continued)

- In addition, the shear forces of fluid flow due to the sedimenting particles is often sufficient to break structures that are forming thermodynamically.
- The solvents we plan to use (such as water) are restricted by various factors, for example by our need to fix the colloidal structures in space. Almost all of the particles of future interest are either too heavy or too light compared to water.
- Sample equilibration often requires ~1 to 12 hours. Structure growth sometimes continues for one to two more weeks after the initiation process. These processes are too slow for a drop tower or an airplane.
- Space station or space shuttle provides an environment where microgravity is sustained long enough to allow these experiments to be conducted. The samples can be homogenized, and then allowed to develop in the microgravity environment. Their structures and optical properties can be measured. For most samples we are contemplating, the density mismatch between particle and background fluid is large (e.g.  $> 1.1 \times$ ). Microgravity dramatically reduces these differences and permits true equilibrium processes to occur.