

NON-INTRUSIVE VELOCITY MEASUREMENTS WITH MTV DURING DCC EVENT IN THE HTTF

M. A. André and P. M. Bardet

Department of Mechanical Engineering
The George Washington University
Washington, DC 20052, USA
matandre@gwu.edu; bardet@gwu.edu

S. R. Cadell and B. Woods

Department of Nuclear Engineering
Oregon State University
Corvallis, OR 97331, USA
seth.cadell@oregonstate.edu; woods@engr.orst.edu

R. A. Burns

National Institute of Aerospace
Hampton, VA 23666, USA
ross.a.burns@nasa.gov

P. M. Danehy

NASA Langley Research Center
Hampton, VA 23681, USA
paul.m.danehy@nasa.gov

ABSTRACT

Velocity profiles are measured using molecular tagging velocimetry (MTV) in the high temperature test facility (HTTF) at Oregon State University during a depressurized conduction cooldown (DCC) event. The HTTF is a quarter scale electrically heated nuclear reactor simulator designed to replicate various accident scenarios. During a DCC, a double ended guillotine break results in the reactor pressure vessel (RPV) depressurizing into the reactor cavity and ultimately leading to air ingress in the reactor core (lock-exchange and gas diffusion). It is critical to understand the resulting buoyancy-driven flow to characterize the reactor self-cooling capacity through natural circulation.

During tests conducted at ambient pressure and temperature, the RPV containing helium is opened (via the hot and cold legs) to a large vessel filled with nitrogen to simulate the atmosphere. The velocity profile on the hot leg pipe centerline is recorded at 10 Hz with MTV based on NO tracers. The precision of the velocimetry was measured to be 0.02 m/s in quiescent flow prior to the tests. A helium flow from the RPV is initially observed in the top quarter of the pipe. During the first 20 seconds of the event, helium flows out of the RPV with a maximum velocity below 2 m/s. The velocity profile transitions from parabolic to linear in character and decays slowly over the rest of the recording; peak velocities of 0.2 m/s are observed after 30 min. A counter-flow of nitrogen is also observed intermittently, which occurs at lower velocities (>0.1 m/s).

MTV was implemented here for the first time in a large-scale thermal hydraulic facility and holds promise both for gaining fundamental understanding of such flows and as a validation tools for numerical simulations. The flow patterns and timescales observed indicate that additional flow regimes might be taking place between the predicted lock-exchange and diffusion regimes.

KEYWORDS

Molecular tagging velocimetry, gas cooled reactor, validation data, buoyancy-driven flow

1. INTRODUCTION

Very High Temperature gas cooled Reactor (VHTR) have the potential to be efficient, economical, and safe source of carbon-free electricity. The high temperatures present in the reactor core also allow the reactors to serve as source of high-quality heat, which can have a multitude of industrial applications. This design is being considered as part of the Generation IV nuclear reactors and is the main reactor under study in the US under the Next Generation Nuclear Plant (NGNP) design. To assist in the development of the NGNP, several integral-effect and separate-effect test facilities (IET and SET) have recently been built in the United States [1,2]. These research programs aim at developing correlations and benchmark cases for system-level codes as well as for validating computational fluid dynamics (CFD) codes. The requirements for the latter are more extensive than for the former. Specifically, in addition to measuring point-wise temperature and pressure drops necessary for low-order models, it is desirable to resolve velocity and temperature fields in the fluid as well. Acquiring such data requires a different class of diagnostic than is used for developing correlations. For some situations, laser-based diagnostics would be appropriate for resolving the desired quantities. However, their deployment in a large IET is rather challenging, which has limited their use to date.

In the present study, a molecular tagging velocimetry (MTV) system was developed and deployed in-situ in an IET of a VHTR. The facility and accident scenario under study are presented first. Then the experimental measurement system and its in-situ deployment is introduced. Velocity results for several runs in the IET are finally reported.

2. INTEGRAL EFFECT TEST FACILITY

2.1. High Temperature Test Facility

To assist in development of system level codes as well as validation of CFD codes, an integral-effect test facility has been built at Oregon State University under sponsorships of the US Department of Energy and the US Nuclear Regulatory Commission: The High-Temperature Test Facility (HTTF). The HTTF is an electrically heated scaled down model of a VHTR, based on General Atomics' Modular High-Temperature Gas-cooled Reactor (MHTGR) design. This facility was designed for the simulation of depressurized conduction cooldown (DCC) accident scenario. It can also be employed for Pressurized Conduction Cooldown (PCC) tests. The facility is $\frac{1}{4}$ -height (6.1 m tall), $\frac{1}{4}$ -diameter (1.92 m OD) model of the MHTGR and in its current configuration has a prismatic block core. It is a reduced pressure (1:8 ratio or 8 atm) and prototypical temperature ($\sim 700^{\circ}\text{C}$) facility.

In a DCC event, the pressure boundary has been ruptured through a double-ended guillotine break of the inlet and outlet cross-over ducts, which are concentric pipes with the hot leg enclosed in the cold leg. At the end of the rapid depressurization, air from the cavity in which the reactor vessel and auxiliary system sit ingresses in the reactor pressure vessel (RPV). The air ingress through the break will lead to oxidation of the graphite in the RPV and in some conditions, could lead to loss of mechanical integrity of the core and the release of fission products in an actual reactor.

In the HTTF, artificial pipe break and air ingress are simulated with the hot and cold legs discharging from the RPV inside a Reactor Cavity Simulation Tank (RCST). The RCST can be filled with gas mixtures prior to opening pneumatically controlled ball valves that sit in each leg. Figure 1 presents the RPV with the initially annular cross over duct that splits into two separate pipes that independently enter the RCST.

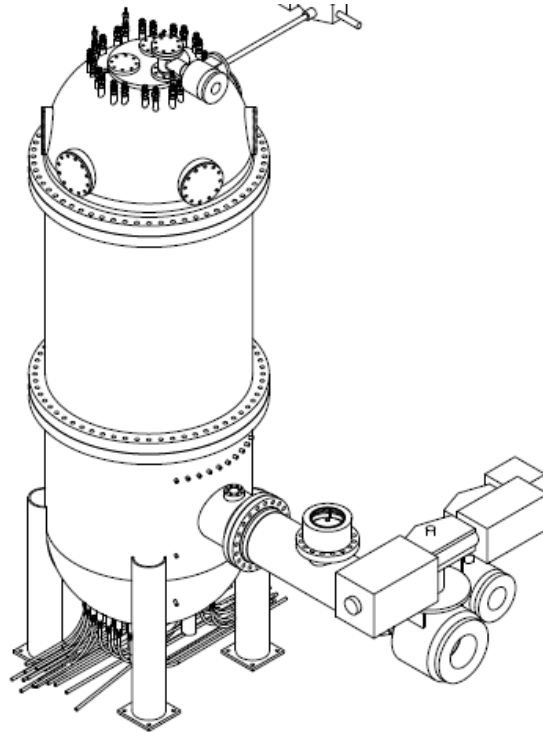

Figure 1. Schematic of reactor pressure vessel. The hot and cold legs are shown at the bottom right, the hot leg being the larger diameter pipe that goes straight inside the RCST. Elements on top of the legs are pneumatic actuators for the valve valves that simulate the double-ended cross-over duct break

2.2. DCC event description

Air ingress events have been the subject of numerous analytical and numerical studies to, in part, inform design of the HTTF. From these studies, it is assumed that an air ingress event follows several stages [1] that are summarized here along with the main equations relating the main observable quantities. After the depressurization of the RPV, a stratified counter-flow takes place within the hot and cold legs between the RPV and RCST, resulting in air entering the lower plenum of the RPV, stage 1. In a second stage, air within the lower plenum is circulated within the hot core by natural convection. In this work, data have only been only acquired with core at room temperature, and a more in-depth description of the first stage is given to facilitate interpretation of the data.

Following the work of Oh and Kim, 2011 [3], during the first stage two air ingress mechanisms have been identified: stratified flow and diffusion. In the stratified flow, or gravity current, mechanism the density difference between the helium on the inside, and the air on the outside (or in the RCST in the HTTF) drives a counter flow through the break. The diffusion mechanism is driven by air concentration gradients between the inside and the outside. The time scales of each mechanism are defined as:

$$\Delta t_{gc} = \frac{L_1}{U_s} \quad (1)$$

$$\Delta t_d = \frac{L_2^2}{D_{AB}} \quad (2)$$

where L_1 and L_2 are the length-scales associated with gravity currents and diffusion, respectively, U_s the axial velocity scale or the superficial velocity, and D_{AB} the bimolecular diffusivity coefficient of He into air. The gravity current length-scale, L_1 , is taken as the distance from the break to the center of the lower plenum. The superficial velocity is related to the current speed U by:

$$U_s = U \frac{h}{H} \quad (3)$$

where H and h are the channel and current depths. The current velocity for the density ratio, γ , of interest is given by:

$$U = \sqrt{(1 - \gamma)gH} \sqrt{\frac{1}{\gamma} \frac{h}{H} \left(2 - \frac{h}{H}\right) \frac{1 - h/H}{1 + h/H}} \quad (4)$$

where g is the acceleration of gravity. For two non-reacting non-polar gases, the bimolecular diffusivity coefficient is given by:

$$D_{AB} = \frac{18.58T^{3/2}}{P\sigma_{AB}^2\Omega_D} \left(\frac{1}{M_A} + \frac{1}{M_B}\right) \quad (5)$$

Where T is the temperature, P the pressure, M the molecular weight, σ_{AB} Lennard-Jones parameter, and Ω_D the collision integral. The diffusion length scale varies with time and is calculated by solving the following equation:

$$\frac{1}{D_{LP}} \int_{LP} \left[1 - \operatorname{erf}\left(\frac{z}{2\sqrt{D_{AB}t}}\right)\right] dz = 0.5 \quad (6)$$

where D_{LP} is the lower plenum diameter and erf is the error function. For the MHTGR conditions, Oh and Kim 2011 computed the following values for the gravity current and diffusion timescales. $\Delta t_{gc} = 19.5$ s and $\Delta t_d = 1.29 \times 10^4$ s. The relative magnitude of these time scales indicate that diffusion should be negligible in this stage of the DCC event.

3. DIAGNOSTICS

3.1. MTV technique summary

Molecular tagging velocimetry (MTV) is a time-of-flight velocity measurement technique that relies on locally creating and tracking molecular tracers [4]. A first laser pulse (or write pulse) creates the tracers with a predetermined spatial pattern, and then a second laser pulse (read pulse) or pulses excite a cross-section of the flow with a controlled time interval. The location of the displaced tracers is recorded for each read pulse with a camera, ultimately leading to velocity profiles. The technique was first developed in the lab using NO tracers obtained from photo-dissociation of N_2O [5]. Velocity profiles were successfully obtained in air, nitrogen, and helium for a large range of parameters: temperature from 295 to 781 K, pressure from 1 to 3 bars, with a velocity precision of 0.01 m/s in the laboratory and 0.02 m/s in-situ. Details of the MTV technique and its applicability to VHTR studies are presented in a companion paper and presentation [6].

3.2. Deployment to the HTTF

The MTV technique was optimized in the lab for the expected conditions of the HTTF, which included the timing parameters, laser excitation wavelength, and optimal tracer concentration. The optical path was adjusted to match the geometry of the HTTF. The laser system was developed on a cart to allow easy transportation.

Another challenging aspect of the instrumentation was to enable remote control of the measurement system, which includes remote adjustment of the power and timing parameters of several lasers, control of the laser, camera, and dye temperatures, and the remote monitoring and steering of the laser beams to maintain overlap in the test region. Such control was accomplished with computer-controlled linear translation stages and data acquisition system, remote connected computers to control the lasers, and CCTV camera system. The layout of the experiment at OSU is shown in Figure 2.

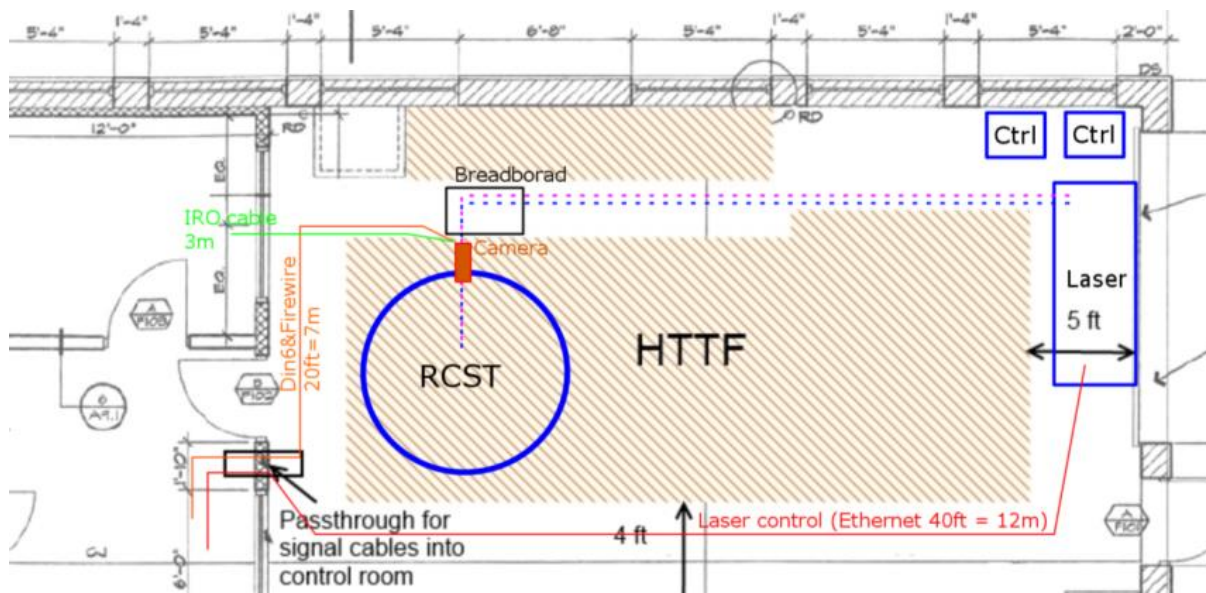

Figure 2. Floor plan of the HTTF showing laser and camera location

Details of the laser cart are shown in figure 3:



Figure 3. Laser cart. Left: back of the cart. Right: Front of the cart with the two beams being shot through the tubes.

Details of the breadboard holding the optics and camera section are shown in figure 4:

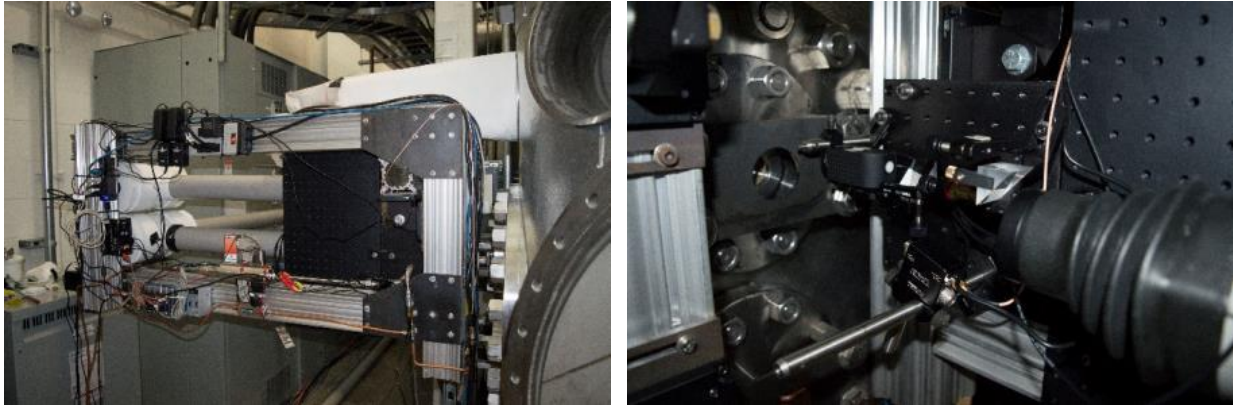

Figure 4. Left: Frame supporting the instrumentation on the RSCT. Right: Key final focusing elements just before the viewport into the test section.

Once inside the RCST, the beams are redirected towards the exit of the hot leg with a 90° prism, visible on the left image of figure 5. The beams are aligned to overlap in the measurement region, highlighted in purple. Figure 5, right, gives the exact coordinates of the velocity measurements location at the exit of the hot leg. The beam was carefully aligned to be vertical and intersect the pipe centerline.

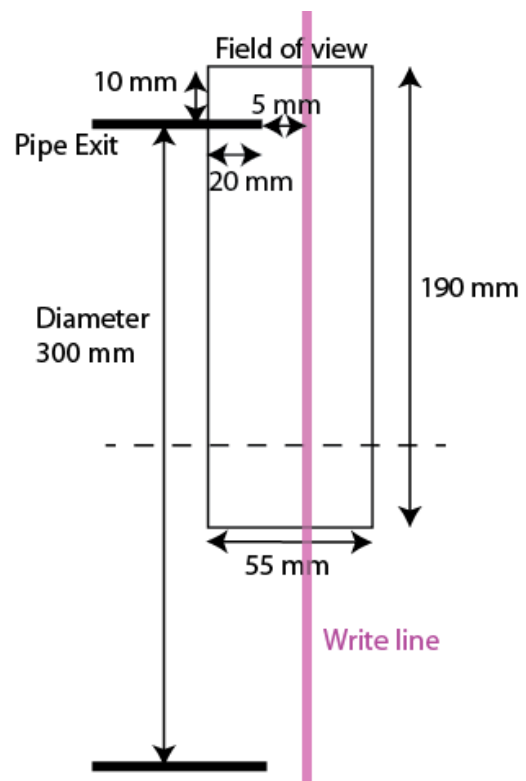
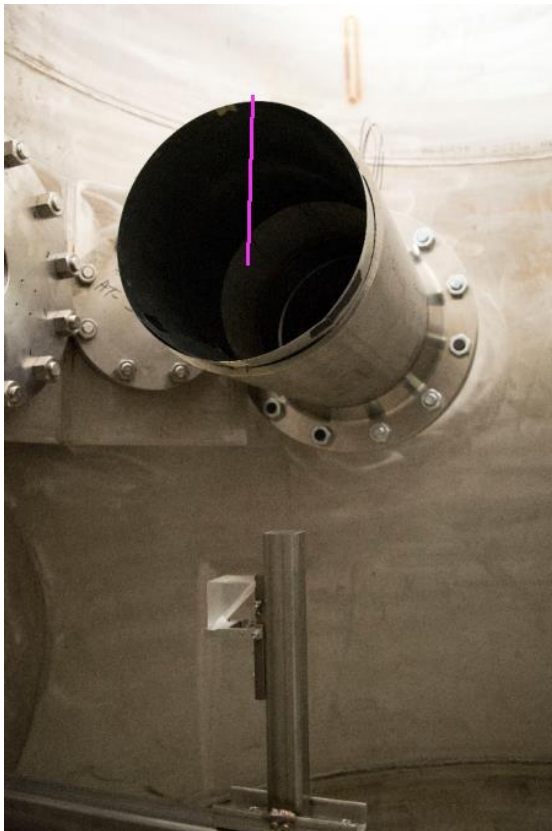

Figure 5. Left: Photo of the inside of the RCST showing the hot leg and final turning prism. Right: Measurement region near the exit of the hot leg pipe. The purple indicates the location of the tracers in both images.

4. RESULTS

4.1. Isothermal DCC, hot leg break only

In this test, gases are at ambient temperature, and only the hot leg valve is opened. This was the first test of the diagnostics in the HTTF as well as operation of the latter in these conditions. As a result, there was large uncertainty on the gas concentration in the vessels. It was estimated (with $\pm 5\%$ uncertainty) that the RPV had 70% He 30% N₂ and RCST had 80% N₂ and 20% He, for a density ratio $\gamma = 0.48$. At $t = 0$ s, the valve starts to open, and is fully opened at $t = 14$ s. Data are recorded up to $t = 1,800$ s, or 30 min.

4.1.1. Short-term behavior

Figure 6 shows velocity profiles and time evolution of the velocity for the first 120 seconds to focus on the early stage of this lock exchange.

The qualitative description of the flow obtained from looking at the raw MTV images is clearly seen in the spatial profiles, and the magnitude of the velocity can now be quantified. The peak velocities are approximately 0.95 m/s for the helium flow out of the RPV, and -0.20 m/s for the nitrogen into the RPV, as shown on the left of figure 6. Helium flow occupies the top quarter of the pipe and nitrogen flow the rest. The corresponding current velocity calculated using equation (4) is 0.9 m/s, in agreement with the measured value.

The magnitude of the flow velocities then decreased as time progressed. This time evolution is better visualized in figure 6, right, where temporal evolution for a few selected points is plotted. The flow starts about $t = 10$ s into the run due to the slow opening of the valve. The purple and orange curves are near the inflection point (where He and N₂ mix) and show more fluctuations than in the initially pure helium stream (top curve) or in the N₂ stream (bottom 2 curves). This region of mixing is characterized by large velocity gradients and an inflection point in the velocity profile, which can give rise to flow instability, most likely of the Kelvin-Helmholtz type. These instabilities are visible in figure 6, right, as rapid temporal variations in the velocity traces.

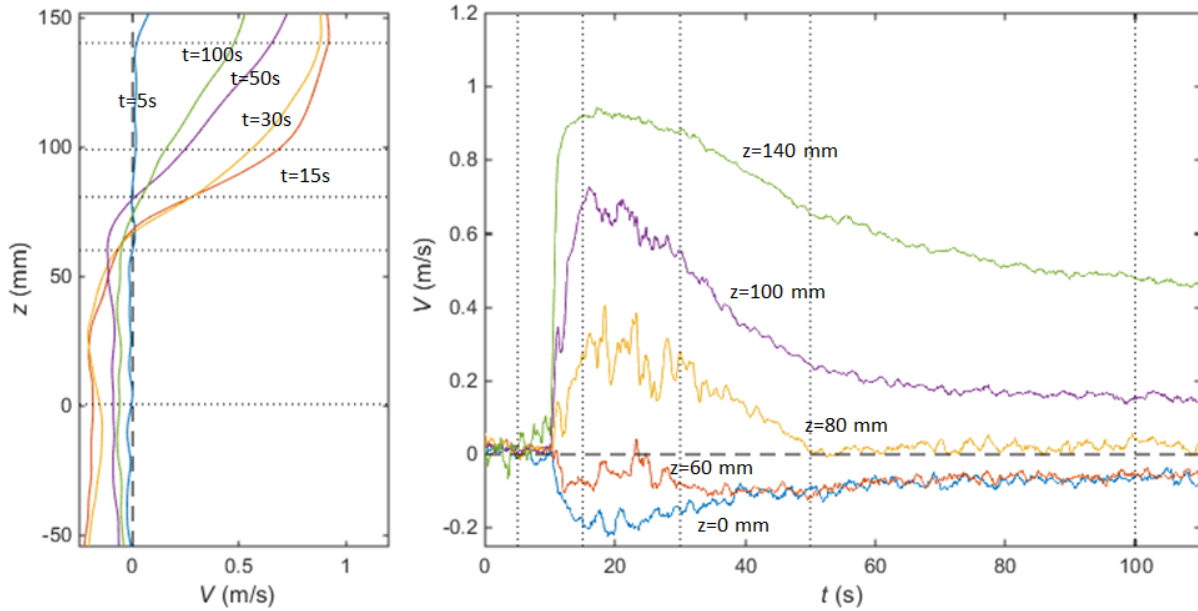

Figure 6. Velocity results for isothermal hot leg only DCC, zoomed in the early stage. Left figure shows velocity versus location (spatial profiles) at the instants marked by a dotted line on the right figure. The right figure shows velocity versus time (temporal profiles) at the location indicated by dotted lines on the left figure

4.1.2. Long-term behavior

Figure 7 shows the late stage of the flow for the same run. The discontinuity around $t = 550$ s and $t = 1,100$ s are artifacts resulting from the change of dt , which allowed probing slower speeds more accurately. As shown in these curves, the velocity profiles maintain the same trends as was observed in the short-term behavior: the velocities also continue to decrease in magnitude. Unlike predictions by numerical simulations, which predicted that no flow should be present after 30-60 s [7], there is still a significant flow for a long period after the valve opened (~ 0.2 m/s after 30 min). The difference can be attributed to assumptions made and models used when simulating the flow in the HTTF.

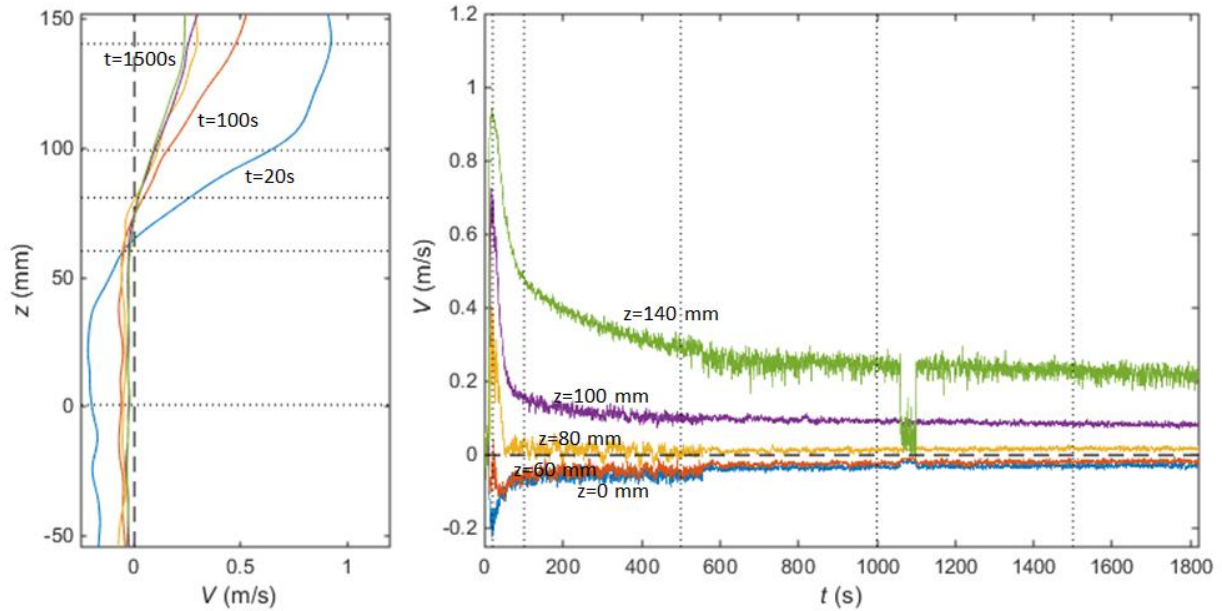

Figure 7. Same as figure 6, for the full run showing the late stage flow

4.3. Isothermal DCC, hot leg + cold leg break

The setup of this test was similar, and the gas content was estimated at 100% He in the RPV and 70% N₂ 30% He in the RCST for a density ratio $\gamma = 0.19$. Uncertainties on the concentration in now on the order of 1%. Both hot and cold legs were opened at the beginning of the run to simulate a realistic DCC break. The camera was pointed slightly upward and raised to fully capture the He flow at the top of the pipe. This portion of the flow was previously unresolved partly because of image vignetting near the edges of the frame.

Figure 8 shows the observed flow from this test. The jump at $t = 500$ s is also an artifact due to the change of dt . It has some similarity with the previous hot leg only DCC, but also exhibits differences. Notably, the maximum velocity is higher at around 2.1 m/s, which is explained by the higher helium concentration in the RPV as the calculated current velocity is 1.8 m/s.

Another interesting phenomenon is the increase of velocity around $t = 150$ s. This feature was not observed in the previous test when only the hot leg was opened. It could also be due to the different gas composition. Balance of the flow between the hot and cold legs could create a feedback loop that increases the hot leg flow for a short duration. Work to understand this phenomenon is still ongoing. At $t = 600$ s (10 min), hot and cold legs were closed, which is visible on the graph: Velocities drop to zero after that event.

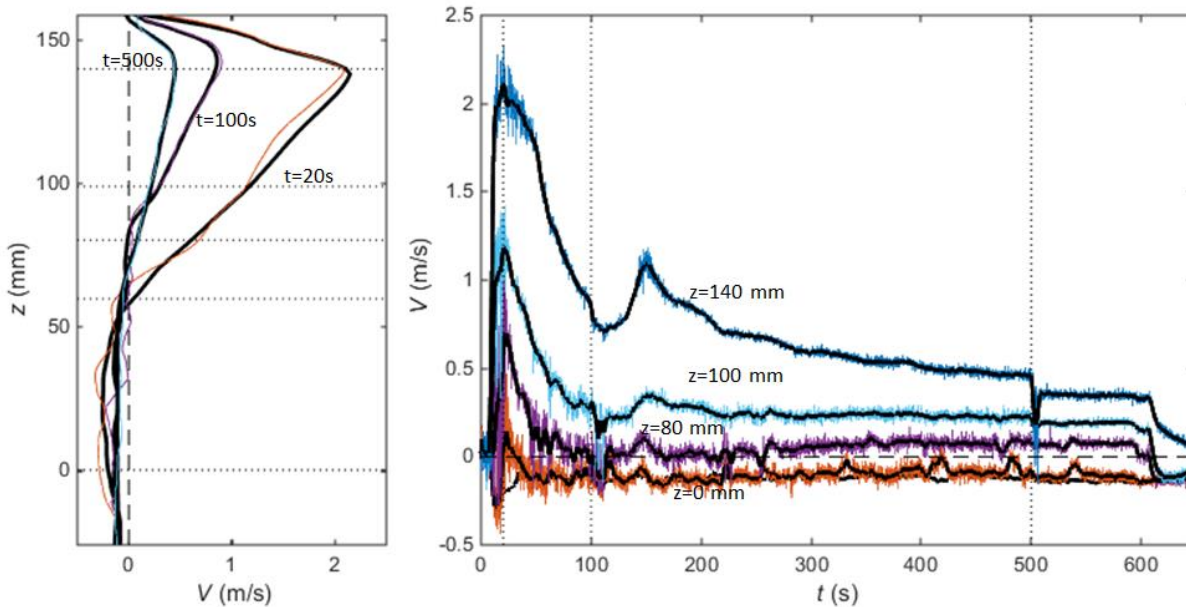

Figure 8. Velocity result for isothermal DCC. Thick black lines are locally averaged profiles

5. CONCLUSIONS

Velocity profiles have been successfully measured using molecular tagging velocimetry (MTV) in the high temperature test facility (HTTF) at Oregon State University during a depressurized conduction cooldown (DCC) event. The technique was developed in the lab then deployed at OSU. The challenges associated with implementing an advanced optical technique to an IET have been overcome and valuable results were obtained.

During an isothermal DCC event where only the hot leg was opened, a helium flow from the RPV is initially observed in the top quarter of the pipe. During the first 20 seconds of the event, the velocity profile seems parabolic with a maximum current velocity of 0.9 and 1.7 m/s, depending on the initial RPV gas composition, in agreement with the theory. The velocity profile then becomes linear and decays slowly over the rest of the recording (down to 0.2 m/s after 30 min). A counter-flow of nitrogen is also observed intermittently at lower velocity (0.1 to 0.02 m/s). A separate experiment in which both the hot and cold legs of the HTTF were opened, the flow behaved similarly but exhibited higher velocities. Two interesting features were observed and would deserve more scrutiny: -the persistence of a significant flow past several minutes, and -a temporary increase of the current velocity after about 2 minutes into the DCC with both legs of the HTTF open.

In summary, MTV was implemented here for the first time in a large scale nuclear facility and shows a very promising potential for both gaining fundamental understanding of such flows and as a validation tools for numerical simulations. The flow patterns and timescales observed indicate that an additional flow regimes might be taking place between the predicted lock-exchange and diffusion regimes.

ACKNOWLEDGMENTS

This project was supported by a DOE NEUP grant to Dr. Bardet.

REFERENCES

1. JN Reyes, JT Groome, BG Woods, B Jackson, and TD Marshall. "Scaling analysis for the high temperature Gas Reactor Test Section (GRTS)", Nuclear Engineering and Design, 240:397-404, 2010.
2. RR Schultz, PD Bayless, RW Johnson, GE McCreery, W Taitano, JR Wolf. "Studies related to the Oregon State University High Temperature Test Facility: scaling, the validation matrix, and similarities to the Modular High Temperature Gas-Cooled Reactor", INL/EXT-10-19803, 2010.
3. CH Oh, and SK Eung. "Air-ingress analysis: Part 1. Theoretical approach." Nuclear Engineering and Design 241:203-212, 2011.
4. Springer Handbook of Experimental Fluid Mechanics, ed. Topea, Yaris, Foss, ch. B.5.4.
5. AM ElBaz and RW Pitz. N₂O molecular tagging velocimetry. Applied Physics B, 106(4):961-969, 2012.
6. MA Andre, PM Bardet, SR Cadell, B Woods, RA Burns, PM Danehy. "Development of a molecular tagging velocimetry technique for non-intrusive velocity measurements in low-speed gas flows", Proceedings of NURETH 17.
7. CH Oh, and SK Eung. "Air-ingress analysis: Part 2. Computational fluid dynamic models." Nuclear Engineering and Design 241:213-225, 2011.