

# 2014 ISS Potable Water Characterization and Continuation of the Dimethylsilanediol Chronicle

John E. Straub II<sup>1</sup> and Debrah K. Plumlee<sup>2</sup>

*Wyle Science, Technology and Engineering Group, Houston, Texas, 77058*

*and*

Paul D. Mudgett<sup>3</sup>

*NASA Johnson Space Center, Houston, Texas, 77058*

During 2014 the crews from Expeditions 38-41 were in residence on the International Space Station (ISS). In addition to the U.S. potable water reclaimed from humidity condensate and urine, the other water supplies available for their use were Russian potable water reclaimed from condensate and Russian ground-supplied potable water. Beginning in June of 2014 and for the fourth time since 2010, the product water from the U.S. water processor assembly (WPA) experienced a rise in the total organic carbon (TOC) level due to organic contaminants breaking through the water treatment process. Results from ground analyses of ISS archival water samples returned on Soyuz 38 confirmed that dimethylsilanediol was once again the contaminant responsible for the rise. With this confirmation in hand and based upon the low toxicity of dimethylsilanediol, a waiver was approved to allow the crew to continue to consume the water after the TOC level exceeded the U.S. Segment limit of 3 mg/L. Several weeks after the WPA multifiltration beds were replaced, the TOC levels returned to below the method detection limit of the onboard TOC analyzer (TOCA) as anticipated based upon experience from previous rises. This paper presents and discusses the chemical analysis results for the ISS archival potable-water samples returned in 2014 and analyzed by the Johnson Space Center's Toxicology and Environmental Chemistry laboratory. These results showed compliance with ISS potable water quality standards and indicated that the potable-water supplies were acceptable for crew consumption. Although dimethylsilanediol levels were at times elevated, they remained well below the 35 mg/L health limit so the continued consumption of the U.S. potable water was considered a low risk to crew health and safety. Excellent agreement between in-flight and archival sample TOC data confirmed that the TOCA performed optimally and continued to serve as a vital tool for monitoring organic breakthrough and planning remediation action.

## Nomenclature

BKO	Russian Multifiltration Beds
CatRx	Catalytic Reactor
CE	Capillary Electrophoresis
CWC	Contingency Water Container
CWC-I	Contingency Water Container - Iodine
DAI	Direct Aqueous Injection
EDV	Russian Portable Water Tank (22 liters)
EPA	Environmental Protection Agency
GC/MS	Gas Chromatography/Mass Spectrometry
IC	Ion Chromatography
ICP/MS	Inductively Coupled Plasma/Mass Spectrometry
ISS	International Space Station
IX	Ion Exchange
JSC	Johnson Space Center

<sup>1</sup> Senior Engineer, Wyle Science, Technology and Engineering Group, Mail Stop: Wyle/HEF/37A.

<sup>2</sup> Senior Scientist, Wyle Science, Technology and Engineering Group, Mail Stop: Wyle/HEF/37A.

<sup>3</sup> Environmental Chemistry Technical Monitor, NASA Johnson Space Center, Mail Stop: SK4.

KSC	Kennedy Space Center
LC	Liquid Chromatography
LC/MS	Liquid Chromatography/Mass Spectrometry
LCV	Leuco Crystal Violet
MCL	Maximum Contaminant Level
MF	Multifiltration
MORD	Medical Operations Requirements Document
N/A	Not Applicable
NA	Not Analyzed
NASA	National Aeronautics and Space Administration
NTU	Nephelometric Turbidity Unit
PFU	Protoflight unit
PWD	Potable-Water Dispenser
RIP	Rack Interface Panel
R&R	Remove and Replace
SM	Service Module
SRV-K	System for Regeneration of Condensate Water
SVO-ZV	System for Water Storage and Dispensing
SWEG	Spacecraft Water Exposure Guideline
TEC	Toxicology and Environmental Chemistry
THM	Trihalomethanes
TOCA	Total Organic Carbon Analyzer
U.S.	United States
UV	Ultraviolet
WPA	Water Processor Assembly

## I. Introduction

This paper presents and discusses the analytical results for chemical characterization of the International Space Station (ISS) archival-water samples returned during 2014 from Expeditions 38-41, as detailed in Table 1. Analytical data for archival-water samples returned during Expeditions 1-37 have been previously reported<sup>1-12</sup>.

Water samples returned on Soyuz 38-41 were unstowed at the landing site in Kazakhstan and turned over to a NASA representative for transportation to the United States (U.S.) on a NASA aircraft with the returning U.S. crewmembers. The returned samples were received upon arrival at Ellington Field in Houston, Texas by a representative of the NASA Johnson Space Center (JSC) Toxicology and Environmental Chemistry (TEC) laboratory and delivered directly to the laboratory for processing and analysis.

Allocation for the various chemical analyses was performed in the TEC laboratory based upon the volume of the ISS return-water samples. Full chemical characterization was performed using the standard and custom analytical methods identified in Table 2 whenever the sample volume was  $\geq 500$  mL. Individual sample volumes of less than 500 mL required reductions in allocated volumes and/or elimination of some analyses, resulting in reduced sensitivity of some analyses performed. Portions of the return-water samples were shared with the JSC Microbiology Laboratory and those microbial analysis results were separately reported elsewhere.

Analytical results for the Russian Segment and U.S. Segment water samples were evaluated for compliance with the potable-water quality requirements found in the *ISS Medical Operations Requirement Document (MORD)*<sup>13</sup> and the *System Specification for the ISS* document<sup>14</sup>, respectively.

Expedition	Flight No.	Samples Received	Sample Type	Sample Collection Date	Sample Receipt Date
38	Soyuz 36	1	PWD Ambient	2/3/2014	3/12/2014
		1	PWD Hot	2/24/2014	
		1	SRV-K Hot	2/24/2014	
		1	SVO-ZV	2/24/2014	
	<b>Total:</b>	<b>4</b>			
39	Soyuz 37	1	PWD Ambient	3/31/2014	5/15/2014
		1	PWD Hot	5/6/2014	
	<b>Total:</b>	<b>2</b>			
40	Soyuz 38	1	PWD Ambient	8/6/2014	9/11/2014
		1	PWD Hot	9/3/2014	
		1	SRV-K Hot	9/3/2014	
		1	SVO-ZV	9/3/2014	
		1	PWD Aux	7/7/2014	
<b>Total:</b>	<b>5</b>				
41	Soyuz 39	1	PWD Hot	10/25/2014	11/11/2014
		1	SRV-K Warm	10/25/2014	
		1	SVO-ZV	10/25/2014	
	<b>Total:</b>	<b>3</b>			

**Table 2. Water Analytical Methods**

Parameter	Method
pH and conductivity	Potentiometric
Total Solids	Gravimetric
Turbidity	Nephelometric
Iodine and iodide	Leuco crystal violet (LCV)
Metals/Minerals	Inductively coupled plasma/mass spectrometry (ICP/MS)
Inorganic anions & cations	Ion chromatography (IC)
Total organic carbon (TOC)	Ultraviolet or heated persulfate oxidation
Alcohols and glycols	Direct injection gas chromatography/mass spectrometry (GC/MS)
Volatile organics	GC/MS with a purge and trap concentrator
Semi-volatile organics	GC/MS after liquid/liquid extraction
Organic acids and amines	Capillary electrophoresis (CE)
Urea/Caprolactam	Liquid chromatography (LC) with UV diode array detector
Formaldehyde	GC/MS after derivatization and extraction
Dimethylsilanediol	LC with refractive index detector

## II. Background

During Expeditions 38-41 in 2014, the ISS crews continued to use several available onboard water supplies including U.S. Segment potable water recovered from humidity condensate and urine distillate, Russian Segment potable water regenerated from humidity condensate, and Russian ground-supplied potable water.

### U.S. Water Processor Assembly

The water processor assembly (WPA) located in the U.S. Segment produces potable water recovered from a combined wastewater feed of urine distillate and humidity condensate. This wastewater is processed into potable water by a combination of treatment processes shown in Figure 1. Multifiltration beds containing a mixture of adsorbents and ion-exchange resins provide removal of dissolved inorganic and organic contaminants. A high-temperature, catalytic-oxidation reactor provides further removal of organic contaminants. A polishing ion-exchange bed provides final treatment to remove organics including reactor by-products and adds residual iodine biocide before storage of the product water for delivery to the ISS potable-water bus. The U.S. potable-water dispenser (PWD) delivers water from the potable bus for crew consumption as either hot or ambient water, after removing the iodine biocide at the point of use.

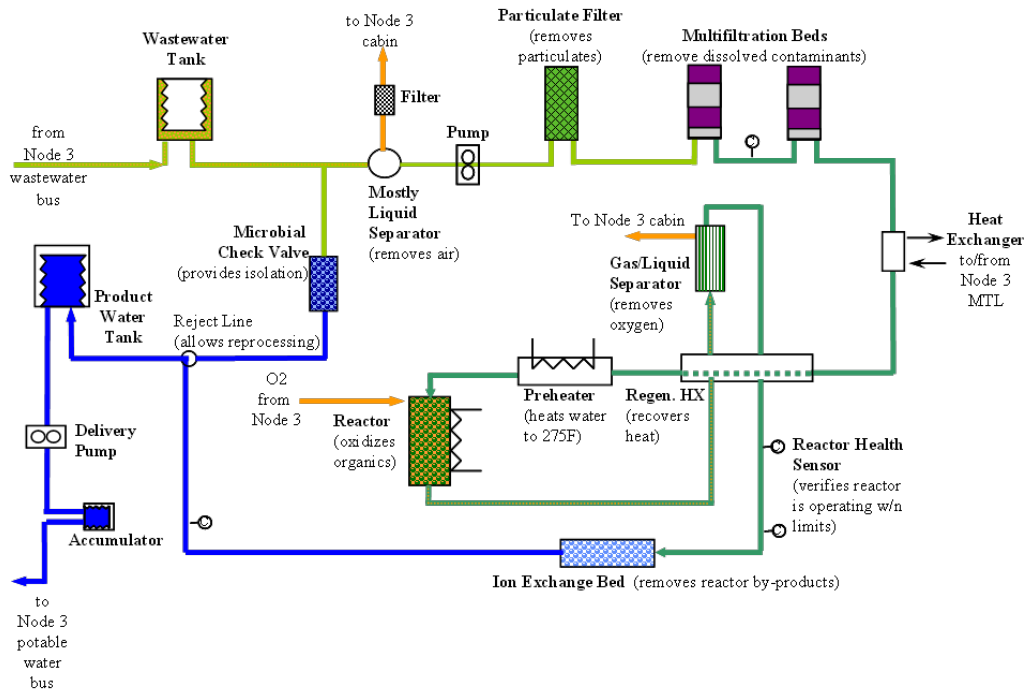

**Figure 1 - U.S. water processor assembly (WPA).**

The total organic carbon analyzer (TOCA) was delivered to ISS in 2008, along with the WPA, to support 6-person crew operations.<sup>15</sup> The TOCA measures total organic carbon (TOC) in the WPA product water without identification of specific organic constituents. The TOCA draws weekly water samples from the WPA product tank directly using a dedicated hose and is also used monthly to analyze a PWD water sample that the crew collects in a dedicated TOCA sample bag.

### Russian Segment Water Systems

The Russian Segment condensate water recovery system (SRV-K) processes atmospheric humidity condensate recovered directly from cabin air into potable water. The SRV-K treatment process includes a catalytic filter reactor, phase separator, and multifiltration beds to remove organic and inorganic contaminants. Silver biocide and minerals (calcium, magnesium, and fluoride) are added using a conditioning bed to the product water before storage. Product water is stored and pasteurized for microbial control before being dispensed from either hot or warm ports of the SRV-K galley (Figure 2). Whenever the demand for drinking water exceeds the availability of condensate, the crews can connect potable water stored in containers to the SRV-K as makeup.

The Russian Segment system for water storage and dispensing (SVO-ZV) consists of a 22-L bladder tank in a hard shell (EDV), a manual air pump to pressurize the tank, and a hand-held dispenser. The EDV is typically filled with Russian ground-supplied potable water delivered to the ISS in the Russian Progress vehicle's 210-L Rodnik tanks. The ISS crews can access potable water at ambient temperature from the SVO-ZV dispenser port (Figure 3).



**Figure 2 - SRV-K Galley.**  
*Collection of archival sample from SRV-K*



**Figure 3 - SVO-ZV stored water dispenser.**  
*Collection of water sample from SVO-ZV*

### **III. Discussion of Analytical Results**

Appendices 1, 2, and 3 provide tabulations of chemical analyses results for ISS return-water samples collected during Expeditions 38-41 from the SRV-K (regenerated), SVO-ZV (stored), and WPA water supplies, respectively. Each data table includes the ISS potability limits for comparison to analytical results. A discussion of the results by expedition, including compliance with ISS standards, follows.

#### **EXPEDITION 38**

Table 1 summarizes the 4 archival potable-water samples that were collected using U.S. water-sample hardware during Expedition 38 (i.e., PWD ambient, PWD hot, SRV-K hot, and SVO-ZV). All 4 samples were returned on Soyuz 36 and received at the JSC on March 12, 2014 for analysis in the TEC laboratory. Due to limited sample volumes, total solids were not measured on any of the samples and turbidity was only measured on the PWD ambient sample.

#### **ISS U.S. Segment**

##### ***PWD Potable-Water Samples***

All chemical parameters measured for the PWD ambient and hot water samples collected on February 3, 2014 and February 24, 2014, respectively, met the potable-water quality requirements in the *System Specification for the International Space Station*, SSP 41000<sup>14</sup>. Figure 4 provides a historical plot of iodine levels in samples collected from the U.S. potable-water system. Total iodine levels in the February PWD samples were below the method detection limit of 0.05 mg/L and met the ISS acceptability limit at the point of consumption of <0.2 mg/L. The TOC concentrations in the ambient and hot samples were <0.10 and 0.13 mg/L, respectively, both well below the U.S. Segment TOC limit of 3.0 mg/L. These values are consistent with the in-flight data from the TOCA for

samples collected on the same day as the archives, as shown in Table 3. The long-term TOC trend in water samples collected from the WPA is shown in Figure 5. Dimethylsilanediol, which was the lone compound responsible for previous TOC rises in 2010, 2012, and 2013<sup>16-17</sup> (see TOC excursions in Figure 5), was not detected (<0.5 mg/L) in either of the February PWD samples. Furthermore, the only individual organic constituent identified in the samples was methyl sulfone at levels of 61 to 99 µg/L (Figure 6). Organic carbon accountability in the PWD hot sample was 20% with 0.10 mg/L of unaccounted TOC. As the TOC concentration in the PWD ambient sample was below reporting limits, it was not possible to calculate a percent accountability for organic carbon.

**Table 3. Comparison of Archive and TOCA Results**

TOCA In-flight Results			Archive Results		
Date	Location	TOC (mg/L)	Date	Location	TOC (mg/L)
2/03/14	PWD Ambient	<0.285	2/03/14	PWD Ambient	<0.10
2/24/14	PWD Hot	<0.285*	2/24/14	PWD Hot	0.13

\*TOCA terminated in 3rd replicate due to insufficient sample volume; reported value is the average of the 2 completed replicates.

### ISS Russian Segment

#### *SRV-K Potable-Water Sample*

All chemical parameters measured for the SRV-K hot water sample collected on February 24, 2014 met the potable-water quality requirements listed in the ISS MORD document<sup>13</sup>. Detectable levels of aluminum (87 µg/L), barium (10 µg/L), copper (7 µg/L), iron (20 µg/L), manganese (22 µg/L), nickel (40 µg/L), zinc (20 µg/L), and silicon (1050 µg/L) were found in the sample. A plot of historical nickel levels for SRV-K samples is shown in Figure 7. The total silver level was 98 µg/L, which is slightly below the minimum desired biocidal level of 100 µg/L and may increase the risk of microbial growth. A plot of historical organic carbon levels for SRV-K samples is shown in Figure 8. The TOC level of 0.47 mg/L was well below the ISS MORD limit (Figure 8) and no target organic compounds were detected.

#### *SVO-ZV Potable-Water Sample*

All chemical parameters measured for the SVO-ZV water sample collected on February 24, 2014 met the potable-water quality requirements listed in the ISS MORD with the exception of manganese. An updated plot of the historical trend for manganese in SVO-ZV samples is shown in Figure 9. The manganese concentration of 54 µg/L was slightly above the ISS MORD requirement of 50 µg/L, but well below the *Spacecraft Water Exposure Guideline* (SWEG) of 300 µg/L.<sup>18</sup> The total silver level was 11 µg/L, which is well below the minimum desired biocidal level of 100 µg/L and may increase the risk of microbial growth. The TOC concentration of 1.06 mg/L was well below the ISS MORD limit. Two target organic compounds were detected at low levels in the sample: benzothiazole (28 µg/L) and 2-methylthiobenzothiazole (24 µg/L). There are no EPA MCLs or SWEGs for these compounds.

### EXPEDITION 39

Two archival potable-water samples were returned from Expedition 39, as detailed in Table 1. The samples were collected on March 31, 2014 from PWD ambient and on May 6, 2014 from PWD hot and were returned on Soyuz 37. Due to the unavailability of crew time for water sampling during Expedition 39, no Russian Segment water samples were collected. Samples were received at JSC on May 15, 2014 for analysis in the TEC laboratory. Due to limited sample volumes, total solids were not measured on either of the samples and turbidity was only measured on the PWD ambient sample.

### ISS U.S. Segment

#### *PWD Potable-Water Samples*

All chemical parameters measured on the March and May PWD samples met the U.S. Segment potable-water requirements. Total iodine was below the method detection limit of <0.05 mg/L in the samples and met the 0.2 mg/L maximum at the point of consumption (Figure 4). The TOC concentrations in the March and May samples were 0.14 and 0.18 mg/L, respectively, and well below the U.S. Segment limit of 3.0 mg/L (Figure 5). These archive sample TOC values are consistent with the in-flight TOCA data, as shown in Table 4. Dimethylsilanediol was not detected (<0.5 mg/L) in either of the samples. Methyl sulfone was the only organic compound identified in the samples at levels in the range of 44-72 µg/L (Figure 6). The organic carbon accountabilities were 8% for the March sample and 10% for the May sample.

**Table 4. Comparison of Archive and TOCA Results**

TOCA In-flight Results			Archive Results		
Date	Location	TOC (mg/L)	Date	Location	TOC (mg/L)
3/31/14	PWD Ambient	<0.285	3/31/14	PWD Ambient	0.14
5/06/14	PWD Hot	<0.285	5/06/14	PWD Hot	0.18

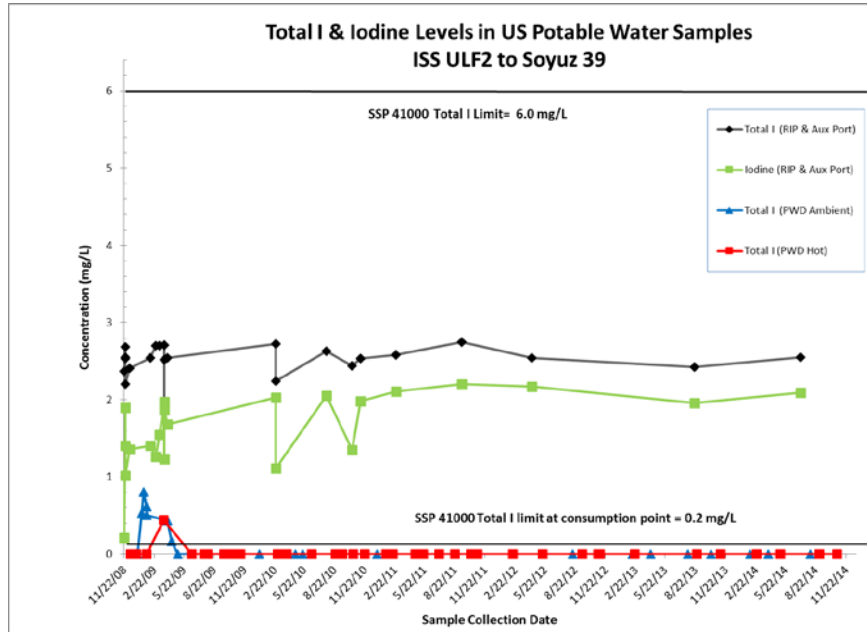

**Figure 4 - Total I and iodine levels in U.S. potable-water samples ISS ULF2 to Soyuz 39.**

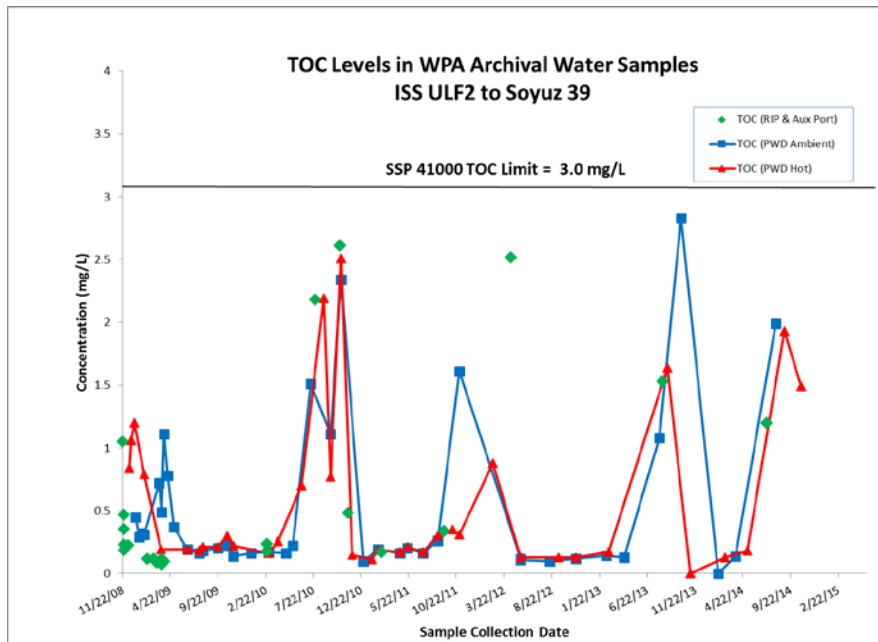

**Figure 5 - TOC levels in WPA archival water samples ISS ULF2 to Soyuz 39.**

*Note the 4 separate TOC rises in 2010, 2012, 2013, and 2014 from dimethylsilanediol breakthrough*

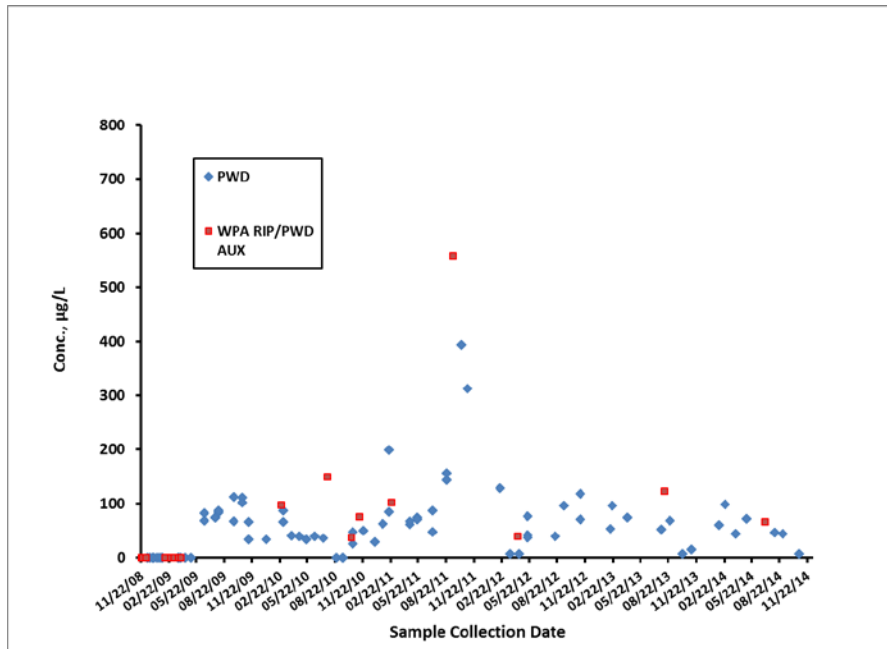

Figure 6 - Methyl sulfone in U.S. potable-water samples ISS ULF2 to Soyuz 39.

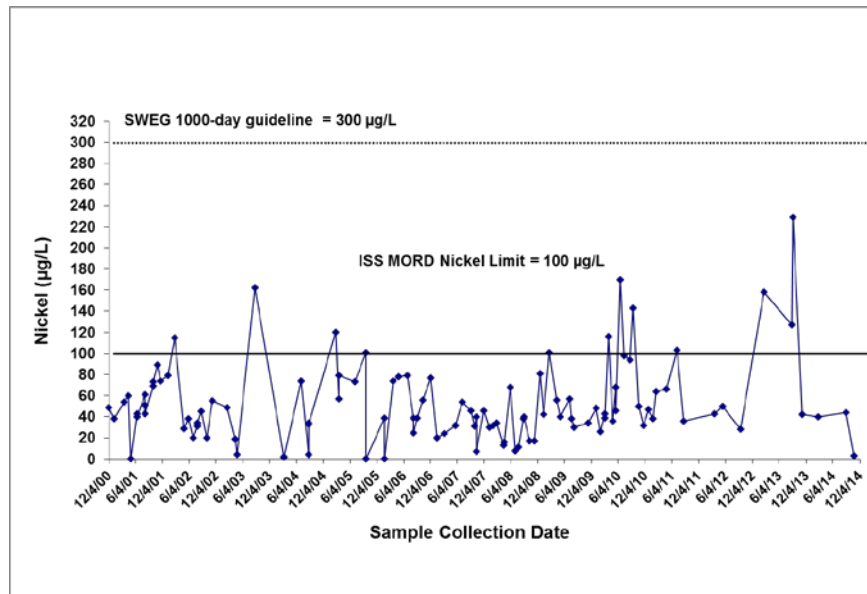

Figure 7 - Nickel levels in SRV-K water samples ISS Flights 4A to Soyuz 39.



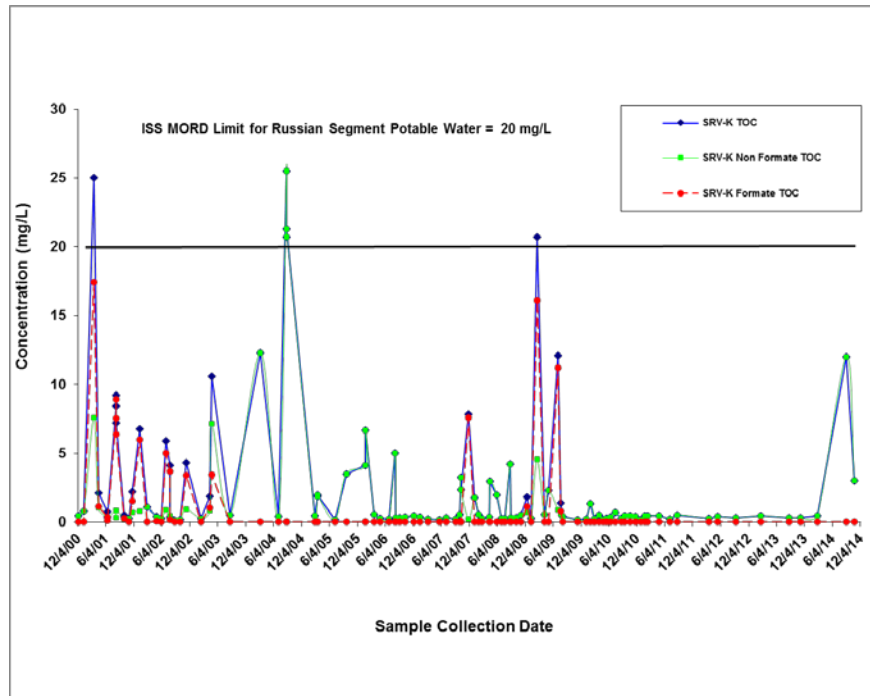

Figure 8 - Total, formate, and nonformate organic carbon in SRV-K potable water ISS Flights 4A to Soyuz 39.

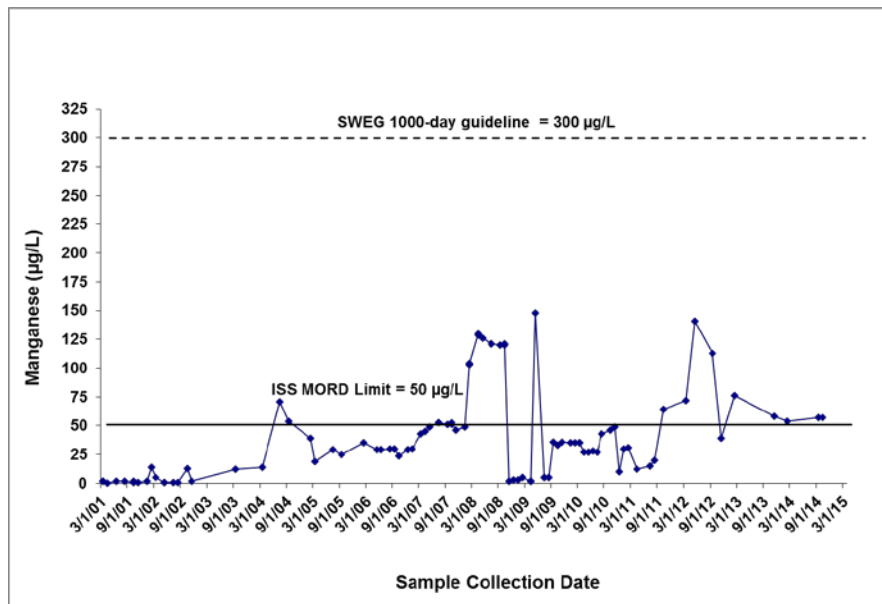

Figure 9 - Manganese levels in SVO-ZV water samples ISS Flights 5A to Soyuz 39.

#### EXPEDITION 40

As detailed in Table 1, a total of 5 archival-water samples were collected using U.S. water-sample hardware during Expedition 40 (PWD ambient, PWD hot, SRV-K hot, SVO-ZV, and PWD Aux). All of these samples were returned on Soyuz 38 and received in the TEC laboratory on September 11, 2014. Due to limited sample volume, total solids were not measured on any of the samples and turbidity was only measured on the PWD ambient and SRV-K hot samples.

Beginning in June of 2014, the U.S. Segment potable water experienced an expected temporary rise and fall in TOC content, as the result of organic contamination breaking through the water processor assembly. The onboard TOCA was used to detect and monitor this TOC rise. The long term TOC trend in water produced by the U.S. WPA is shown in Figure 5. Expedition 40 archival sample results confirmed the in-flight TOC data and confirmed that dimethylsilanediol was the sole responsible contaminant, just as it was for comparable TOC rises in 2010, 2012, and 2013<sup>16,17</sup>.

## ISS U.S. Segment

### *PWD Potable-Water Samples*

Two PWD samples were collected during Expedition 40 on August 6, 2014 (ambient) and September 3, 2013 (hot). All chemical parameters measured for these 2 samples met the U.S. Segment potable-water quality requirements. Total iodine in the samples was below the method detection limit of <0.05 mg/L and met the requirement of ≤0.2 mg/L at the point of consumption (Figure 4).

The TOC levels were 1.99 and 1.93 mg/L in the PWD ambient and hot samples, respectively (Figure 5). Although well below the 3.0 mg/L limit for the U.S. Segment, these levels confirmed the upward trend in WPA product water and were in close agreement with the in-flight TOCA data as shown in Table 5. These data also confirmed the replacement ISS TOCA unit (PFU2) that became operational in June 4, 2013 continued to operate nominally and with excellent accuracy.

**Table 5. Comparison of E40 Archive Samples to In-flight TOCA Results**

In-flight Results			Archive Results		
Date	Location	TOC (mg/L)	Date	Location	TOC (mg/L)
8/6/14	PWD ambient	1.99	8/6/14	PWD ambient	1.99
9/3/14	PWD hot	2.07	9/3/14	PWD hot	1.93

The dimethylsilanediol was in the range of 6.9 to 7.2 mg/L in the PWD samples, which is above nominal levels but below the 35.0 mg/L SWEG.<sup>19</sup> Methyl sulfone was the only other organic compound detected in the samples and it ranged from 45 to 47 µg/L (Figure 6). The organic carbon accountability of the PWD samples ranged from 93 to 95%, with less than 0.2 mg/L of TOC unaccounted, confirming that the 2014 rise in TOC level of WPA product water was again due to dimethylsilanediol.

### *Product Water Sample (PWD Aux)*

A product-water sample was collected from the PWD Aux port on July 7, 2014. The TOC in this sample was 1.2 mg/L (Figure 5). The only organic compounds detected were dimethylsilanediol (4.1 mg/L), methyl sulfone (66 µg/L), and formaldehyde (13 µg/L). The organic carbon accountability was >90%, with less than 0.2 mg/L TOC unaccounted. The iodine level was 2.09 mg/L and within the required range of 1.0 to 4.0 mg/L residual iodine.

## ISS Russian Segment:

### *SRV-K Potable-Water Sample*

All chemical parameters measured for the SRV-K hot water sample collected on September 3, 2014 met the potable-water quality requirements listed in the ISS MORD document with the exception of manganese. The manganese concentration was 85 µg/L, which is above the MORD limit of 50 µg/L but well below the SWEG of 300 µg/L. The nickel level was 44 µg/L (Figure 7). The total silver level of 36 µg/L was well below the desired biocidal range of 100 to 500 µg/L, which can increase the risk of microbial growth. The TOC level of 12.0 mg/L was well below the MORD limit of 20 mg/L, but much higher than the historical average (~ 3 mg/L) as shown in Figure 8. Essentially all of the TOC present in the sample was accounted for by ethanol (20.3 mg/L) and methanol (3.2 mg/L). These concentrations are the highest detected in an SRV-K sample since 2004. The source of the ethanol has not been determined, but data from the U.S. Air Quality Monitor (AQM) showed elevated ethanol levels in the ISS atmosphere during Increment 40. Trace amounts of acetone (27 µg/L) and formaldehyde (20 µg/L) were also detected in the SRV-K sample. The organic carbon accountability was >98%, with 0.21 mg/L TOC unaccounted.

### *SVO-ZV Potable-Water Sample*

All chemical parameters measured for the SVO-ZV water sample collected on September 3, 2014 met requirements listed in the ISS MORD with the exception of manganese. The manganese level of 57 µg/L was slightly

above the MORD requirement of 50 µg/L, but well below the SWEG of 300 µg/L (Figure 9). The total silver concentration of 46 µg/L was below the minimum acceptable biocidal level, which increases the risk of microbial growth in the system. The TOC concentration in the sample was 1.15 mg/L. The only organic compound identified in the sample was chloroform, which was present at a trace level of 5 µg/l.

#### **EXPEDITION 41**

Three archival potable-water samples were collected using U.S. water sample hardware during Expedition 41 (PWD hot, SRV-K warm, and SVO-ZV) as summarized in Table 1. All 3 samples were returned on Soyuz 39 and received in the TEC laboratory on November 11, 2014. Due to limited sample volumes, total solids were not analyzed on any of the samples and turbidity was only measured on the SRV-K warm sample.

By mid-October of 2014 the continued rise in TOC of WPA product water had surpassed the U.S. segment limit of 3.0 mg/L, as measured by the onboard TOCA (i.e., 3.4 mg/L on October 14). Fortunately, the Expedition 40 archive sample results returned on Soyuz 38 on September 11, 2014 had already confirmed that dimethylsilanediol was the responsible contaminant. With this confirmation in hand and based upon the low toxicity of dimethylsilanediol, a waiver was approved to allow the crew to temporarily continue to consume the water. On October 17, 2014 the WPA multifiltration beds were replaced and within several weeks the TOC levels had returned to nominal levels below the TOCA method detection limit of 285 µg/L.

#### **ISS U.S. Segment**

##### ***PWD Potable-Water Samples***

All chemical parameters measured for the PWD hot water sample collected on October 25, 2014 met the U.S. Segment potable-water quality requirements. Total iodine levels were below the method detection limit of 0.05 mg/L and met the ISS acceptability limit at the point of consumption of <0.2 mg/L (see Figure 4). The total organic carbon (TOC) concentration in the sample was 1.49 mg/L (Figure 5). This concentration is significantly higher than the typical TOC levels seen in U.S. potable-water samples (< 285 µg/L), but it is below the SWEG of 3.0 mg/L.<sup>18</sup> The TOC concentration measured in the hot water sample on the ground showed excellent agreement with in-flight data collected using the TOCA as shown in Table 6. Dimethylsilanediol was detected in the hot water sample (5.5 mg/L) and accounted for > 96% of the measured TOC. No other organic compounds were detected in the sample, reconfirming that dimethylsilanediol was responsible for the 2014 TOC rise. The lower TOC level found in the October 25, 2014 PWD sample confirmed the in-flight TOCA data showing a reversal of the TOC trend after replacement of the WPA multifiltration beds on October 17 (Figure 5).

**Table 6. Comparison of E41 Archive Samples to In-flight TOCA Results**

<b>In-flight Results</b>			<b>Archive Results</b>		
<b>Date</b>	<b>Location</b>	<b>TOC(mg/L)</b>	<b>Date</b>	<b>Location</b>	<b>TOC (mg/L)</b>
10/25/14	PWD hot	1.43	10/25/14	PWD hot	1.49

#### **ISS Russian Segment**

##### ***SRV-K Potable-Water Sample***

All chemical parameters measured for the SRV-K warm water sample collected on October 25, 2014 met the potable-water quality requirements listed in the ISS MORD with the exception of silver. The silver concentration was 760 µg/L, which is above both the SWEG and MORD requirements of 400 and 500 µg/L, respectively. This sample contained significant visible particulates. Elemental analysis of the particulates indicated that they were predominantly silver chloride, which is consistent with the high silver concentration measured in the sample. It is believed that the high silver concentration and particulate load resulted from the crew inadvertently using disinfectant solution to supplement water production. The disinfectant solution contains 10 mg/L of colloidal silver. The TOC level of 2.97 mg/L was well below the ISS MORD limit (Figure 8) and acetone (6 g/L) and chloroform (45 g/L) were the only organic compounds detected.

##### ***SVO-ZV Potable-Water Sample***

All chemical parameters measured for the SVO-ZV water sample collected on October 25, 2014 met the potable-water quality requirements listed in the ISS MORD with the exception of manganese. The manganese concentration of 57 µg/L was slightly above the ISS MORD requirement of 50 µg/L, but well below the SWEG of 300 µg/L (Figure 9). The total silver level of 67 µg/L was below the minimum acceptable biocidal level of 100 µg/L,

which can increase the risk of microbiological growth. The TOC concentration of 1.09 mg/L was well below the ISS MORD limit, and chloroform (6 µg/L) was the only organic compound detected in the sample.

#### **IV. Conclusions and Recommendations**

The WPA potable water was chemically acceptable for consumption by the ISS crews during Expeditions 38-41, as demonstrated by the chemical analyses results for PWD archive-water samples collected in 2014 and returned on Soyuz flights 36-39. Beginning in June of 2014, the WPA water experienced an anticipated temporary rise and fall in TOC content, as the result of organic contamination breaking through the treatment processes. By mid-October of 2014 the TOC levels had exceeded the U.S segment limit of 3.0 mg/L; however, results for Expedition 40 archive samples returned on Soyuz 38 in September had already confirmed dimethylsilanediol to be the responsible contaminant. Based upon the low toxicity of dimethylsilanediol, a waiver was approved by the ISS Program to allow the crew to temporarily continue to consume the water. Several weeks after the WPA multifiltration beds were replaced on October 17, 2014 the TOC levels returned to nominal levels below the TOCA detection limit of 285 µg/L. Analytical results for the Expedition 41 PWD sample collected in October confirmed the reversal of the TOC trend as seen in the TOCA data and reaffirmed that breakthrough of dimethylsilanediol was the cause of the TOC rise, just as it was for the 2010, 2012, and 2013 TOC rises. The level of dimethylsilanediol in the PWD archive samples reached a high of 7.2 mg/L before falling back below the detection limit, but never came close to the 35.0-mg/L SWEG limit. Although below levels of health concern, dimethylsilanediol may still affect the WPA performance by masking the presence of low-levels of other organic compounds that might also break through the system. Although the 2014 TOC rise was anticipated based upon experience and lessons learned from the previous TOC rises of 2010, 2012, and 2013, the WPA internal conductivity sensors were again ineffective in signaling dimethylsilanediol breakthrough. Nevertheless, the TOCA continued to demonstrate its value and necessity as a key monitoring tool for tracking TOC rises and for scheduling water system remediate action (MF bed R&R). The in-flight TOCA results during the recent TOC rise were consistent with the archive sample results as shown in Tables 3-6, thereby reconfirming TOCA accuracy for detecting dimethylsilanediol. Even though the timing of dimethylsilanediol breakthrough is now fully understood, predictable and being tracked, a multidiscipline team effort is still ongoing to establish root cause and the environmental source(s) of dimethylsilanediol in WPA product water.

The chemical analyses results for the Russian Segment archival-water samples collected in 2014 from the SRV-K and SVO-ZV during Expeditions 38-41 indicate that the potable water was chemically acceptable for crew consumption. Silver biocide levels in all SVO-ZV samples were below the minimum acceptable biocide level of 100 µg/L, which can increase the risk of microbial growth. Manganese slightly exceeded the ISS MORD limit of 50 µg/L in all 3 of the SVO-ZV samples returned from Expeditions 38-41; however, levels remained well below the 300-µg/L SWEG limit. Even though the Russian stored-water system is not widely used by the crews, it is recommended to continue monitoring manganese in the SVO-ZV water supply. Total silver levels in 2 of 4 SRV-K samples were below the desired minimum biocide level of 100 µg/L, indicating that the primary means of microbial control in the SRV-K galley continues to be heating of the water by the pasteurization unit. The silver concentration of 760 µg/L in the SRV-K sample collected on October 25, 2014, was well above both the SWEG and MORD requirements of 400 and 500 µg/L, respectively, and this sample contained significant visible particulates. Elemental analysis indicated that the particulates were predominantly silver chloride, which is consistent with the high silver level in the sample. It is believed that the high silver concentration and particulate load resulted from the crew inadvertently using disinfectant solution containing 10 mg/L of colloidal silver to augment SRV-K water production. Manganese exceeded the ISS MORD limit in the SRV-K sample collected September 3, 2014; however, levels remained well below the 300-µg/L SWEG limit. It is recommended to continue monitoring of manganese, biocide level, and microbial content in SRV-K water.

#### **Appendices**

Appendix 1 and Appendix 2 provide the chemical analysis results for archival potable-water samples returned in 2014 from the Russian Segment SRV-K (regenerated water) and SVO-ZV (stored water) systems, respectively. Appendix 3 contains the results for U.S. Segment archival-water samples that were collected from the PWD hot, ambient, and Aux ports during Expeditions 38-41 and returned in 2014.

## Acknowledgments

All of the analytical work described herein was performed at the NASA Johnson Space Center under NASA contract NAS9-02078. The authors wish to acknowledge the ISS Expeditions 38-41 crews for performing collection and stowage of the archival-water samples that were returned during 2014. The following TEC water laboratory chemists are gratefully acknowledged for performing chemical analyses of the ISS return water samples: Jim Alverson, Mickie Benoit, Robert Gillispie, Mike Kuo, and Jeff Rutz. Further acknowledgment also goes to Mickie Benoit for coordinating the retrieval of the ISS water samples returned on Soyuz and delivery of those samples to JSC. The following Russian colleagues are also formally acknowledged: Elena Zaprygaylo of RSC-Energia, Yuri Sinyak of the Institute of Biomedical Problems, and Leonid Bobe of NIICHIMMASH.

## References

- <sup>1</sup>Straub, J.E., Plumlee, D. K., Schultz, J. R., and Mudgett, P.D., “International Space Station Potable Water Characterization for 2013”, ICES-2014-190, *Proceedings of the 2014 International Conference on Environmental Systems*, 2014.
- <sup>2</sup>Straub, J.E., Plumlee, D. K., Schultz, J. R., and McCoy, J.T., “Potable-Water Quality for International Space Station Expeditions 30-33”, AIAA-2013-3310, *AIAA Proceedings of the 2013 International Conference on Environmental Systems*, 2013.
- <sup>3</sup>Straub, J.E., Plumlee, D. K., Schultz, J. R., and McCoy, J.T., “International Space Station Potable Water Quality for Expeditions 26 through 29”, AIAA-2012-3413, *AIAA Proceedings of the 2012 International Conference on Environmental Systems*, 2012.
- <sup>4</sup>Straub, J. E., Plumlee, D. K., Schultz, J. R., and McCoy, J.T., “Chemical Analysis Results for Potable Water for ISS Expeditions 21-25”, AIAA-2011-5152, *AIAA Proceedings of the 2011 International Conference on Environmental Systems*, 2011.
- <sup>5</sup>Straub, J. E., Plumlee, D. K., and Schultz, J. R., “ISS Expeditions 16 thru 20: Chemical Analysis Results for Potable Water”, AIAA-2010-6042, *AIAA Proceedings of the 2010 International Conference on Environmental Systems*, 2010.
- <sup>6</sup>Straub, J. E., Plumlee, D. K., and Schultz, J. R., “Chemical Analysis Results for Potable Water Returned from ISS Expeditions 14 and 15”, *SAE International Journal of Aerospace*. 1(1): 556-577, 2008.
- <sup>7</sup>Straub, J. E., Plumlee, D. K., and Schultz, J. R., “Sampling and Chemical Analysis of Potable Water for ISS Expeditions 12 and 13”, *SAE International Journal of Aerospace*, 2007.
- <sup>8</sup>Straub, J. E., Plumlee, D. K., and Schultz, J. R., “ISS Expeditions 10 & 11 Potable Water Sampling and Chemical Analysis Results”, *SAE International Journal of Aerospace*, 2006.
- <sup>9</sup>Straub, J. E., Plumlee, D. K., and Schultz, J. R., “Chemical Analysis of ISS Potable Water from Expeditions 8 and 9”, *SAE International Journal of Aerospace*, 2005.
- <sup>10</sup>Straub, J. E., Plumlee, D. K., and Schultz, J. R., “ISS Potable Water Sampling and Chemical Analysis: Expeditions 6 & 7”, *SAE International Journal of Aerospace*, 2004.
- <sup>11</sup>Plumlee, D. K. and Schultz, J. R., “ISS Potable Water Sampling and Chemical Analysis: Expeditions 4 & 5”, *SAE International Journal of Aerospace*, 2003.
- <sup>12</sup>Plumlee, D. K. and Schultz, J. R., “Chemical Sampling and Analysis of ISS Potable Water: Expeditions 1-3”, *SAE International Journal of Aerospace*, 2002.
- <sup>13</sup>*ISS Medical Operations Requirements Document*, SSP 50260, Revision C, NASA Johnson Space Center, February 2006, Section 7.2 and Appendix D, Table D-1.
- <sup>14</sup>*System Specification for the International Space Station*, SSP 41000 BY, National Aeronautics and Space Administration, September 21, 2012, Table LXX.
- <sup>15</sup>Bentley, N, et al., “Second-Generation International Space Station Total Organic Carbon Analyzer Verification Testing and On-Orbit Performance Results”, AIAA-2010-6043, *AIAA Proceedings of the 2010 International Conference on Environmental Systems*, 2010.
- <sup>16</sup>Rutz, J. A. et al., “Discovery and Identification of Dimethylsilanediol as a Contaminant in ISS Potable Water”, AIAA-2011-5154, *AIAA Proceedings of the 2011 International Conference on Environmental Systems*, 2011.
- <sup>17</sup>McCoy, J. T. et al., “The Story Behind the Numbers: Lessons Learned from the Integration of Monitoring Resources in Addressing an ISS Water Quality Anomaly”, AIAA-2011-5153, *AIAA Proceedings of the 2011 International Conference on Environmental Systems*, 2011.
- <sup>18</sup>*Spacecraft Water Exposure Guidelines (SWEGS)*, JSC-63414, NASA Johnson Space Center, November 2008.
- <sup>19</sup>Ramanathan, R., James, J.T., and McCoy, J.T., “Acceptable levels for ingestion of dimethylsilanediol in water on the International Space Station”, *Aviat Space Environ Med*, 2012 Jun; 83(6); 598-603.