



**INTERNATIONAL
ASTRONAUTICAL
FEDERATION**

Update on Risk Reduction Activities for a Liquid Advanced Booster for NASA's Space Launch System

**Andy Crocker
Dynetics, Inc.**

68th International Astronautical Congress, Adelaide, Australia, Sept 25-29, 2017



Overview and Introduction to ABEDRR

- **Goals of NASA's Advanced Booster Engineering Demonstration and/or Risk Reduction (ABEDRR) are to:**
 - Reduce risks leading to an affordable Advanced Booster that meets the evolved capabilities of SLS
 - Enable competition by mitigating targeted Advanced Booster risks to enhance SLS affordability
- **SLS Block 1 vehicle is being designed to carry 70 mT to LEO**
 - Uses two five-segment solid rocket boosters (SRBs) similar to the boosters that helped power the space shuttle to orbit
- **Evolved 130 mT payload class rocket requires an advanced booster with more thrust than any existing U.S. liquid- or solid-fueled boosters**



Scope of This Presentation

- **In October 2012 and February 2013, NASA awarded a contract to Dynetics, Inc. (with Aerojet Rocketdyne as a major subcontractor):**
 - To demo the use of modern manufacturing techniques to produce and test several primary components of the F-1 rocket engine originally developed for the Apollo Program, including an integrated powerpack
 - To demo innovative fab techniques for metallic cryo tanks
- **Early 2014, NASA and Dynetics agreed to move additional large liquid oxygen/kerosene engine work under Dynetics**
 - Originally had been its own ABEDRR prime contract to Aerojet
- **Led by Aerojet Rocketdyne, work is focused on an Oxidizer-Rich Staged Combustion (ORSC) cycle engine**
 - Can apply to both NASA's Advanced Booster and other launch vehicle applications, including Atlas V booster engine
 - Effort will demonstrate combustion stability and performance of a full-scale ORSC cycle main injector and chamber
- **This presentation will discuss the Dynetics ABEDRR engine task (both efforts) and structures task achievements to date**

Dynetics Risk Reduction Task Summary



A

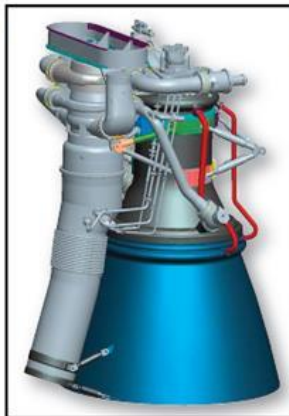

Engineering Demonstrations and Risk Reduction Tasks

Benefit of Proposed Effort/Status at Start of DDT&E

F-1B Engine Risk Reduction

Aerojet Rocketdyne Lead

- | | |
|--|--|
| • Gas Generator Build and Test | • Full-Scale, Low-Cost, Production-Like, Throttling GG Hot-Fired |
| • Turbopump Build | • Full-Scale, Low-Cost, Production-Like, Throttling TPA Built |
| • Powerpack Build and Test | • Full-Scale, Low-Cost, Production-Like, Throttling PPA Hot-Fired |
| • Thrust Chamber Assembly Design and Build | • Full-Scale, Low-Cost, Production-Like, HIP-Bonded TCA Demonstrated |

B



Structures Risk Reduction

Dynetics Lead

- | | |
|------------------------------------|---|
| • Cryotank Assembly Build | • Full-Scale 18-ft Diameter Flight-Like Tank and Intertank Verified |
| • Cryotank Proof and Thermal Cycle | • Full-Scale Design, Tooling, and Build Processes Verified |

A



ORSC Cycle Engine Risk Reduction

Aerojet Rocketdyne Lead

- | | |
|---|--|
| • Main Injector and Thrust Chamber Assembly Design, Build, and Test | • Full-Scale Demonstration of Combustion Stability and Performance Measurement |
|---|--|



Overall F-1B Engine Risk Reduction Summary

- **Program objective was to reduce F-1B engine development risks—despite funding challenges, the effort met this objective:**
 - Demonstrated F-1B engine and component understanding and readiness
 - Completed a heritage gas generator (GG) hot-fire test series, proving throttling capability
 - Completed an additively manufactured GG injector hot-fire test series, proving similarity to heritage
 - Disassembled and reverse engineered existing Mk-10A turbopump
 - Demonstrated long-term affordability through full-scale demonstrations of an additively manufactured GG injector and a cast LOX volute, turbine blades, and turbine manifold
 - Prepared main propellant valves for test
 - Integrated engine loads and design, developed transient operational models, and designed interfaces with the facility for Powerpack testing
 - Developed a new MCC design focused on dramatic cost reductions



Structures Risk Reduction – Cryotank Build

- **Structures risk reduction task planned to validate the designs, materials, equipment, and processes to produce robust and affordable structures**
- **The task created a full-scale cryotank assembly that was verified by proof pressure and cryo-thermal cycle testing**
- **Original plan was to build a tank with four barrel sections, but NASA negotiated with Dynetics to reduce schedule and cost by building a tank with a single cylindrical barrel**
 - **Circumferential welding still demonstrated, and testing still completed**



Structures Risk Reduction – Testing

Cryothermal Cycle / Proof Test



Integrated test article chilled
with LN_2

Burst Test



Moments after tank burst

Ox-Rich Staged Combustion (ORSC) Cycle Engine

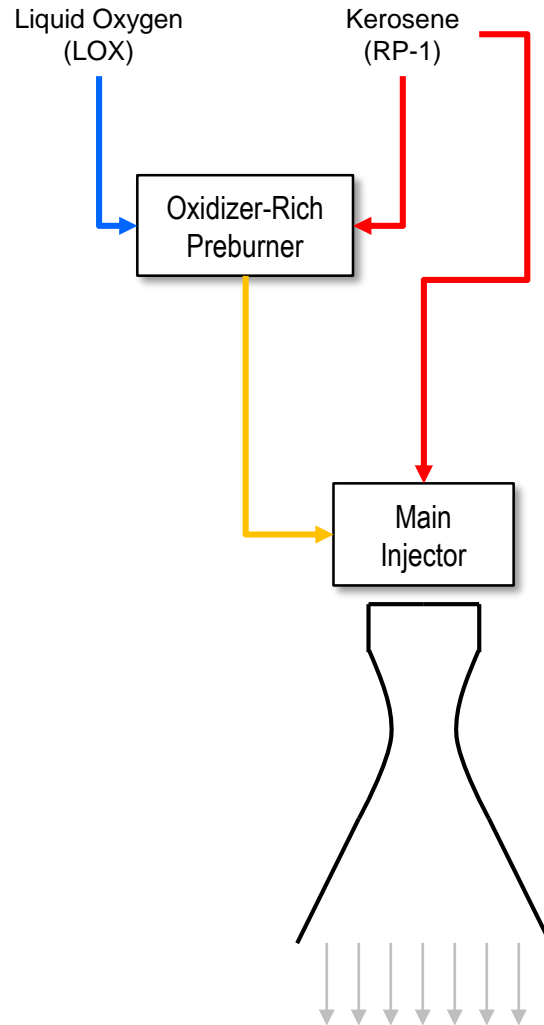

NASA/USAF-Funded Integrated Ox-Rich Test Article

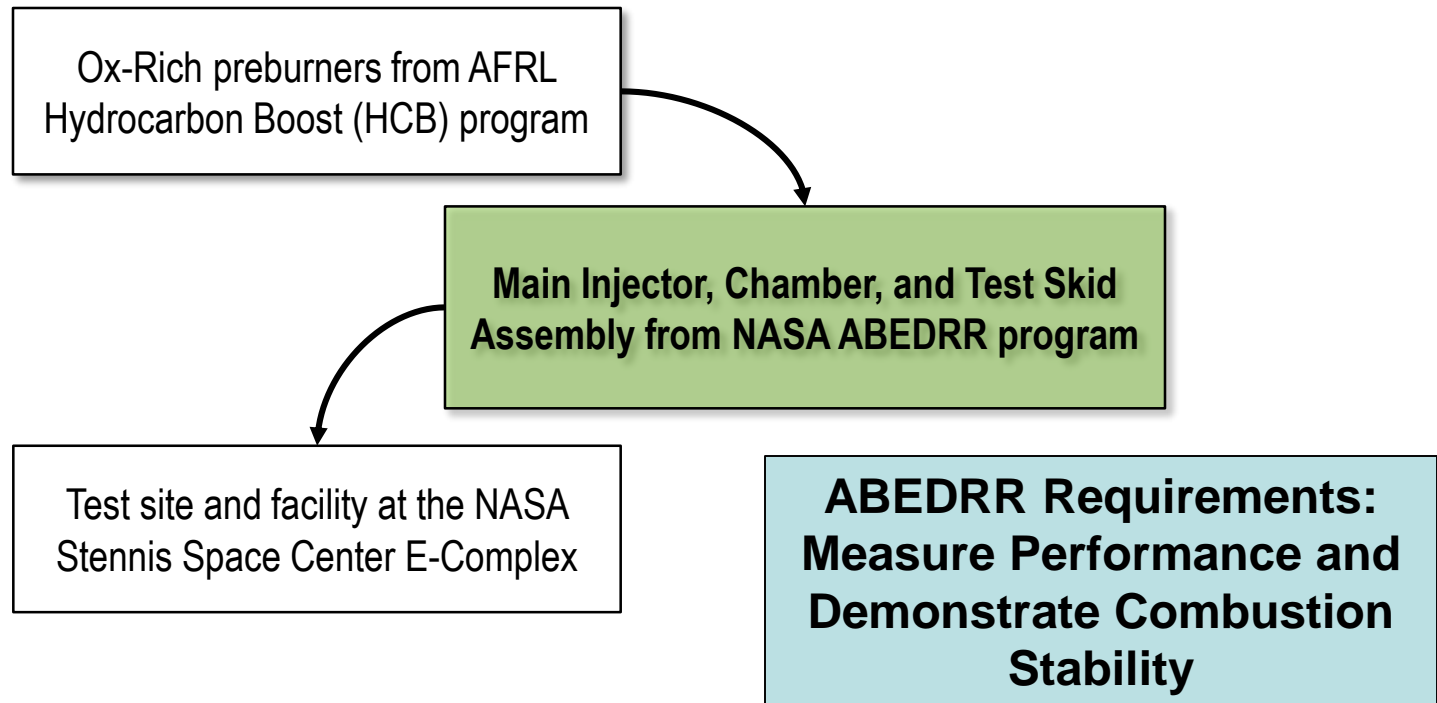

- Preburner testing at the 250 klbf thrust level. ORSC main injector combustion stability and injector performance results at 500 klbf thrust level. Direct design information and model validation data.

Test Configurations

 = ABEDRR Responsibility
 = Focus of this Presentation

1. Single Preburner Testing Configuration

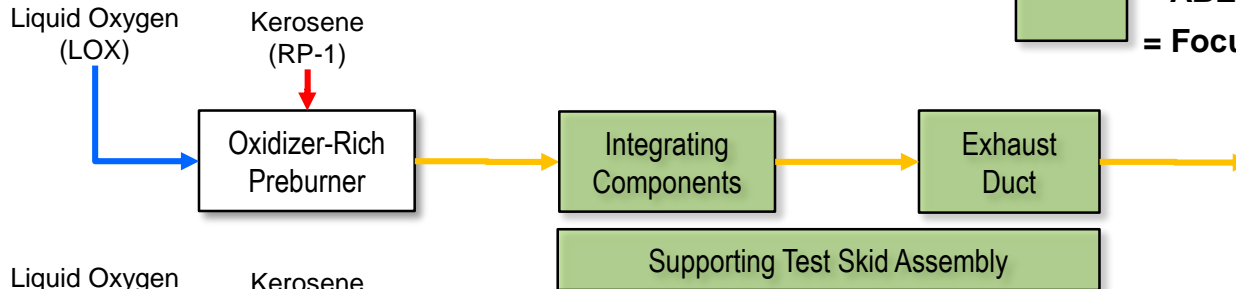

2. Dual Preburner Testing Configuration

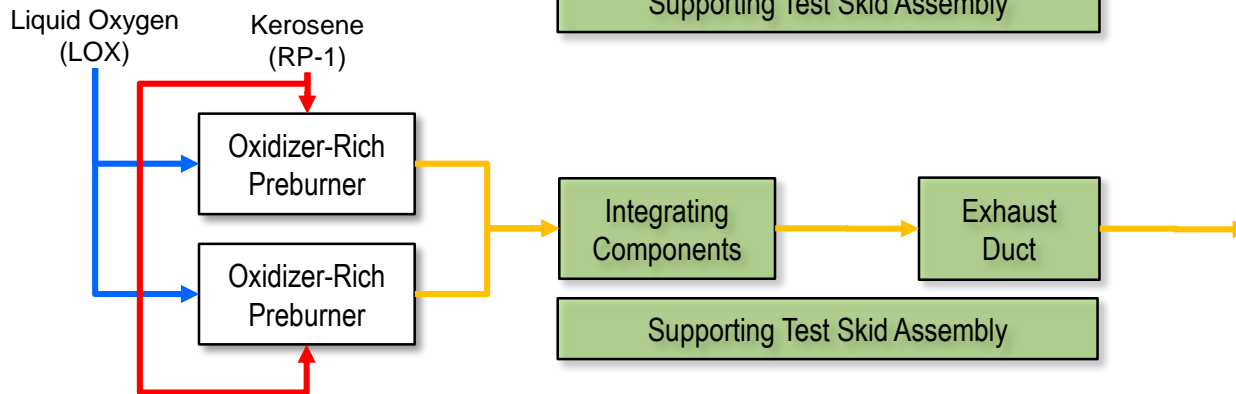

3. Integrated Testing Configuration

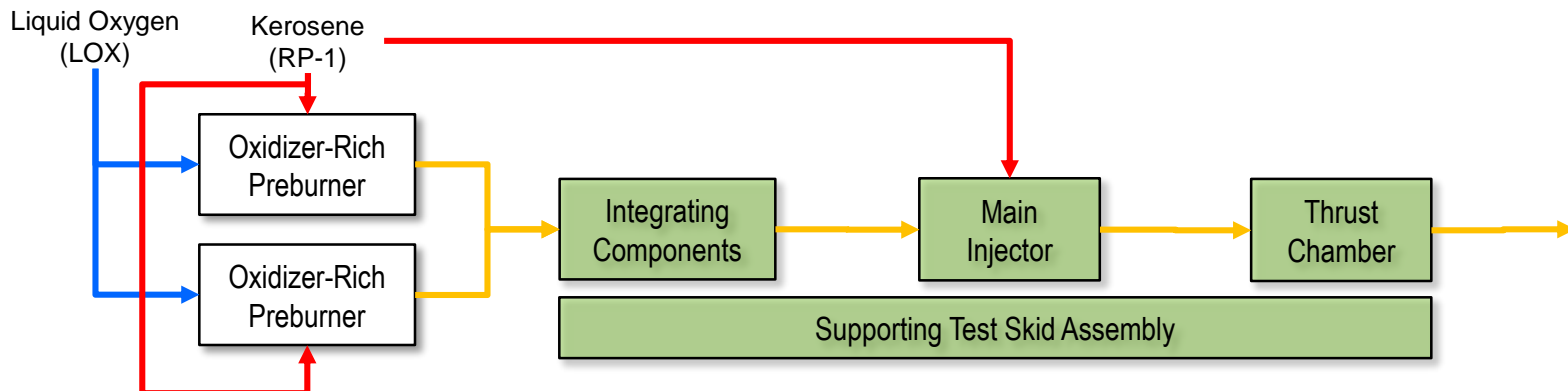



Main Injector Summary Status

- **Completed CDR in Mar 2016; Delta CDR in June 2016 with NASA & USAF**
- **Resolved thermal compatibility issues to eliminate hot spots / streaks**
- **Performed acoustic analyses to find stable configurations and conditions**
- **Performed structural analysis to determine injector has positive margins and meets life requirements**
- **Finalized design of injector elements and injector assembly**
- **Developed fabrication plan; verified with manufacturing demonstrators**
- **100% of drawings completed and released; ~100% out for fabrication**
- **Completed major forgings and finish machining**
- **Completed major assembly tasks**
- **Remaining items include:**
 - **Material coatings (e.g., thermal barrier coatings)**
 - **Small component fabrication for parts to be attached to the injector in the final stages of assembly**
 - **Final assembly and quality inspections**



Chamber Summary Status

- **Chamber = heat sink with 3 locations for boundary layer cooling injection**
- **Ran CFD and thermal analysis to determine driving temperatures at various power levels, engine conditions, cooling flows, etc.**
- **Resolved thermal compatibility issues to eliminate hot spots / streaks**
- **Performed structural analysis to determine chamber has positive margins and meets life requirements**
- **Finalized cooling design with thermal/structural and flow requirements**
- **Finalized design of chamber with features to reduce strain and improve low cycle fatigue; optimized geometry for manufacturability**
- **Defined and demonstrated key manufacturing processes (e.g., brazing)**
- **100% of drawings completed and released; ~100% out for fabrication**
- **Fabrication and machining of hardware nearly all complete**
- **Completed major assembly tasks**
- **Remaining items include:**
 - **Final fabrication steps**
 - **Final assembly and quality inspections**

Examples of Fluid, Thermal, Structural, and Acoustic Analyses

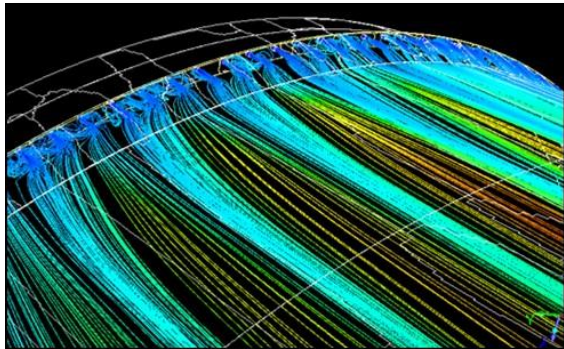

Analysis of coolant flow along chamber wall

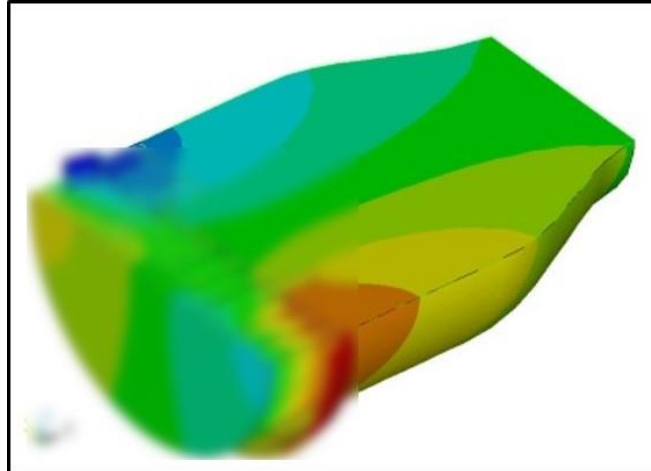

Stability analysis / acoustic modeling of injector and chamber

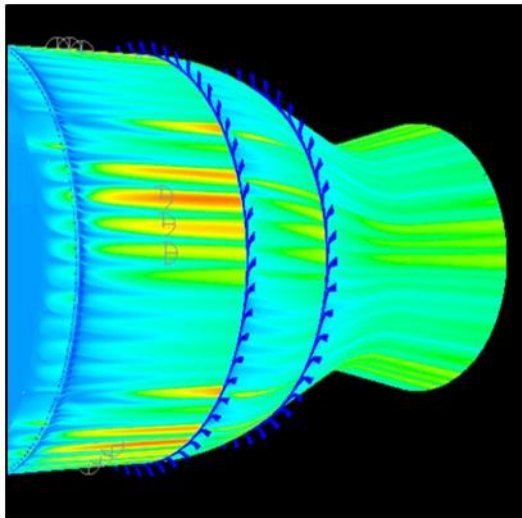

Chamber wall temperature analyses using CFD

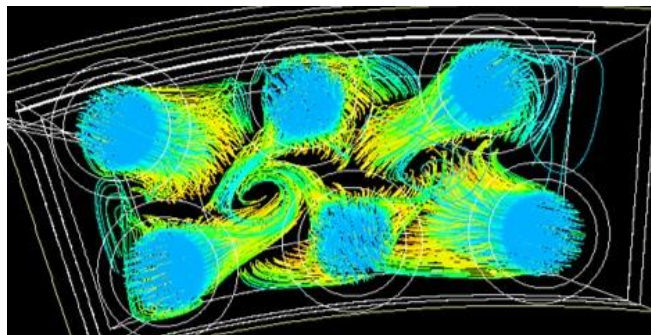

Reacting flow CFD of injector streamlines

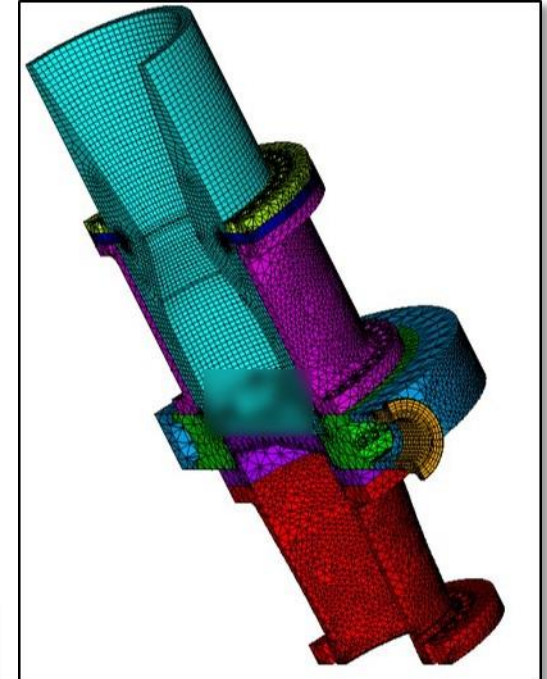

Structural model of thrust chamber assembly



Integrating Components (IC) Summary Status

- **Integrating components = components that direct the hot gas flow from the customer-provided preburners to the exhaust duct (without the injector or TCA) or to the injector and TCA**
- **Completed CDR in Aug 2015; Delta CDR in Nov 2015**
- **100% of drawings completed and released; 100% out for fabrication**
- **Completed pouring and casting of all cast parts**
- **Started all additively manufactured parts; some already completed**
- **Machining of hardware on major parts nearly complete**
- **Most major components have already finished fabrication and are in storage at AR's NASA Stennis Space Center (SSC) location**
- **Remaining items include:**
 - **Complete fabrication on remaining components**
 - **Complete quality inspections**



Test Skid Assembly Summary Status

- **Test skid assembly = test article support structure that provides the structural interface for the test article(s) to the test facility**
- **Finalized the design and analysis, completing a Detailed Design Review (DDR) in Feb 2016**
- **Completed manufacture, assembly, and testing of all hardware**
- **Conducted Hardware Acceptance Review (HAR) in Jan 2017**
 - Verified that the assembly and all associated hardware met requirements
 - Delivered thrust takeout structure, test skid (with mounted carriage assembly), and primary exhaust duct to SSC
- **Conducted Delta HAR in Apr 2017**
 - Delivered secondary (backup) exhaust duct to SSC
- **All waiting in storage waiting to be installed**

Test Skid Assembly Design Status

- Completed CoDR in Oct 2015, PDR in Dec 2015, DDR in Feb 2016
- Completed HAR in Jan 2017 and Delta HAR in Apr 2017

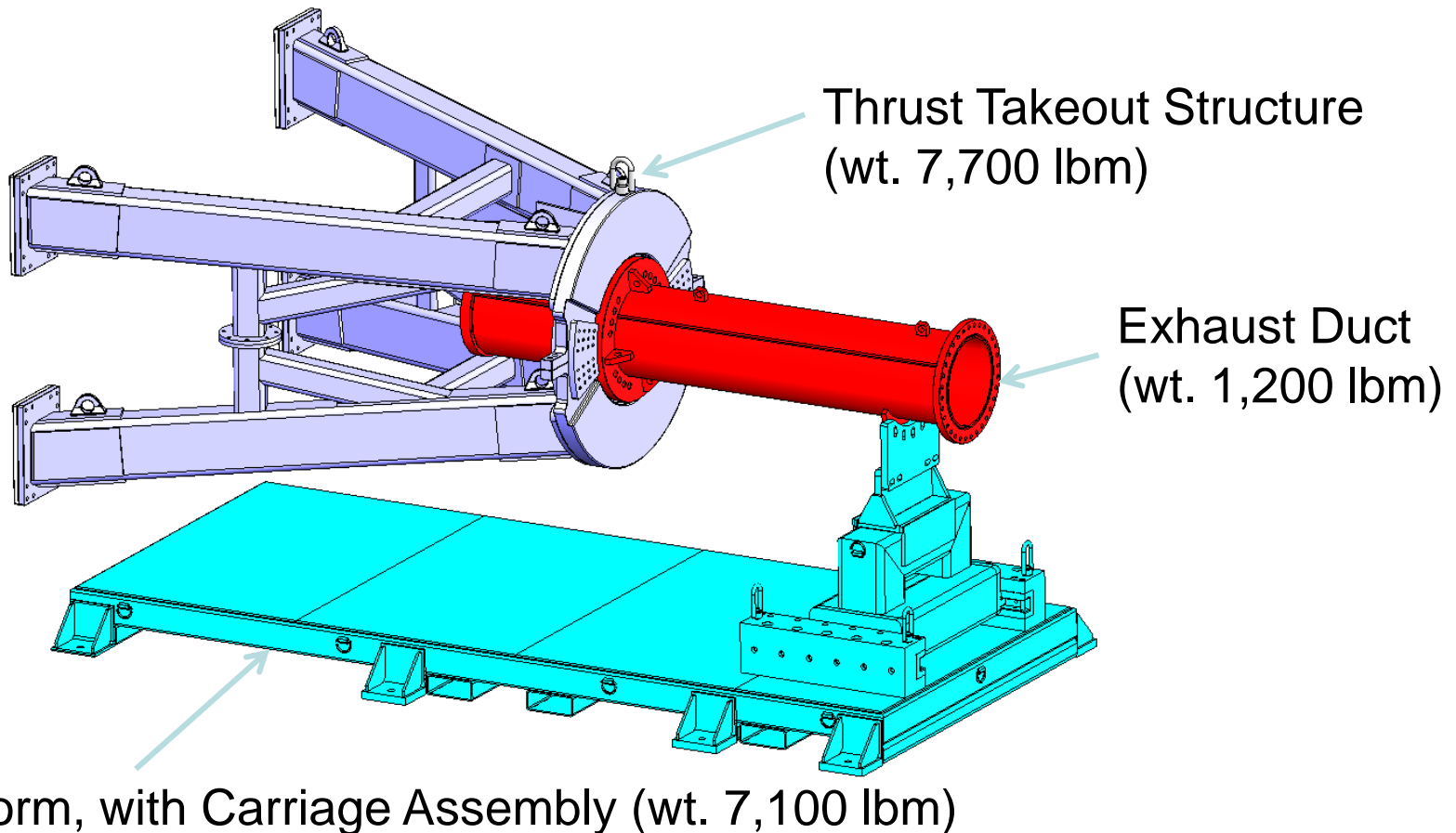

Test Skid Assembly – Manufactured Thrust Takeout Structure





INTERNATIONAL
ASTRONAUTICAL
FEDERATION

Test Skid Assembly – Manufactured Exhaust Duct





INTERNATIONAL
ASTRONAUTICAL
FEDERATION

Test Skid Assembly – Manufactured Test Skid





Test Skid Assembly – Manufactured Carriage Assembly

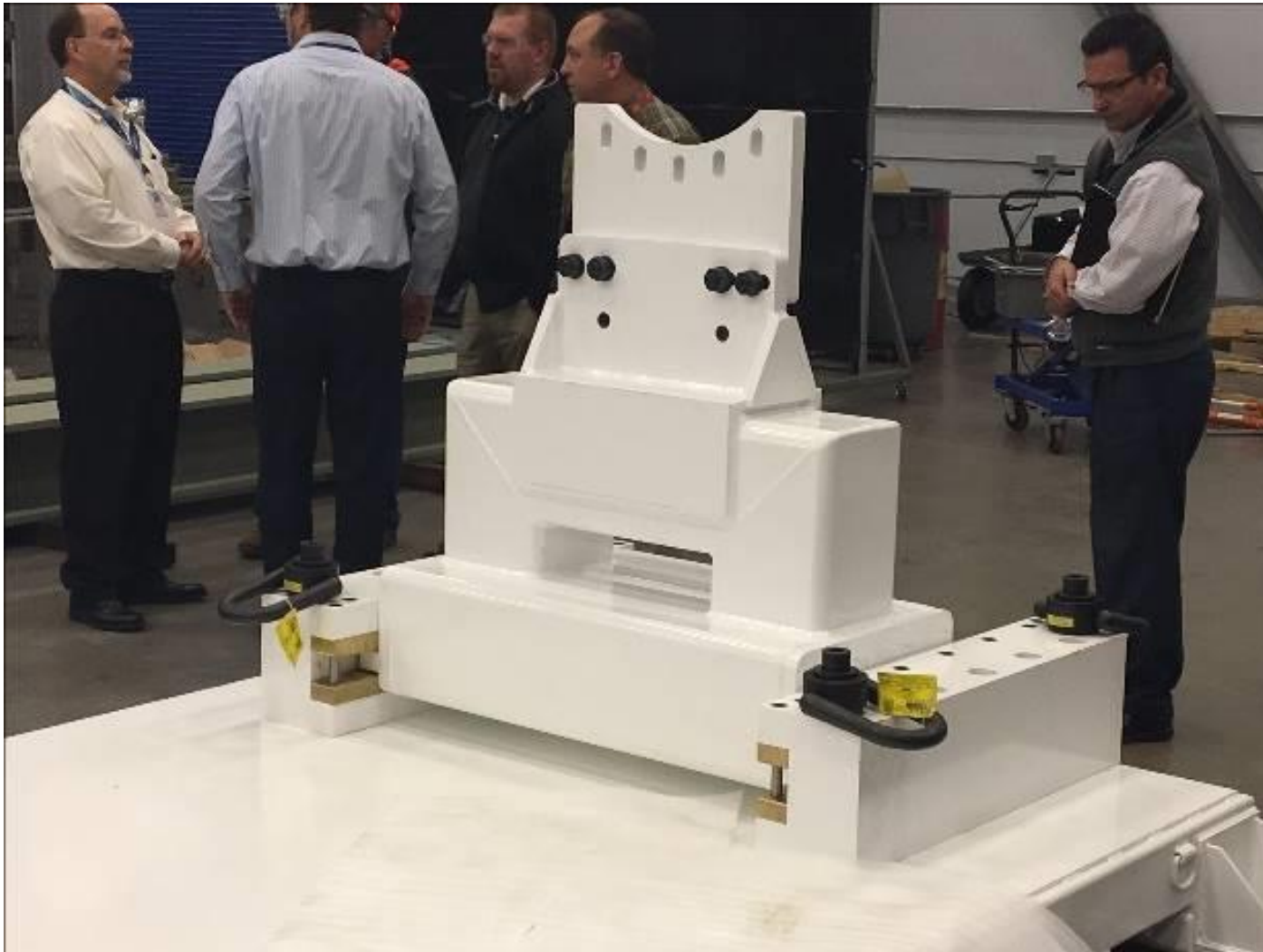



Testing at NASA Stennis Space Center Stand E1

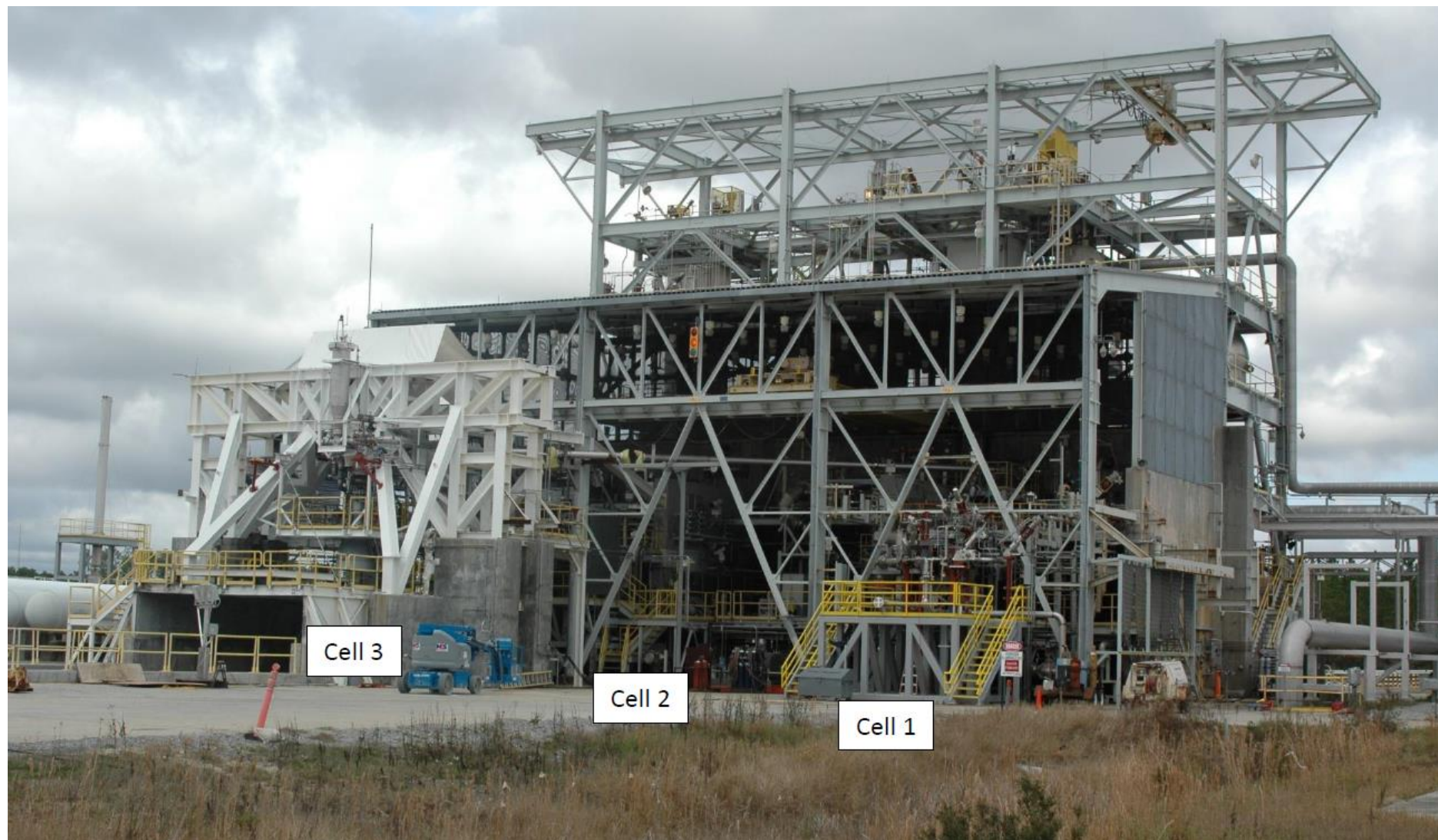



INTERNATIONAL
ASTRONAUTICAL
FEDERATION

NASA Stennis Space Center Stand E1 Overhead Crane Structure at E1, Cell 1





Test Schedule Summary

- **High thrust, LOX/kerosene rocket engine test facilities are rare, so the capabilities at NASA SSC's E1 test stand are in high demand**
 - Start of ABEDRR testing has been delayed by the use of the of the same test cell by another engine test program
 - In addition, there are other engines to be tested in other cells at E1 that overlap with preburner and ABEDRR testing
 - Limited SSC personnel and physical resources available for testing at E1
 - Test plans have been stretched to accommodate resource availabilities
- **E1, Cell 1 is expected to be available by Fall 2017**
- **Skid assembly and ICs are installed, 1st GFE preburner ready: early 2018**
- **Reconfigure for testing 2nd preburner; continue through late 2018**
- **Dual preburner testing through early 2019**
- **Then configure to accommodate main injector and TCA**
 - Conduct testing to demo combustion stability and measure performance
 - Planned to continue through end of 2019



Summary

- **Dynetics has designed innovative structure assemblies; manufactured them using FSW to leverage NASA investments in tools, facilities, and processes; conducted proof and burst testing, demonstrating viability of design/build processes**
- **Dynetics/AR has applied state-of-the-art manufacturing and processing techniques to the heritage F-1, reducing risk for engine development**
- **Dynetics/AR has also made progress on technology demonstrations for ORSC cycle engine, which offers affordability and performance for both NASA and other launch vehicles**
 - Full-scale integrated oxidizer-rich test article
 - Testing will evaluate performance and combustion stability characteristics
 - Contributes to technology maturation for ox-rich staged combustion engines

