



xPGS

EVA Technology Workshop 2017

October 17, 2017

Amy Ross

JSC/Space Suit and Crew Survival Systems Branch

Agenda



- Overview of Architecture
 - xEMU and xEMU Lite
- Relevant Pressure Garment Development History
 - Mark III, I-Suits, D-Suit, CxP Demonstrator, Z-1, Z-2
 - Suit testing
- Component Details
 - Description and rationale
 - Development plan and schedule
- Technical Risks
 - xEMU Lite
 - xEMU

xEMU Lite vs xEMU



xEMU Lite
ISS Demonstration
and
Potential EMU Replacement

xEMU Lite	Feature	xEMU
4.3 psi	Operating Pressure	8.2 psi
LEO Microgravity	Design Environment	Deep Space Microgravity Surface
Upper Torso + Min. Lower Torso	Mobility	Upper Torso + Full Lower Torso
Scarred for future upgrade	Crew Autonomy	Graphical Display

xEMU
Deep Space EVA
For
Gateway and Mars Transit



Overview of xEMU PGS



- Includes:
 - Cis-lunar and lunar surface (via lunar kit) mission and environment requirements
 - High durability/cycle life
 - Dust tolerant EPG, bearings, and mechanisms

Feature	xEMU
Operating Pressure	8.2 psi
Design Environment	Deep Space Microgravity Surface
Mobility	Upper Torso + Full Lower Torso

Overview of xEMU Lite PGS



Feature	xEMU Lite
Operating Pressure	4.3 psi*
Design Environment	LEO Microgravity
Mobility	Upper Torso + Min. Lower Torso



- Includes:
 - Integrated comm system (ICS)
 - Biomed
 - Mechanical extra-vehicular visor assembly (EVVA)
 - Liquid cooling and ventilation system (LCVG)
 - Environmental protection garment (EPG) interfaces (for dust tolerance)

*exploration PGS components will be designed for 8 psi

PG Development History



- From 1989 until present a series of pressure garments have been designed, fabricated, and tested by the Advanced Suit Lab (ASL).
- The testing performed over this 28-year period informed the architecture decisions reflected in the xPG
- The architecture is extensible to surface exploration missions
 - Detailed design changes will be required
 - Especially with regards to dust and durability/cycle life

PG Development History cont.



- Primary pressure garments tested to inform xPG architecture
 - Mark III [1989/1992]
 - Waist-entry and rear-entry I-Suits [1997, 2005*]
 - *First use at Desert RATS field test, developed under
 - *D-Suit* [1997]
 - *Demonstrator Suit* [2010]
 - Z-1 [2011]
 - Z-2 [2016]

Mobility – Lessons Learned



60's

80's

90's

00's

10's

2016

Time

Common Architecture



- Mark III, I-Suits and Z-Suit have common upper torso geometries
 - Rear-entry
 - Hatch size and angle
 - Shoulder angles
- Walking mobility lower torso



Mars Suit Prototypes



Mark III



WEI-Suit



REI-Suit



Z-1



Z-2

Design variables evaluated



- Softgood versus hardgood upper torso construction
- 3-bearing vs 2-bearing hip
 - Hip ad/ab bearing feature
- Shoulder designs
 - 2-bearing, patterned convolute, 4-bearing



D- and Demonstrator Suits



- Represent more Apollo-like architectures
 - Softgoods construction
 - Cable-pulley shoulder
 - Cable-pulley hip
 - Bubble helmet at a flatter angle
- Demonstrator Suit also addresses crew survival design requirements
 - e.g. umbilical connector location



Extensive Testing



- Hundreds of hours of testing have been performed with these suit configurations in a variety of test scenarios and environment
 - A few significant examples are given
- As an overarching outcome, the tests have provided suit engineers with an understanding of the various benefits and issues associated with each joint system and architecture for various applications
 - This experience guided component selection for the xEMU architecture

Examples of Tests



- ‘Swim Off’ Test
- Planetary gravity translation and mobility tasks
- Mark III, I-Suit D-Suit photogrammetry
 - Isolated joint mobility
- Desert RATS
- Constellation
 - Vehicle ingress/egress
 - Seat ingress/dwell/egress
- Long duration/distance translation
 - Walk back, CO2 washout, PLSS Human-in-the-loop (HITL)
- Energy Mobility
- Z-2 Neutral Buoyancy Laboratory (NBL)

'Swim Off' Test



- Performed in 1990/1991
- Included Mark III, EMU, AX-5
 - AX-5 is an 'all-hard' suit architecture
- Was performed in the WETF
- Data collected:
 - Range of motion/photogrammetry
 - reach envelope
 - subjective comments and ratings
- Provided feedback on lower torso mobility and hard vs. soft elbow and knee components



Range of Motion Photogrammetry



- Upon delivery of the I-Suit and D-Suit, isolated joint range of motion testing was performed with those 2 suits and the Mark III
- This is one of several methods attempted to characterize suit performance.
- The method does not capture programming, functional ability, effort required, etc.



Partial gravity translation and mobility



- 2 '3-Suit' tests
 - Mark III, EMU, A7LB
 - Mark III, D-Suit, I-Suit
- Both $1/6^{\text{th}}$ and $1/3^{\text{rd}}$ g
- Utilized simulated rock surface
- Tasks include walk, run, lope, kneel, recover from a fall
- Allows observation of suit mobility in actual gravity environment



Partial gravity translation and mobility





Desert RATS



- Pressurized suited testing 1998-2007 [2008-2011 m/u suits or shirtsleeve simulations]
- Perform planetary surface tasks



Desert RATS



Desert RATS



Evaluated ability of suit configurations to perform anticipated science and surface system set-up and maintenance.

Provided schedule and fidelity goals for technology development, as well as a structure for collaborations.

Results informed technology gaps/ R&D investment and the validity of design requirement and operations concepts.



Constellation tests



- Looked at both EVA and crew survival activities and performance
- Provided the opportunity to understand unpressurized suit performance and issues
- Also provided the opportunity to revisit 'soft' designs such as in the Demonstrator
- Major additional tests included:



2007 Test Timeline

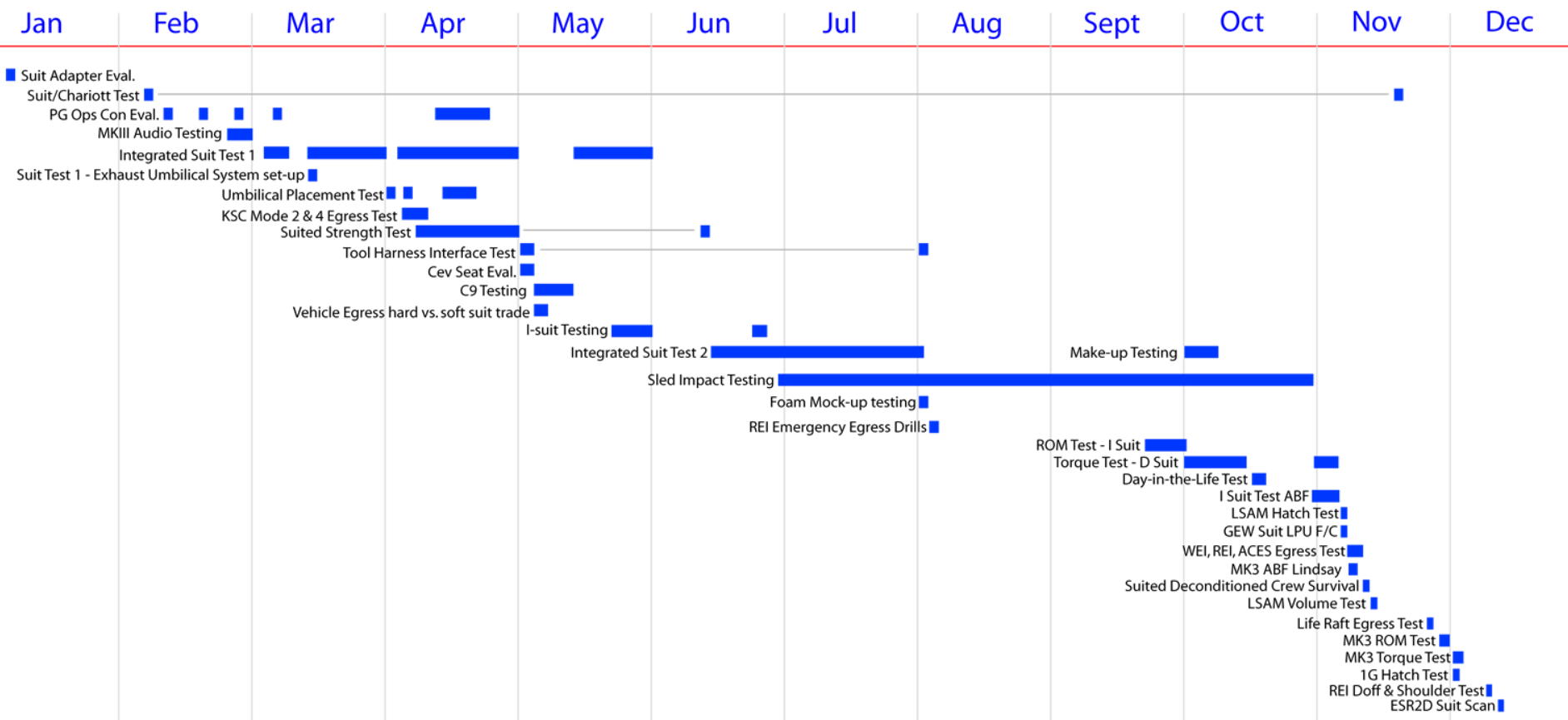

Tests Conducted by not shown on timeline:
 Air Force cold water survival (07 & 08 (4/08-TH & MD))
 Geological survey training (GT & AR)

Constellation



Constellation



Translation

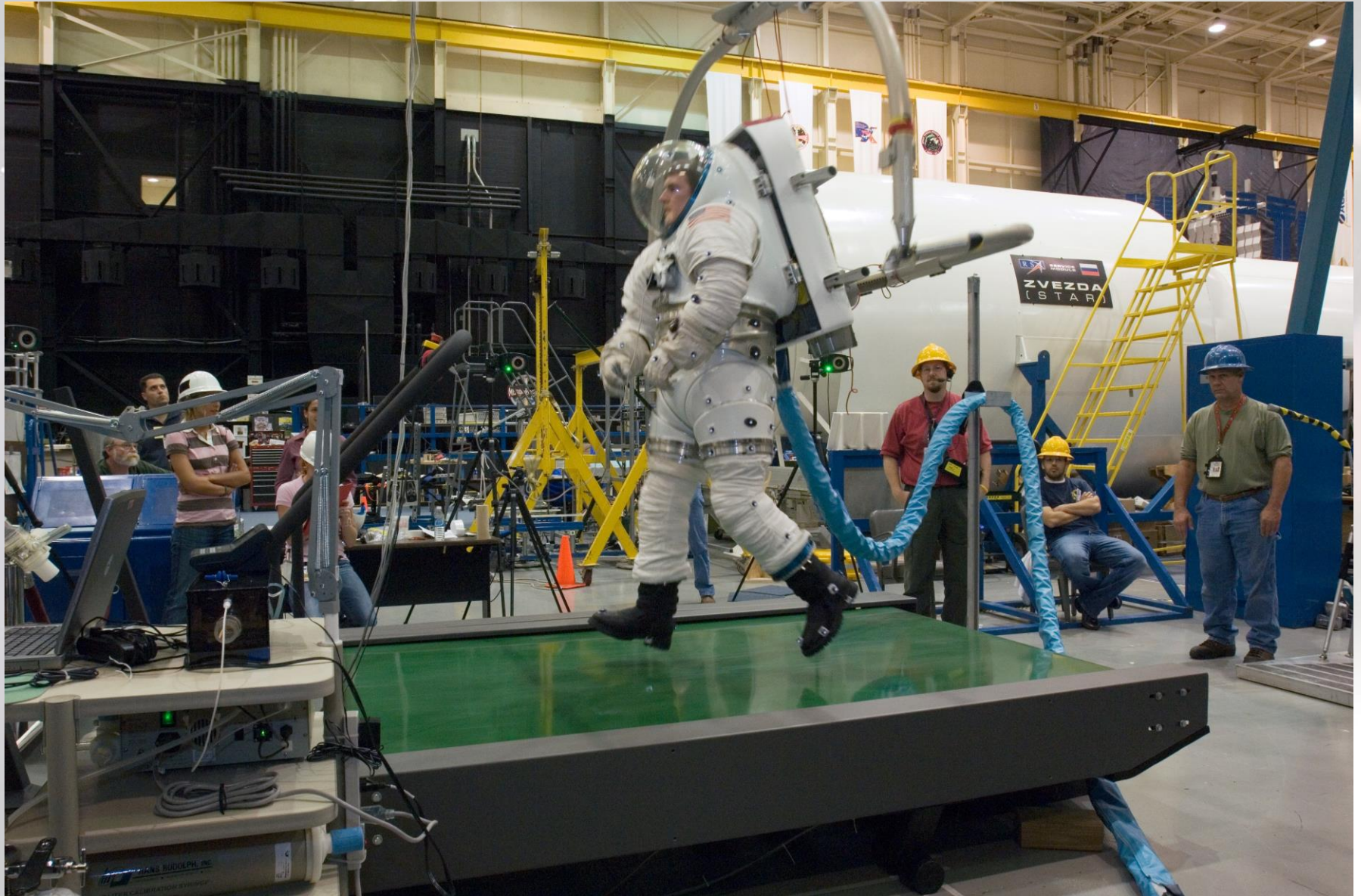

Translation



- Have supported translation tasks in 1-g, and both off-loaded and actual 1/6th-g, and 1/3rd-g
- Tests involving translation have included Desert RATS, boot testing, CO2 washout, PLSS HITL, and Walk back (10 km), and Energy Mobility
- Major observations:
 - Different gaits are utilized in different speed and gravity regimes
 - Leg lateral mobility is highly utilized during walking
 - A waist bearing enables a more natural walking gait
 - 2- and 3-bearing hip joint configurations provide good walking capability
 - Boot fit parallels glove fit in importance for walking

Translation-PLSS HITL



Energy Mobility



- A study to determine the feasibility of assessing suited mobility and requirements using functional tasks
 - Measured metabolic costs
- 5 tasks
 - Pilot test downselected to these tasks
 - 30 reps: walking, side step, stair climb,
 - 10 reps: upper body object relocation, full body object relocation
- While the method is promising, additional work is needed before application
 - Statistically relevant data
- Found that some subjects are relatively poor at rating Perceived Exertion so that it correlates to actual exertion

		Walking	Sitting	Stair Climbing	Prone/Kneel and Recover	Shoveling	Hammering	Object Relocation	Side Step
Mark III	A	VO ₂ (purple), VO ₂ <10% (teal)	VO ₂ (purple), VO ₂ <10% (teal)	VO ₂ /kg/rep (light purple), VO ₂ <10% (light teal)	VO ₂ (purple), VO ₂ <10% (teal)		VO ₂ (purple), VO ₂ <10% (teal)		
	B	VO ₂ /kg/rep (light purple), VO ₂ <10% (light teal)	VO ₂ /kg/rep (light purple), VO ₂ <10% (light teal)	VO ₂ /kg/rep (light purple), VO ₂ <10% (light teal)		VO ₂ /kg/rep (light purple), VO ₂ <10% (teal)	VO ₂ (purple), VO ₂ <10% (teal)	VO ₂ <10% (teal)	
	C	VO ₂ (purple), VO ₂ <10% (teal)	VO ₂ /kg/rep (light purple)	VO ₂ (purple), VO ₂ <10% (teal)	VO ₂ (purple), VO ₂ <10% (teal)				
Z-1	A					VO ₂ (purple), VO ₂ <10% (teal)		VO ₂ /kg/rep (light purple), VO ₂ <10% (teal)	VO ₂ /kg/rep (light purple), VO ₂ <10% (teal)
	B				VO ₂ (purple), VO ₂ <10% (teal)			VO ₂ /kg/rep (light purple)	VO ₂ /kg/rep (light purple), VO ₂ <10% (teal)
	C		VO ₂ <10% (light teal)						

Sample of test results from pilot study

Task video



Z-2 NBL Runs



- Performed 16 runs + 2 test prep
- Assessed configurations using the EMU lower torso and Z-2 lower torso with the Z-2 upper torso
- Assessed complex tasks, volume constrained task sites, and airlock ingress/egress
- Last two runs investigated airlock ingress/egress with reduced front-to-back suit dimension
- Major findings:
 - Improved upper body mobility and visibility
 - Reduce helmet bubble depth
 - Airlock ingress/egress required increased control over that needed for EMU
 - However, subjects were successful in all configurations
 - Mobile lower torso provided improved capability in most cases

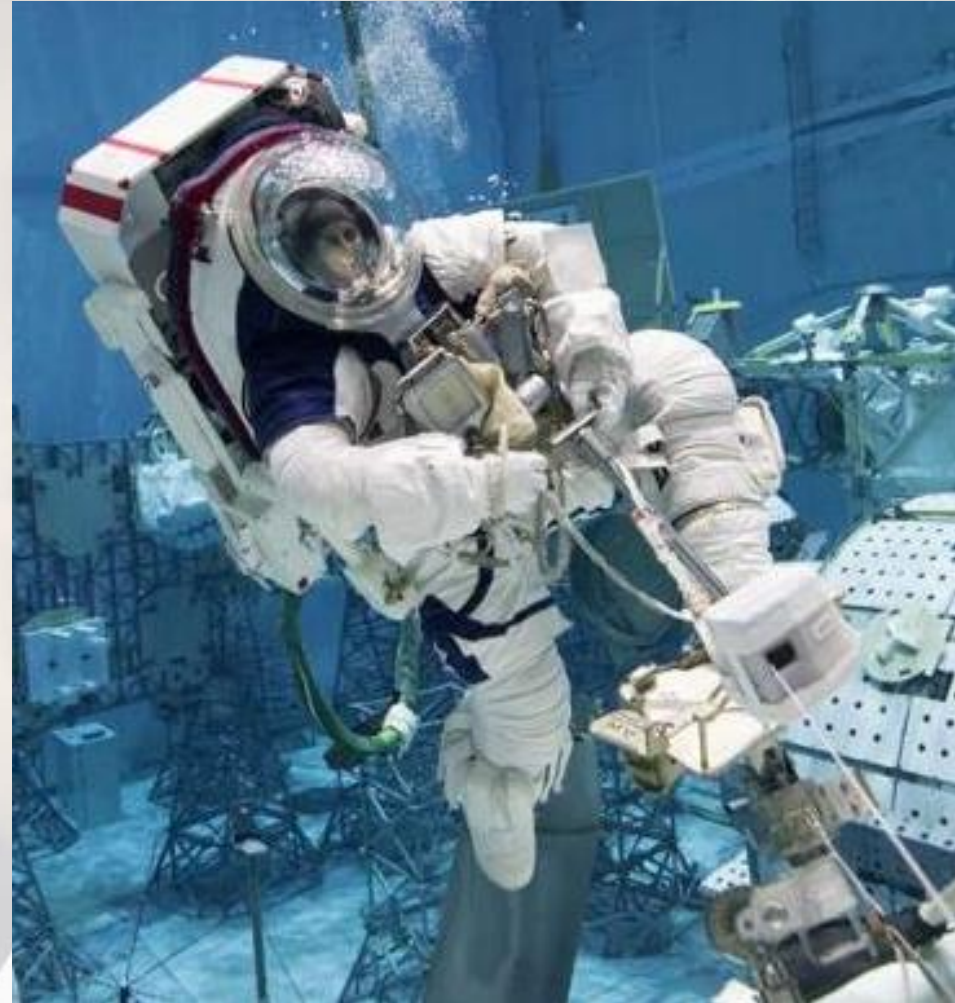

Z-2 NBL Runs

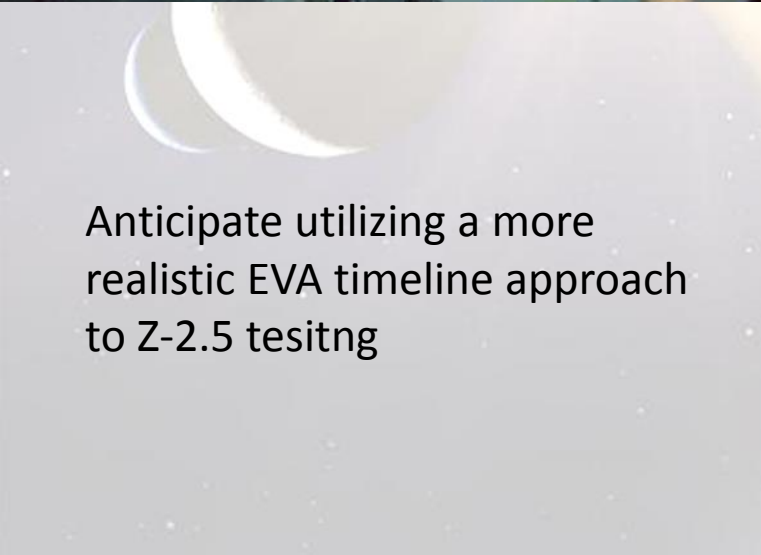
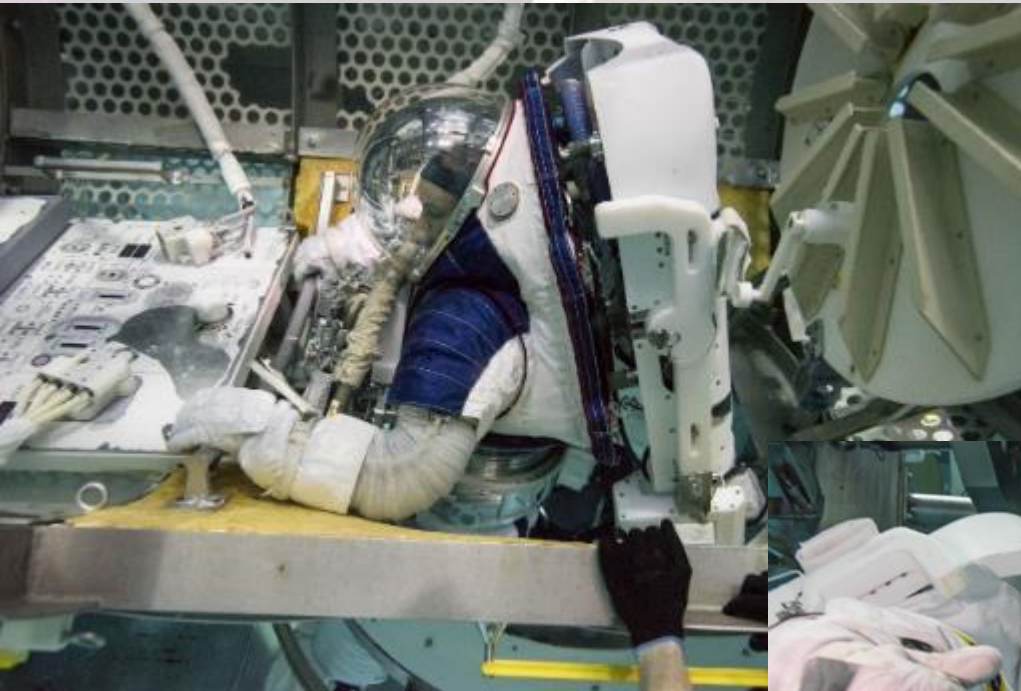

Anticipate utilizing a more realistic EVA timeline approach to Z-2.5 testing

Pressure Garment Components



- Upper Torso
- Shoulder
- Helmet
- Extravehicular visor assembly (EVVA)
- Integrated Communication System (ICS)
- Biomed
- EPG
- Liquid Cooling and Ventilation Garment
- Low-flow purge valve
- Ancillary

Development Plan



Component-level Development



- In general, each of the components follow the same basic development approach
 - Design and fabricate prototype unit (Z-2.5); FY18
 - Z-2.5 is fabricated from Al
 - Test prototype unit; FY18-19
 - Component level and in Z-2.5
 - Update design based on test results FY19

[System PDR: Late FY19]

- Fabricate Design Verification Test (DVT)/Engineering Unit (EU) hardware; FY19-20
- Perform acceptance testing on DVT/EU unit; FY20-21
- Incorporate component into subsystem-level DVT/EU test; FY20-21

[System CDR: FY21]

Exceptions



- Dust mitigation efforts, including:
 - Environment Protection Garment (EPG) lay-up
 - Are attempting to include EPG interfaces into design
 - Dust tolerant mechanisms and connectors
 - Bearings, latches, locks, etc.
- LCVG development may span from now until DVT (no Z-2.5 unit)

Upper Torso



- Rear-entry
 - Provides improved placement of shoulder bearings to allow more natural shoulder movement and mobility
 - Limits stresses placed on shoulders during suit don/doff
 - Expect a reduction in incidence of shoulder injury

Waist Entry

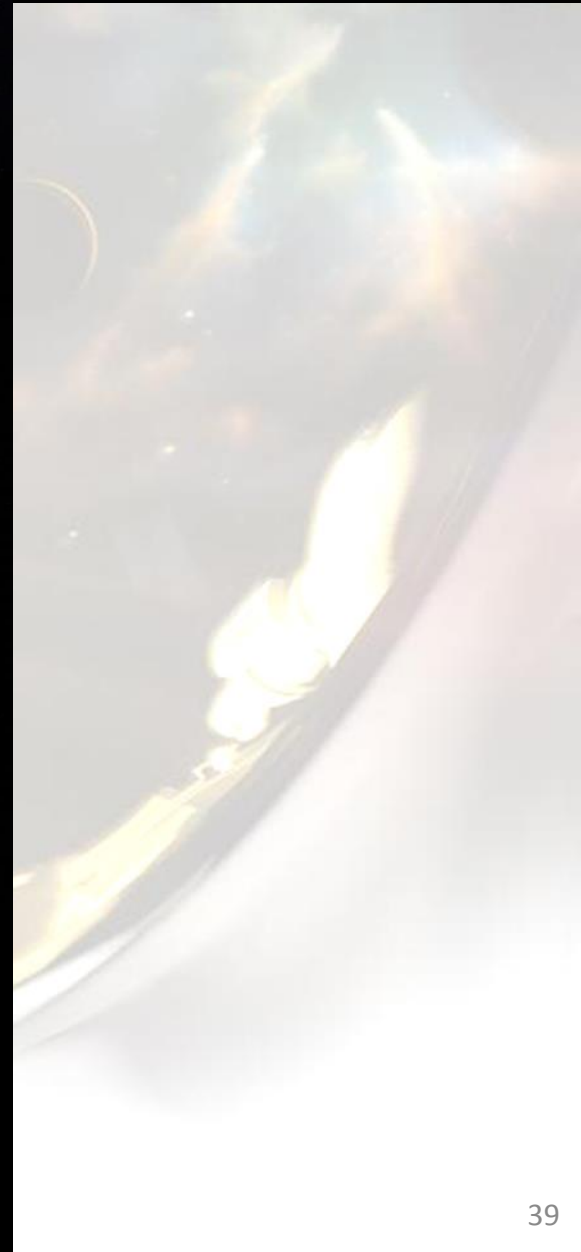
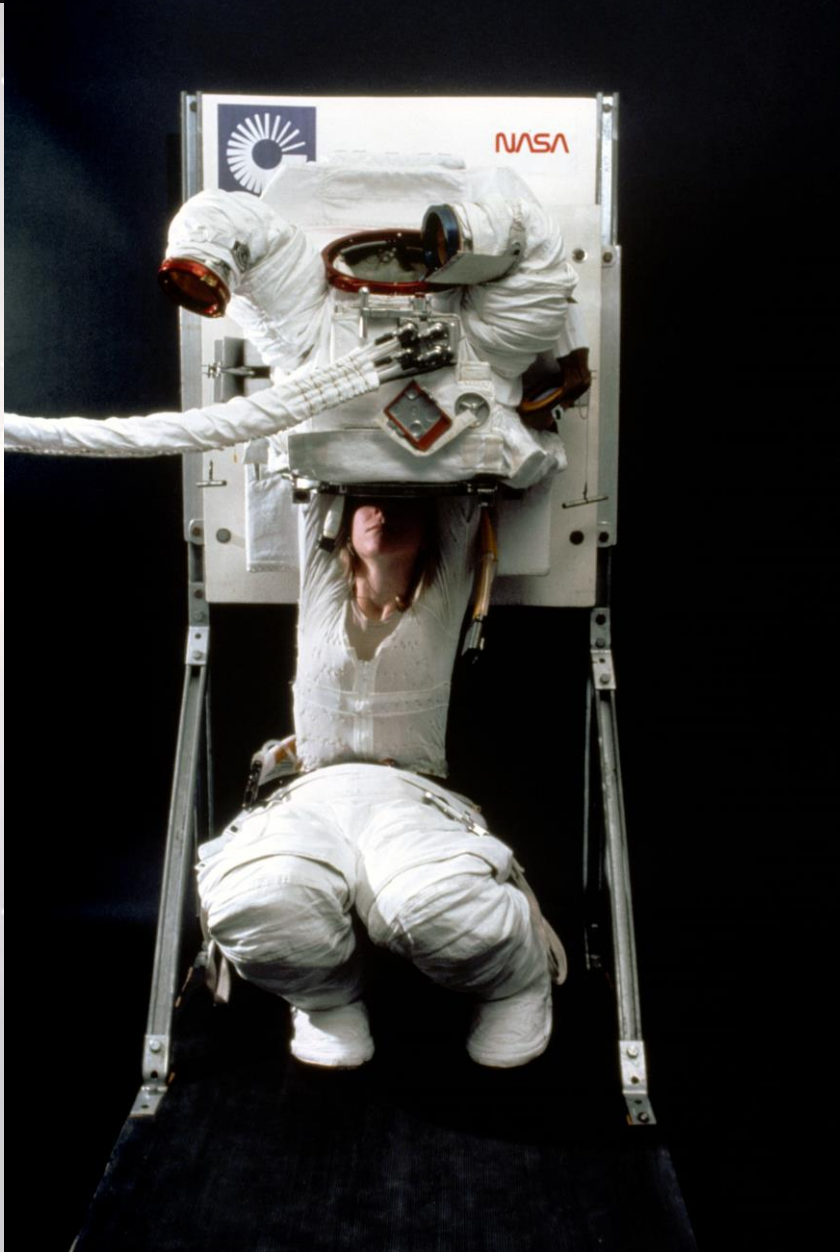

Rear Entry



Rear Entry Donning



Upper Torso



- Composite structure
- Shoulder harness
- Self don/doff
 - Goal for DTO
- Implementing geometry changes to reduce front to back dimension
 - Maintaining scye angles
- Increasing design fidelity with interfaces
- Incorporating additional fault tolerance
 - e.g. Secondary hatch seal
- Z-2.5 NBL testing will assess geometry changes
 - Impact on surface activities unknown until able to evaluate

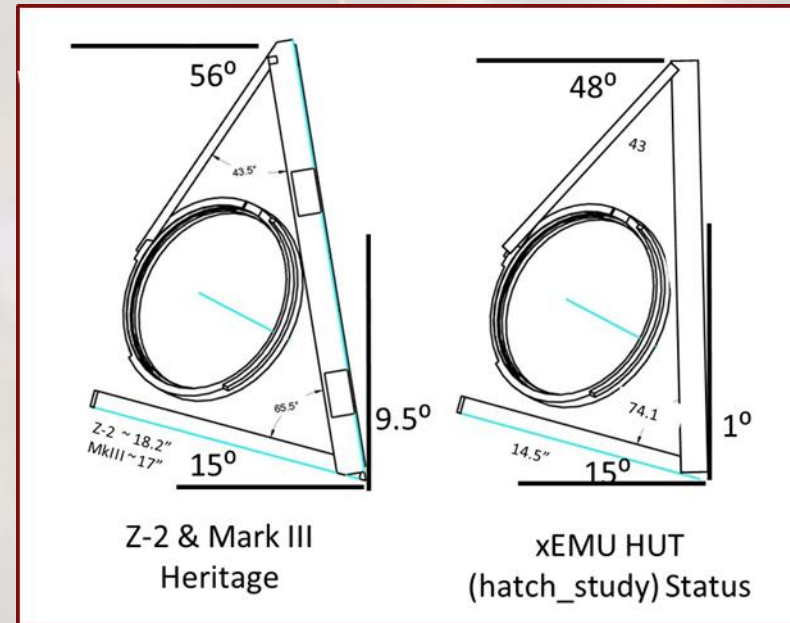

Shoulder



- Have tested more shoulders than any other joint
- Selected external link rolling convolute
 - Long history of performance
 - Mobility and durability
 - Will leverage recent design refinements
 - Performs well at 8 psi
- For Z-2.5 will re-use existing hardware
- FY18 scope includes kickload and impact analysis, but not test

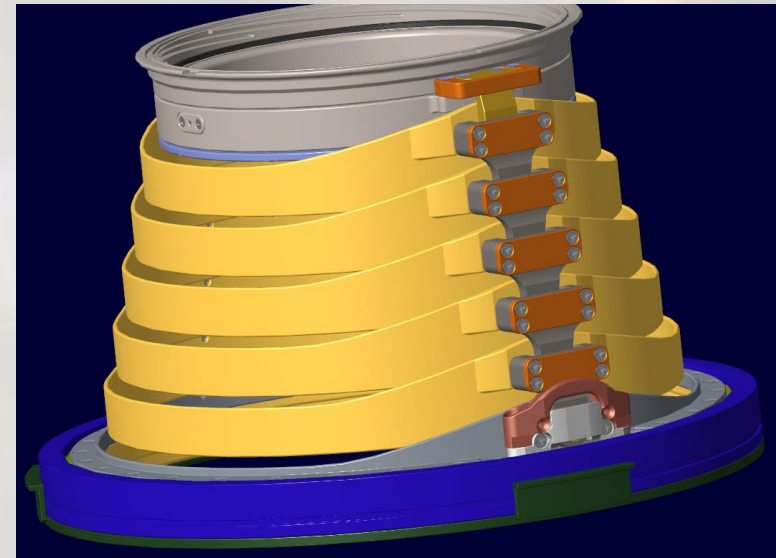

Helmet



- Includes pressure bubble, protective visor, male side of helmet disconnect, EVVA attachment features
 - 10" x 13" inner dimension
 - Considering shorter long axis
 - Managing depth to less than 8.5"
 - Z-2 was too deep at 9.2"
 - Bayonet-style locking mechanism to provide more reliable engagement
 - Low profile



Apollo/EMU helmet



Z-2 helmet

Helmet



- Selected shape is a hemi-ellipsoid with constant longitudinal radius
 - Provides increased visibility, especially downward, for walking on planetary surfaces
 - Testing to include kickloads and impact
 - FY18 scope is for analysis only

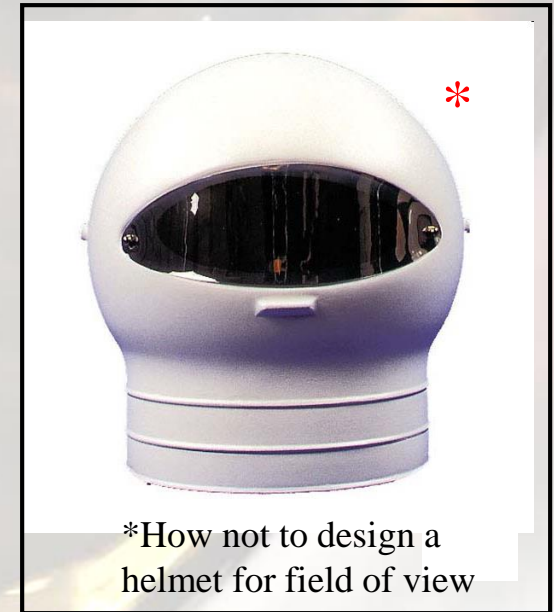

EVVA



- Includes outer shell, visor (tinted), shades (opaque), and coatings
 - Mechanical system can be realized in the DTO timeframe

- Visor

- Sectioned
 - Evaluating acceptability
- Provides 120° longitudinal field of view (FOV)
 - Determined during Z-2 NBL test
- Provides 160° peripheral FOV
 - EMU requires 170°
 - Reduction is caused by interference at the hinge

EMU EVVA

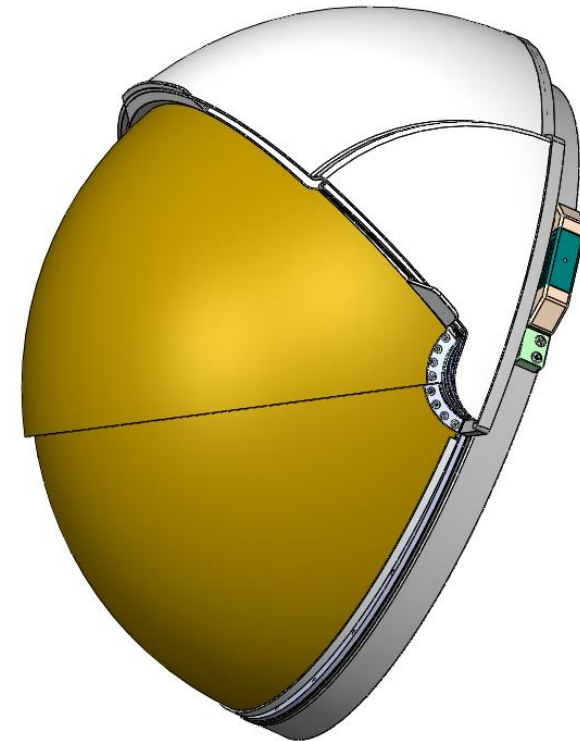

EVVA concept

- Testing includes impact and kickloads

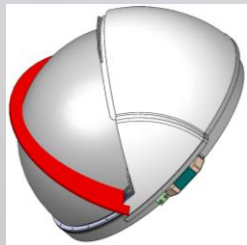

Integrated Communication System



- ICS removes the communication carrier assembly (CCA) from the head of the astronaut and places it onto the suit
 - Addresses many comfort and interference issues associated with the CCA
 - ICS design must address performance with head movement and ambient noise
 - ICS prototypes have been tested in the previous advanced prototype suits
 - Mics on neck ring, speakers in hatch
- Most recent, highest-fidelity system was included in Z-2 testing
 - Mics and speakers on neck ring
- ICS architecture will return to the mics on neck ring and speakers in hatch configuration



Z-2 ICS

Biomed



- SOA
 - Circa 1975 signal conditioner + wired electrodes
- Measure heart rhythm
 - Sole physiological monitoring requirement for PGS
 - Required signal quality is an open issue
 - Goal of moving the signal conditioner outside of the PGS
- Testing will include:
 - EMI
 - Radiation



EMU Biomed Signal Conditioner



Environment Protection Garment



- Z-2.5 cover layer will be build in house
 - HUT and shoulders
- Development focus is on dust tolerant EPG interfaces
 - Both adherence and penetration/permeation
 - Developing test methology
- Current scope likely precludes new EPG material lay-up for DTO
 - Can use EMU TMG lay-up
 - Research and development will continue at a low level
 - SBIR/STTR on materials and coatings

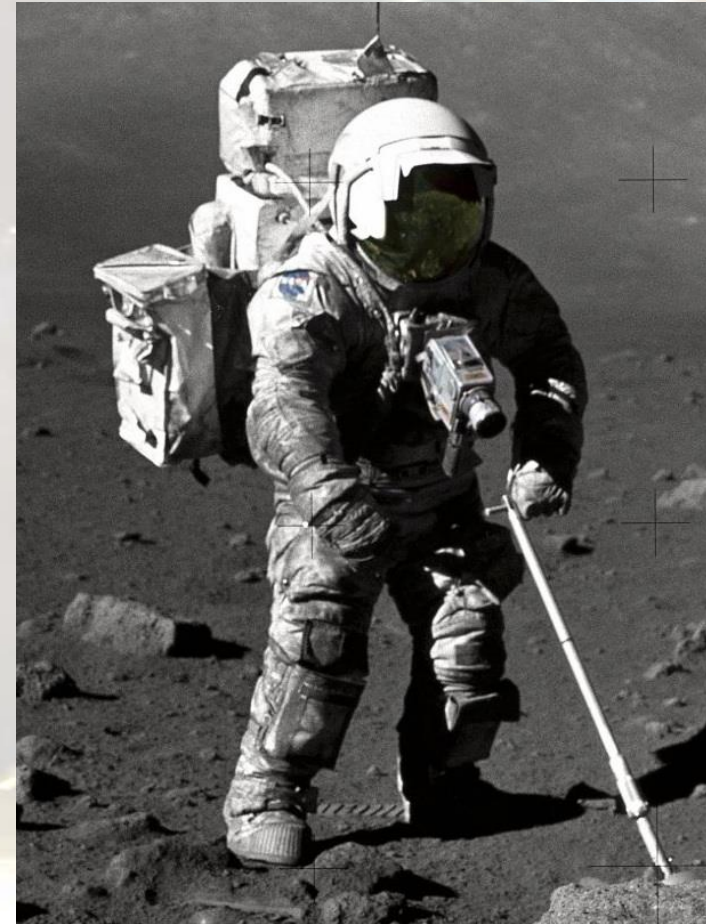

Dust Tolerant Mechanisms



- FY18 scope includes:
 - Refine bearing dust tolerance test method and testing hardware
 - Evaluate of current dust tolerant prototypes
 - Develop modular bearing dust mitigation concept test set-up
 - Commercial bearings in housings that incorporate dust mitigation features
 - Incorporate lessons learned

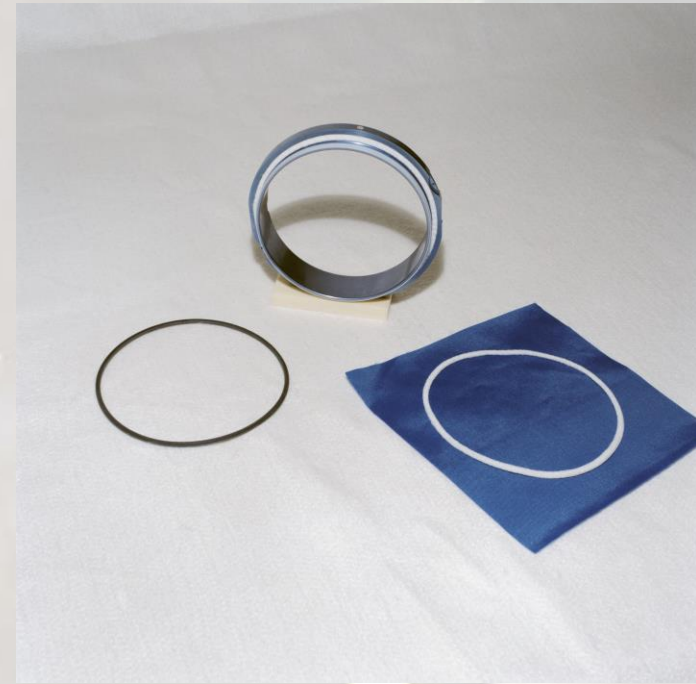

Liquid Cooling and Ventilation Garment



- FY18 scope is being determined
 - Test available prototypes
 - Design auxiliary multiple water connector
 - Determine if:
 - limited modifications (within budget and schedule) could create an acceptable Z-2.5 test article
 - Or if development for more involved design effort will be undertaken over FY18 and 19 to meet DVT testing

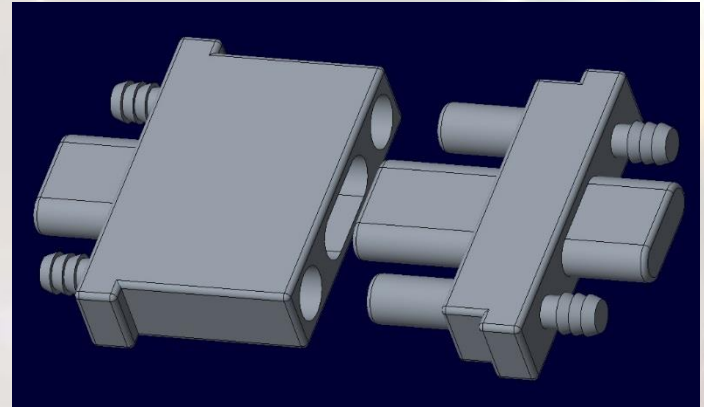

Low-flow Purge Valve



- FY18 scope is to define the interface
 - Location and physical interface
 - Model oral/nasal pickup if required

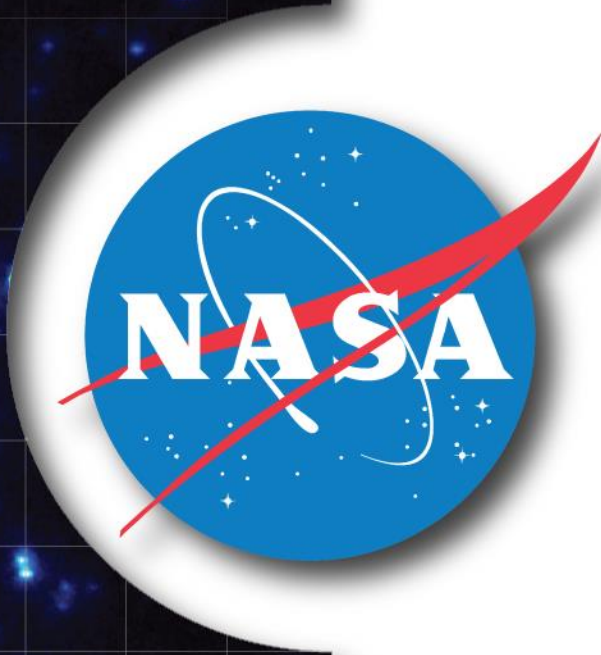
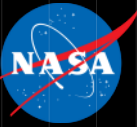

BACK UP

