



Application for Freeform Optics at NASA

Garrett J. West, Joseph M. Howard
NASA GSFC

EPIC Freeform Workshop



1. Motivation

2. Applications

A. Astrophysics 2020 Decal Survey

- LUVOIR mission
- OST mission

B. Earth Science: SAFE mission

C. Planetary Science: TIMERS instrument

D. CubeSats: XY Penta testbed



- ◆ NASA Scientists are often constrained by limited budgets and hence smaller instruments, but their expectations are unconstrained!

- ◆ Advantages of using freeform surfaces in reflective telescopes:
 - Reduce Volume
 - Increase the Field of View
 - Improve Image Quality
 - Fewer the number of surfaces



- ◆ Astrophysics
- ◆ Earth Science
- ◆ Planetary Science
- ◆ Cubesat and Smallsat platforms for any science application



- ◆ Technology Area 8.1.3
 - **Wide Field of View Reflective Imager**
 - 30deg field of view with >60cm Aperture
 - 5deg field of view with >200cm Aperture
- ◆ Technology Area 8.2.1
 - Large optical mirrors
 - UV, Optical ,Infrared wavelengths
 - 6.5m-30m diameter
 - <25nm RMS Surface Figure
 - <20kg/m² areal density
 - <\$0.5M/m² cost

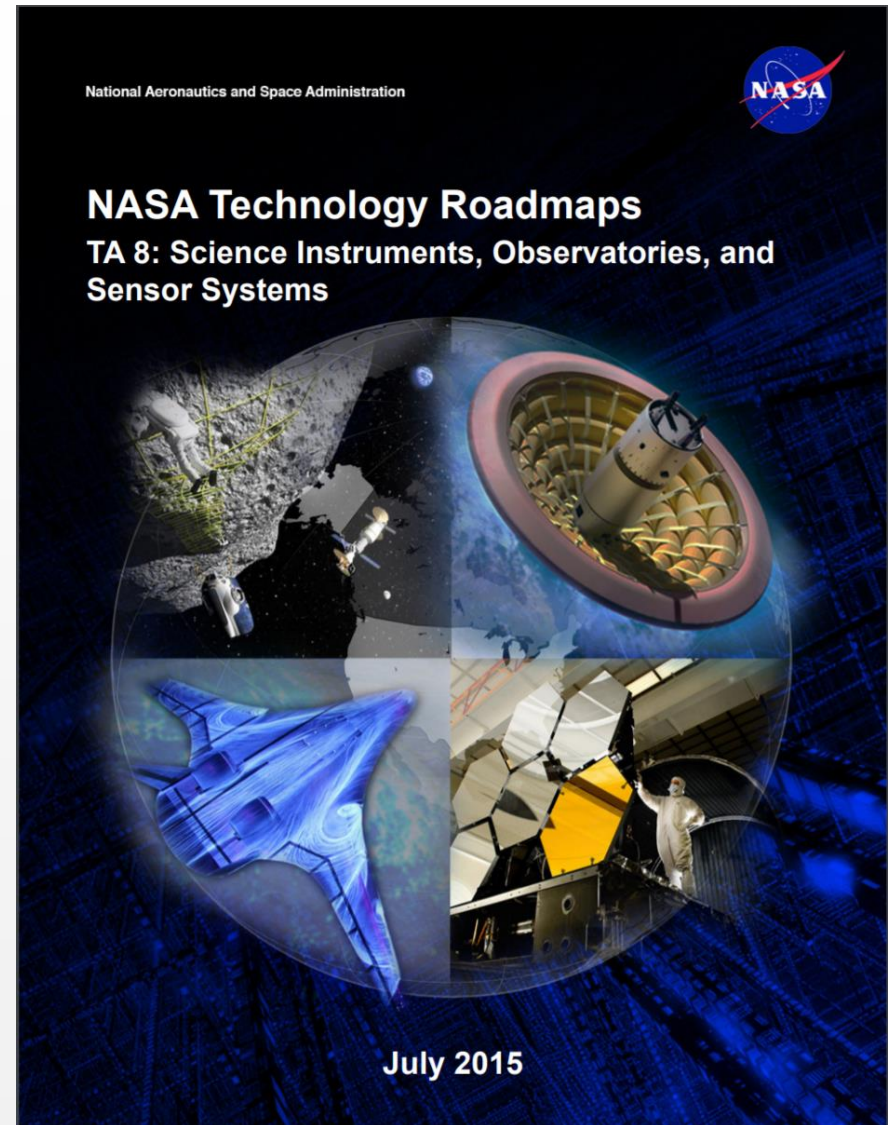

Leads to freeform applications



ASTROPHYSICS

Decadal Survey Missions



1972
Decadal Survey
Hubble

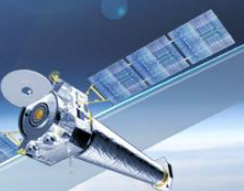

1982
Decadal Survey
Chandra



1991
Decadal Survey
Spitzer, SOFIA



2001
Decadal Survey
Webb



2010
Decadal Survey
WFIRST



2020
Decadal Survey



- ◆ NASA HQ selected four large mission concept studies started in Jan 2016 to prepare for Astro2020 Decadal Survey

**Potential
Freeform
Optics
Applications**

- **Large Ultra-Violet Optical Infrared Surveyor (LUVOIR)**
- Habitable Exoplanet Imaging Mission (HabEx)
- **Origins Space Telescope (formerly Far-IR Surveyor)**
- Lynx (formerly X-Ray Surveyor)

- ◆ LUVOIR and OST Study office at GSFC
- ◆ HabEx Study Office at JPL
- ◆ Lynx Study Office at MSFC



1. Motivation

2. Applications

A. Astrophysics 2020 Decal Survey

- **LUVOIR mission**
- OST mission

B. Earth Science: SAFE mission

C. Planetary Science: TIMERS instrument

D. CubeSats: XY Penta testbed

What is LUVOIR ?



Large UV / Optical / Infrared Surveyor (LUVOIR)

- ◆ A space telescope concept in tradition of Hubble
 - Broad science capabilities
 - Far-UV to Near-IR bandpass
 - ~ 8 – 16 m aperture diameter
 - Suite of imagers and spectrographs
 - Serviceable and upgradable*
 - Hubble-like guest observer program

Crab Nebula with HST
ACS/WFC
Credit: NASA / ESA

“Space Observatory for the 21st Century”
Ability to answer questions we have not yet conceived

Imagine astronomy without Hubble ...

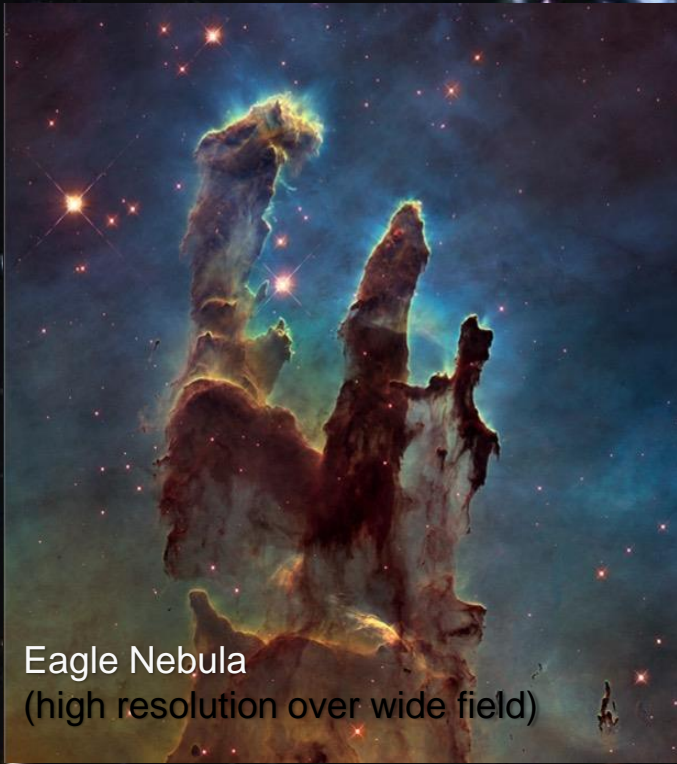

Eagle Nebula
(high resolution over wide field)



Hubble Ultra Deep Field
(ultra-deep imaging)



Jupiter's aurora
(UV, global monitoring)

Imagine astronomy with LUVOIR ...



Pluto with Hubble

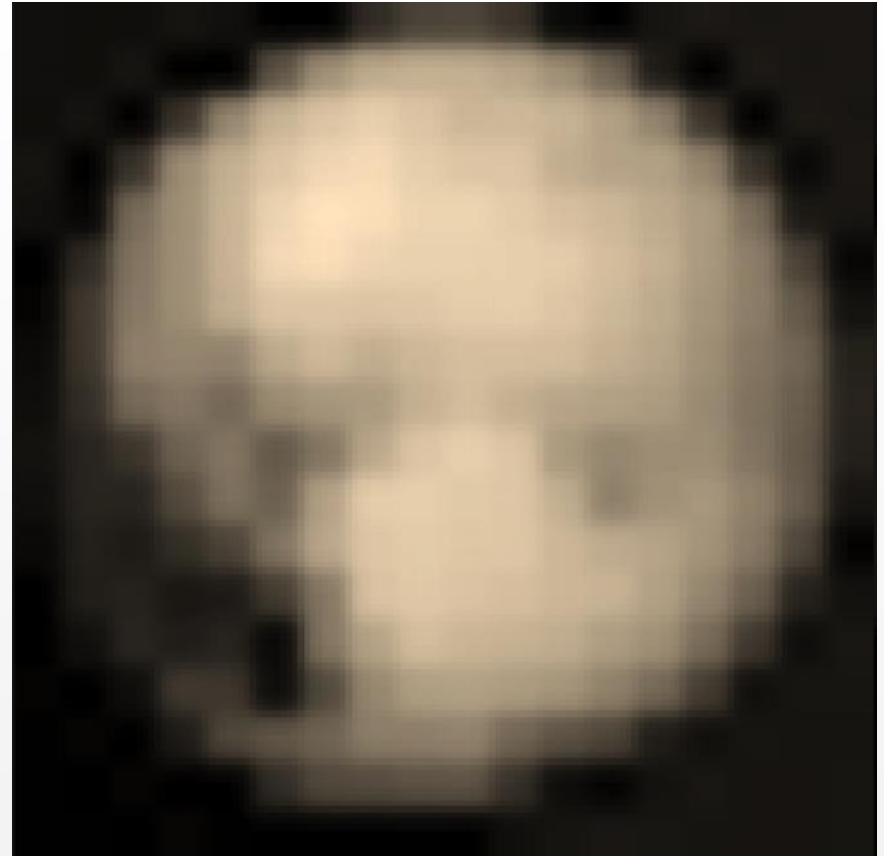

Pluto with 15-m LUVOIR

Credit: W. Harris (LPL)

Imagine astronomy with LUVOIR ...

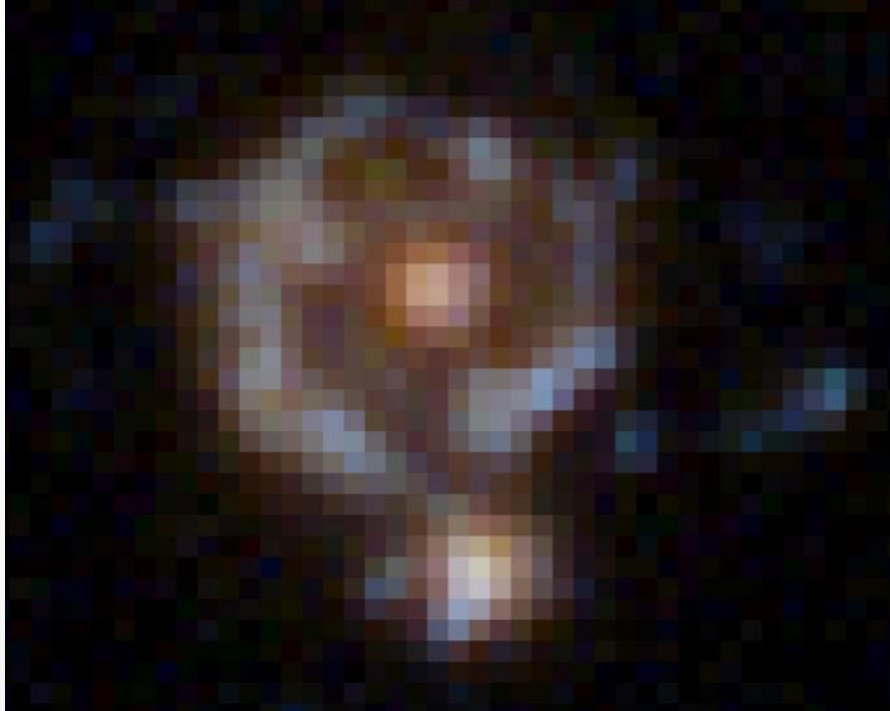

Galaxy at $z = 2$
with Hubble



Galaxy at $z = 2$
with 12-m LUVOIR

Characterizing Earth 2.0 ...



Solar System from 13 parsec
with coronagraph and 12-m telescope

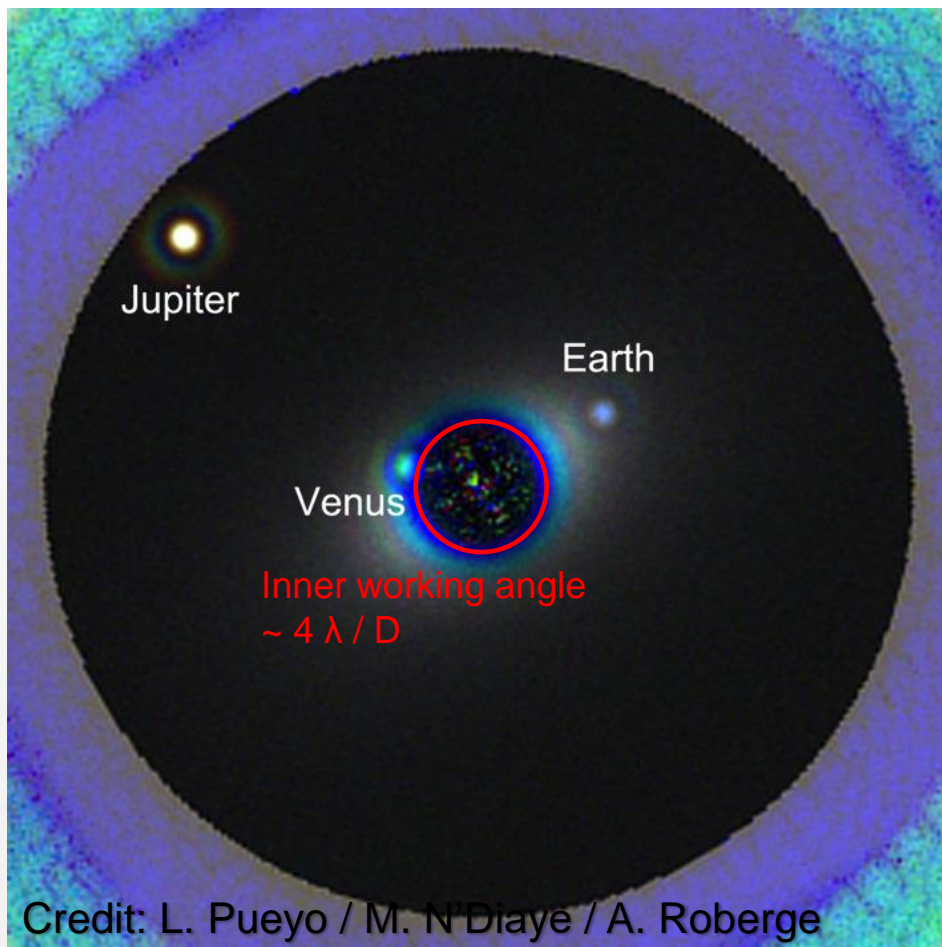

Characterizing Earth 2.0 ...



Solar System from 13 parsec
with coronagraph and 12-m telescope

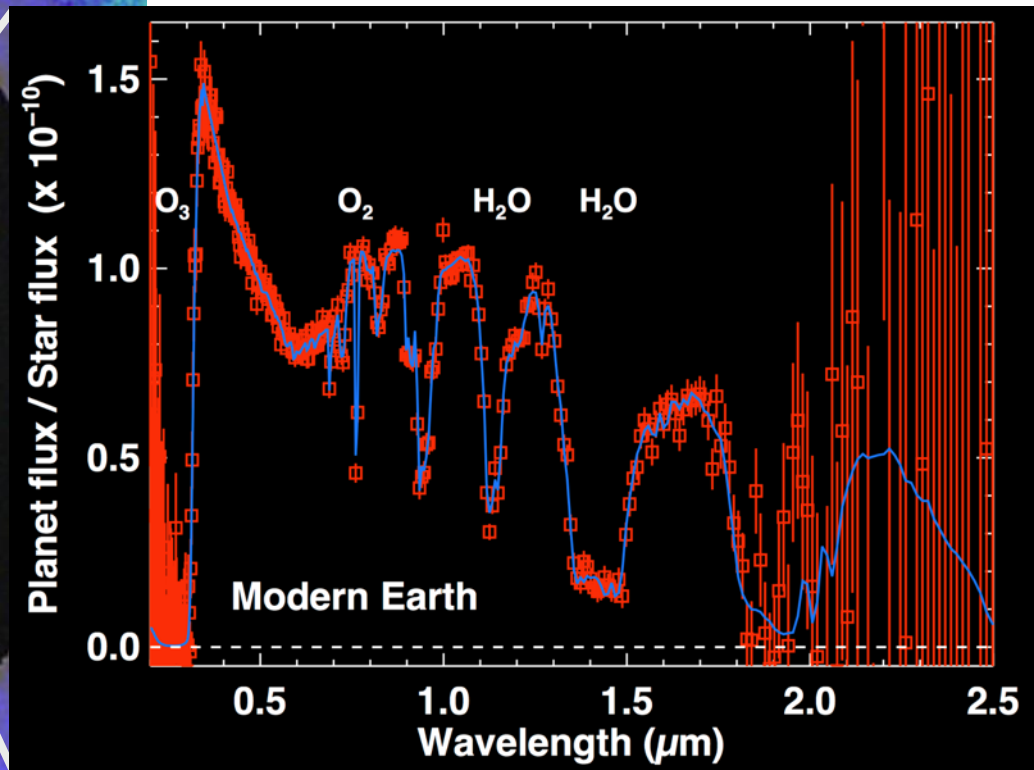
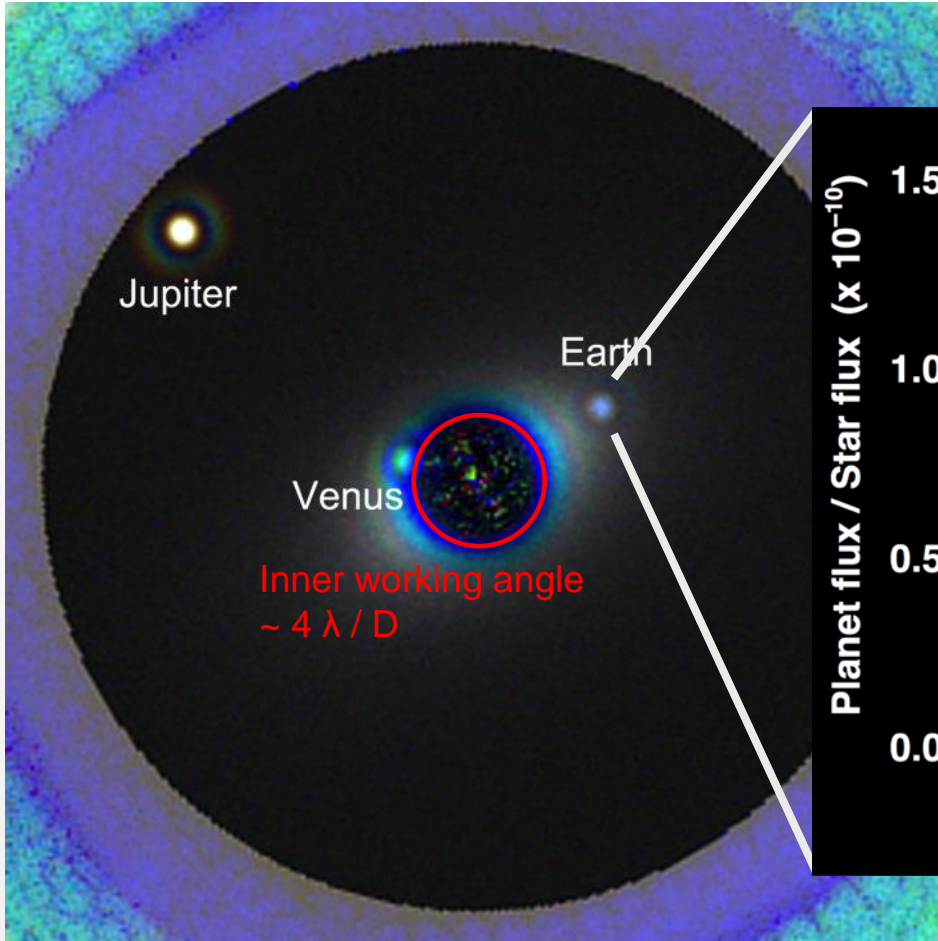

Credit: T. Robinson / G. Arney

Credit: L. Pueyo / M. N'Diaye / A. Roberge

Note: In this representation,
spacecraft & sunshield are
notional.

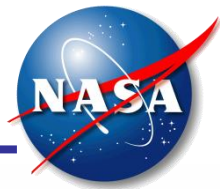

Deployment Video Here

“Yep, it’s big.”

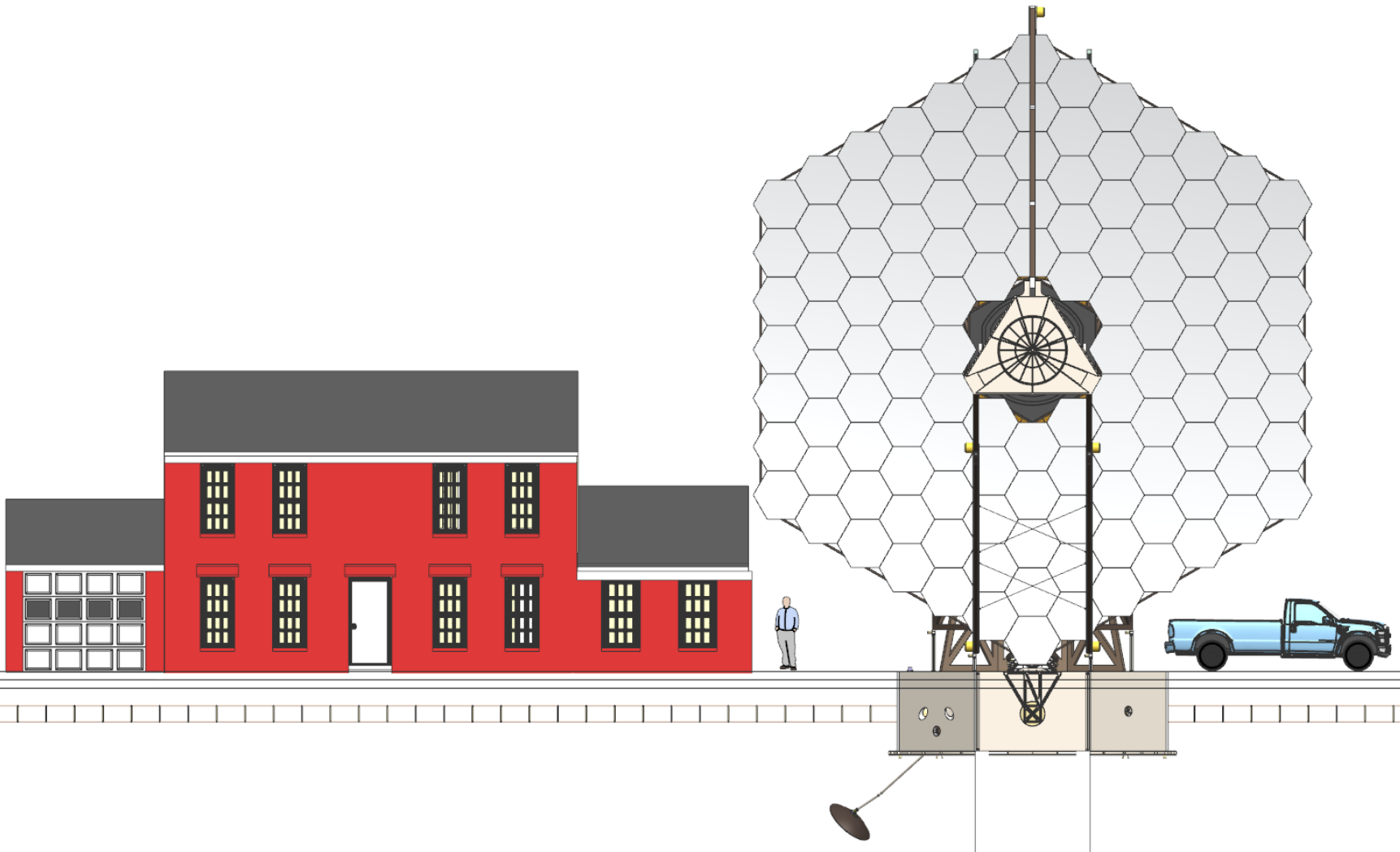



LUVOIR Instruments

1. LUVOIR Ultraviolet Multi Object Spectrograph (LUMOS)
 - Fewer mirrors
 - Throughput is limited by the Al coating reflectivity in the UV
 - Improve image quality in UV
 - Reduce volume for limited instrument package
2. Coronagraph
 - Correct aberrated off axis field from telescope
3. High Definition imager (HDI)
 - Correct wide field of view
 - Improve image quality in UV and VIS
 - Reduce volume and mass

NASA Needs: UV grade freeform mirrors and reflective gratings



1. Motivation

2. Applications

A. Astrophysics 2020 Decal Survey

- LUVOIR mission
- **OST mission**

B. Earth Science: SAFE mission

C. Planetary Science: TIMERS instrument

D. CubeSats: XY Penta testbed

Origins Space Telescope (OST)

- ◆ Far Infrared Wavelengths 6-600um
- ◆ 4k Telescope
- ◆ 9m Aperture unobscured TMA telescope
- ◆ 5 instruments including medium and high resolution spectrometers, coronagraph, imager and polarimeter

**Tracing the
Ingredients of
Life and the
Ingredients of
Habitable Worlds**



**Unveiling the
Growth of Black
Holes and Galaxies
Over Cosmic Time**

**Charting the
Rise of Metals,
Dust, and the
First Galaxies**

**The Solar
System in
Context**

Ingredients of Life



Following the trail of life-bearing water from the interstellar medium to habitable worlds*



OST will trace water prior to star formation in dense cores

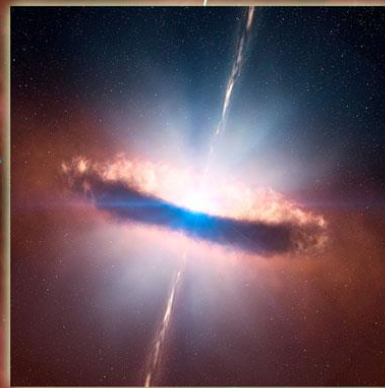

OST will follow the trail of water into nascent planet-forming disks

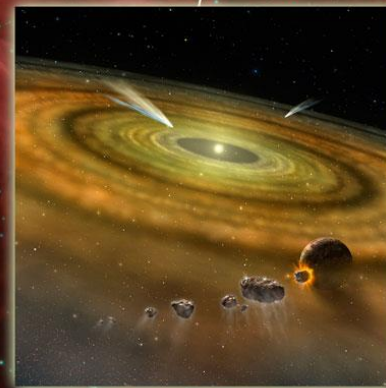

OST will survey thousands of disks and reveal the statistical disposition of water around stars of all masses during planet formation

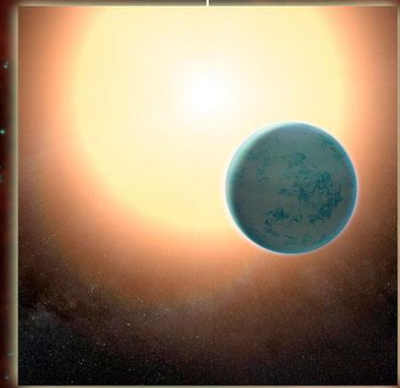

OST will set distinct constraints on planetary habitability by detecting water and biomarkers on rocky planets in habitable zones

Exoplanet Biosignatures



Find conclusive evidence of the presence or absence of a life signature on at least ten exoplanets.

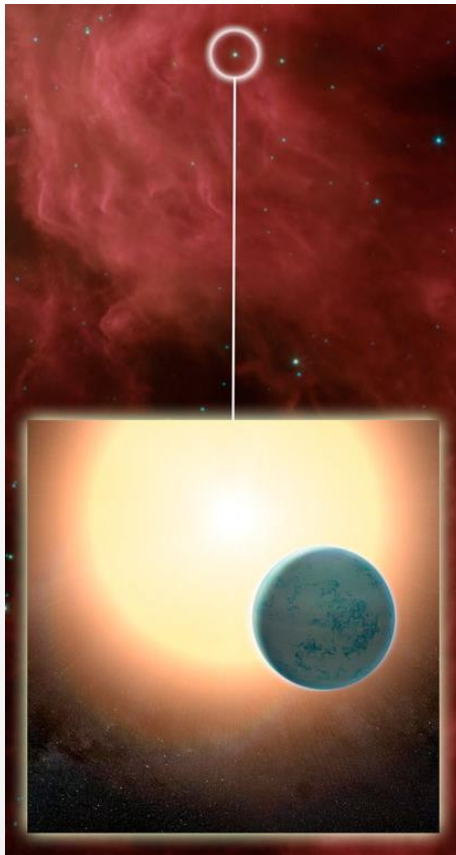

- Transiting exoplanet spectroscopy
- Technique pioneered with Spitzer Space Telescope
- Key biomarkers accessible in the mid-infrared

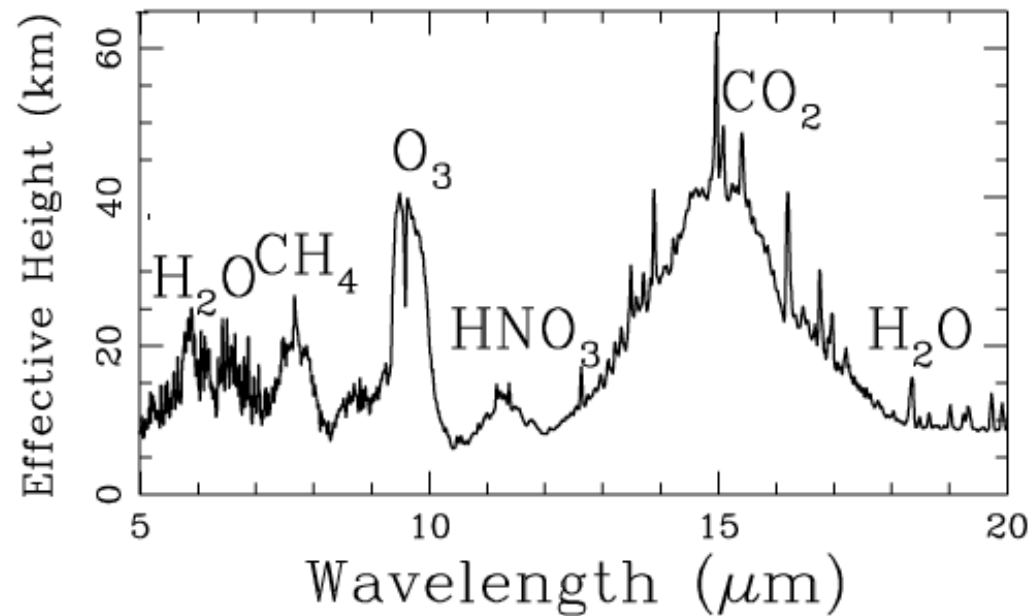

Huge Gain in Sensitivity

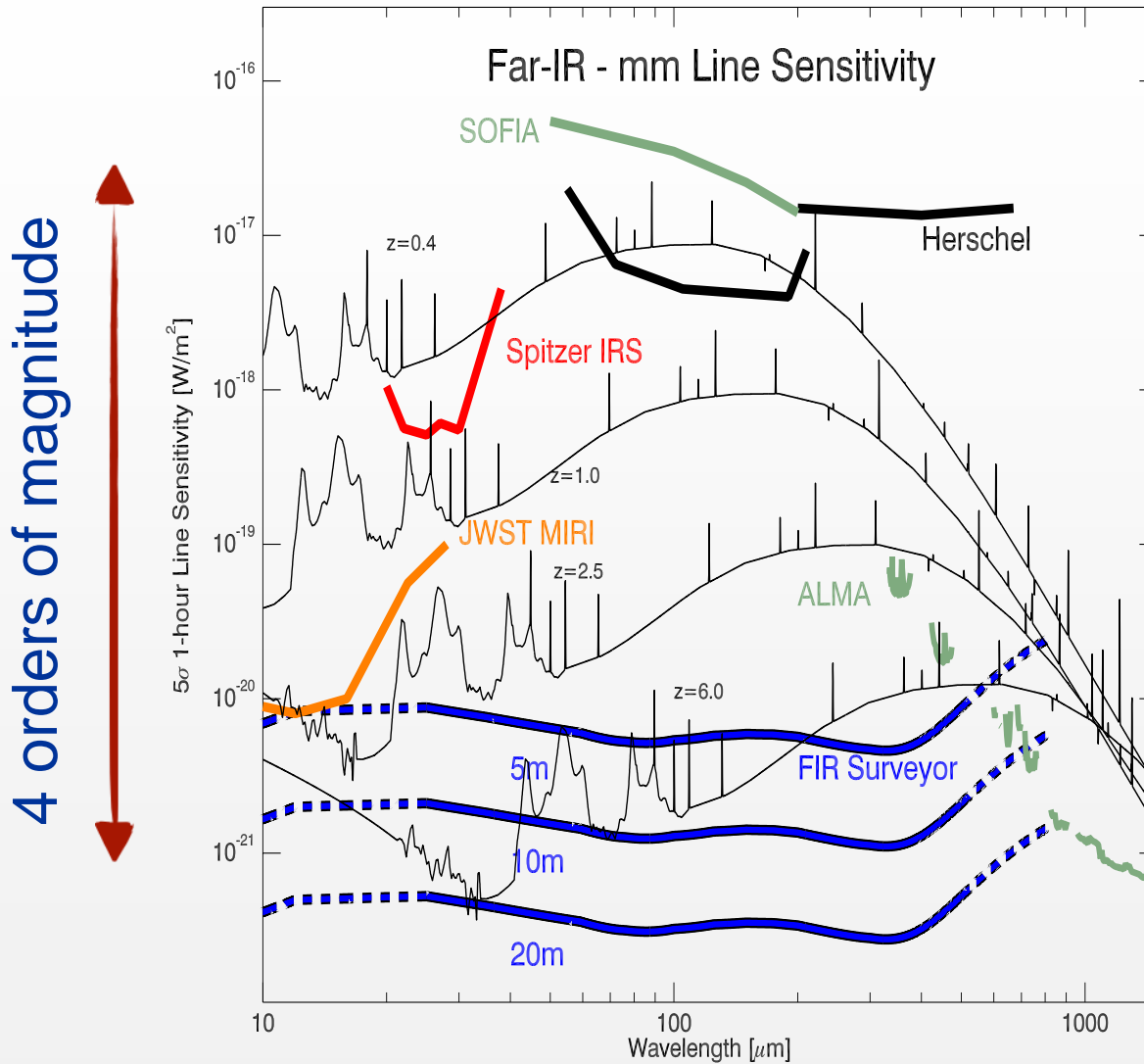

Deployed Observatory

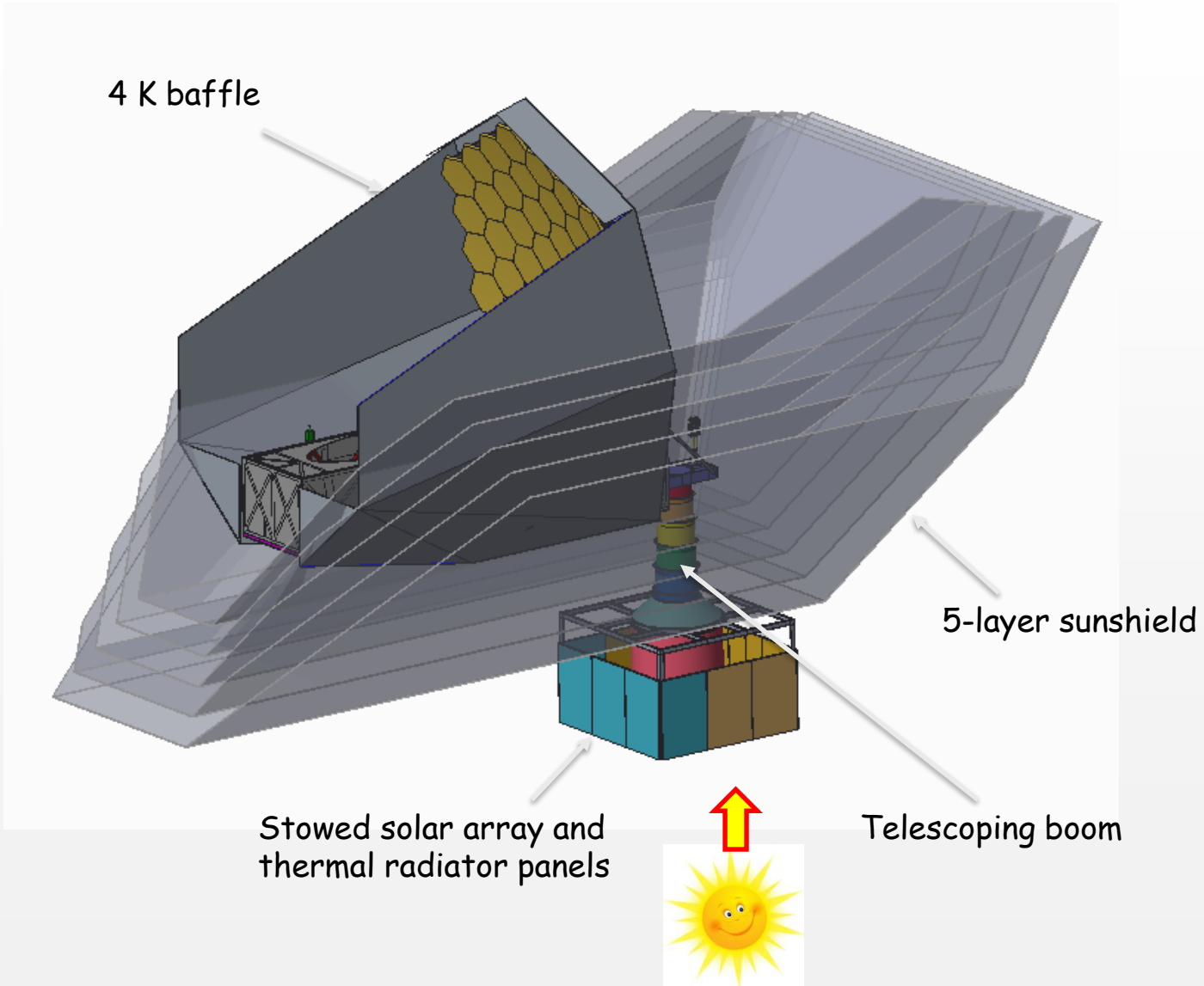
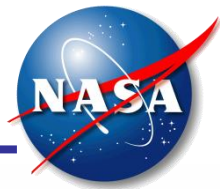

Instrument Module

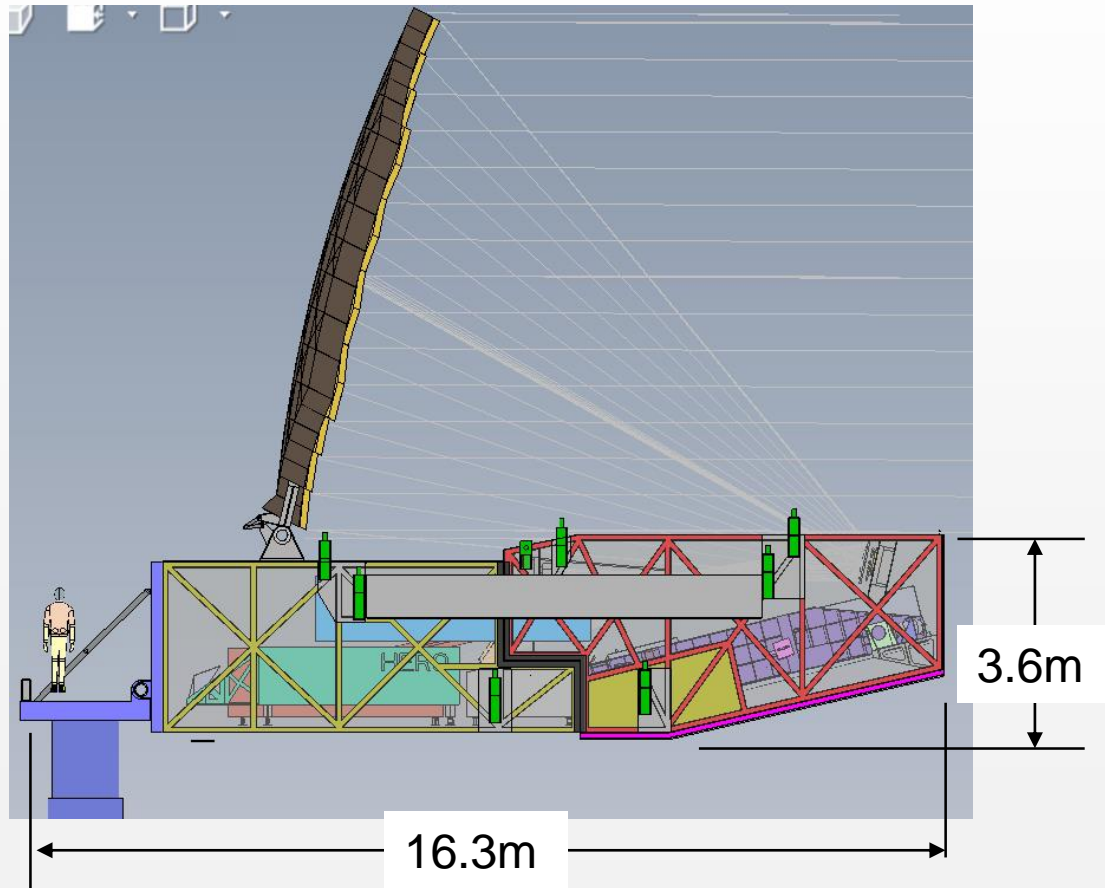
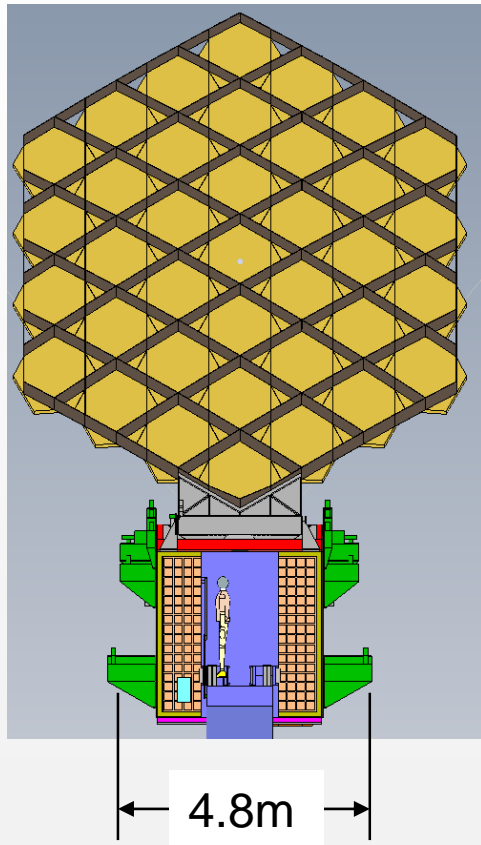

OST Freeform Applications



- ◆ **Freeform mirrors** help correct **aberration** caused by constrained mirror locations to be within packaging volume due to the folded telescope design architecture
- ◆ **Freeforms** are used to correct aberration over **wide field of view**

NASA Need: large cryo-stable freeform mirrors



1. Motivation

2. Applications

A. Astrophysics 2020 Decal Survey

- LUVVOIR mission
- OST mission

B. Earth Science: SAFE mission

C. Planetary Science: TIMERS instrument

D. CubeSats: XY Penta testbed

Structure and Function of Ecosystems (SAFE)

- ◆ Constellation of paired high resolution imager and spectrometer instruments
- ◆ Diurnal measurements at three times per day
- ◆ Capture vegetation functional response to environmental conditions.
- ◆ Visible wavelengths 450-1630nm

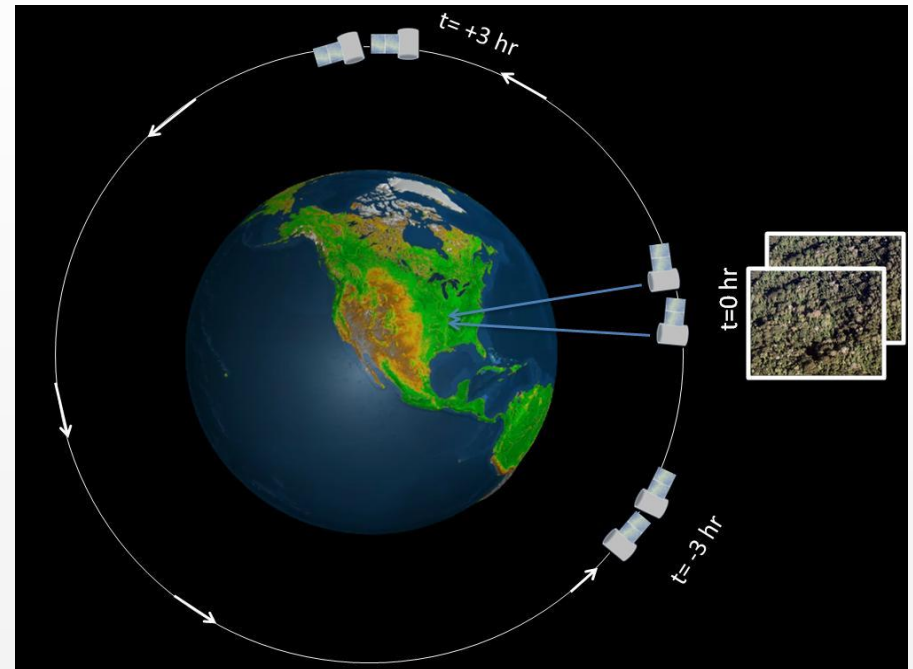

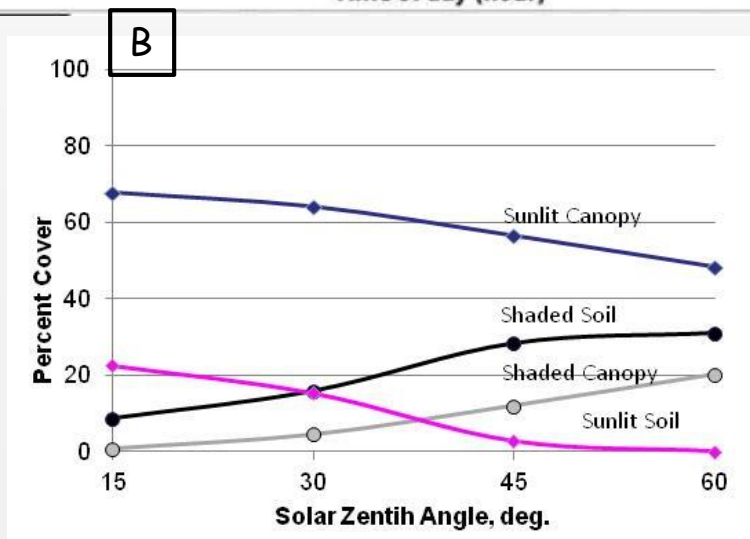
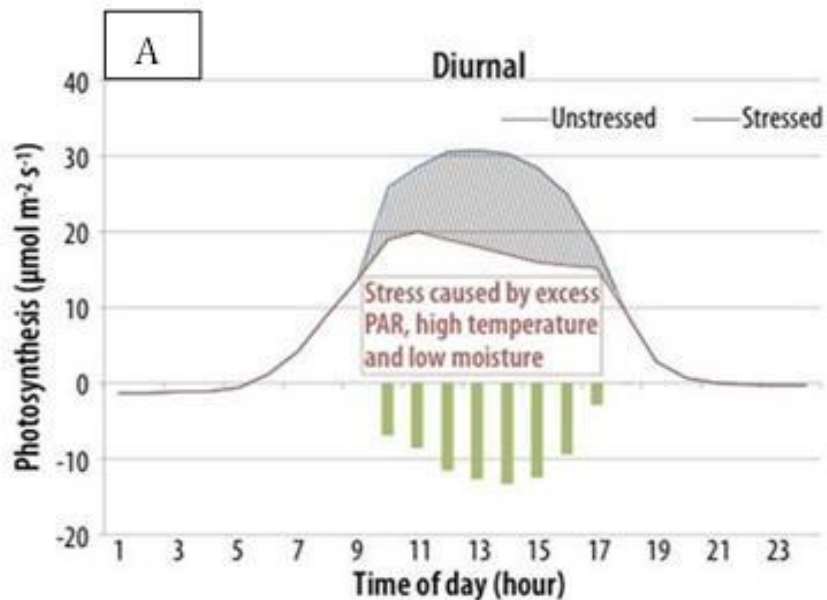

SAFE instruments provide multi-temporal spectral radiance measurements needed for vegetation function, and high definition vegetation structure (for reducing confounding diurnal effects, i.e. scene shadows). A. Diurnal photosynthetic CO_2 uptake for stressed and unstressed conditions. B. Illuminated and shaded vegetation for a forest canopy for changing solar zenith angle.

Spectrometer Freeform Optics



Comparison of Offner Spectrometer Optical Designs when using Freeform Mirrors

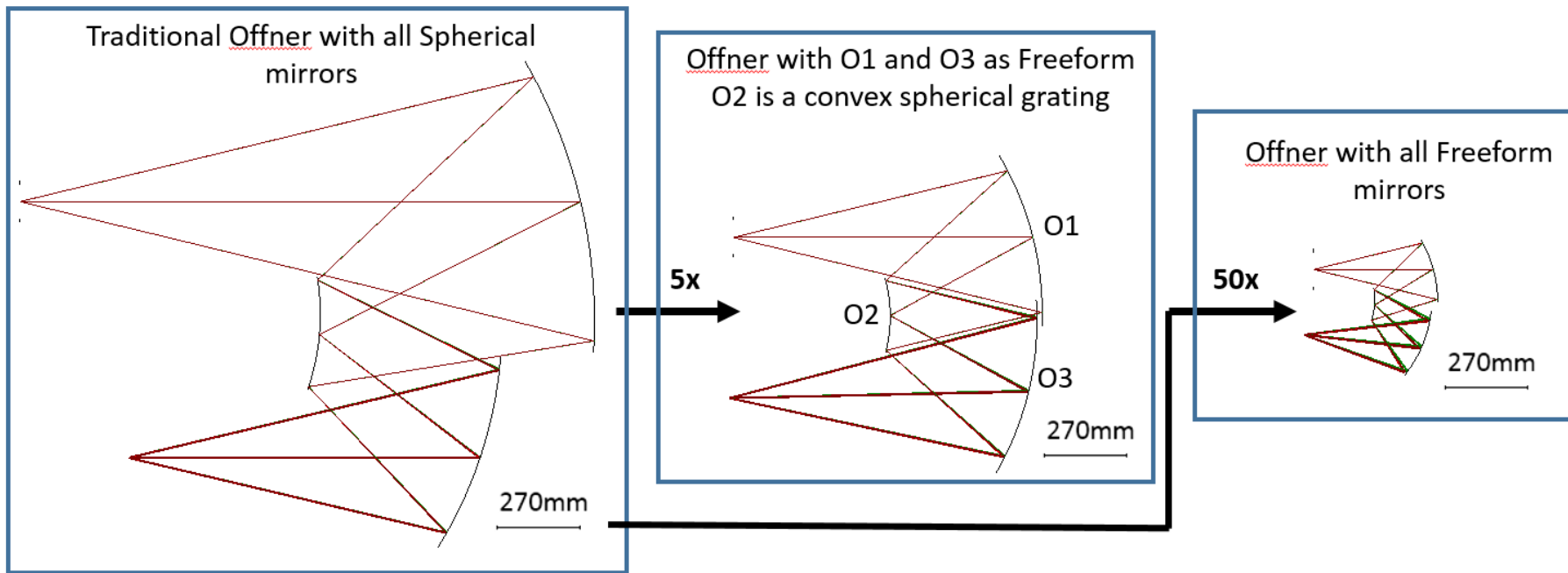

The common Offner spectrometer design form can be reduced in volume by a factor of 5x when using 2 freeform mirrors, and a factor of 50x when using all freeform mirrors with this Field of View. The middle design solution uses a spherical grating mirror (O2), which has a higher TRL but limited volume improvement. Each of these 3 designs has the same 112mm slit width and spectral dispersion requirement. The freeform surfaces can be optimized to correct for the steep ray angles over the wide field of view. This enables a design solution with a much smaller volume and better aberration correction.

SAFE MiniSpec Instrument

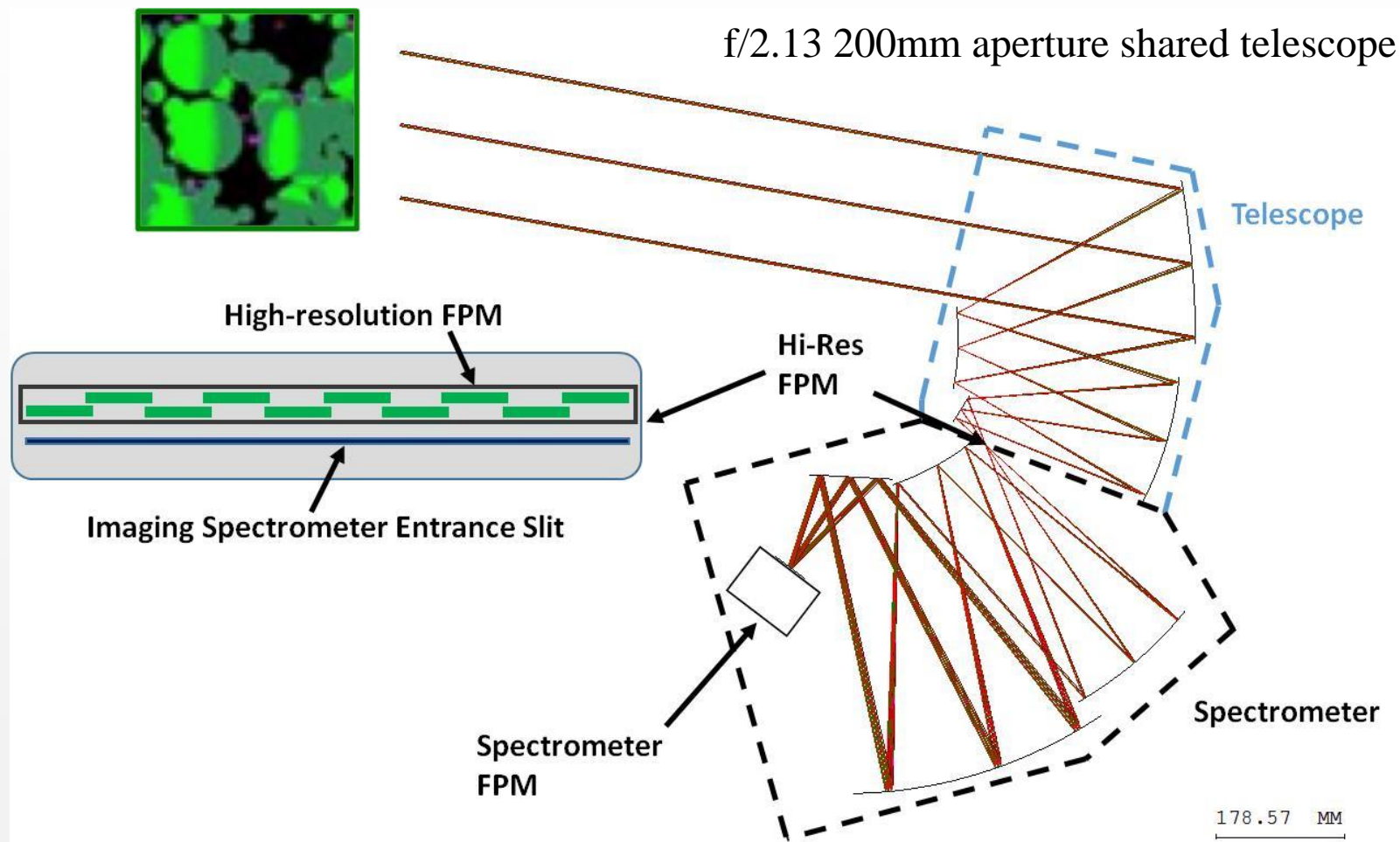



- ◆ Freeform optics are used to **correct aberration** from a fast $<f/2.5$ telescope with a wide field of view.
- ◆ Freeforms are also used to greatly **reduce the volume** of the Offner spectrometer which is driven by the **wide field of view**

NASA Need: low cost, visible quality freeform mirrors



1. Motivation

2. Applications

A. Astrophysics 2020 Decal Survey

- LUVOIR mission
- OST mission

B. Earth Science: SAFE mission

C. Planetary Science: TIMERS instrument

D. CubeSats: XY Penta testbed

Thermal IMager for Europa Reconnaissance and Science

- ◆ Multichannel thermal infrared radiometer with the ability to measure cold surface temperature and reveal composition on Jupiter's moon Europa
- ◆ Two fields of view
- ◆ Wavelengths spectral range 8.5-200 μ m
- ◆ Push Broom operation

Europa Imaged by NASA's Galileo

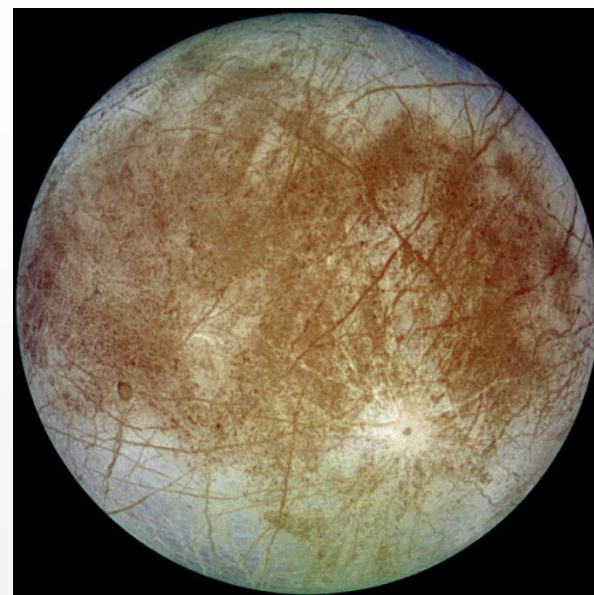

Assess the distribution of surface hazards, the load-bearing capacity of the surface, the structure of the subsurface, and the regolith thickness.

- Determine the distribution of boulders on the Surface
- Characterize the regolith depth

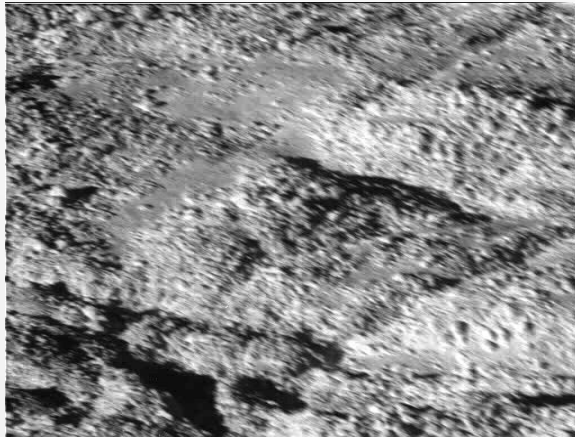

Assess the potential for geologic activity, the proximity of near surface water, and the potential for active upwelling of ocean material in landing zones.

- Thermal mapping instrument is best way to link activity to the surface source regions

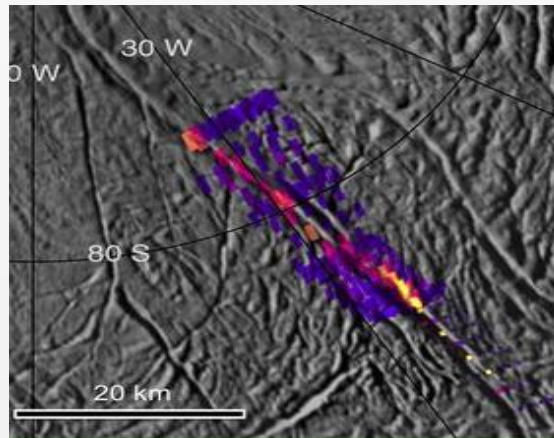

Characterize the ice shell and any subsurface water

- Subsurface water lenses within a few km of the surface should be detectable as a thermal anomaly for up to 100,000 years (Abramov et al., 2013)

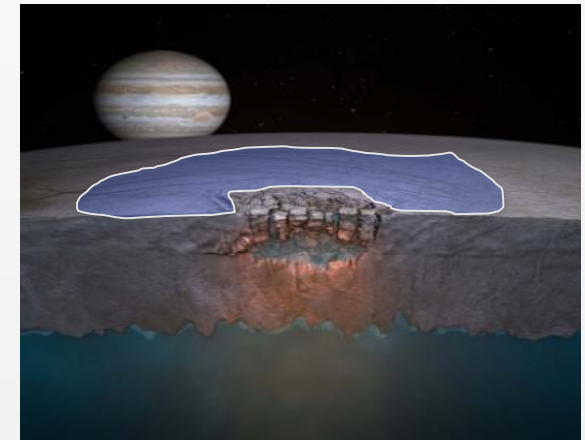

- ◆ Instrument has multiple fields of view with a common detector
 - Wide field for broad surface mapping
 - Narrow field for high resolution imaging
 - Calibration black body
 - Calibration deep space
- ◆ 300mm and 50mm Entrance Apertures
- ◆ <200m Ground Resolution at 100km altitude

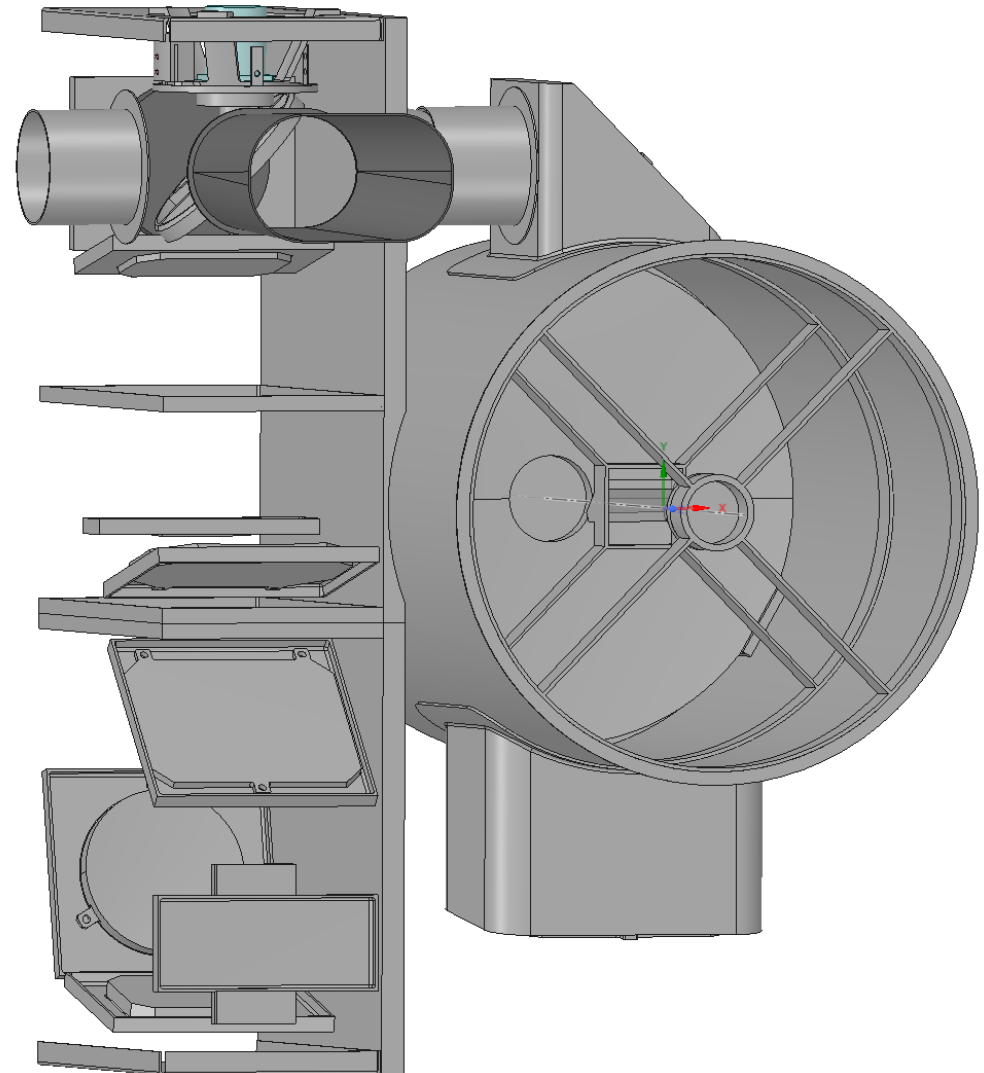

- ◆ Freeform mirrors enable **compact packaging** configuration allowing multiple fields of view to be combine into one instrument
- ◆ Freeform mirrors are also used to **correct aberrations** over the **wide field of view**

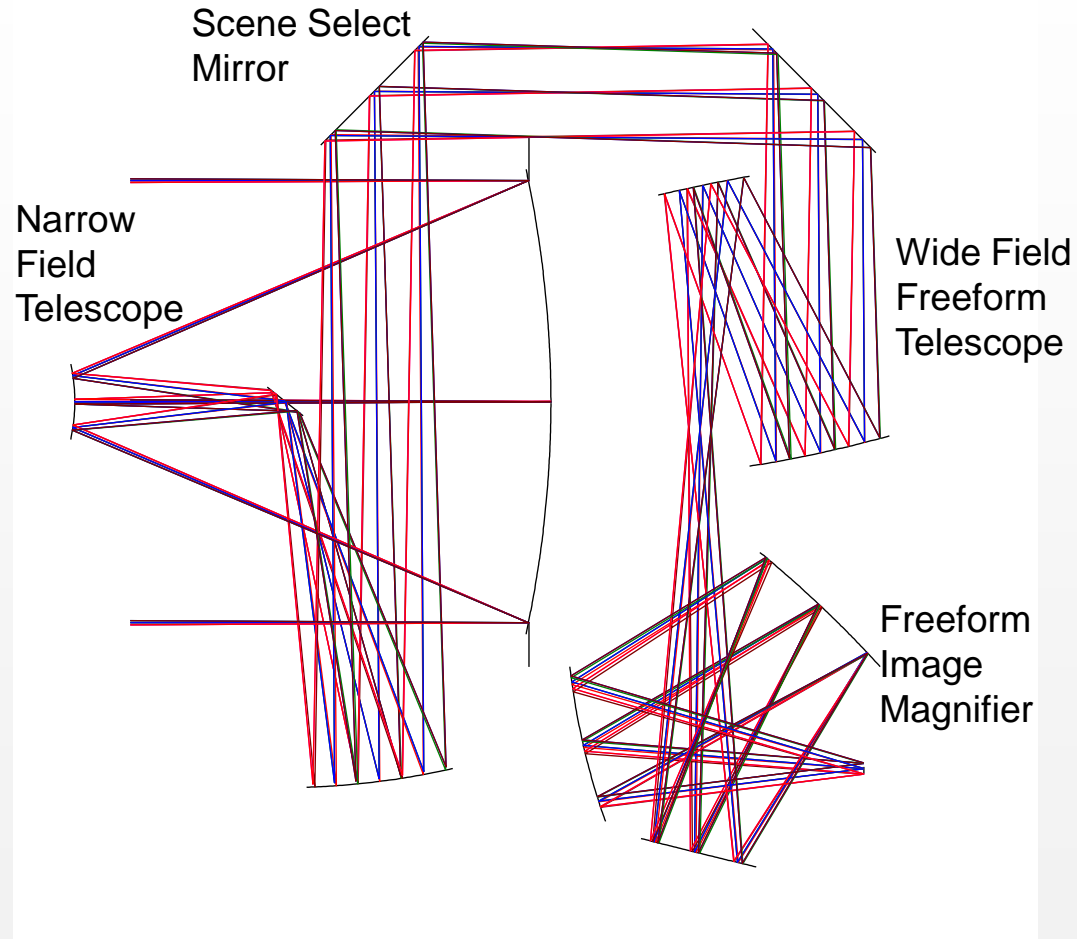

NASA Needs: low cost freeform mirrors with large departure (>1mm) from best fit sphere



1. Motivation

2. Applications

A. Astrophysics 2020 Decal Survey

- LUVOIR mission
- OST mission

B. Earth Science: SAFE mission

C. Planetary Science: TIMERS instrument

D. CubeSats: XY Penta testbed

2 Mirror Freeform Design Survey



- ◆ Compare the different designs forms using 2 freeform mirrors
 - Form #1: Z-configuration (Positive-Positive tilts)
 - Form #2: 4-configuration (Positive-Negative tilts)
- ◆ XY Polynomials
- ◆ Telecentric vs. Non-telecentric designs
- ◆ Evaluate how wide of a field and fast of an F/#
- ◆ Image quality of $<20\mu\text{m}$ RMS Spot diameter

Freeform Design Forms

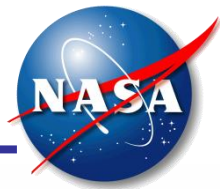

Z Configuration

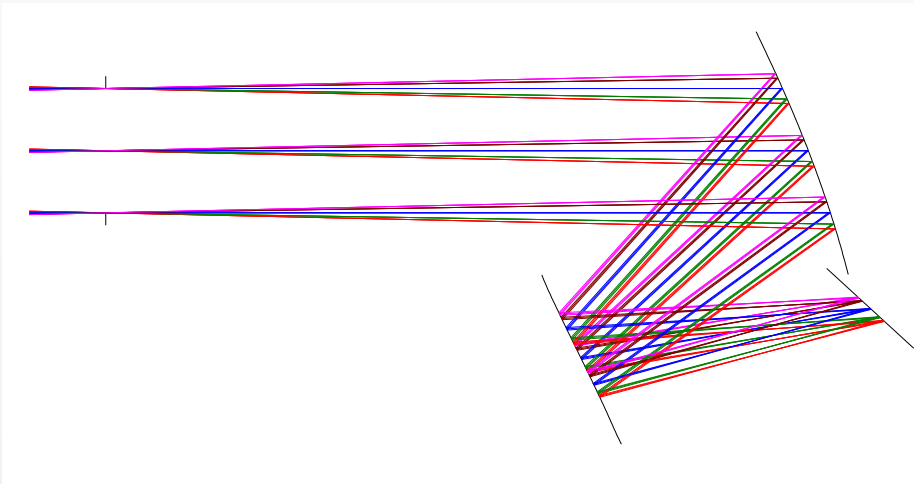

4 Configuration

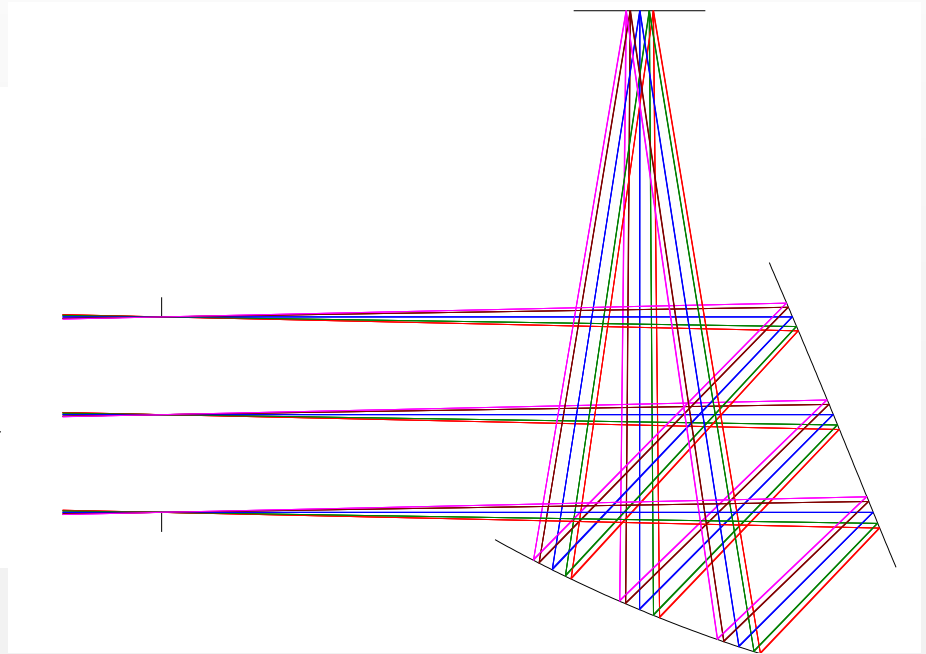

Design Survey FOV x F/#



2 Mirror Design Space | FOV Aspect Ratio of 4:1

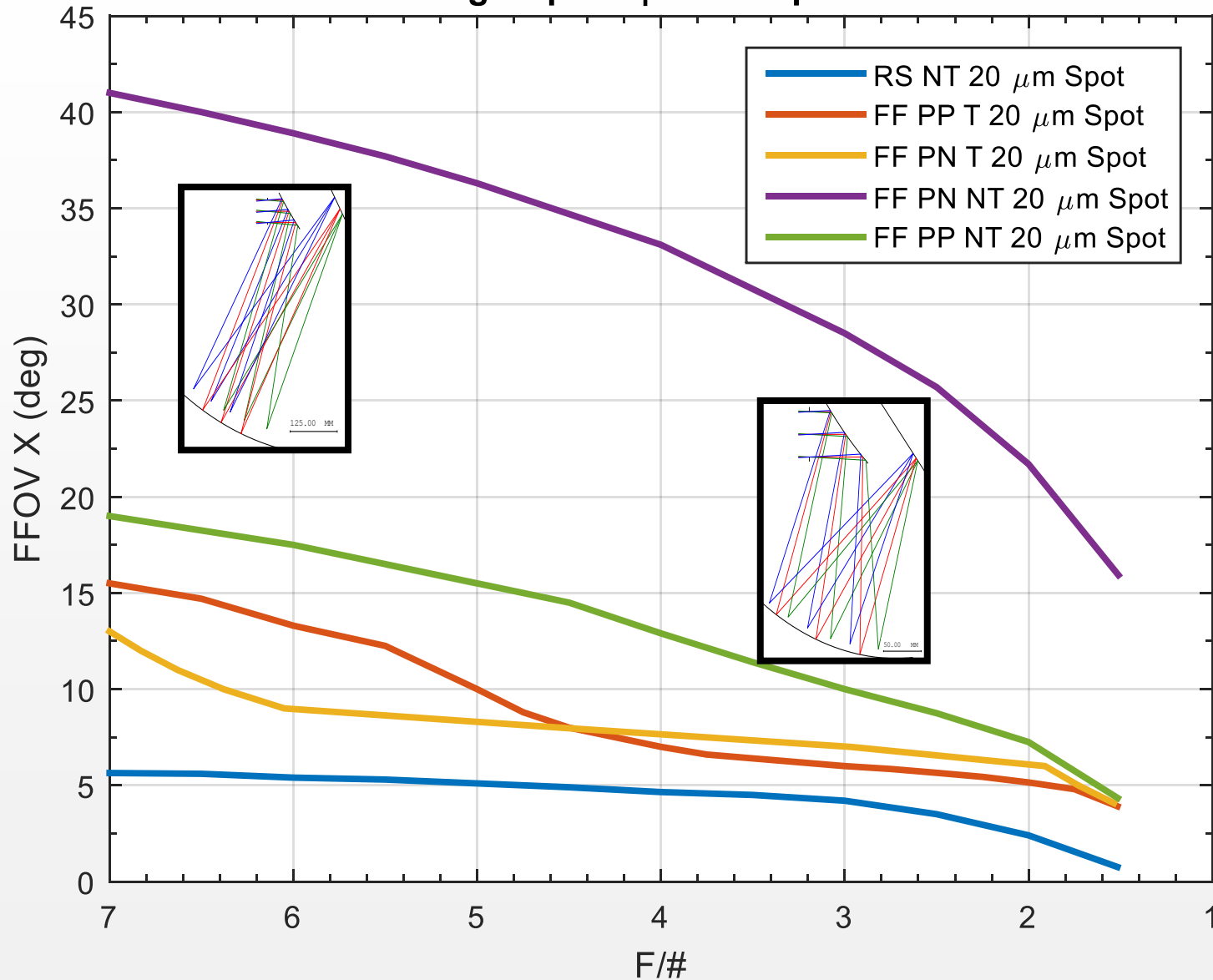

Design Survey Volume x F/#

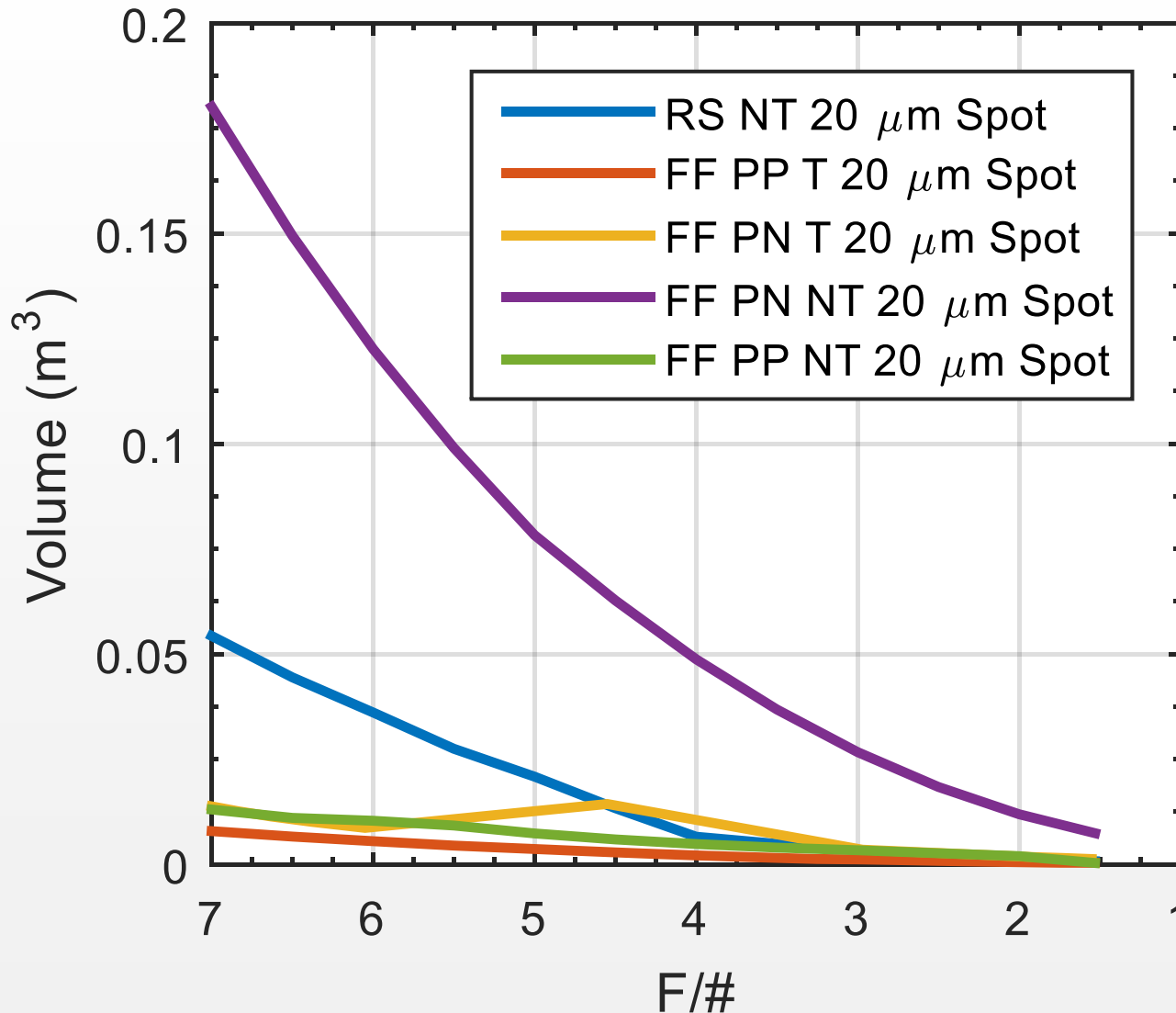

XY Penta Specifications



- ◆ Using design survey results the PP NT design best balances image quality and minimum volume
- ◆ Cube Sat application
- ◆ f/5 50mm EPD
- ◆ 8.73deg x 2.86deg
- ◆ 90deg beam deviation

XY Penta 2 Mirror Telescope

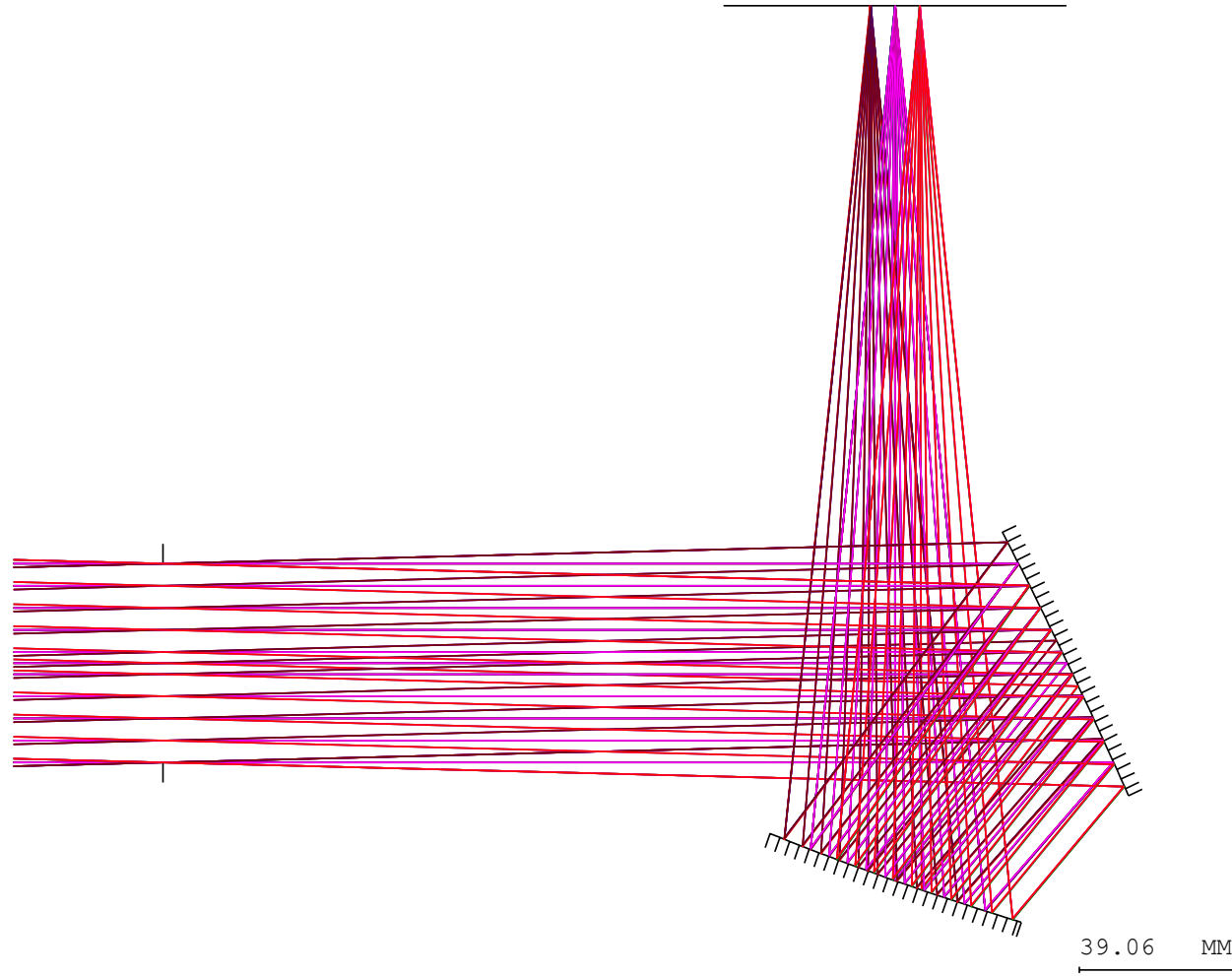

Plane-Sym 2-mirror telescope

Scale: 0.64 GJW 11-Oct-17

XY Penta Hardware

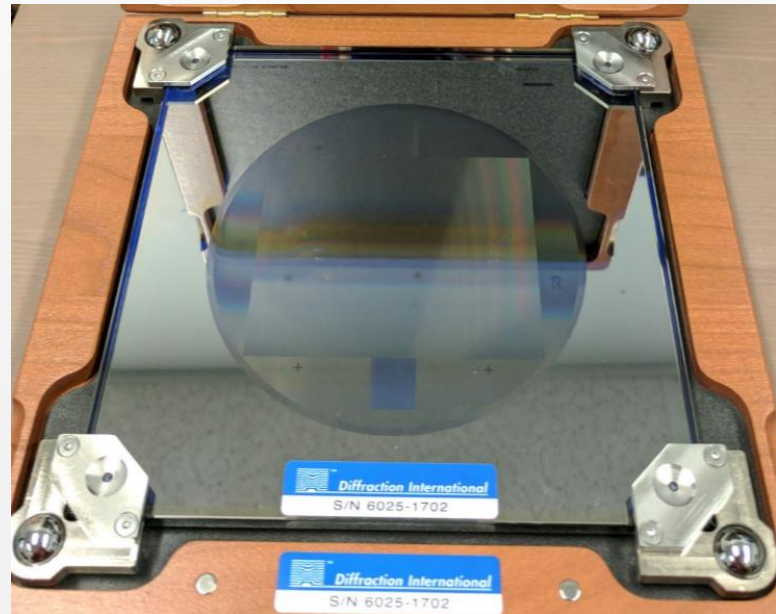
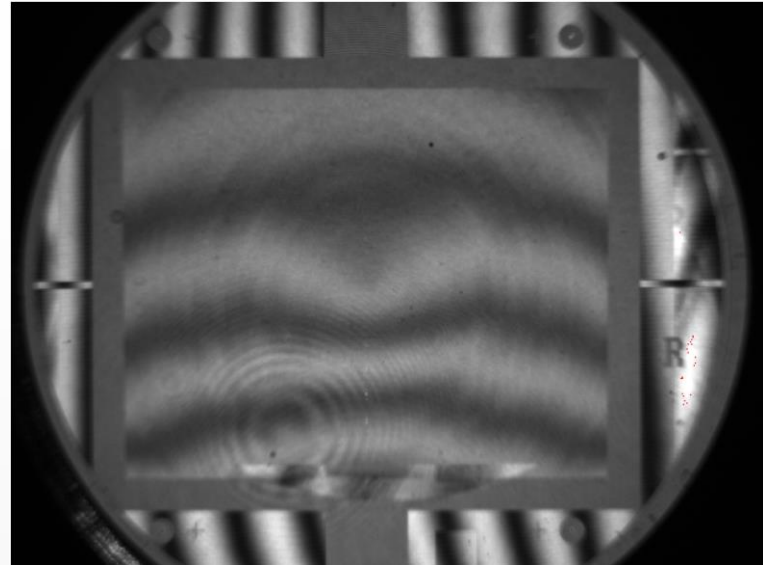

Concluding Remarks



- ◆ **Freeform optics** enable future NASA missions
 - Large astrophysics missions such as LUVOIR and OST
 - Small, wide field Earth Science and Planetary missions such as MiniSpec, TIMERS, or CubeSats

- ◆ NASA is working with industry to improve freeform fabrication quality, testing and cost
 - NASA SBIR program
 - NASA Space Technology Mission Directorate Programs

Thank You!



- ◆ EPIC for inviting me to talk today
- ◆ Matt Bolcar –LUVOIR
- ◆ Dave Leisawitz –OST
- ◆ Jon Ranson –MiniSpec
- ◆ Ish Shahid-TIMERS
- ◆ NASA Freeform optics Research Group Endeavor

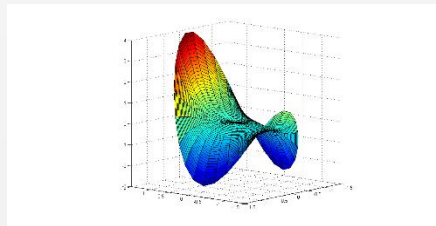

Backup



TIMERS Instrument Overview

Parameter	Property	
Instrument Type	Infrared Radiometer	
Target Temperature	50 to 300 K	
Temperature Accuracy	≤2 K	
Spectral Range	8-to-200 μm in five distinct spectral channels	
Detector Type	Thermopile	
Detector Format	(5x64) pixel array	
Pixel Size	250 μm x 250 μm	
F-number	f/#2 at image plane	
Etendue ($A\Omega$)	1.23 x 10 ⁻⁹ m ² sr	
Telescope	Narrow Field	Wide Field
Aperture Size	300 mm	50 mm
Detector Pixel iFOV	0.42 mrad	2.5 mrad
Resolution @ 60,000 km	25 km	150 km
Resolution @ 600 km	250 m	1.5 km
Resolution @ 100 km	84 m (2-pixel bin)	250 m
Mass	~9.4 kg (without harness)	
Envelope	780 mm x 586 mm x 579 mm	
Science Power	~8.7 W	
Mission Data Volume	~7.6 Gbits (Using as an example the 45 flyby's of the Europa Mission 13-F7 trajectory)	
Operating Modes	Multiple modes with minimum 0.1 s and maximum 1 s signal integration period	
Observation Strategy	Nadir pushbroom mapping	

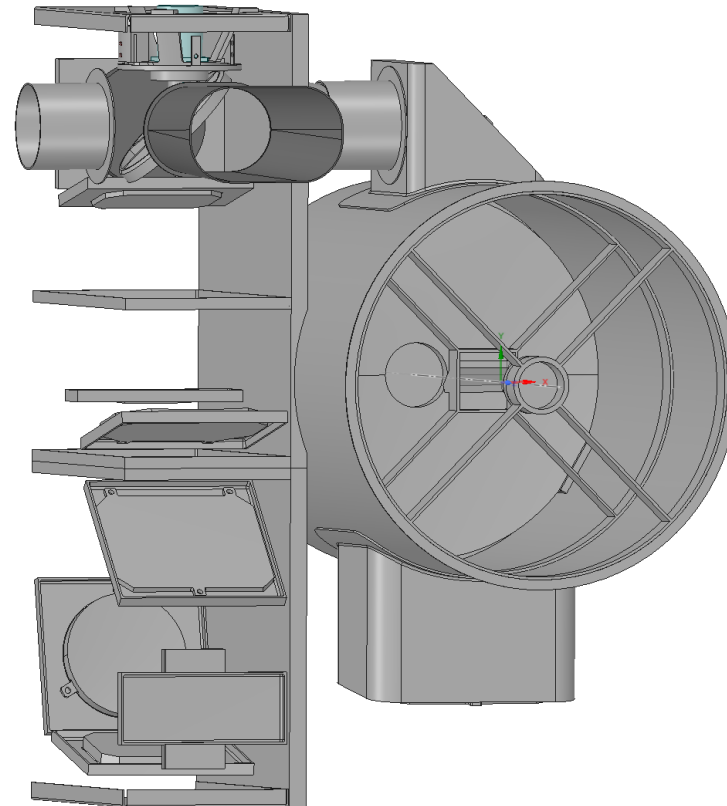



Rationale

- NASA has a strong interest in detecting and predicting changes to Earth's ecosystems as described in our Strategic and Science plans
- Earth's vegetated ecosystems sustain life on Earth
 - They *provide food, fiber and habitat and operate as key components of the carbon, water and energy cycles.*
 - *Remove CO₂ from the atmosphere and convert it to stored biomass (and oxygen)*
 - *Are susceptible to weather extremes and changing climate.*
- Vegetation functions in response to its environment that varies through the day.
- Vegetation productivity is also related to 3D structure, as it is a key factor in determining the light environment within the canopy.
 - Productivity can be estimated by light use efficiency (LUE) models with remote sensing inputs that account for vegetation stress from soil moisture, disease and insects.
- Shadows caused by 3-D structure and solar angle limit the accuracy of this approach from space.
- Accurate GPP and LUE measurements require multitemporal measurements.

Global Snapshot of Net Primary

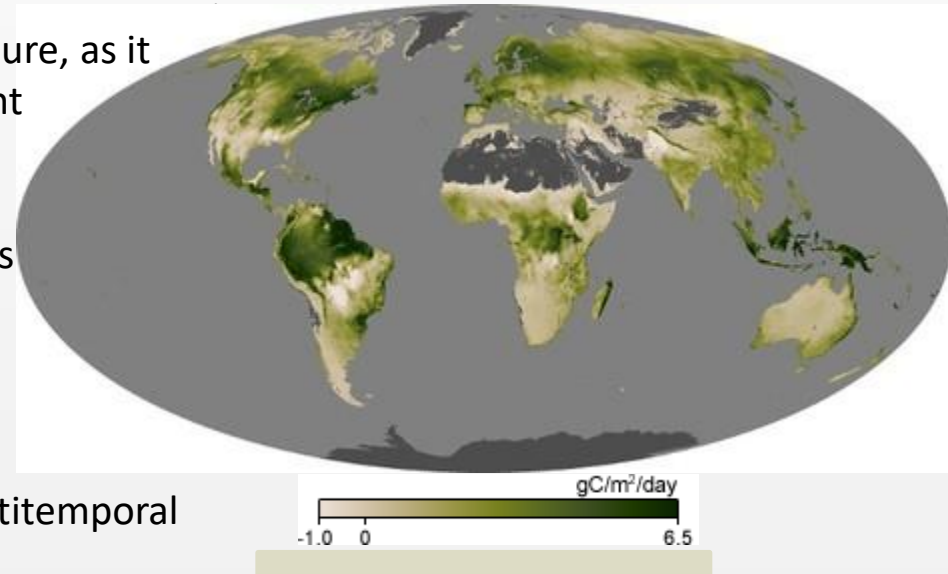



Background

- The major information domains in remotely sensed data are: spectral, spatial, and temporal.
- The temporal domain is an area that is under-explored in land surface remote sensing.
- Vegetation responds to changing environmental conditions in different ways at different timescales:
 - Regulation => xanthophyll cycle pigments => minutes to hours
 - Adaptation => photoprotection, changes in carotenoid pigment pools => multiple days
 - Structure => photodamage, senescence => Monthly/seasonal to yearly
 - Succession => species change => decades
- The response rates and magnitudes vary among vegetation types and seasonal stage, and with the nature and magnitude of environmental stresses.
- The magnitude, rate, and duration of these responses determine ecosystem processes such as carbon balance and evapotranspiration.
- Existing approaches, such as NDVI from AVHRR and MODIS, and proposed missions like Hypersi are useful for addressing the changes at weekly/monthly time scales-but we know little about the nature and importance of the far more frequent short-term responses (Regulation and Adaptation)
- Multi-temporal measurements of structure and functioning of vegetation will provide the complete and more accurate measurements of productivity to advance NASA Carbon Cycle and Ecosystems science

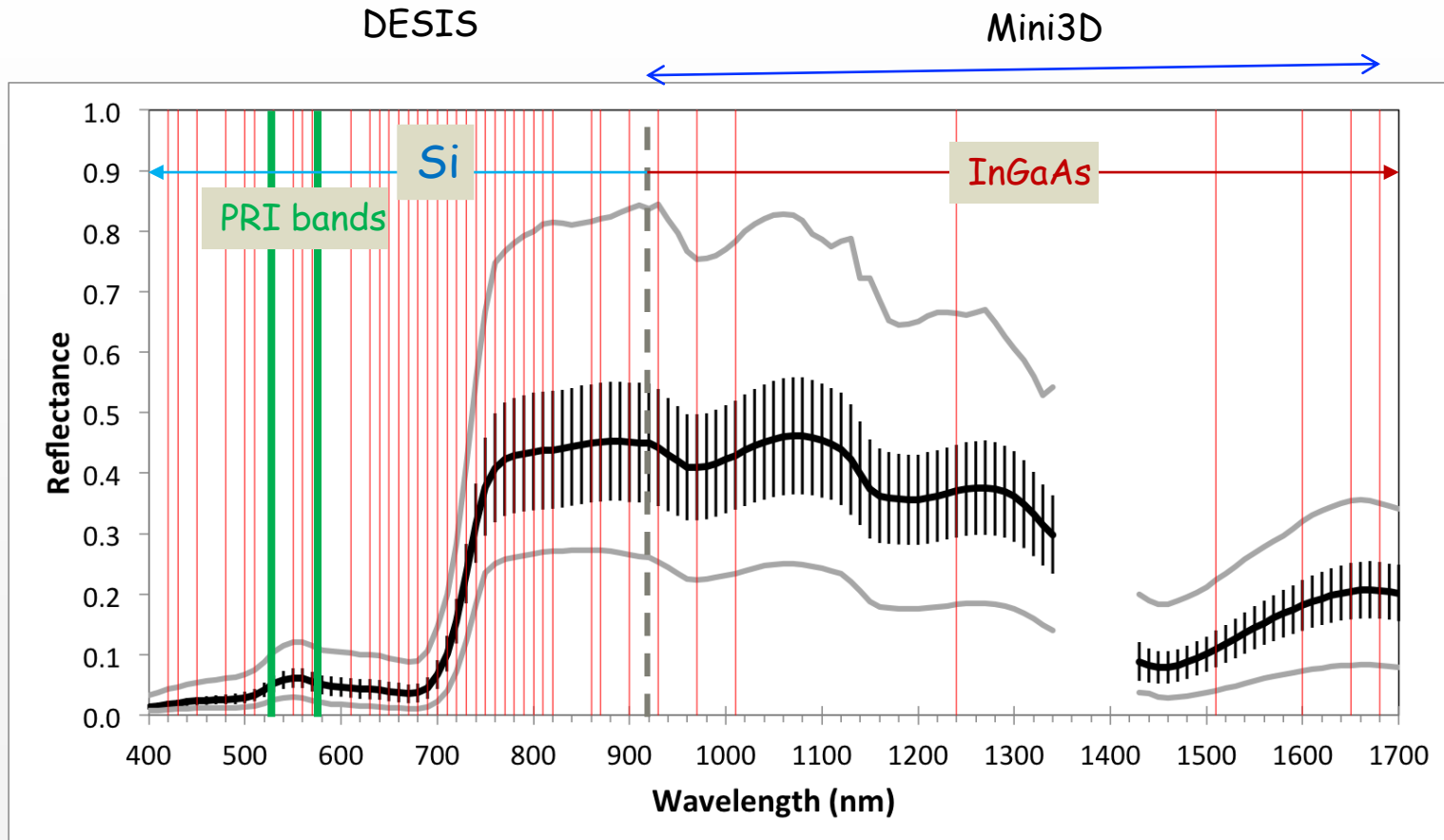

Spectral bands used by Vegetation Indices are indicated by vertical red lines. Green lines show PRI bands, (band locations rounded to nearest 10 nm)

Spectral reflectance mean and standard deviations are from corn field data covering diurnal periods over two growing seasons. Gray lines indicate minimum and maximum reflectances(F. Huemmrich/UMBC, E. Middleton/GSFC) .

Science Concept

Combined measurements of structure and functioning of vegetation will provide complete and more accurate measurements of productivity to advance NASA Carbon Cycle and Ecosystem focus area science.

- Objective is to acquire temporal fine spectral resolution reflectance for plant functional indices and high-spatial resolution for vegetation 3D structure.

- MiniSPec -Miniaturized spectrometer to measure photo chemical reflectance indices and other vegetation functional variables*

- Mini3D –High resolution stereo imager for 3D structure including % shaded and sunlit vegetation*

- Data acquisition up to 3 measurements in a day over the growing season for key biomes.

