

Additive Construction with Mobile Emplacement (ACME)

3D Printing Structures with In-Situ Resources

Mike Fiske, Jennifer
Edmunson, and the
ACME Team

November 7, 2017



ACME Overview

ACME

- Partnership between NASA (MSFC, KSC), USACE, and Contour Crafting Corporation (NR-SAA with Caterpillar)
- Based on a collaboration between NASA/MSFC and USC/CCC (Dr. Behrokh Khoshnevis) beginning in 2004.
- Funded by NASA/STMD-GCDP and USACE-ERDC
- Additional contributions from the University of Mississippi, University of Arkansas in Little Rock, East Carolina University, and the Pacific International Space Center for Exploration Systems (PISCES)



ACME-1 System

Contour Crafting



- An Additive Construction technology not limited to concrete or water-based binders
 - The contour crafting process has been used to build structures of
 - Gypsum
 - Portland cement-based concrete
 - Sulfur concrete
 - Ceramics
 - Future binder development includes Sorel-type cements and polymers
 - Polymer-based construction material research already carried out at MSFC by Dr.'s Sen and Edmunson
 - Lunar sulfur concrete work by Dr.'s Grugel and Toutanji at MSFC/UAH
 - Dr. Khoshnevis/CCC has a NIAC to work on sulfur-based concrete for full-scale structures

Why Additive Construction?

- US Army Corps of Engineers (USACE) needs a technology that will help:
 - Provide structures on-demand in a variety of settings
 - Build a structure in 1 day (takes 5 days now)
 - Reduce construction personnel from 8 to 3 per structure
 - Reduce the amount of material brought into the field from 5 tons to less than 2.5 tons
 - Improved security during construction
 - Reduce construction waste from 1 ton to less than 500 pounds
 - Build the structure to look like local housing using digital models; avoid becoming a target
 - Adaptable design, multiple geometries
- State of Hawaii is interested (and is partially funding PISCES) to identify construction materials and techniques that do not require materials imported from the mainland. KSC is working closely with PISCES on this effort.

Why Build ACME?

- NASA needs the technology to:
 - Utilize in-situ resources to provide habitats, garages, berms, landing pads, radiation shielding, etc. (Deep Space Mission Infrastructure)
 - Minimize the amount of material launched from Earth (estimated savings between 60% and 90%)
 - Applies to Decadal Survey area AP10, Technology Roadmap areas TA04, TA07, TA12
 - Project matures related technologies
 - Regolith excavation and handling
 - Contour crafting
 - Optimized planetary structure design

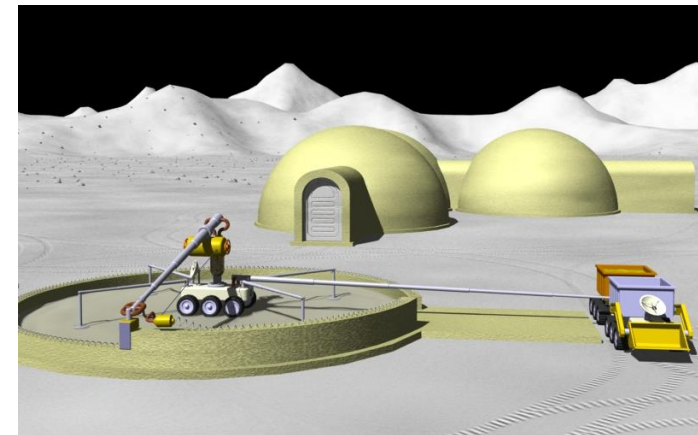

ACME and ACES System Design

ACME-1 System

USC as-delivered “2-D” system in 2004 that translated in X & Z directions and head rotated, allowing for long, slender wall fabrication.

Undertook effort in 2005 to add a 3rd dimension of travel to allow fabrication of different geometries. Also began experimenting with different nozzle configurations.



Also undertook a significant effort to match concrete composition using COTS products that are different in Alabama from those in California (Portland cement, stucco, additives).

ACME-1 System

Completed conversion to “3-D” system, resolved composition issues, and began programming and printing various simple geometries.

Experimented with translation rate vs concrete cure time and strength to optimize overall process.

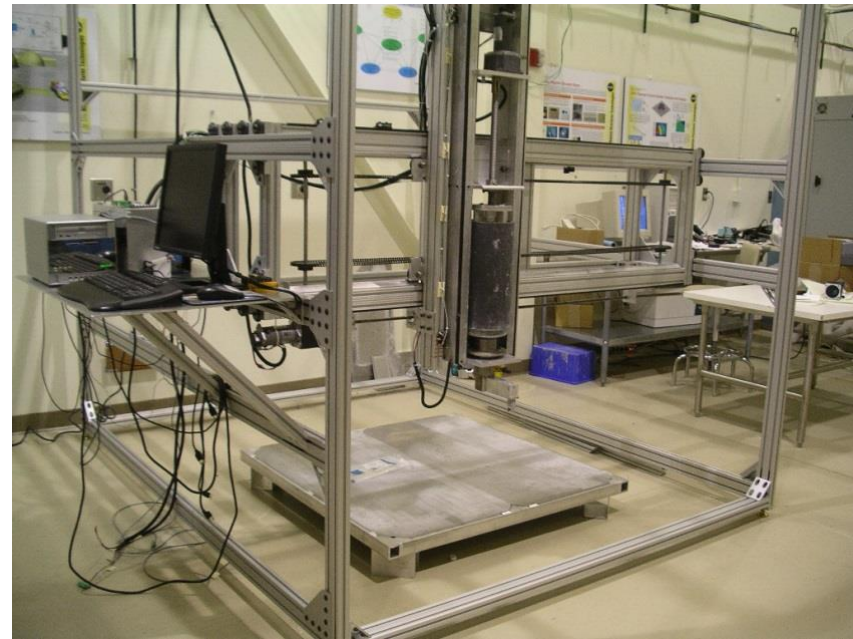
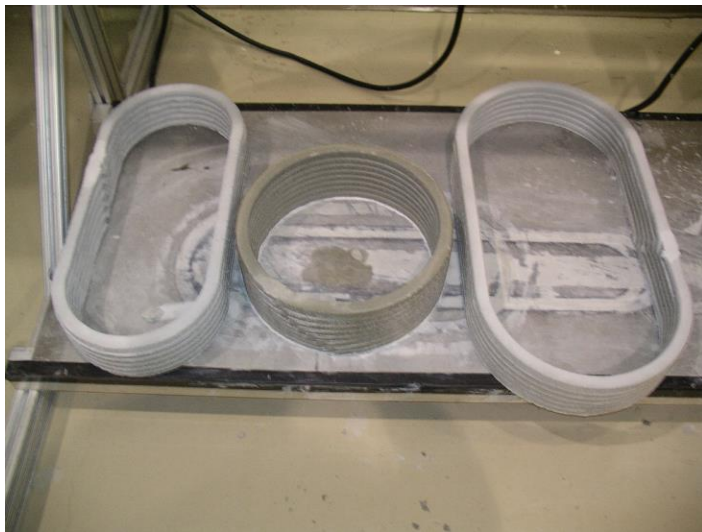

ACME-1 System Dome Development



Evolution from ACME-1 to ACME-2

Focus was on converting from a “batch” system to a “continuous feed” system.

- Enables larger structures
- Eliminates poor layer-to-layer bonding from batch to batch
- Eliminated discontinuities between batches

Removed extrusion chamber and plunger hardware, replaced with large mixer, continuous pump, accumulator, hoses, fittings, etc.

Incorporated use of slump measurements and viscosity measurements (Germann Instruments) to characterize concrete properties/pump performance.



ACME-2 System

Gantry Mobility System (good x, y, z positioning)

Mixer

Pump

Accumulator (allows pump to stay on when nozzle closes for doors/windows)

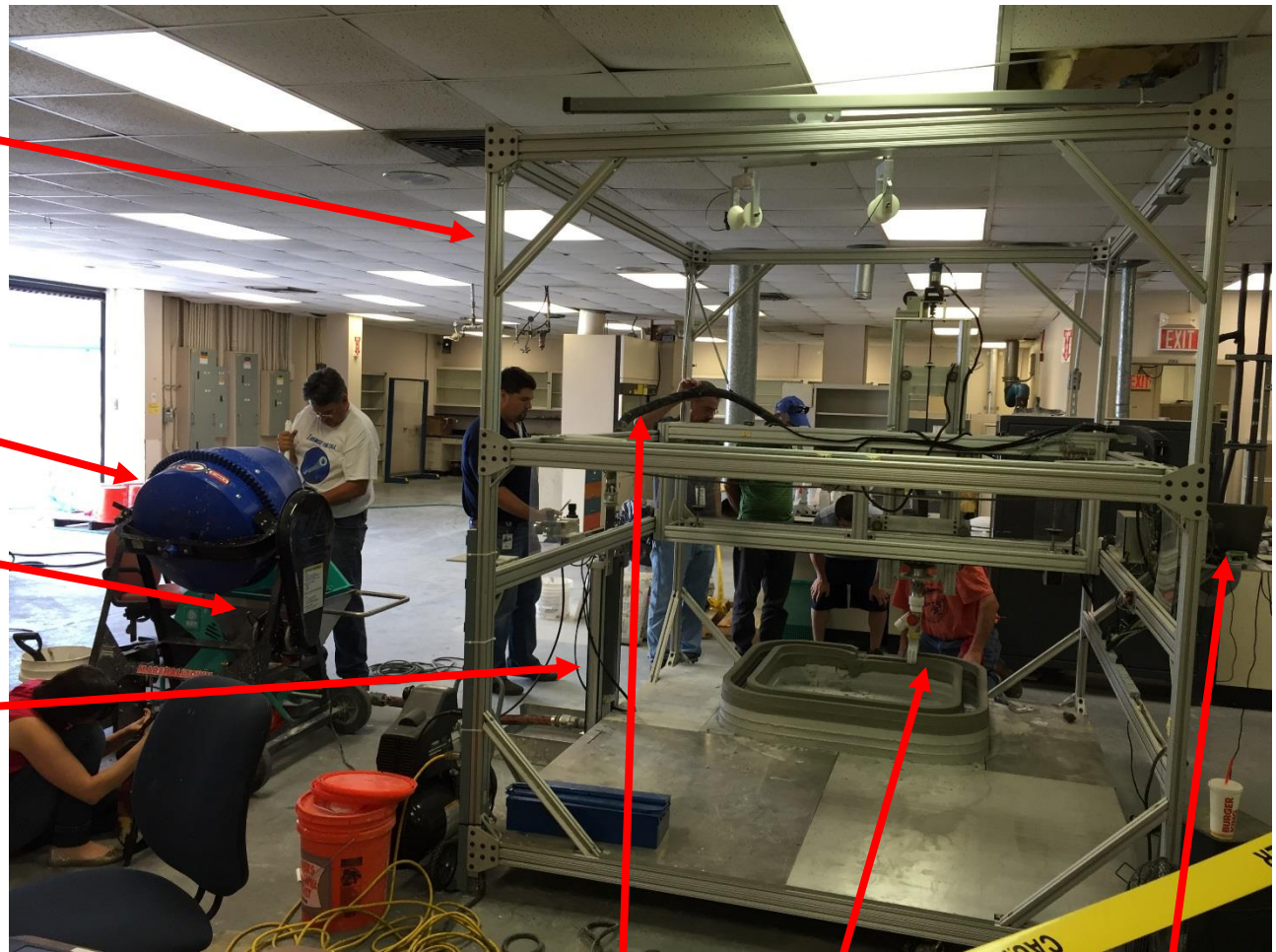

Hose

Nozzle

Control System

Evolution from ACME-2 to ACES-3

Focus was on transition from sub-scale to full-scale.

Issues included:

- Optimum mobility system (gantry vs truck/boom arm vs robotic arm, etc)
- Hose management
- Cleaning
- Positional accuracy
- Mobility
- Assembly/disassembly considerations
- Print speed/volumetric flow rate considerations



Key ACES-3 Requirements

- Relocate entire system in no more than three 8' x 8' x 20' volumes (Army Conex box or PLS) – 10,000 lbs/PLS
- Complete set-up and alignment in 11 hours
- Print in X and Y axis at up to 500 in/min with a volumetric flow rate of up to 800 in³/min
- Nozzle positional accuracy of +/- 1/8" in all three axes during printing
- Operate entire system with no more than 6 personnel (goal of 3)
- Concrete composition to include up to 3/8" aggregate
- Automated dry goods (7) and liquid goods (5) feed system

ACES-3 System

Dry Good Storage Subsystem

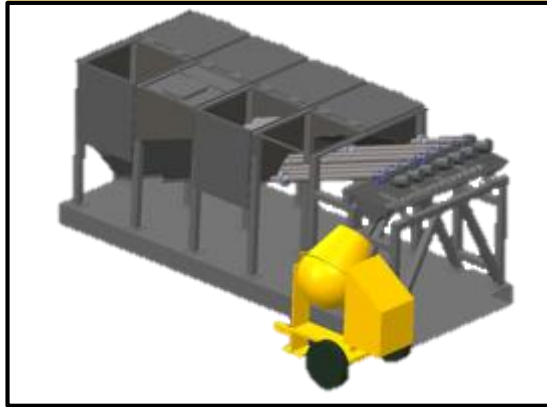

Liquid Storage Subsystem

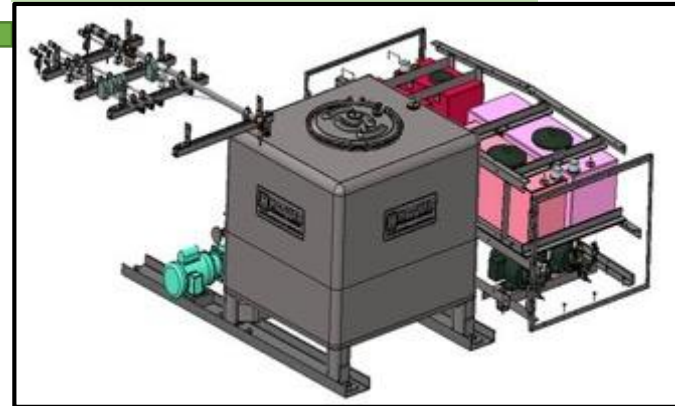

Continuous Feedstock Mixing Delivery Subsystem (CFDMS)

- Accumulator
- Pump Trolley
- Gantry
- Hose Management
- Nozzle
- Electrical & Software

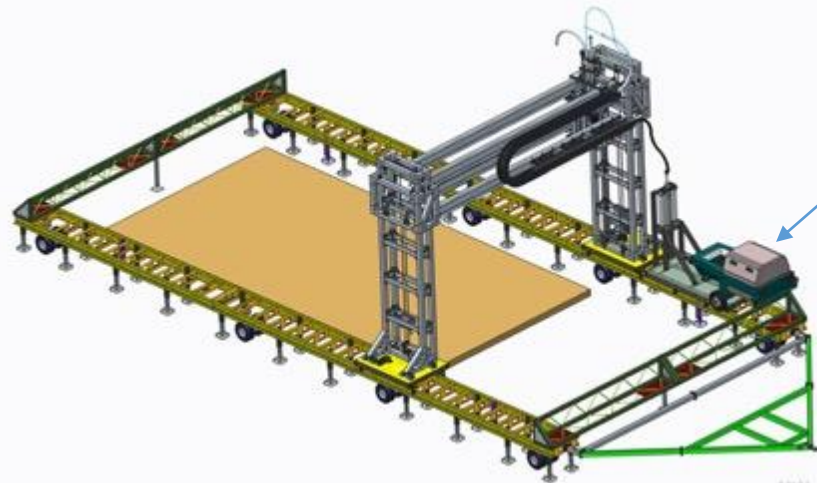

Dry Goods &
Liquid Goods
parked on side

ACES-3 System



ACES-3 System



ACES-3 System



ACES-3 System



ACES-3 System







ACES-3 System



ACME Planetary Materials

System Affects on Materials

Mixer	Pump	Hoses and Accumulator	Gantry	Nozzle
				
<ul style="list-style-type: none">• Can inadequately mix• Amount (batch size)• Time to mix properly	<ul style="list-style-type: none">• Can add air• Can redistribute air bubbles• Pressurizes the concrete• Clogs (needs more vibration)• Continuity of flow	<ul style="list-style-type: none">• Can affect air distribution• Settling• Continuity of flow• Material (friction)	<ul style="list-style-type: none">• Dictates hose position (vertical and horizontal drops, kinks in hose)• Size of printed structure	<ul style="list-style-type: none">• Can stop flow• Trowel needs to be easy to use• Size of nozzle will dictate flowability and extrusion• Material of the nozzle (friction/ abrasion)

ACME-1 Materials

- Standard mix contains Portland cement, stucco mix, water, and a rheology control admixture
- Martian simulatant mix contains standard mix with JSC Mars-1A simulatant
- Printed at terrestrial ambient conditions



ACME Materials

- The original composition of the mix dictates:
 - Viscosity
 - Extrudability / workability
 - Initial set time
 - Initial strength to support superimposed layers
 - Temperature range acceptable for setting
 - Pressure range in which it can be printed
 - Functional temperature range for the cured material
 - Resistance to material aging in a planetary surface environment
 - How much material will need to be brought from Earth

Planetary Constraints

- Environment of deposition is the greatest constraint in the materials we choose for additive construction

Parameter	Mars	Moon
Gravity	1/3 that of Earth	1/6 that of Earth
Pressure at surface	3-10 Torr (4×10^{-3} to 1×10^{-2} ATM)	2×10^{-12} Torr (3×10^{-15} ATM)
Surface Temperatures	-89 to -31 Celsius (Viking 1)	-178 to 117 Celsius (equator)
Radiation (solar wind particles, galactic cosmic rays)	Some protection offered by atmosphere	Some protection offered by Earth's magnetic field
Surface reactivity	Perchlorates (highly oxidizing)	Reduced material (nanophase iron, elemental sulfur)

Material Requirements

- For emplacement (extrusion) of additive construction material in a pressurized or ambient environment
 - Must flow and de-gas well
 - Must not set up (harden/cure) within the system
 - Must not shrink significantly while setting
 - Must allow for superimposed layer adhesion and support
- For accommodating internal pressurization
 - Must have significant tensile strength or the design of the structure must place the material in compression (e.g., inverted aluminum can and/or regolith cover)

Material Requirements

- For radiation and micrometeorite protection / shielding
 - Must have sufficient regolith cover and/or be composed of known shielding materials
- For long-duration use (resistance to aging)
 - Must withstand extreme temperature swings of the exterior environment while withstanding heating/cooling of the interior
 - Must withstand or self-heal damage due to radiation or micrometeorites by design or material
 - Must not become brittle over time
 - Must not be flammable, decompose, or become toxic when exposed to water, oxygen, or carbon dioxide (unless a liner/skin is used)

Material Considerations

- In-situ materials are site-dependent
 - Terrestrial example (PISCES involvement in ACME): Hawaii is interested in creating construction materials from basalt; all Portland cement, asphalt, etc. building material has to be brought in from the continental US.
 - Moon or Mars? Poles or Equatorial Region? Basalt or Sedimentary Rock?
 - Binder selection must reflect and complement available materials
- USACE
 - Variations in globally available concrete
 - Need to regulate / accommodate for moisture in available materials

Available Materials - Mars

Mineral	Other Materials
Major minerals	Present everywhere (“dew”)
Feldspar ($\text{CaAl}_2\text{Si}_2\text{O}_8$ - $(\text{Na},\text{K})\text{AlSi}_3\text{O}_8$)	Perchlorates (ClO_4^-)
Pyroxene ($(\text{Ca},\text{Mg},\text{Fe})\text{Si}_2\text{O}_6$)	Atmosphere
Olivine ($(\text{Mg},\text{Fe})_2\text{SiO}_4$)	CO_2 (95.32%)
Minor minerals	N_2 (2.7%)
Hematite (Fe_2O_3)	Ar (1.6%)
Magnetite (Fe_3O_4)	O_2 (0.13%)
Clays (Fe-Mg silicates, K-Al silicates)	CO (0.08%)
Sulfates (gypsum-Ca; jarosite-K,Fe; epsomite-Mg)	H_2O (210ppm)
Carbonates (calcite-Ca, dolomite-Mg)	NO (100ppm)
Poles – solid CO_2 (both) and H_2O (northern pole)	

Available Materials - Moon

Minerals	Permanently Shadowed Regions
Highlands (Major Minerals)	LCROSS (ejected material)*
Anorthite ($\text{CaAl}_2\text{Si}_2\text{O}_8$)	Regolith (~85%)
Pyroxene ($(\text{Ca},\text{Mg},\text{Fe})\text{Si}_2\text{O}_6$)	CO (5.70%)
Olivine ($(\text{Mg},\text{Fe})_2\text{SiO}_4$)	H ₂ O (5.50%)
Mare (Major Minerals)	H ₂ (1.39%)
Feldspar ($\text{CaAl}_2\text{Si}_2\text{O}_8$ - $(\text{Na},\text{K})\text{AlSi}_3\text{O}_8$)	H ₂ S (0.92%)
Pyroxene ($(\text{Ca},\text{Mg},\text{Fe})\text{Si}_2\text{O}_6$)	Ca (0.79%)
Olivine ($(\text{Mg},\text{Fe})_2\text{SiO}_4$)	Hg (0.48%)
Minor / Trace Minerals	NH ₃ (0.33%)
Baddeleyite (Zr oxide)	Mg (0.19%)
Apatite (Ca phosphate)	SO ₂ (0.18%)
Zircon (Zr, Si oxide)	C ₂ H ₄ (0.17%)
Spinel (metal oxide)	CO ₂ (0.12%)
Ilmenite (Fe, Ti oxide)	CH ₃ OH (0.09%)
Whitlockite (Ca phosphate)	CH ₄ (0.04%)
Troilite (Fe sulfide)	OH (0.002%)
Other phase of note – nanophase iron	* Larson et al. (2013)

Material Considerations

- The mix should:
 - Minimize water consumption
 - Be adjustable for slightly different compositions of regolith; not require a very precise mix
 - Be easy to emplace (including layer adhesion)
- The binder should:
 - Require a minimal amount of processing and energy to produce from in-situ resources
- The regolith used should:
 - Require a minimal amount of power to mine (i.e., use loose regolith when possible)

Some Previous Materials Work

- Sulfur used as a binder
 - Studied at MSFC in 2004-2007 timeframe with lunar simulant (R. Grugel, H. Toutanji)
 - NIAC to Dr. B. Khoshnevis
 - Scaling up contour crafting for full-scale sulfur printing
 - Currently studied by Northwestern University (among others)
- Gypsum
- Polymers (e.g., Sen et al. 2010)
- Sintering
 - Laser, microwave, oven
 - Useful for Hawaiian material
- Basalt rebar/fibers



ACME Materials

- Binders currently under study
 - Ordinary Portland Cement
 - Magnesium oxide-based cements
 - Sodium silicate (ACME and CIF)
 - Geopolymers
 - Polymers (KSC, Centennial Challenge Teams)
- Additives
 - Carbon nanotubes
 - Fibers
 - Polymers
- Simulants JSC Mars-1A (martian) and JSC-1A (lunar)

Compression Test Samples

Sample prep in 4739

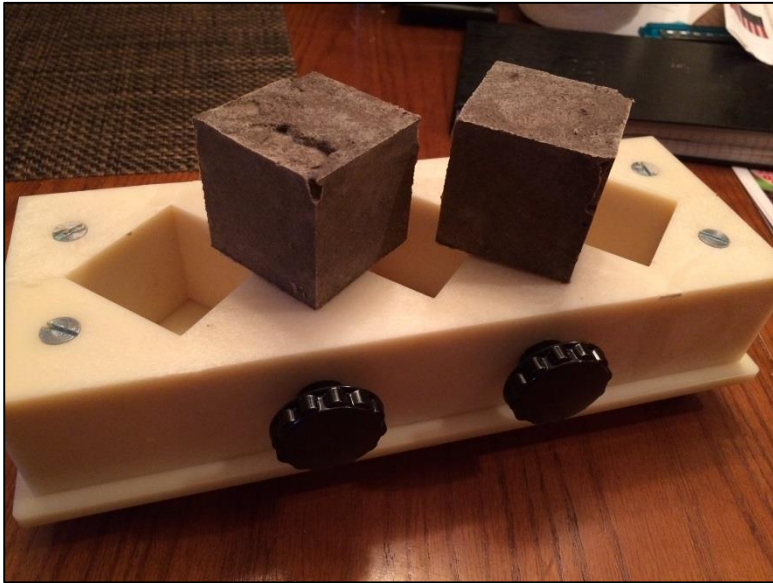

Test in 4602



Compression Test Samples



Sample prep in 4711
and 4464

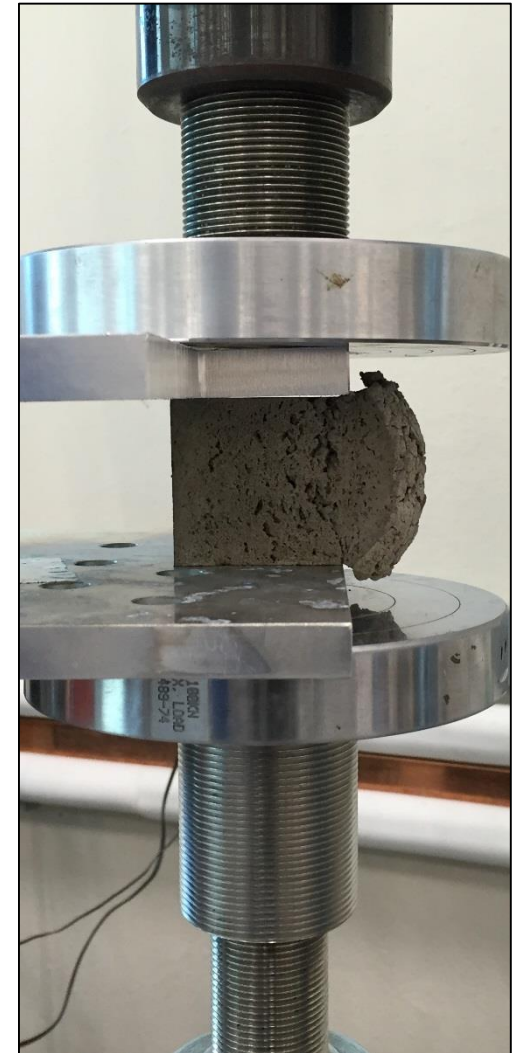

Test in 4602

Compression Test Results

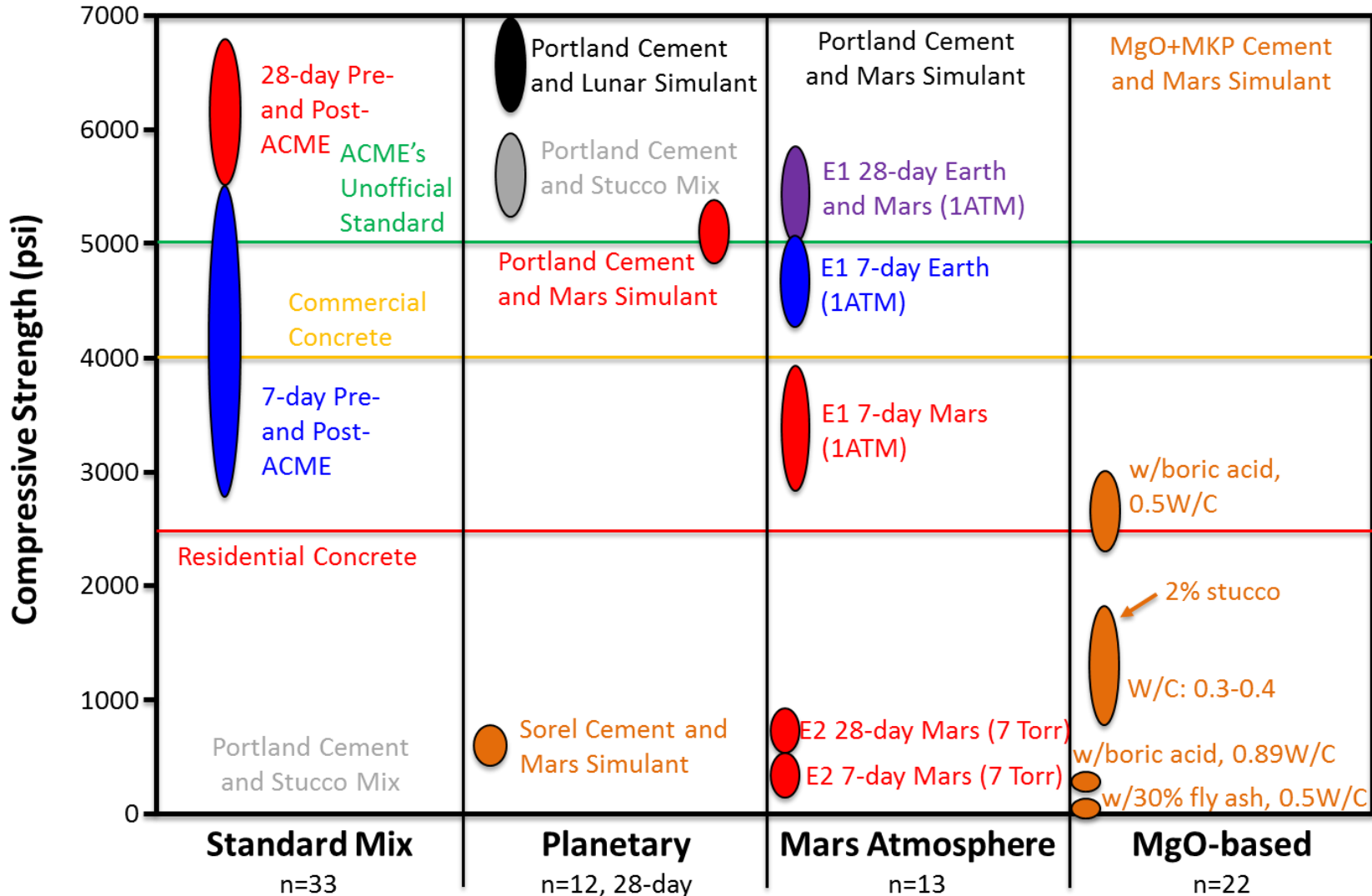

Hypervelocity Impact Test Samples

- Three samples were cast into 15.24cm x 15.24cm x 2.54cm molds



Martian simulant JSC Mars-1A, stucco mix, Portland cement, and water



Lunar simulant JSC-1A, stucco mix, Portland cement, and water



Martian simulant JSC Mars-1A, MgO-MKP cement, boric acid (set retardant*) and water – sample fractured during shipping to JSC prior to testing

*Set retardant used because this cement sets up very quickly and would solidify within the ACME system prior to extrusion

Hypervelocity Impact Test Samples

Martian simulant JSC Mars-1A, stucco mix, Portland cement, rheology control admixture, and water



2 vertical layers and 2 horizontal layers printed per day; material was allowed to dry between prints

25.40cm tall, 76.20cm long, 5.72cm thick wall

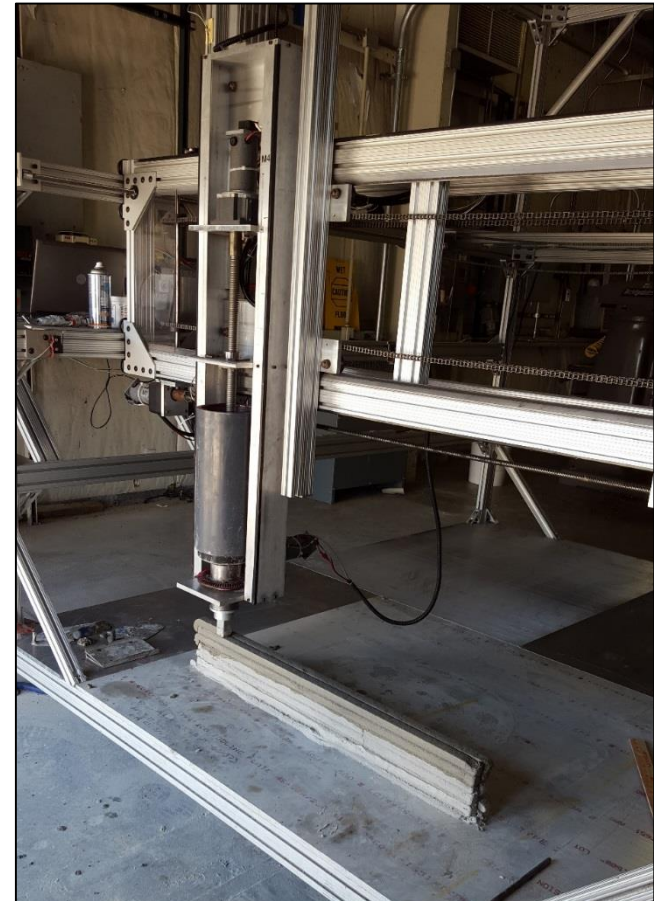

Hypervelocity Impact Test Samples

Martian simulatant JSC Mars-1A, stucco mix, Portland cement, rheology control admixture, and water

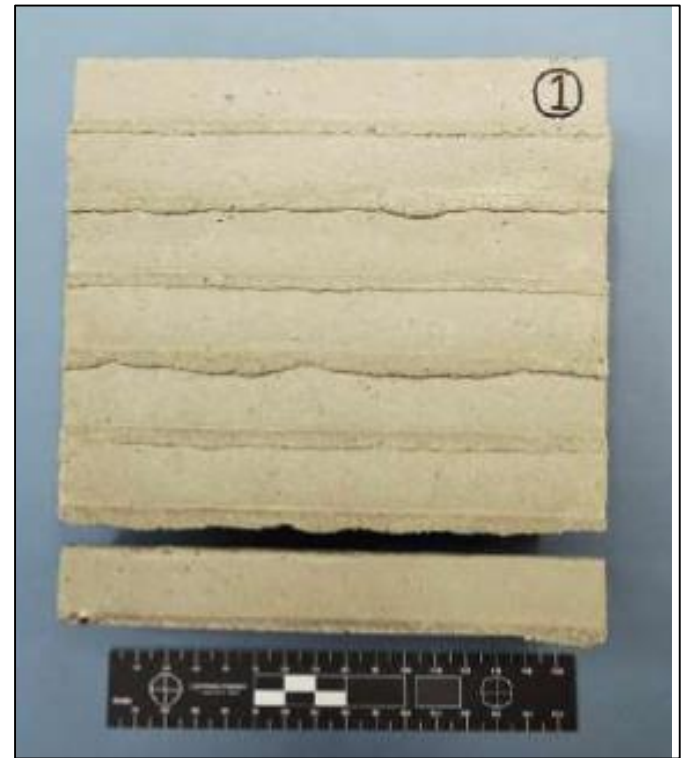
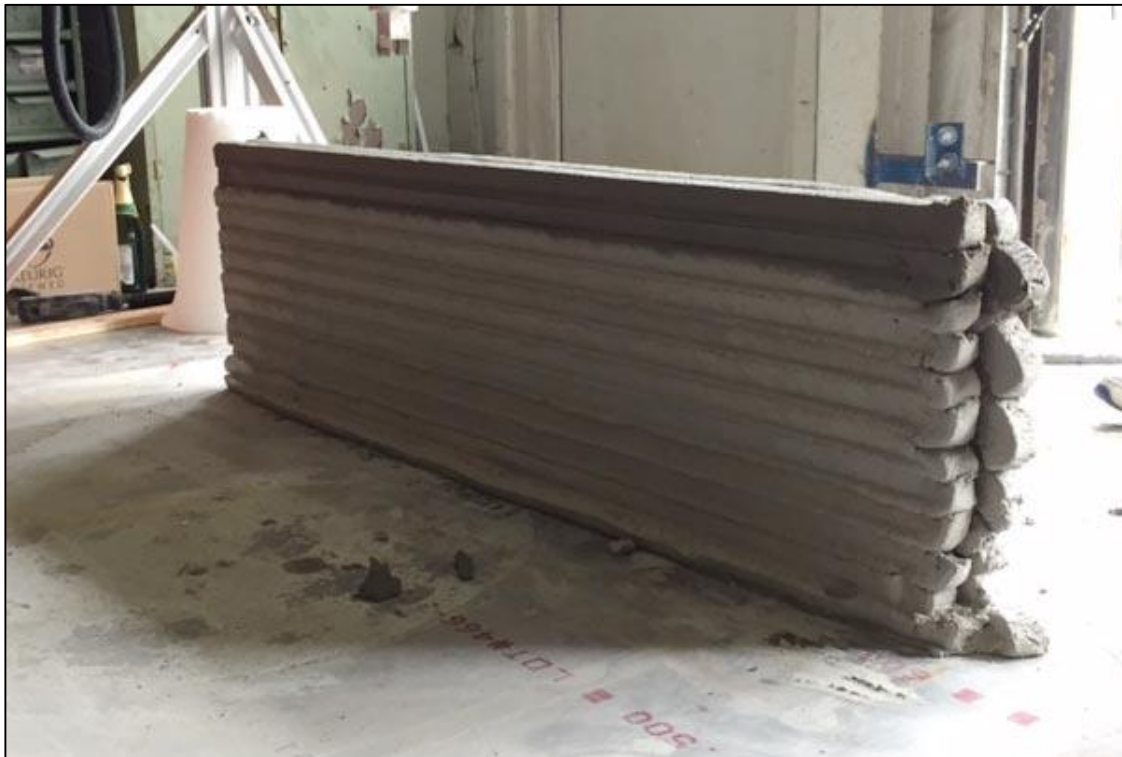

Sample delaminated during shipping to JSC on a boundary between prints made on different days

Hypervelocity Impact Testing

- Hypervelocity impact tests were internally funded and performed at the White Sands Test Facility in Las Cruces, NM
- 2.0mm Al 2017-T4 (density 2.796g/cm^3) impactor, 0.17-caliber light gas gun, 0° impact angle, 1Torr N_2 in chamber during test
- $7.0 \pm 0.2\text{km/s}$ velocity (approximate mean expected velocity of micrometeorites at the surface of Mars, and higher than expected velocity for bullets on Earth)
- Kinetic energy is equivalent to a micrometeorite with a density of 1g/cm^3 and a diameter of 0.1mm traveling at a velocity of 10.36km/s , as well as a 9x17mm Browning Short bullet.

Hypervelocity Impact Test Results

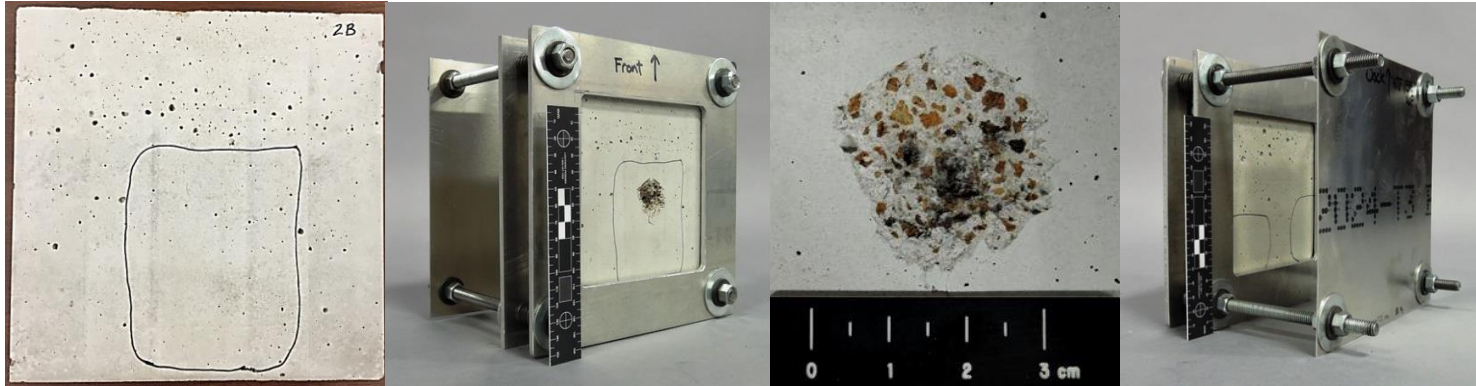

JSC Mars-1A
Portland cement
Stucco Mix
Water

Photos courtesy of the Johnson Space Center Hypervelocity Impact Technology Group

JSC Mars-1A
Portland cement
Stucco Mix
Admixture
(Rheology Control)
Water

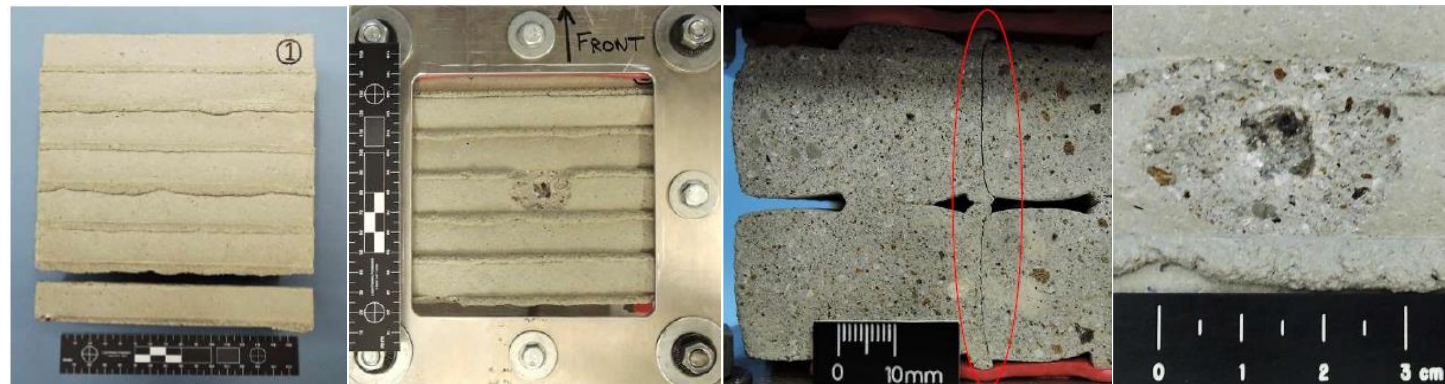

Hypervelocity Impact Test Results

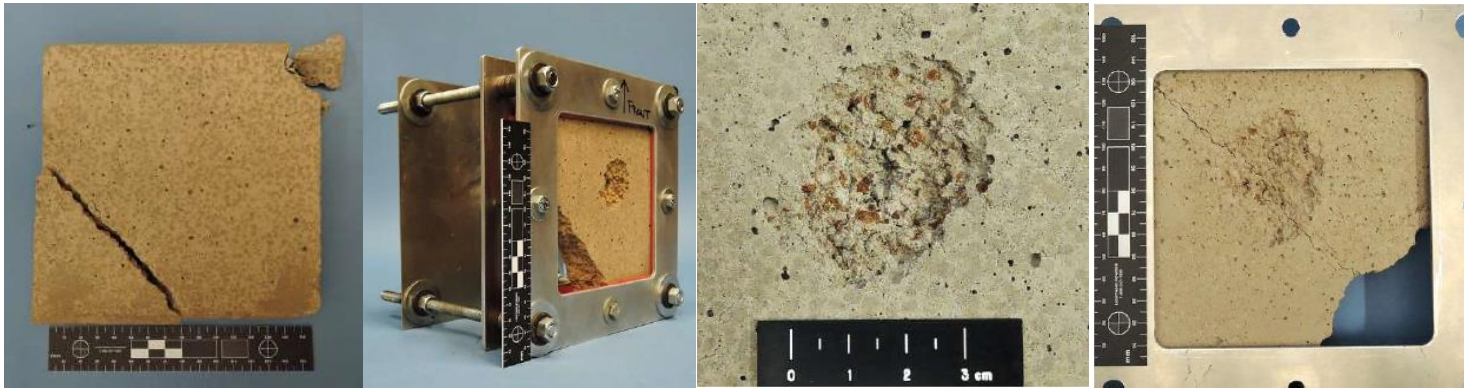

JSC Mars-1A
Sorel cement
(MgO + MKP)
Boric Acid (Set
Retardant)
Water

Photos courtesy of the Johnson Space Center Hypervelocity Impact Technology Group

JSC-1A
Portland cement
Stucco Mix
Water

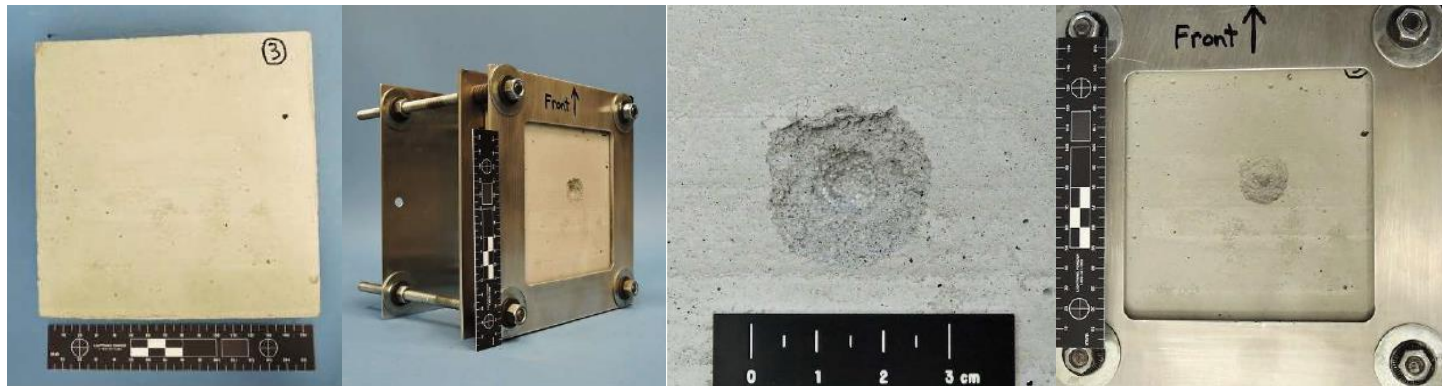

Future Work

- Continue to monitor human landing site workshops for Mars; optimize binder/regolith mixes for those sites
 - Continue to encourage planetary scientists to quantify available in-situ resources through remote sensing
- Establish an Artificial Neural Network to help optimize mixes
- Continue testing materials and identify promising new binders
- Spin-off technologies to industry
- Encourage involvement of the next generation in additive construction

3D Printed Habitat Challenge



<https://bradley.edu/sites/challenge/>