

National Aeronautics and Space Administration



# The Effectiveness of Shrouding on Reducing Meshed Spur Gear Power Loss Test Results

I. R. Delgado (NASA) and M. J. Hurrell (HX5 Sierra)

AGMA 2017 Fall Technical Meeting

Columbus, Ohio, USA, October 22-24, 2017



# Windage power loss (WPL)

- Definition
  - Drag on gear
  - Viscous drag on gear faces
  - Air/Oil impingement on tooth surface (inertia effects)
- Category
  - load-independent, spin-loss
- Significance
  - Occurs at greater than 10,000 ft./min. (51 m/s)
  - Gearbox efficiency losses
  - Reduced rotorcraft performance (i.e. payload, range)

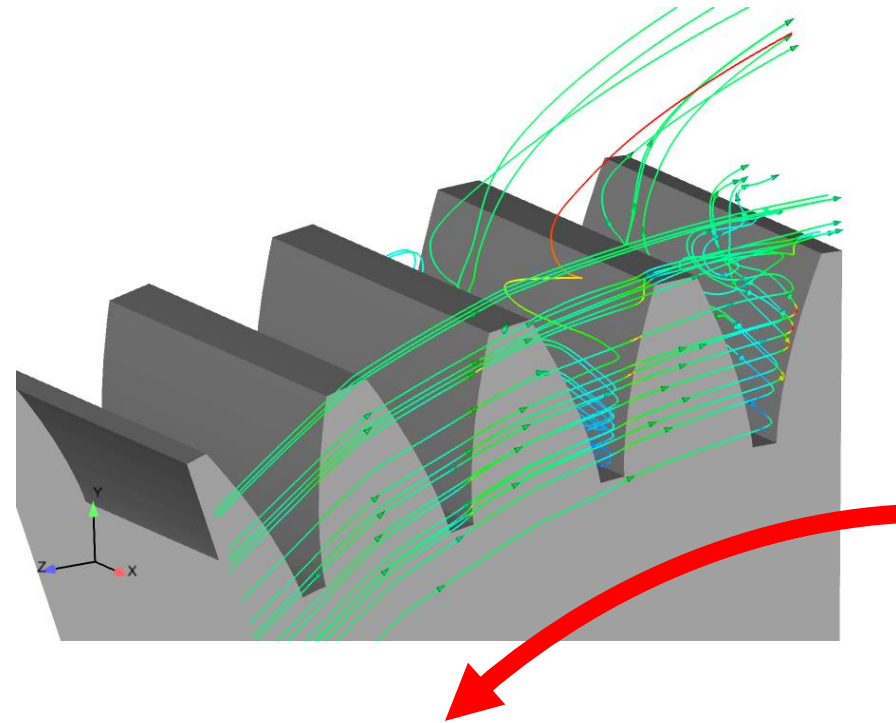

Ref:  
Hill, Matthew J., et al. "CFD analysis of gear windage losses: Validation and parametric aerodynamic studies." *Journal of Fluids Engineering* 133.3 (2011): 031103.

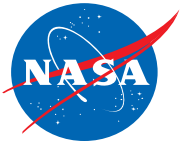

# Shrouded Spur Gear WPL Work

- (1984) Dawson: “Windage Loss in Larger High-Speed Gears”
  - single spur gears, air
  - reduction in WPL with axial and radial shrouding
- (1998) Lord: “An Experimental Investigation of Geometric and Oil Flow Effects on Gear Windage and Meshing Losses”
  - single and meshed spur gears, shrouding, air/oil
  - decrease in WPL with increasing oil temp., increase in WPL with increasing oil flow
- (2011) Combined Analysis & Experimental Validation
  - single spur gear analyses, shrouding
  - Hill: “CFD Analysis of Gear Windage Losses....”
  - Handschuh: “Initial Expts. of High-Speed Drive Sys. Windage Losses”
- (2017) Delgado and Hurrell: “Experimental Investigation of Shrouding on Meshed Spur Gear Windage Power Loss”
  - 7x to 12x increase in WPL for meshed spur gears compared to single spur gears
- (2017) Delgado and Hurrell: “Baseline Experimental Results on the Effect of Oil Temperature on Shrouded....”
  - WPL sensitivity to oil flow rate and oil temperature

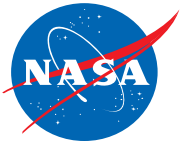

# Comparison - Shrouded Spur Gear WPL Data

Reference	Effect of Shrouding on WPL	Notes	environment	meshed spur gear?	diametral pitch	face width [in]	speed [ft./min.]	clearance	
								radial [in]	axial [in]
Dawson [5]	53% ↓	1, 2	air	n	3.175	7.4	?	0.59	1.06
Handschuh et al. [6]	~38% ↓	2	air	n	4	1	25,000	0.66	1.2
Lord [8]	~80% ↓	2	air	n	25.4	1.6	25,000	0.04	0.04
Lord [8]	~10X ↑	3	oil jet 0.66 gpm	n	25.4	1.6	25,000	0.04	0.04
Delgado et al. [11]	7x ↑	4	oil jet ~0.7 gpm	y	4	1	25,000	n/a	n/a
Delgado et al. [11]	12x ↑	5	oil jet ~0.9 gpm	y	4	1	25000	0.04	0.04

## Notes

- 1) 270° shroud sector
- 2) WPL comparison relative to unshrouded configuration.
- 3) WPL comparison relative to shrouded configuration in air.
- 4) WPL compared to single unshrouded of Handschuh et al. [6]
- 5) WPL compared to single shrouded of Handschuh et al. [6]

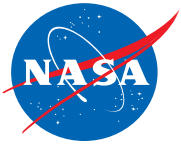

# Comparison - Shrouded Spur Gear WPL Data

Reference	Effect of Shrouding on WPL	Notes	environment	meshed spur gear?	diametral pitch	face width [in]	speed [ft./min.]	clearance	
								radial [in]	axial [in]
Dawson [5]	53% ↓	1, 2	air	n	3.175	7.4	?	0.59	1.06
Handschuh et al. [6]	~38% ↓	2	air	n	4	1	25,000	0.66	1.2
Lord [8]	~80% ↓	2	air	n	25.4	1.6	25,000	0.04	0.04
Lord [8]	~10X ↑	3	oil jet 0.66 gpm	n	25.4	1.6	25,000	0.04	0.04
Delgado et al. [11]	7x ↑	4	oil jet ~0.7 gpm	y	4	1	25,000	n/a	n/a
Delgado et al. [11]	12x ↑	5	oil jet ~0.9 gpm	y	4	1	25000	0.04	0.04

## Notes

- 1) 270° shroud sector
- 2) WPL comparison relative to unshrouded configuration.
- 3) WPL comparison relative to shrouded configuration in air.
- 4) WPL compared to single unshrouded of Handschuh et al. [6]
- 5) WPL compared to single shrouded of Handschuh et al. [6]

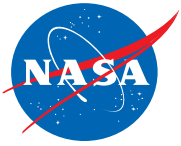

# Comparison - Shrouded Spur Gear WPL Data

Reference	Effect of Shrouding on WPL	Notes	environment	meshed spur gear?	diametral pitch	face width [in]	speed [ft./min.]	clearance	
								radial [in]	axial [in]
Dawson [5]	53% ↓	1, 2	air	n	3.175	7.4	?	0.59	1.06
Handschuh et al. [6]	~38% ↓	2	air	n	4	1	25,000	0.66	1.2
Lord [8]	~80% ↓	2	air	n	25.4	1.6	25,000	0.04	0.04
Lord [8]	~10X ↑	3	oil jet 0.66 gpm	n	25.4	1.6	25,000	0.04	0.04
Delgado et al. [11]	7x ↑	4	oil jet ~0.7 gpm	y	4	1	25,000	n/a	n/a
Delgado et al. [11]	12x ↑	5	oil jet ~0.9 gpm	y	4	1	25000	0.04	0.04

## Notes

- 1) 270° shroud sector
- 2) WPL comparison relative to unshrouded configuration.
- 3) WPL comparison relative to shrouded configuration in air.
- 4) WPL compared to single unshrouded of Handschuh et al. [6]
- 5) WPL compared to single shrouded of Handschuh et al. [6]

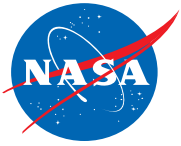

# Comparison - Shrouded Spur Gear WPL Data

Reference	Effect of Shrouding on WPL	Notes	environment	meshed spur gear?	diametral pitch	face width [in]	speed [ft./min.]	clearance	
								radial [in]	axial [in]
Dawson [5]	53% ↓	1, 2	air	n	3.175	7.4	?	0.59	1.06
Handschuh et al. [6]	~38% ↓	2	air	n	4	1	25,000	0.66	1.2
Lord [8]	~80% ↓	2	air	n	25.4	1.6	25,000	0.04	0.04
Lord [8]	~10X ↑	3	oil jet 0.66 gpm	n	25.4	1.6	25,000	0.04	0.04
Delgado et al. [11]	7x ↑	4	oil jet ~0.7 gpm	y	4	1	25,000	n/a	n/a
Delgado et al. [11]	12x ↑	5	oil jet ~0.9 gpm	y	4	1	25000	0.04	0.04

## Notes

- 1) 270° shroud sector
- 2) WPL comparison relative to unshrouded configuration.
- 3) WPL comparison relative to shrouded configuration in air.
- 4) WPL compared to single unshrouded of Handschuh et al. [6]
- 5) WPL compared to single shrouded of Handschuh et al. [6]

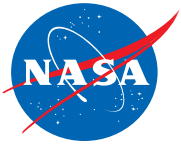

# Comparison - Shrouded Spur Gear WPL Data

Reference	Effect of Shrouding on WPL	Notes	environment	meshed spur gear?	diametral pitch	face width [in]	speed [ft./min.]	clearance	
								radial [in]	axial [in]
Dawson [5]	53% ↓	1, 2	air	n	3.175	7.4	?	0.59	1.06
Handschuh et al. [6]	~38% ↓	2	air	n	4	1	25,000	0.66	1.2
Lord [8]	~80% ↓	2	air	n	25.4	1.6	25,000	0.04	0.04
Lord [8]	~10X ↑	3	oil jet 0.66 gpm	n	25.4	1.6	25,000	0.04	0.04
Delgado et al. [11]	7x ↑	4	oil jet ~0.7 gpm	y	4	1	25,000	n/a	n/a
Delgado et al. [11]	12x ↑	5	oil jet ~0.9 gpm	y	4	1	25000	0.04	0.04

## Notes

- 1) 270° shroud sector
- 2) WPL comparison relative to unshrouded configuration.
- 3) WPL comparison relative to shrouded configuration in air.
- 4) WPL compared to single unshrouded of Handschuh et al. [6]
- 5) WPL compared to single shrouded of Handschuh et al. [6]



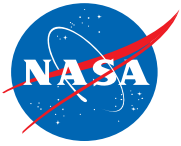

# WPL Research – Spur Gear, Air-Oil

	Single Spur Gear		Meshed Spur Gears	
	Unshrouded	Shrouded	Unshrouded	Shrouded
Experimental	<ul style="list-style-type: none"><li>• Handschuh (2011)</li><li>• Polly (2013)</li></ul>	<ul style="list-style-type: none"><li>• Lord (1998)</li><li>• Handschuh (2011)</li></ul>	<ul style="list-style-type: none"><li>• Petry-Johnson (2008)</li><li>• Seetharaman (2009)</li><li>• Polly (2013)</li><li>• Delgado (2017)</li></ul>	<ul style="list-style-type: none"><li>• Delgado (2017)</li></ul>
Analytical	<ul style="list-style-type: none"><li>• Hill (2012)</li><li>• Kunz (2012)</li><li>• Chaari (2012)</li><li>• Gorla (2012)</li></ul>	<ul style="list-style-type: none"><li>• Hill (2012)</li><li>• Kunz (2012)</li></ul>	<ul style="list-style-type: none"><li>• Seetharaman (2009)</li><li>• Burberi (2016)</li></ul>	None

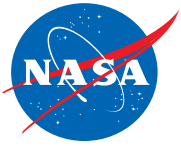

# Focus of this Effort

- Obtain WPL experimental data on meshed spur gears at intermediate shroud conditions
  - Constant oil inlet temperature: 100°F (38°C)
  - Constant oil pressure and flow
  - 4 shroud configurations
    - Max axial, Max radial
    - Min axial, Min radial
    - Max axial, Min radial
    - Min axial, Max radial
- Identify WPL trends, if any
- Suggestions for additional research

# NASA Windage Power Loss Test Rig

- dc motor:
  - 150 hp (112 kW)
- speed-up gearbox:
  - 1:5.17 ratio
- torque-meter:
  - 2,000 in-lbs (226 N-m)
- Eddy-current brake:
  - 73.8 ft.-lb. (100 N-m) at 2865 rpm (300 rad./sec.)
- Friction clutches
  - Disengage test gearbox from drive/brake system
- Into-mesh lubrication
- Measurements
  - shaft speed
  - gear fling-off temperature
  - gear mesh oil flow
  - oil inlet/exit temperature

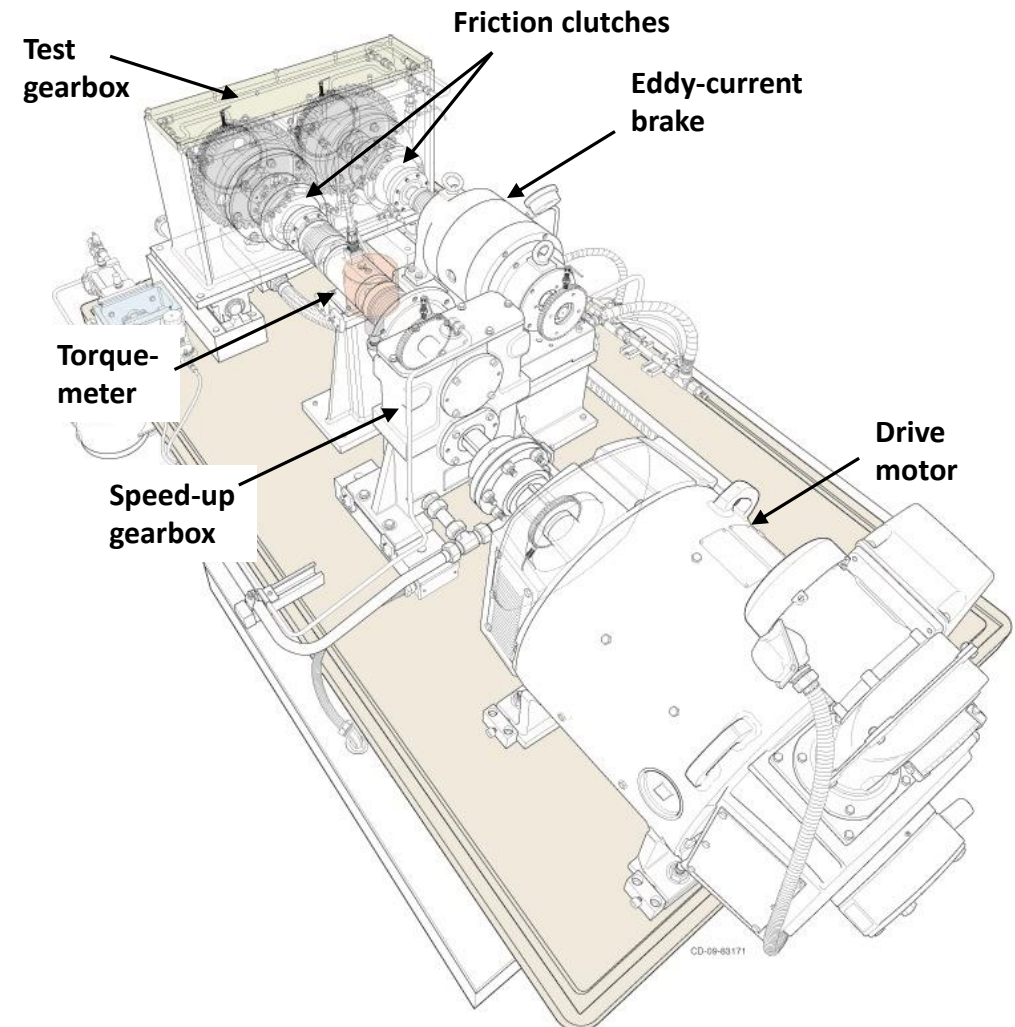

# Gear Information

Gear Parameter	Drive-side	Driven-side
Number of teeth	44	52
Pitch / module, 1/in. (mm)	4 (6.35)	
Face Width in. (mm)	1.12 (28.4)	1.12 (28.4)
Pitch Diameter, in. (mm)	11.0 (279.4)	13.0 (330.2)
Pressure Angle, deg.	25	
Outside Diameter, in. (mm)	11.49 (291.85)	13.49 (342.65)
Material	Steel-SAE 5150H	



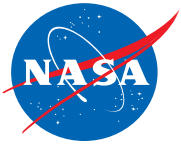

# Shrouding Assembly

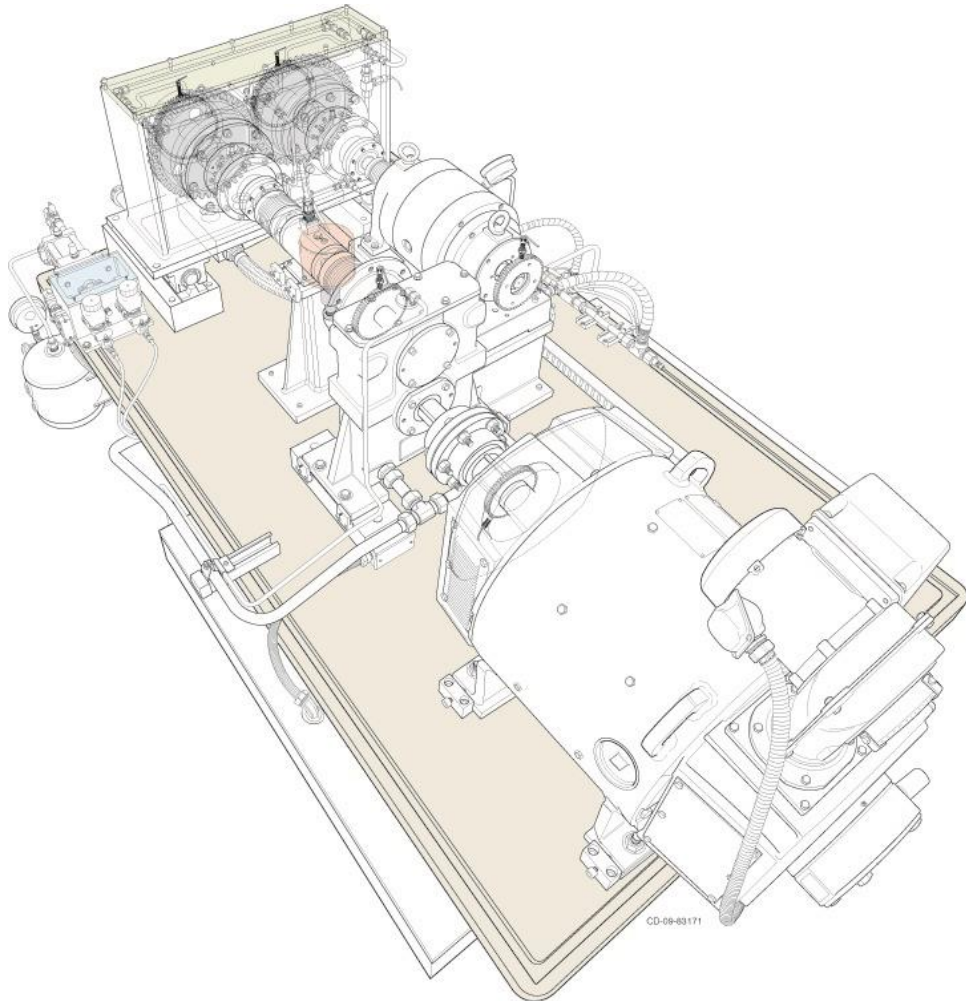

# Shrouding Assembly

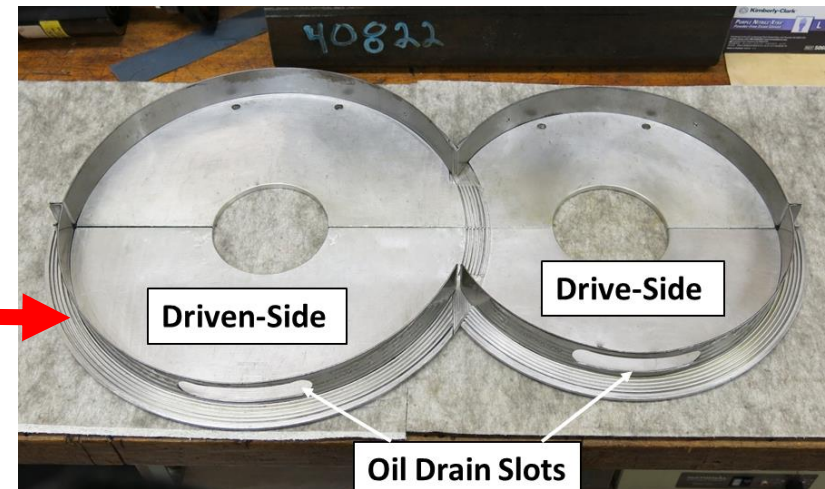
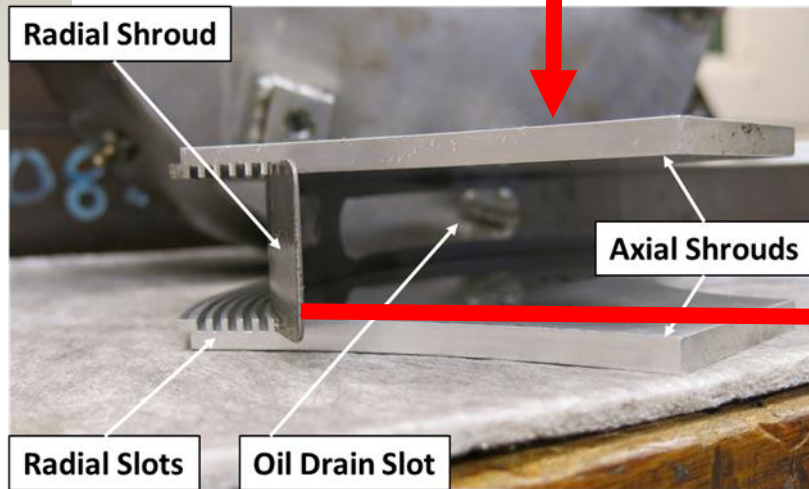
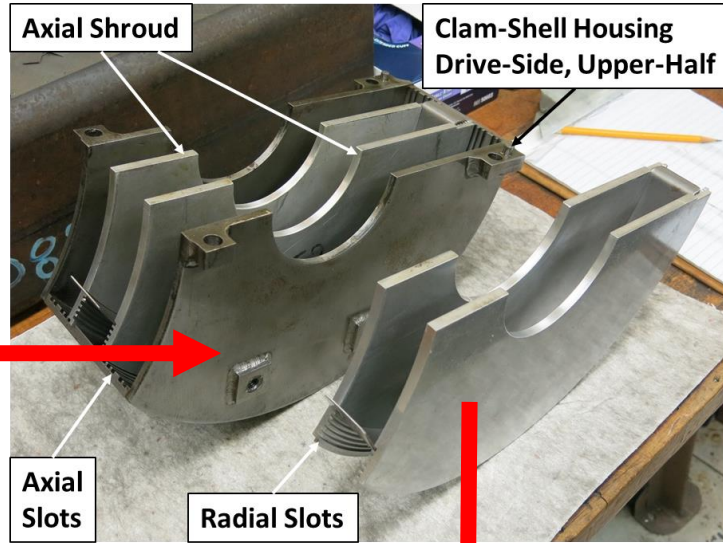
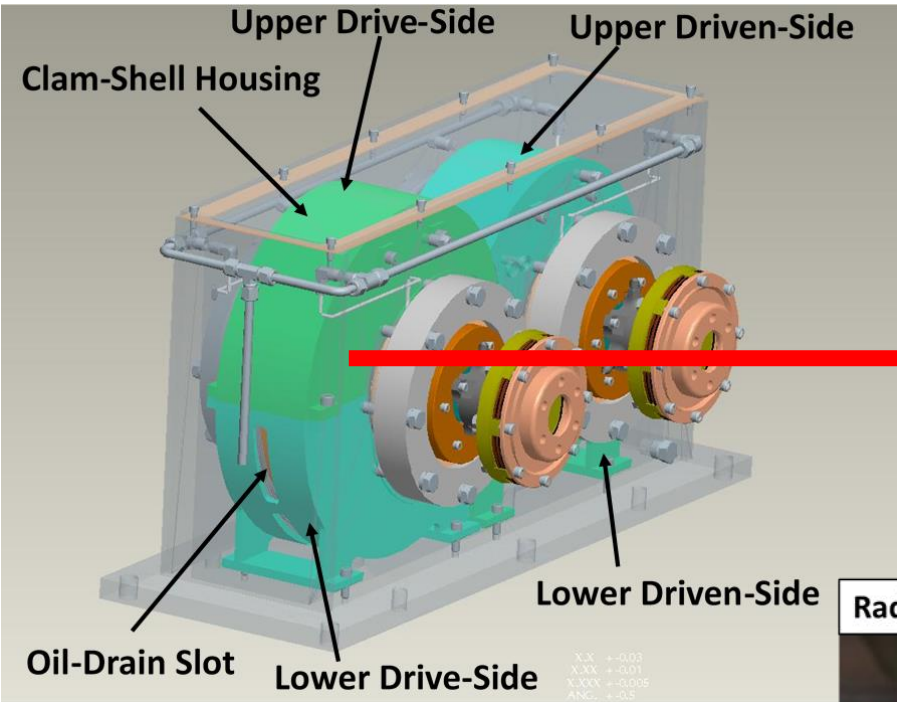

# Shrouding Assembly

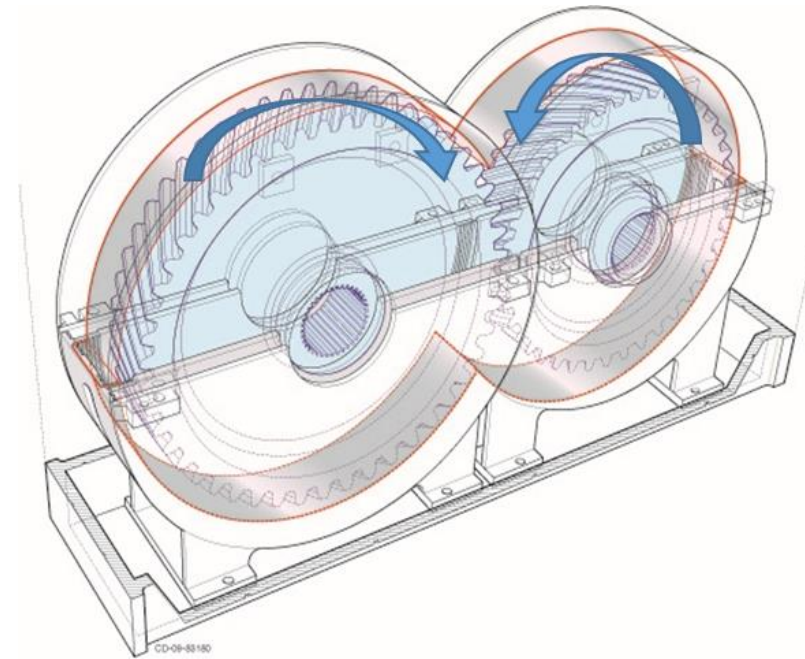
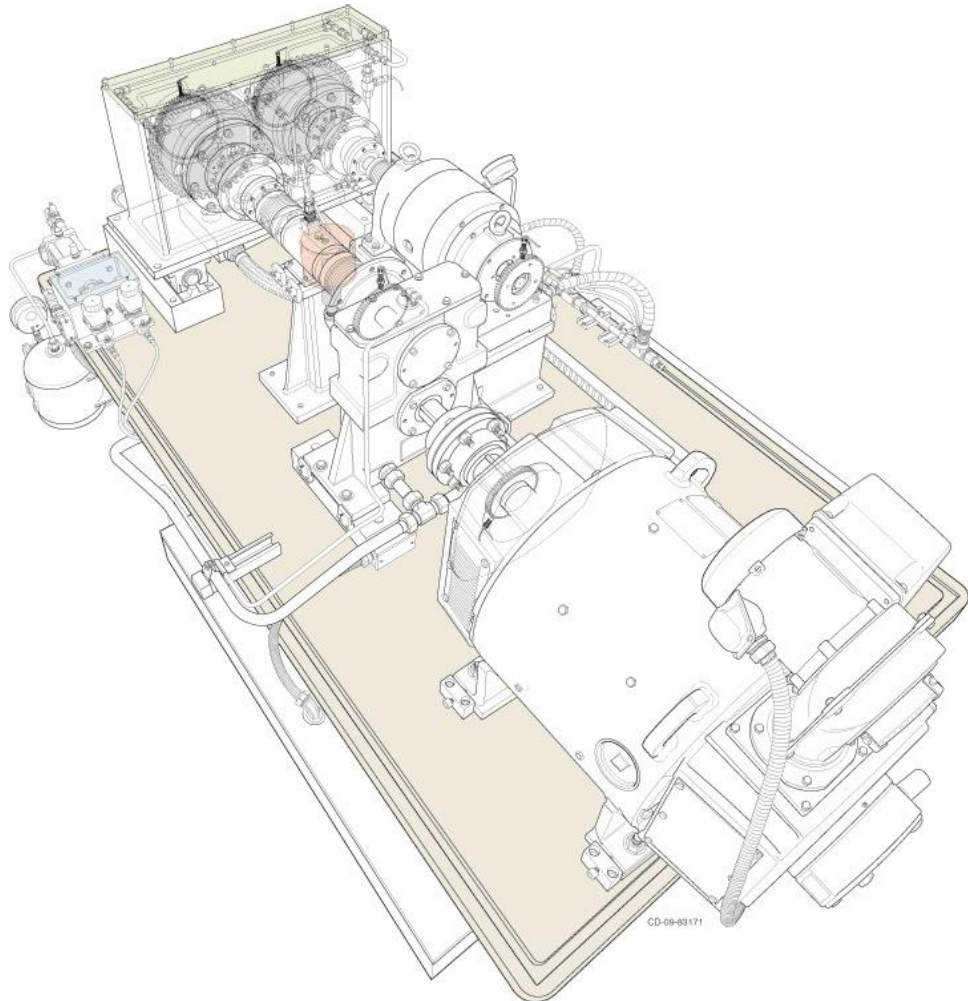

# Shrouding Configurations

Shroud Configuration	Axial Clearance	Radial Clearance	
	Per side [inches] (mm)	Drive [inches] (mm)	Driven [inches] (mm)
<b>(U) Unshrouded w/o clam-shell housing</b>	2.25 (57)	2.5 (64)	1.0 (25.4)
<b>(CS) Unshrouded w/ clam-shell housing</b>	1.5 (38)	0.8 (21)	0.8 (21)
<b>(C36) shrouded</b>	1.2 (31)	0.66 (17)	0.66 (17)
<b>(C1) shrouded</b>	0.04 (1)	0.04 (1)	0.04 (1)
<b>(C6) shrouded</b>	0.04 (1)	0.66 (17)	0.66 (17)
<b>(C31) shrouded</b>	1.2 (31)	0.04 (1)	0.04 (1)

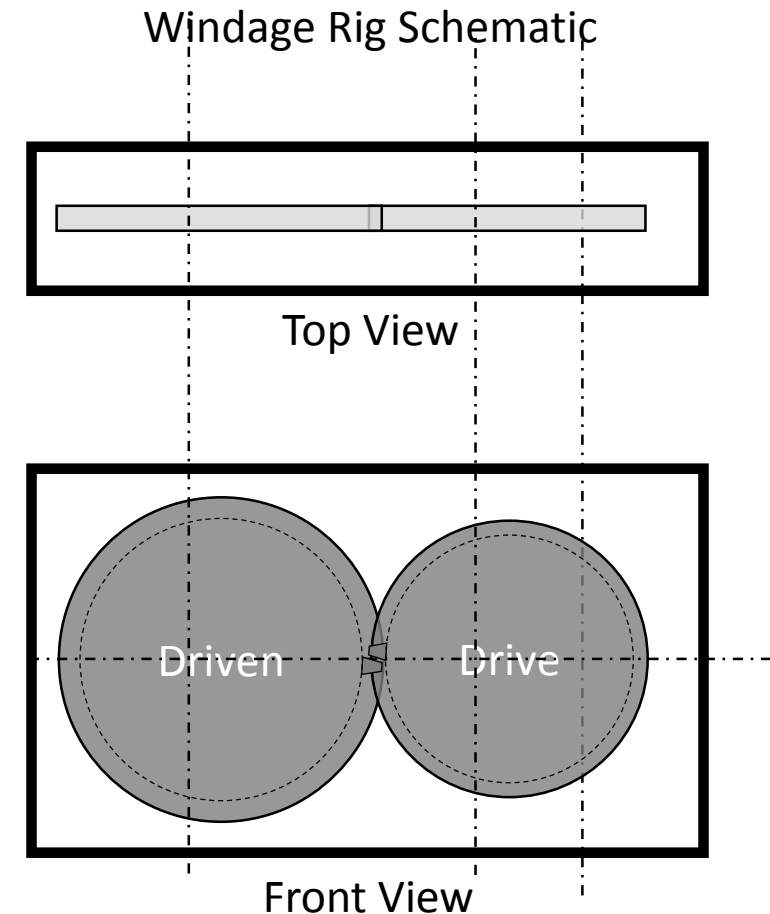



# Shrouding Configurations

Shroud Configuration	Axial Clearance	Radial Clearance	
	Per side [inches] (mm)	Drive [inches] (mm)	Driven [inches] (mm)
(U) Unshrouded w/o clam-shell housing	2.25 (57)	2.5 (64)	1.0 (25.4)
<b>(CS) Unshrouded w/ clam-shell housing</b>	<b>1.5 (38)</b>	<b>0.8 (21)</b>	<b>0.8 (21)</b>
(C36) shrouded	1.2 (31)	0.66 (17)	0.66 (17)
(C1) shrouded	0.04 (1)	0.04 (1)	0.04 (1)
(C6) shrouded	0.04 (1)	0.66 (17)	0.66 (17)
(C31) shrouded	1.2 (31)	0.04 (1)	0.04 (1)

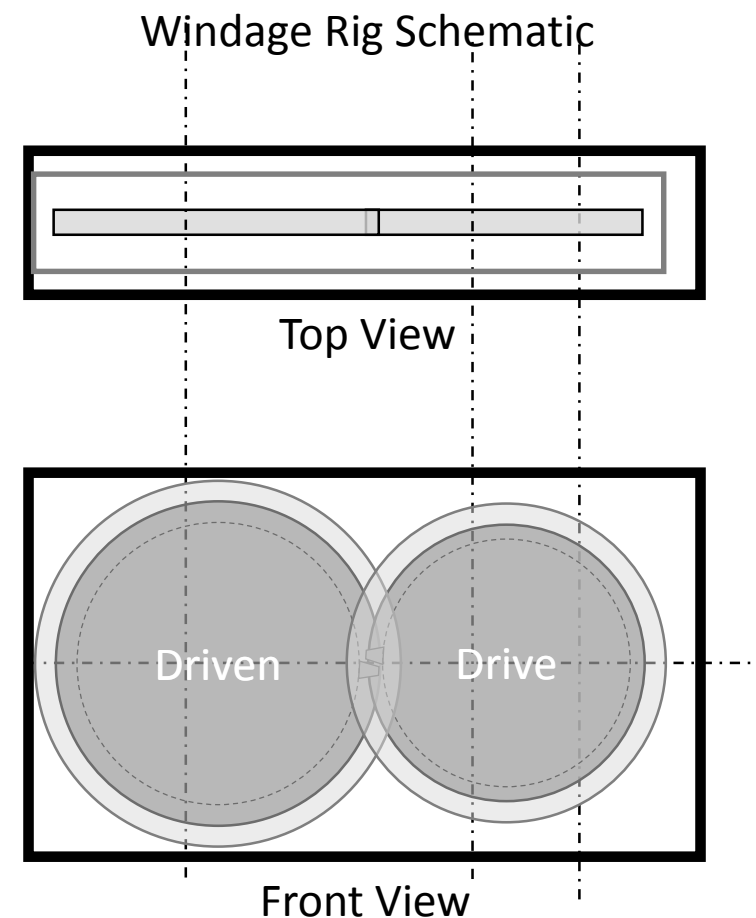

# Shrouding Configurations

Shroud Configuration	Axial Clearance	Radial Clearance	
	Per side [inches] (mm)	Drive [inches] (mm)	Driven [inches] (mm)
(U) Unshrouded w/o clam-shell housing	2.25 (57)	2.5 (64)	1.0 (25.4)
(CS) Unshrouded w/ clam-shell housing	1.5 (38)	0.8 (21)	0.8 (21)
<b>(C36) shrouded</b>	<b>1.2 (31)</b>	<b>0.66 (17)</b>	<b>0.66 (17)</b>
(C1) shrouded	0.04 (1)	0.04 (1)	0.04 (1)
(C6) shrouded	0.04 (1)	0.66 (17)	0.66 (17)
(C31) shrouded	1.2 (31)	0.04 (1)	0.04 (1)

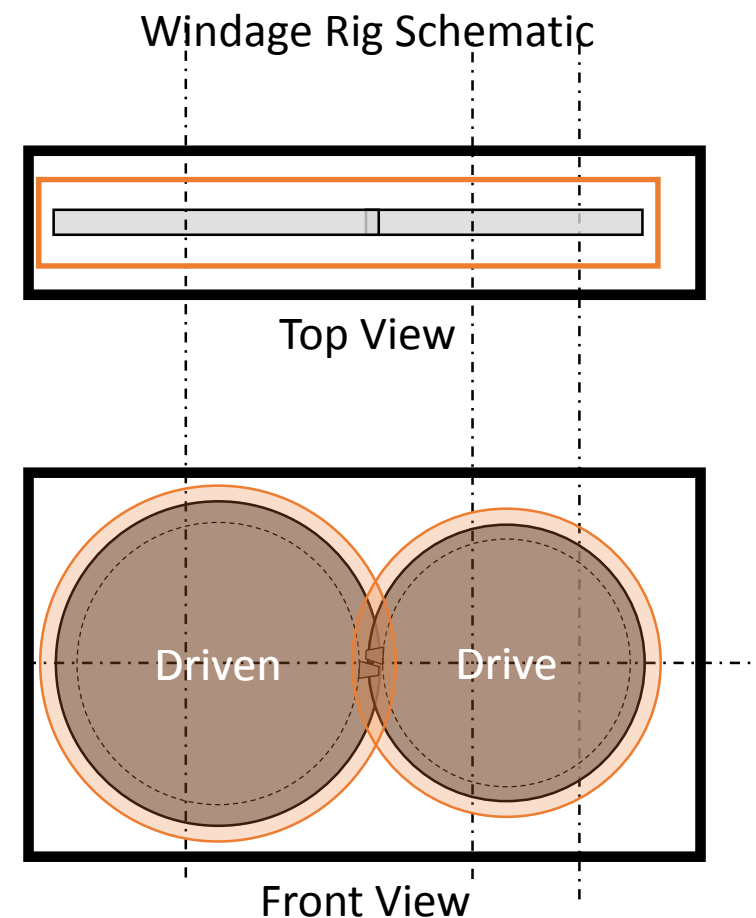

# Shrouding Configurations

Shroud Configuration	Axial Clearance	Radial Clearance	
	Per side [inches] (mm)	Drive [inches] (mm)	Driven [inches] (mm)
(U) Unshrouded w/o clam-shell housing	2.25 (57)	2.5 (64)	1.0 (25.4)
(CS) Unshrouded w/ clam-shell housing	1.5 (38)	0.8 (21)	0.8 (21)
(C36) shrouded	1.2 (31)	0.66 (17)	0.66 (17)
<b>(C1) shrouded</b>	<b>0.04 (1)</b>	<b>0.04 (1)</b>	<b>0.04 (1)</b>
(C6) shrouded	0.04 (1)	0.66 (17)	0.66 (17)
(C31) shrouded	1.2 (31)	0.04 (1)	0.04 (1)

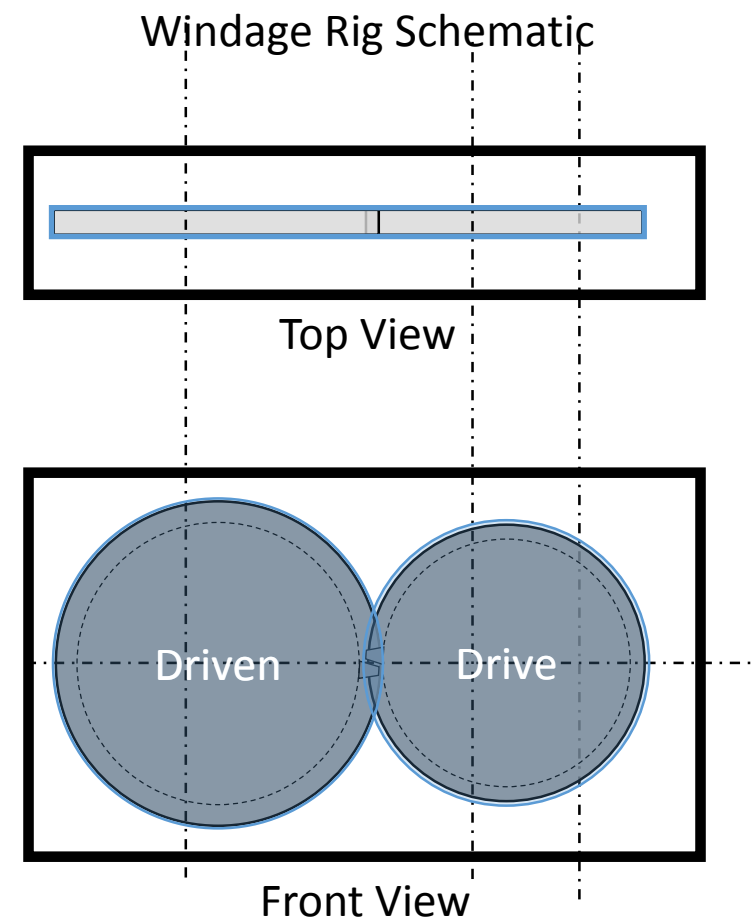

# Shrouding Configurations

Shroud Configuration	Axial Clearance	Radial Clearance	
	Per side [inches] (mm)	Drive [inches] (mm)	Driven [inches] (mm)
(U) Unshrouded w/o clam-shell housing	2.25 (57)	2.5 (64)	1.0 (25.4)
(CS) Unshrouded w/ clam-shell housing	1.5 (38)	0.8 (21)	0.8 (21)
(C36) shrouded	1.2 (31)	0.66 (17)	0.66 (17)
(C1) shrouded	0.04 (1)	0.04 (1)	0.04 (1)
<b>(C6) shrouded</b>	<b>0.04 (1)</b>	<b>0.66 (17)</b>	<b>0.66 (17)</b>
(C31) shrouded	1.2 (31)	0.04 (1)	0.04 (1)

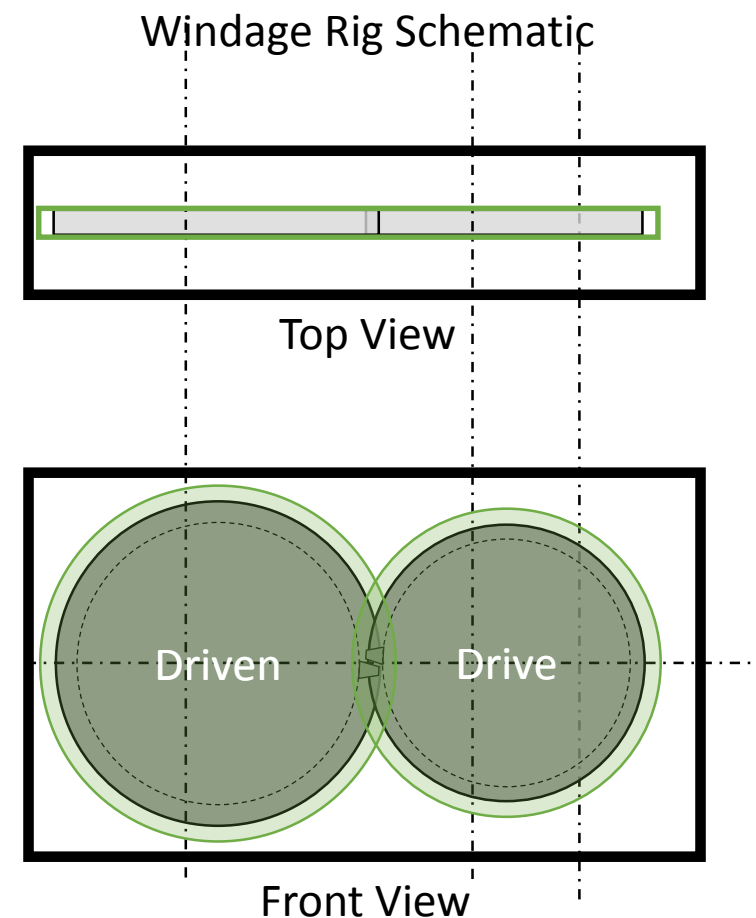

# Shrouding Configurations

Shroud Configuration	Axial Clearance	Radial Clearance	
	Per side [inches] (mm)	Drive [inches] (mm)	Driven [inches] (mm)
(U) Unshrouded w/o clam-shell housing	2.25 (57)	2.5 (64)	1.0 (25.4)
(CS) Unshrouded w/ clam-shell housing	1.5 (38)	0.8 (21)	0.8 (21)
(C36) shrouded	1.2 (31)	0.66 (17)	0.66 (17)
(C1) shrouded	0.04 (1)	0.04 (1)	0.04 (1)
(C6) shrouded	0.04 (1)	0.66 (17)	0.66 (17)
<b>(C31) shrouded</b>	<b>1.2 (31)</b>	<b>0.04 (1)</b>	<b>0.04 (1)</b>

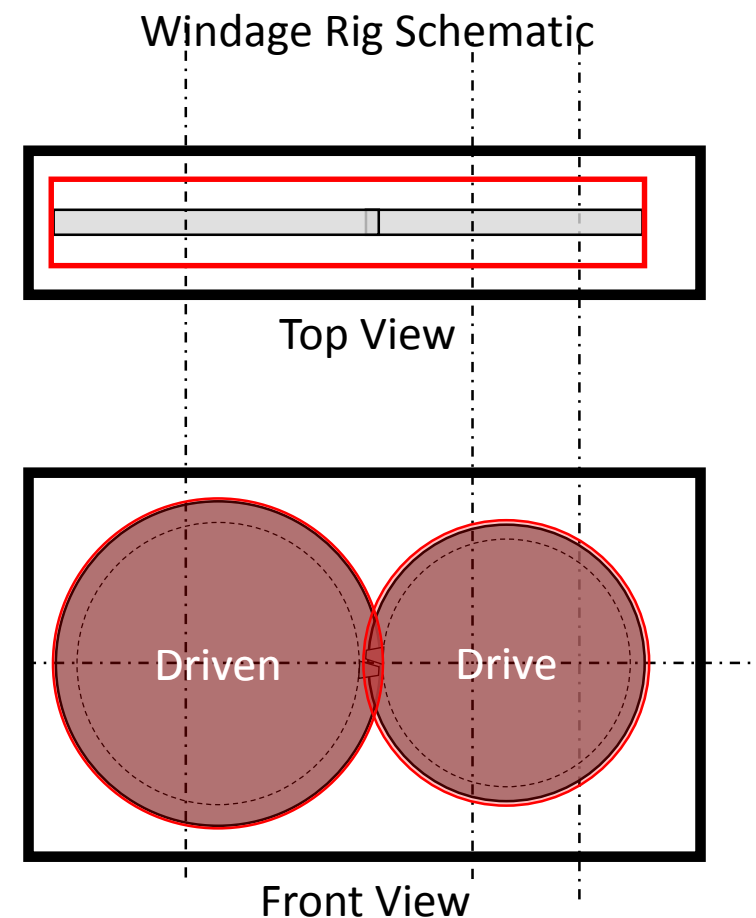

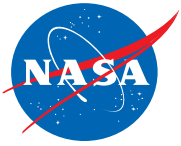

# Windage Power Loss Test Procedure

- Ramp up
  - 2000 rpm increments every 100 seconds
  - Up to 10,000 rpm (1047 rad/s)
- Spin-down at 10,000 rpm (1047 rad/s)
  - disengage via clutches the drive motor and dynamometer
  - Record speed vs time
- Repeat 2x for 3 cycles total.
- Oil Inlet Temperature:
  - 100°F (38°C)
- Shroud Config
  - U, CS, C1, C6, C31, C36

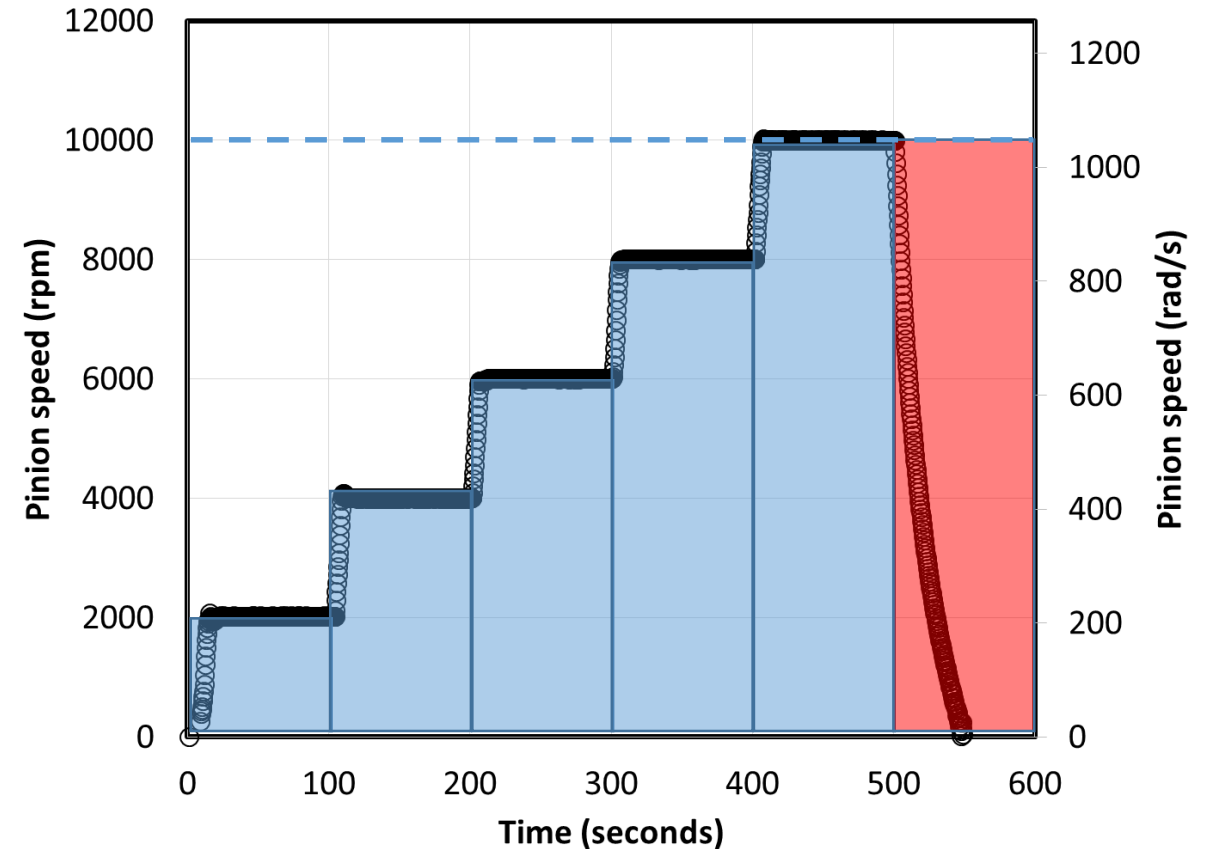

# Windage Power Loss Calculation

- $WPL = P_{total} - P_{gear\ mesh} - P_{driveline\ losses}$
- $P_{total} = (\tau_{system} [ft-lbf] \times N [rpm]) \div 5252$ 
  - $\tau_{system} = I_{system} \times \alpha_{system}$
  - $I_{system}$  (equivalent inertia for meshed spur gears)
  - $\alpha_{system}$  via experiment
- $P_{gear\ mesh}$  (estimated via NASA TP 1622, minimal, 1%)
- $P_{driveline\ losses} = (\tau_{driveline} [ft-lbf] \times N [rpm]) \div 5252$ 
  - $\tau_{driveline} = I_{driveline} \times \alpha_{driveline}$
  - $I_{driveline}$  (curved rail method by Genta)
  - $\alpha_{driveline}$  via experiment



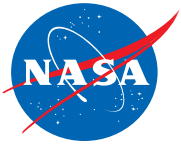

# Effect of wind-down cycles on WPL

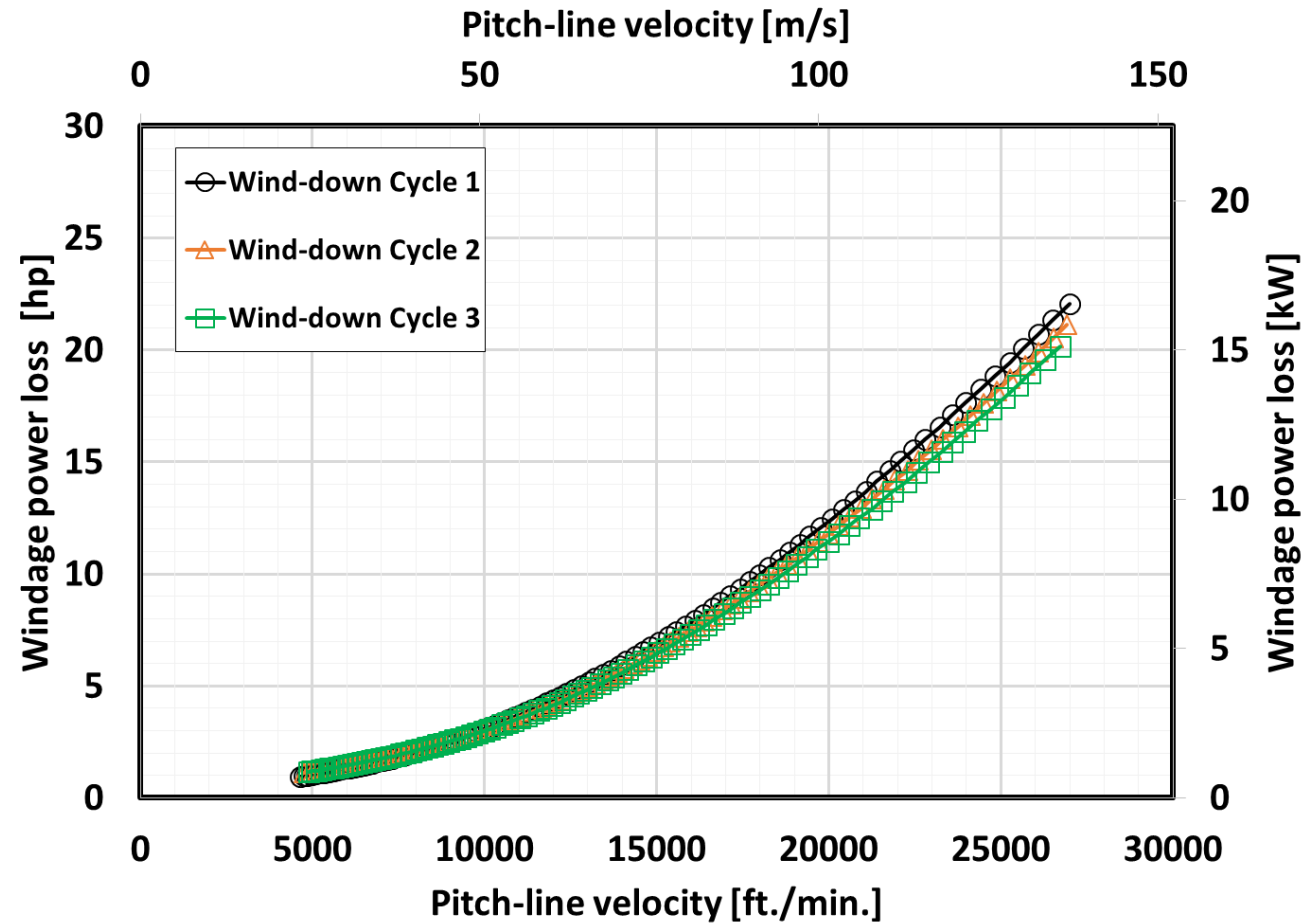



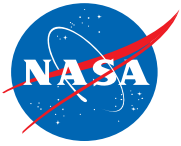

# Avg. Oil Temps. and Oil Flows vs. Shroud Configuration

Shroud Configuration	oil inlet temp. [°F] (°C)	oil out temp. [°F] (°C)	gear oil-flow [gpm] (lpm)	bearing oil-flow [gpm] (lpm)
(U) unshrouded	107 (41)	163 (73)	0.91 (4.1)	0.27 (1.2)
(CS) unshrouded with clam-shell housing	102 (39)	162 (72)	0.90 (4.1)	0.14 (0.6)
(C1) shrouded	109 (43)	143 (62)	0.91 (4.1)	0.18 (0.8)
(C6) shrouded	107 (41)	151 (66)	0.91 (4.1)	0.19 (0.9)
(C31) shrouded	101 (38)	137 (58)	1.07 (4.9)	0.18 (0.8)
(C36) shrouded	101 (38)	144 (62)	0.85 (3.9)	0.19 (0.9)

# WPL versus Shroud Configuration

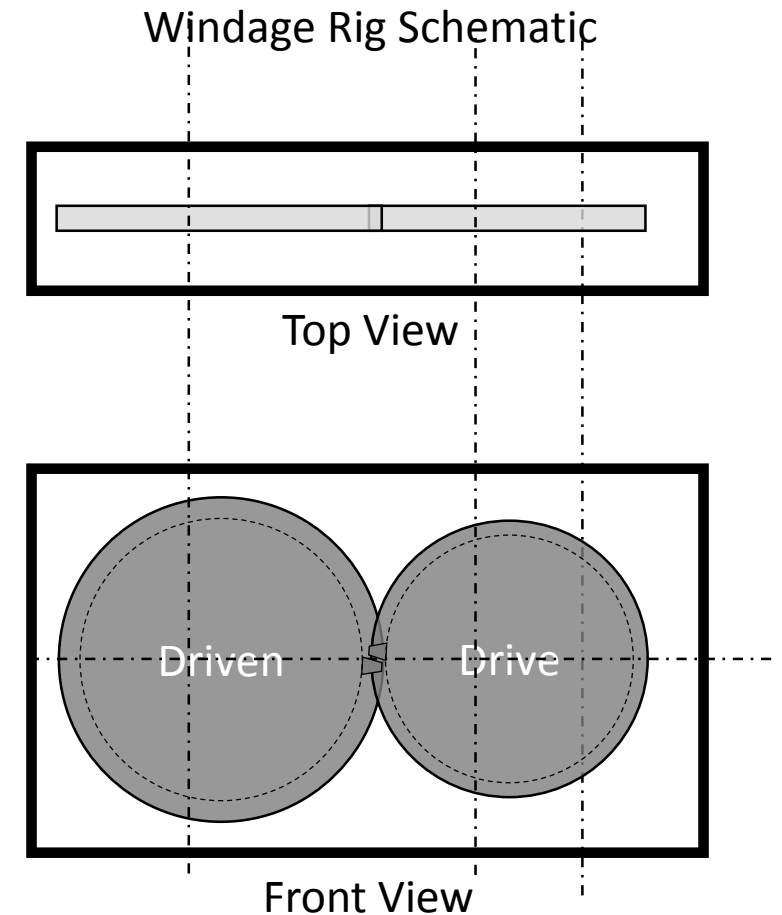
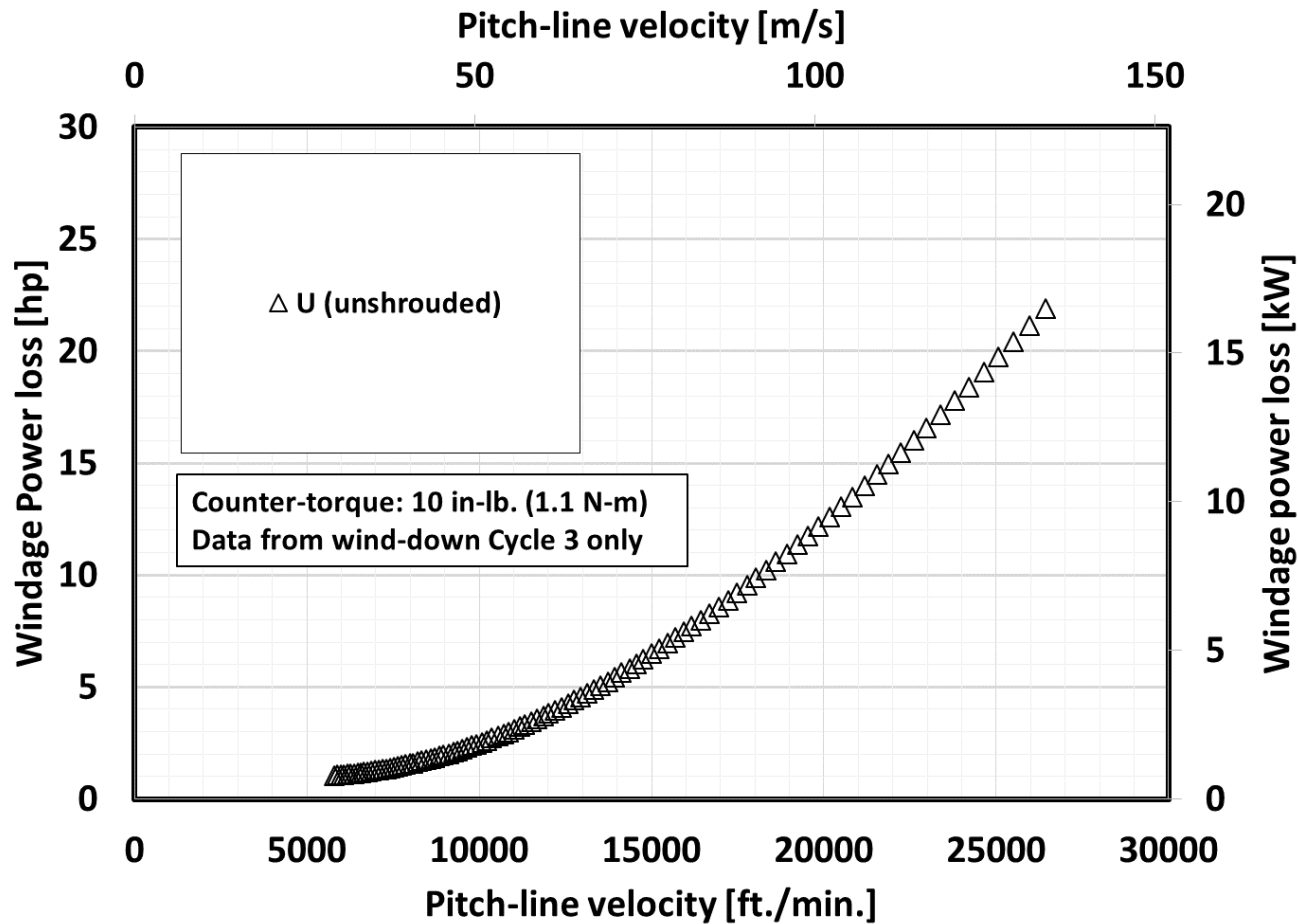

# WPL versus Shroud Configuration

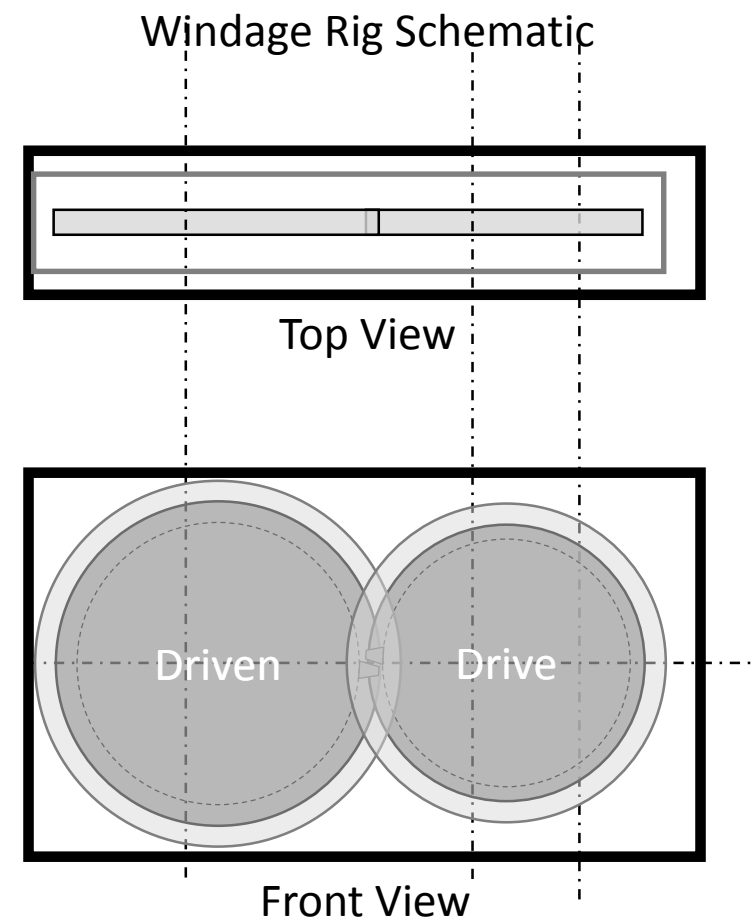
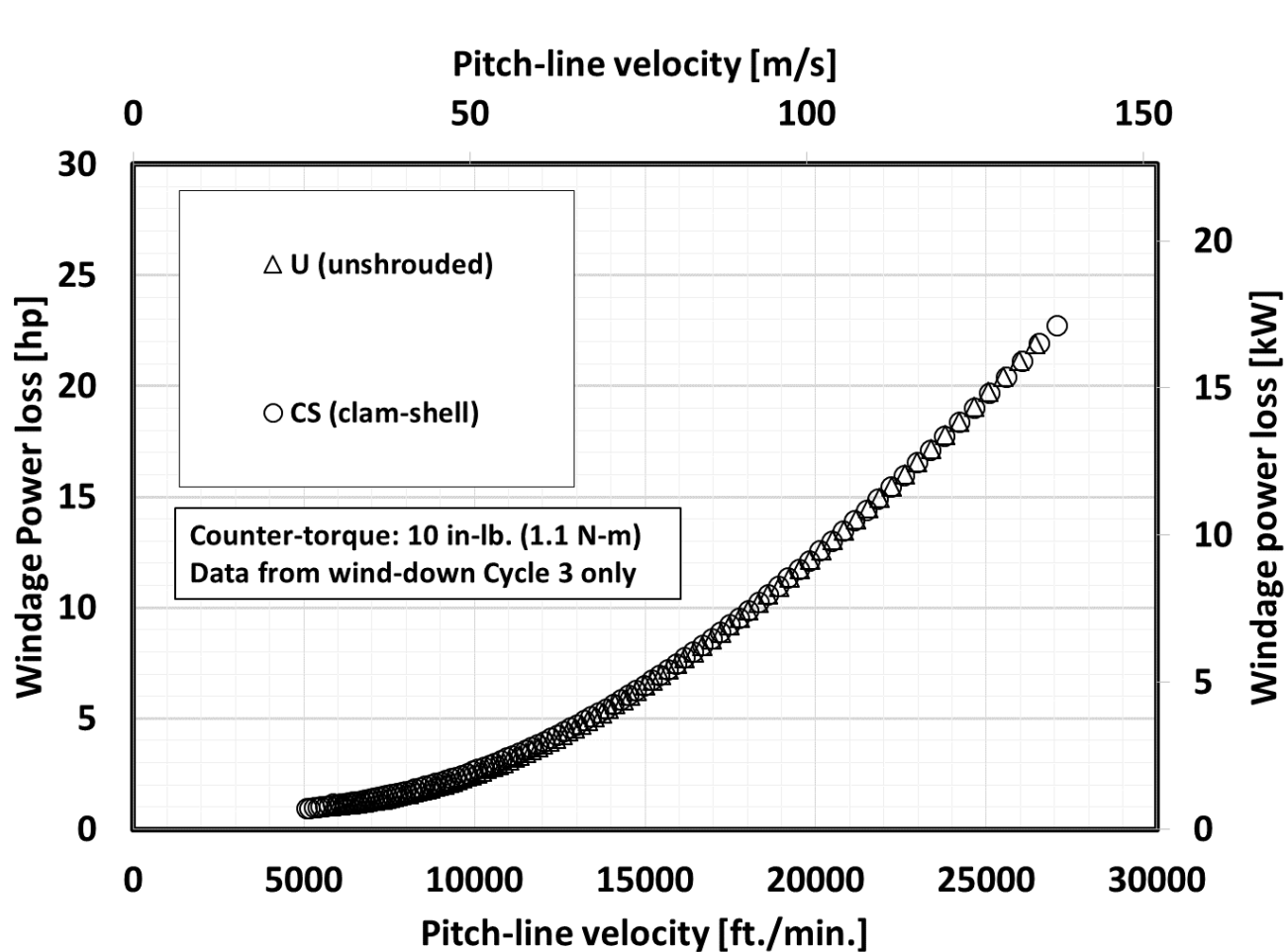

# WPL versus Shroud Configuration

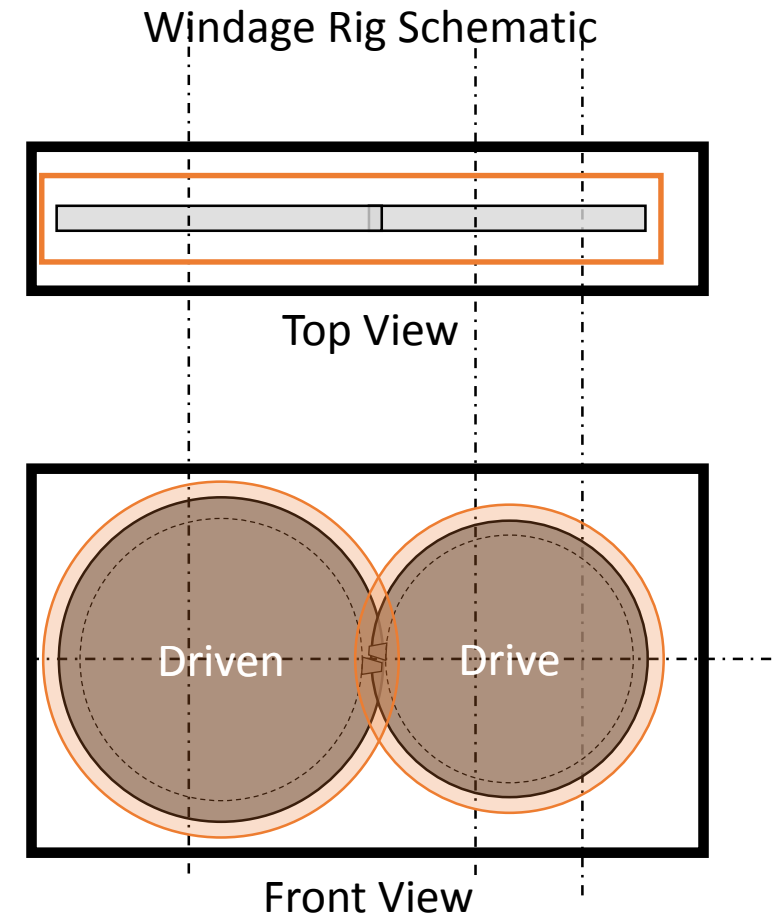
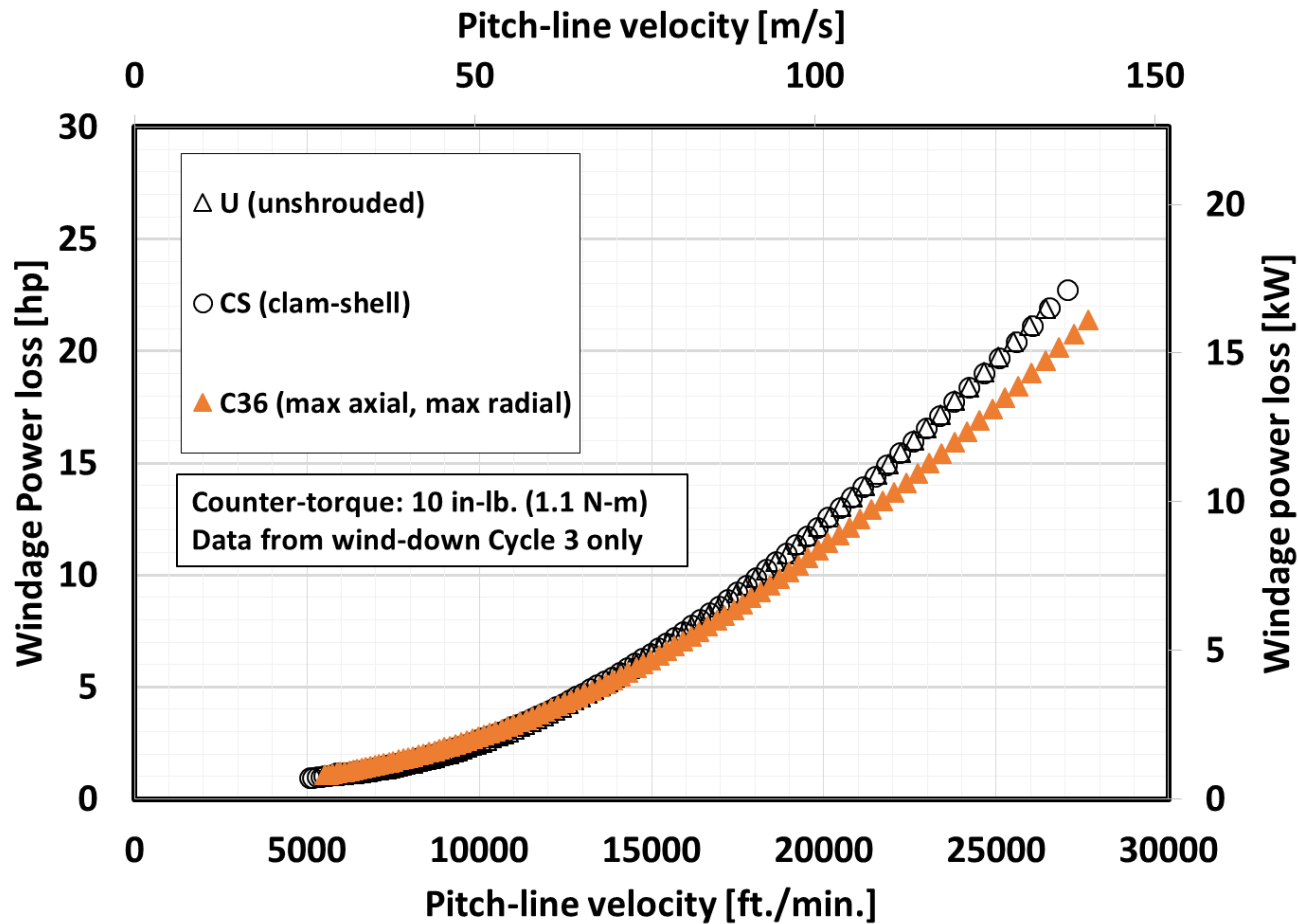

# WPL versus Shroud Configuration

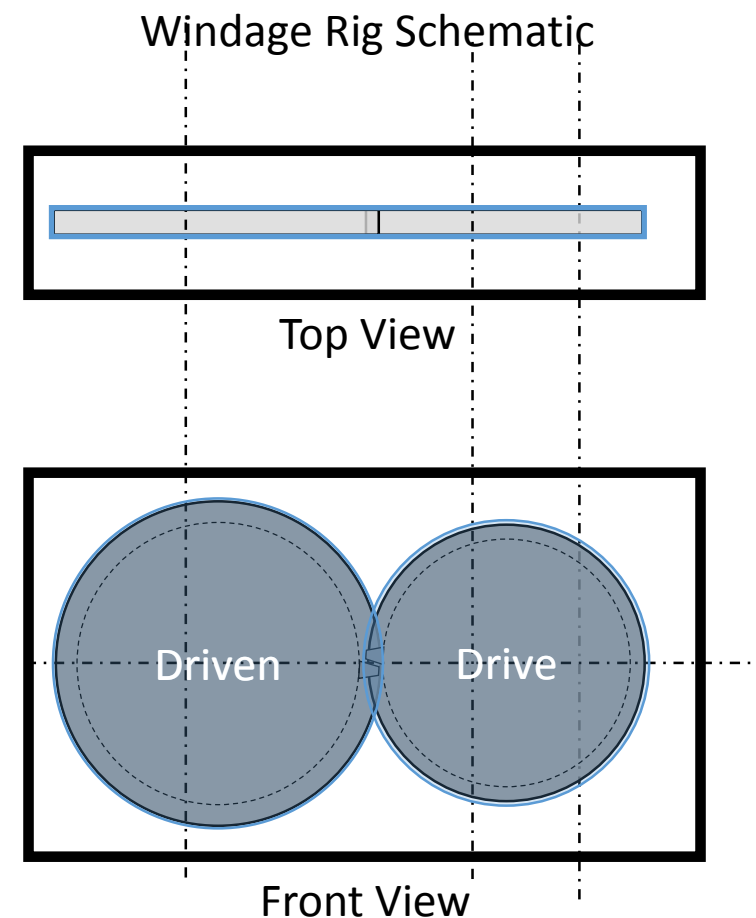
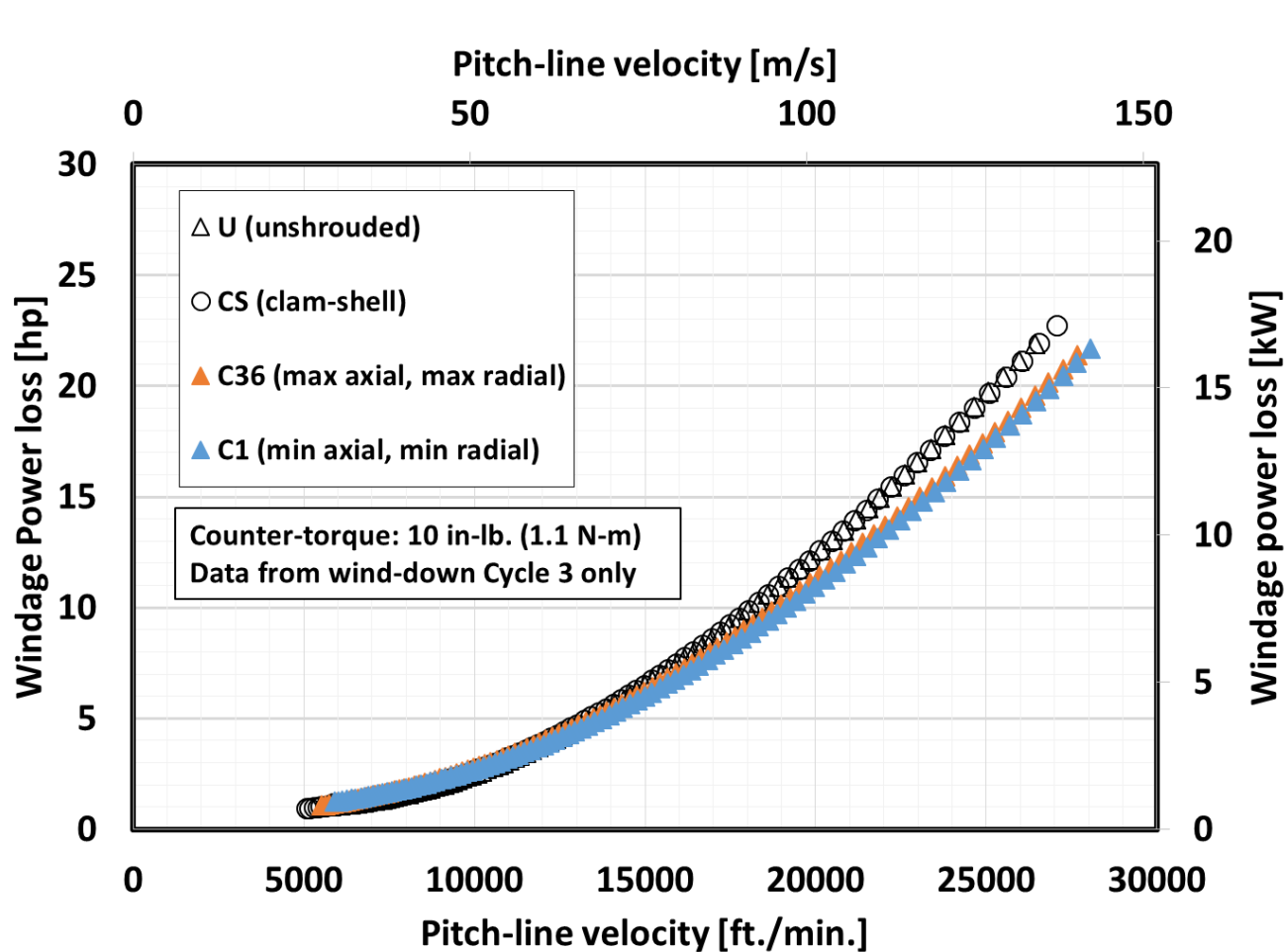

# WPL versus Shroud Configuration

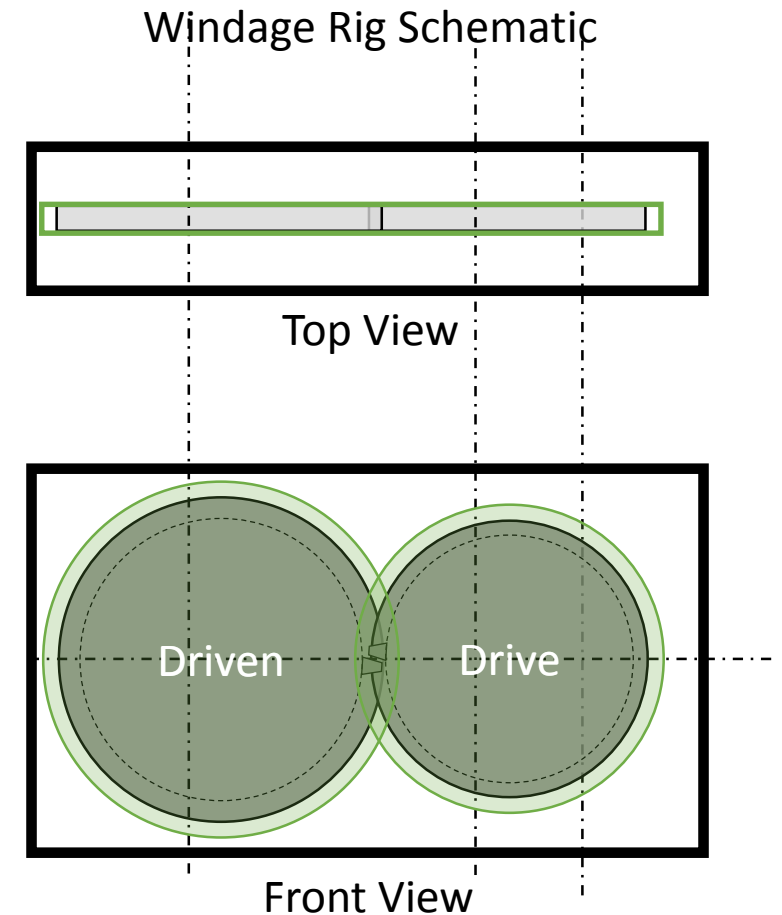
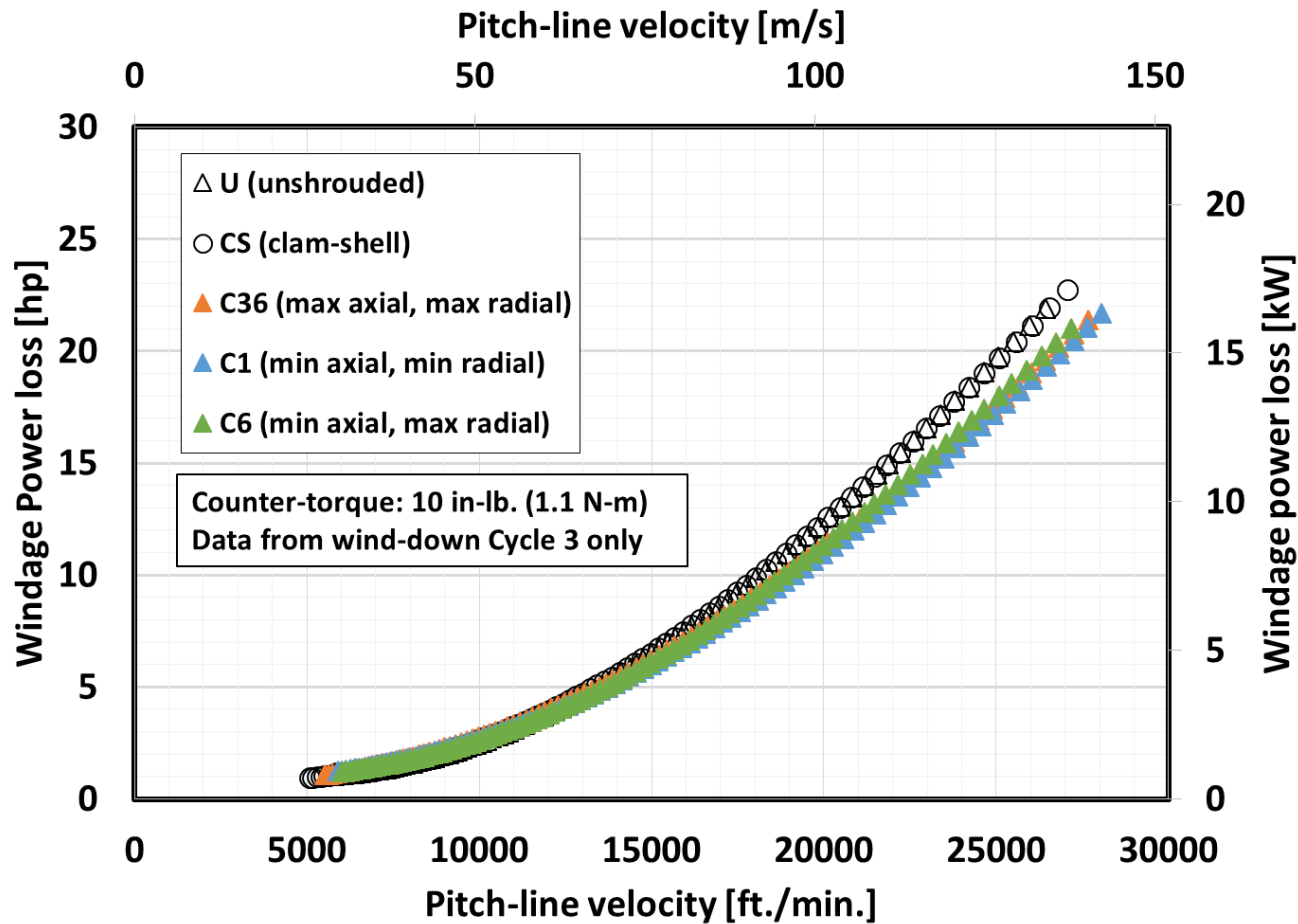

# WPL versus Shroud Configuration

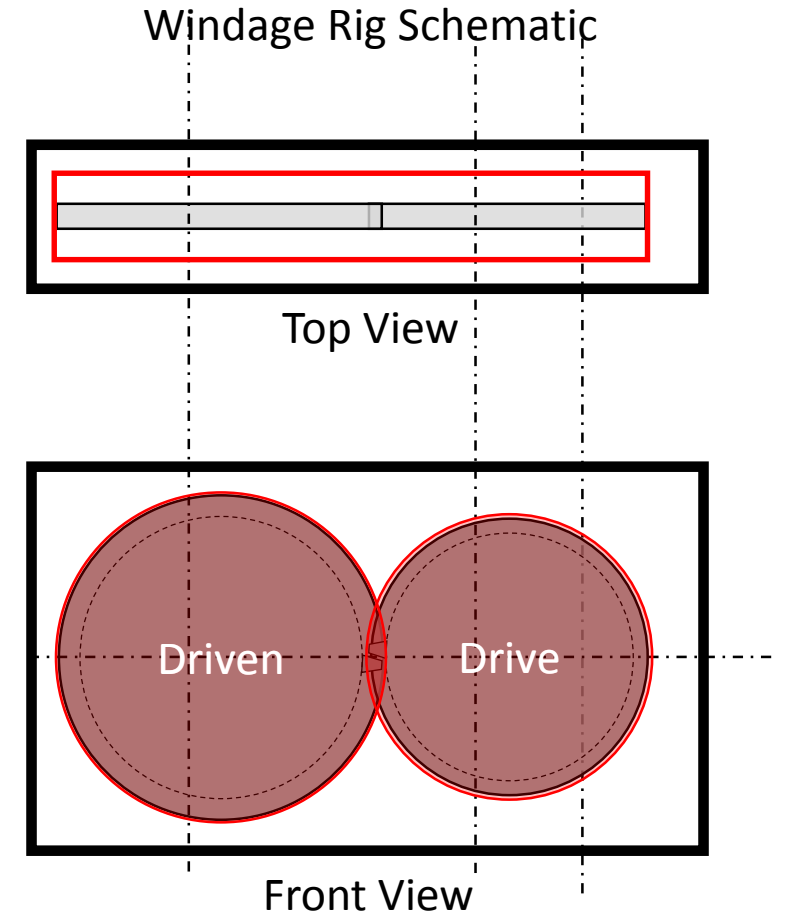
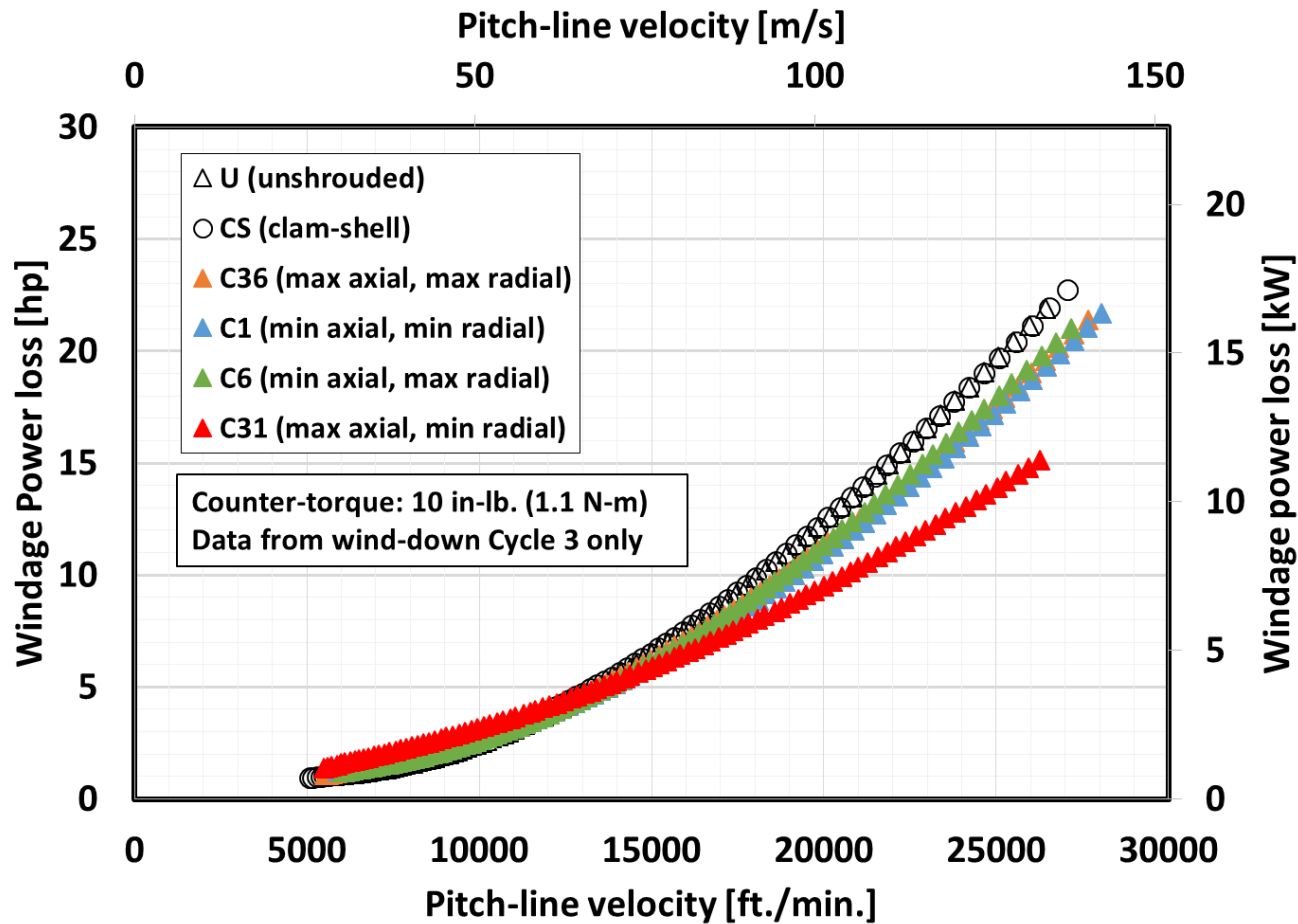

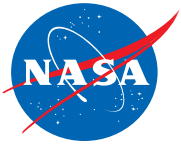

# WPL Repeatability: C31 configuration

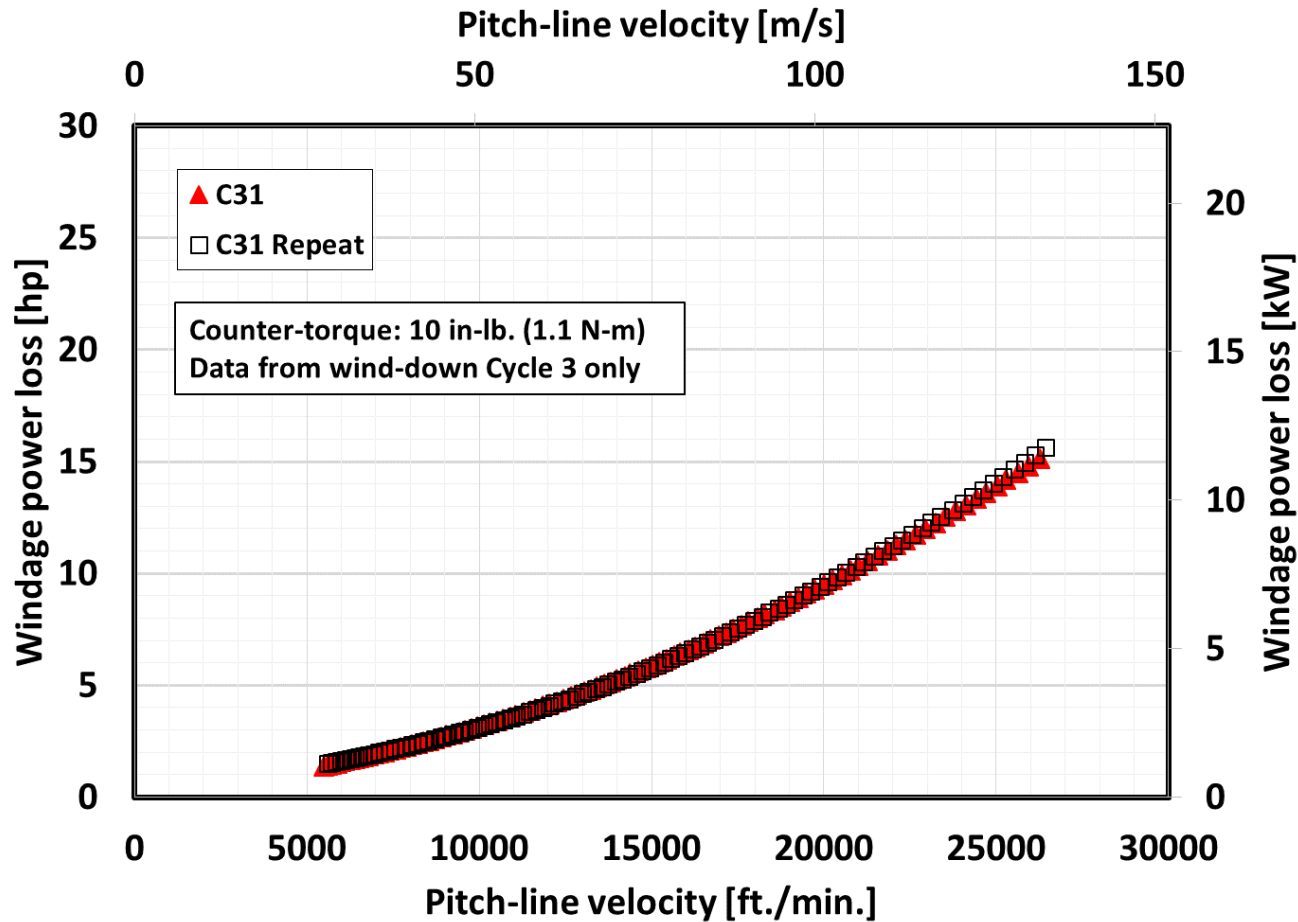

	C31	C31 Repeat
Avg. Oil Inlet Temp. [°F]	101	102
Avg. Oil Inlet Flow [gpm]	1.07	1.10



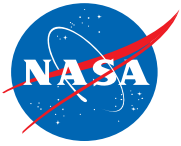

# Conclusions & Further Work

- Conclusions
  - Shrouding effectiveness negligible on WPL below 15,000 ft./min.
  - 10% decrease in WPL with small axial, small radial clearance shrouds
  - 29% decrease in WPL for large axial, small radial clearance shrouds
- Further Work
  - Plans to test a modified shroud configuration
  - Plans to determine location of maximum pressure near the mesh point
  - Other
    - In-to-mesh vs out-of-mesh oil flow
    - Oil jet size, position
    - Oil drain hole geometry, position

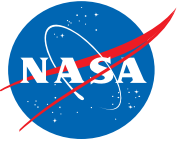

# Acknowledgements

- NASA Revolutionary Vertical Lift Technology (RVLT) Project
- Dr. Robert F. Handschuh
- Sig Lauge
  - HX5 Sierra, Technical Test Support

# Appendix

# Helicopter Performance Chart

- Ref: FAA Helicopter Flying Handbook, Chapter 7.
- Torque required for cruise or level flight, Figure 7.3

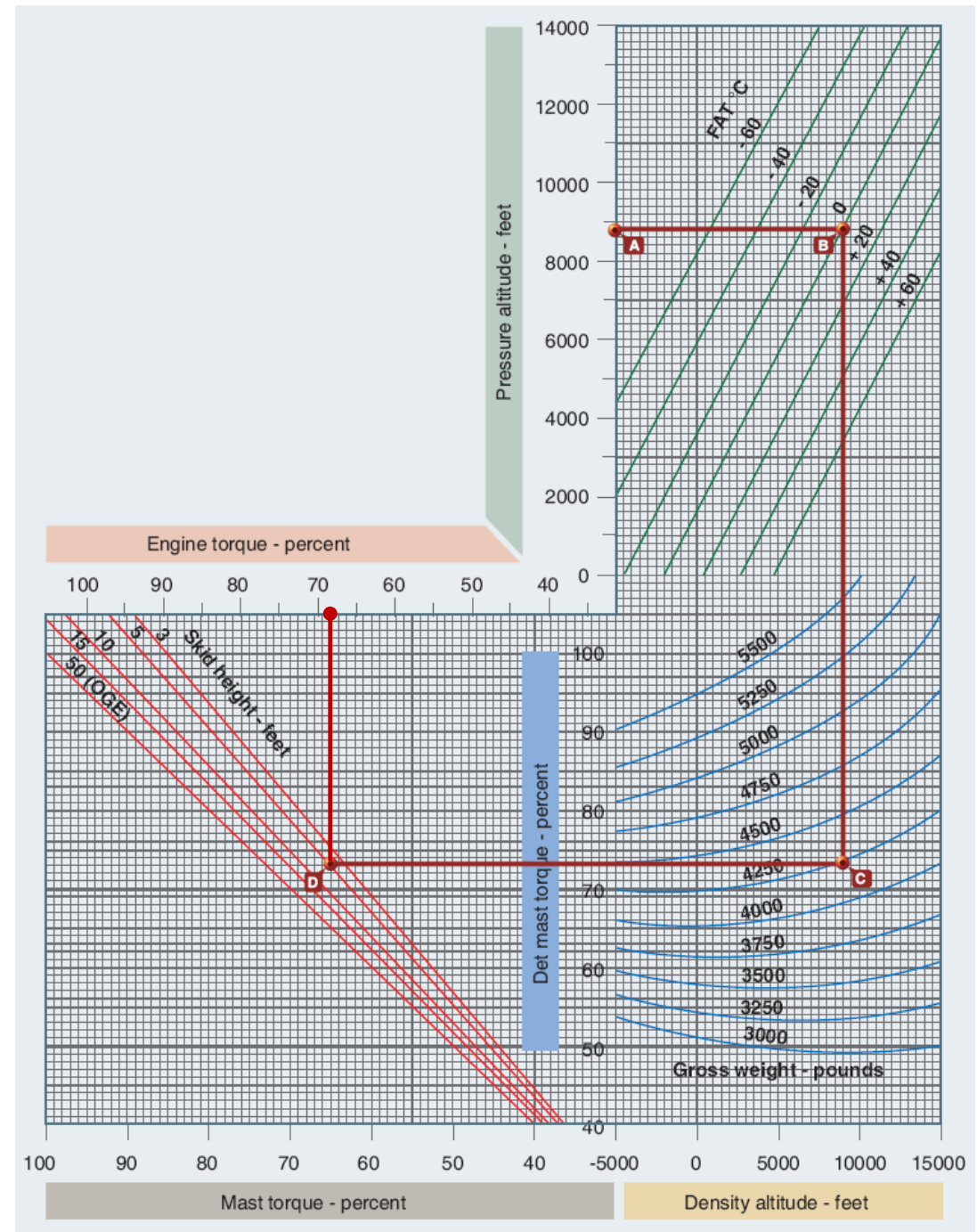

# Helicopter Performance Chart

- Ref: FAA Helicopter Flying Handbook, Chapter 7.
- Torque required for cruise or level flight, Figure 7.3

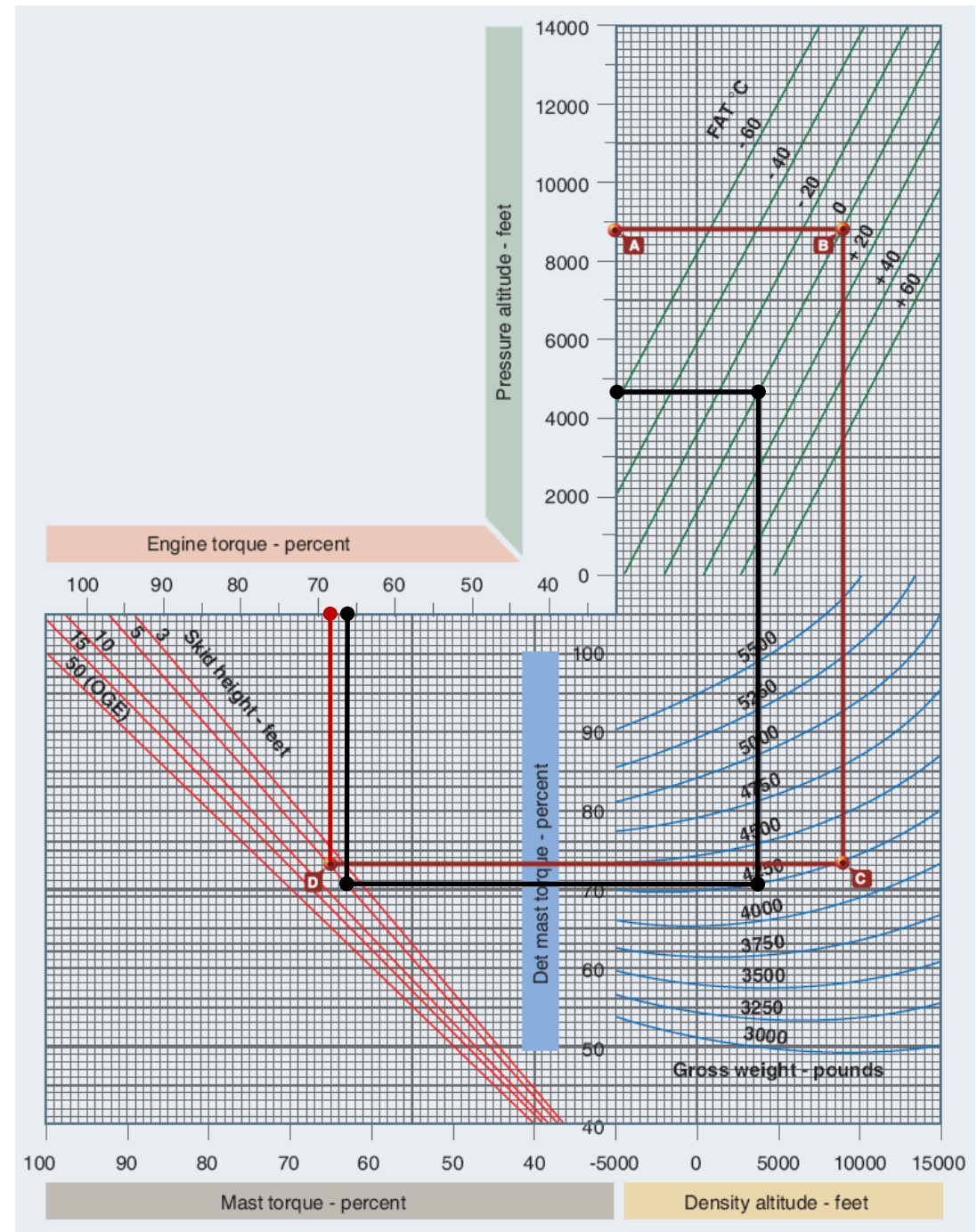

# Helicopter Performance Chart

- Ref: FAA Helicopter Flying Handbook, Chapter 7.
- Torque required for cruise or level flight, Figure 7.3

