



# Single-Event Effect Testing of the Linear Technology LTC6103HMS8#PBF Current Sense Amplifier

Ka-Yen Yau<sup>1</sup>, Michael Campola<sup>2</sup>, and Edward Wilcox<sup>1</sup>

1: ASRC Federal Space & Defense, Lanham, MD 20706

2: NASA Goddard Space Flight Center, Greenbelt, MD 20771

Test Date: August 11, 2016

Report Date: August 18, 2016

## 1. Purpose

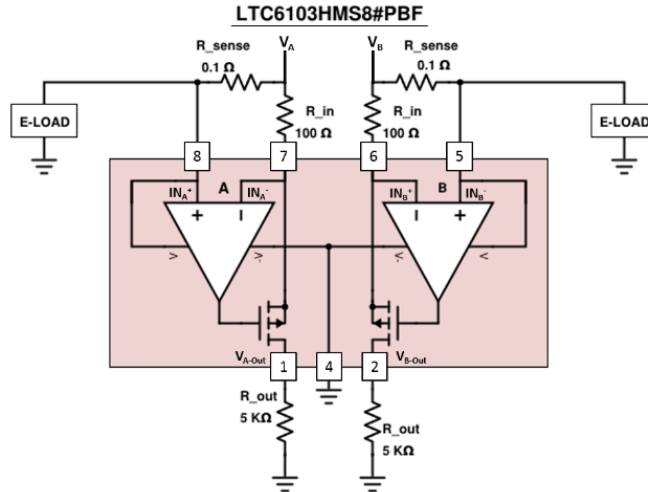
The LTC6103HMS8#PBF<sup>1</sup> current sense amplifier from Linear Technology was tested for both destructive and non-destructive single-event effects (SEE) using the heavy-ion cyclotron accelerator beam at Lawrence Berkeley National Laboratory (LBNL) Berkeley Accelerator Effects (BASE) facility. During testing, the input voltages and output currents were monitored to detect single event latch-up (SEL) and single-event transients (SETs).

## 2. Test Samples

The LTC6103 is a commercial, automotive-grade, dual high-voltage, high-side current sense amplifier developed by Linear Technology. The device is two independent amplifiers (sharing only the same  $V^-$  terminal) in an 8-lead plastic Mini Small Outline Package (MSOP). The LTC6103 operates on supplies from 4 V to 60 V, converting the input voltage to output current.

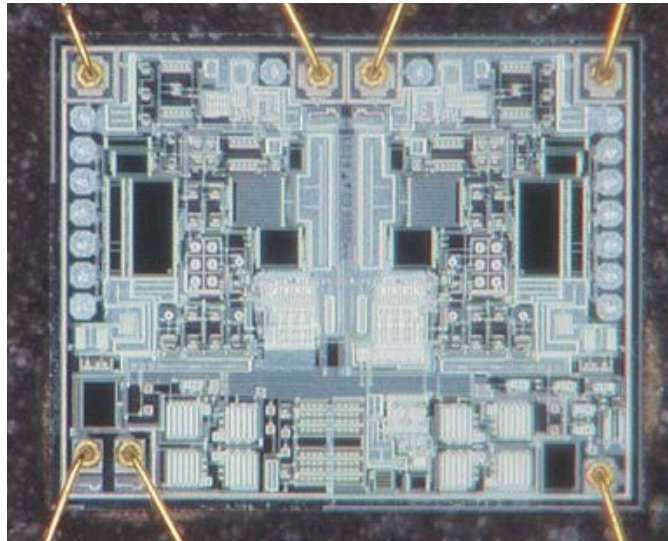
---

<sup>1</sup> Henceforth abbreviated as LTC6103.



**Figure 1: Diagram of typical circuitry of the two 16-bit current sense channels. Resistor values showing those to be used in this test.**

Three samples of the LTC6103 were tested (see Fig. 1). Prior to testing, the pieces were acid-etched to remove the plastic packaging and surface mounted on copper printed circuit boards (see Fig. 2). The package material had to be removed since the range of the accelerated heavy ions is not sufficient to penetrate the package and the back-end-of-line process materials above the sensitive volumes.



**Figure 2: Image of the acid-etched LTC6103 die.**

### 3. Test Facility

**Facility:** Lawrence Berkeley National Laboratory (LBNL) Berkeley Accelerator Space Effects (BASE) Facility 88" Cyclotron

**Cocktail:** 10 MeV/amu cocktail, under vacuum

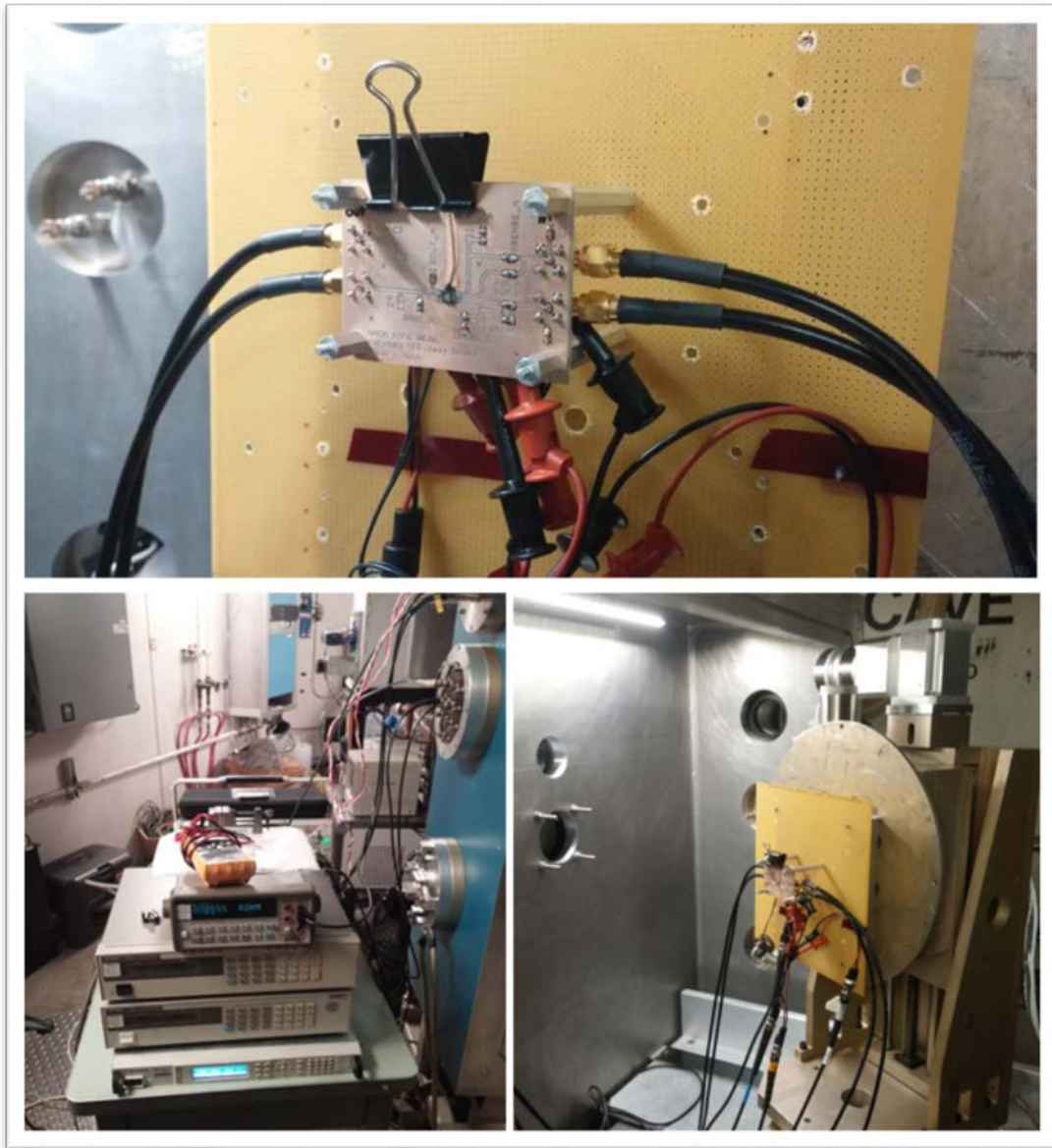
- Flux:**  $1 \times 10^4$  ion/cm<sup>2</sup>/s
- Fluence:**  $3 \times 10^6$  ions/cm<sup>2</sup> or until single event latch-up occurs
- Ion species:** Table 1 shows the incident beam properties of ions intended for use.

**Table 1:**  
Heavy-ion specie with respective linear energy transfer (LET) value, range, and energy.

Ion	LET in Si (MeV·cm <sup>2</sup> /mg)	Range in Si (μm)	Energy (MeV)
Ne	3.5	175	216
Ar	9.7	130	400
Cu	21	108	659
Kr	31	110	886
Ag	48	90	1040
Au	86	105	1960

#### 4. Test Conditions

- Beam time required:** 8 hours
- Test Temperature:** Ambient temperature (~25°C) and 55°C-60°C
- Power Supply Voltage:**  $V_A$ /  $V_B$ : Input voltages to amplifiers A and B, 4 to 60V in 14V increments; voltage source of  $V^+$ ,  $IN_{A/B}^+$ , and  $IN_{A/B}^-$   
 $V^-$ : 0V



**Figure 3: Test setup shown in beamline before vacuum tank closed and pumped.**

## **5. Test Method**

The test circuit is pictured above in Fig. 1.  $V_A$  and  $V_B$  were each supplied by an Agilent Technology N6702A 1200W supply. This multiport voltage source supplied DC signal to power and bias the device.

An Agilent 300W System DC electronic load (e-load) was attached to amplifier A and amplifier B. The e-load draws current through the sense resistor, resulting in a larger voltage difference between  $IN_{A/B}^+$  and  $IN_{A/B}^-$ . Irradiations were conducted with the e-load being set to draw either 0.5 A or 1.6 A.

A resistive heating pad was attached to the test board to raise the temperature of the device under test (DUT). The temperature of the DUT was monitored with a thermistor. Tests were conducted at both ambient and elevated (55°C-60°C) temperatures. Several exposures were conducted at 70°C.

The voltage across the 5 kΩ output resistor for each amplifier was monitored in-situ with a Tektronix MSO5204 digital oscilloscope to capture voltage transients and save them files.  $V_{out}$  and  $I_{out}$  were monitored to detect and characterize SEL. All equipment was connected to a power conditioner.

Testing was conducted in vacuum at LBNL. The DUTs were centered in the beam, and ion exposures conducted at normal incidence and at 30°, 45°, and 60° tilt to the DUT surface normal. The testing started with low LET ions (e.g., Ne and Ar). The frequency of resulting SEE determined the following ions to be used. The fluence for each shot was high enough to maintain reasonable statistics. The flux was controlled to avoid multiple, simultaneous ion strikes.

Beam dosimetry information was recorded for each run, including the beam energy, ion species, ion energy, ion range in silicon, LET, fluence, flux, and exposure time. Total ionizing dose (TID) from the heavy ion irradiation can be calculated after the fact and will not impart significant effective dose due to high levels of recombination within the ion track.

#### *Irradiation Method: Single-Event Latch-Up (SEL)*

For SEL evaluation, each DUT was irradiated to a fluence not exceeding  $3 \times 10^6 \text{ cm}^{-2}$  at room temperature. The input current and output voltages were monitored *in-situ* during the irradiation. A rapid increase in the supply current could potentially signal the onset of SEL. In the event of a SEL, the procedures are as follows.

- Shut off the beam immediately, and record the fluence.
- If the current is in a stable state, allow the DUT to dwell in the latched condition for at least 5 minutes.
- Attempt to recover operation by first lowering supply voltage in 5 V increments. If SEL persists, power cycle.
- After the device recovers functionality, the operator should perform a basic parametric characterization to check for degradation.
  - To ensure part functionality, the output voltages of both amplifiers A and B will be measured with  $V_A$  and  $V_B$  held at either 4 or 60 V for both e-load values. If the voltage gain is maintained near or at expected level for all voltage conditions, the part is still properly functioning.
- If the part shows no degradation, then irradiation can continue. Else, radiation testing on the DUT will be stopped and the part will be replaced.
- Determine the SEL LET threshold, and map out a cross section response curve.

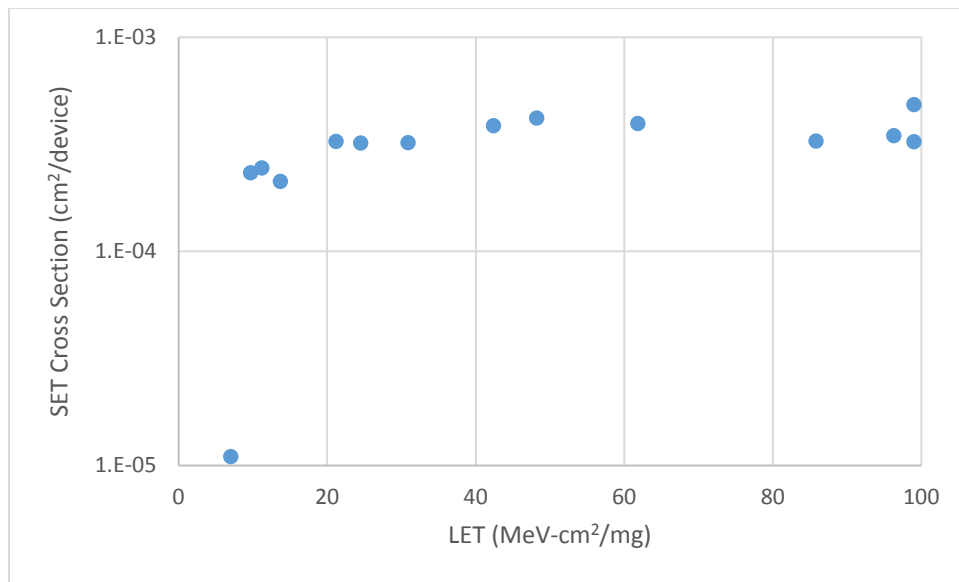
## **6. Test Goals**

- Determine the SEL susceptibility at room temperature (and if time permits, at elevated temperatures)
  - Determine SEL LET threshold for various voltage inputs.
  - Determine characteristics of SEL, including whether the latch-up is immediately destructive or stable in a latched state.
- Determine the SET susceptibility at room temperature (and if time permits, at elevated temperatures)
  - Determine SET LET threshold for various voltage inputs.
  - Characterize dominant class of SET waveform of LTC6103.
  - Map out SET cross section.

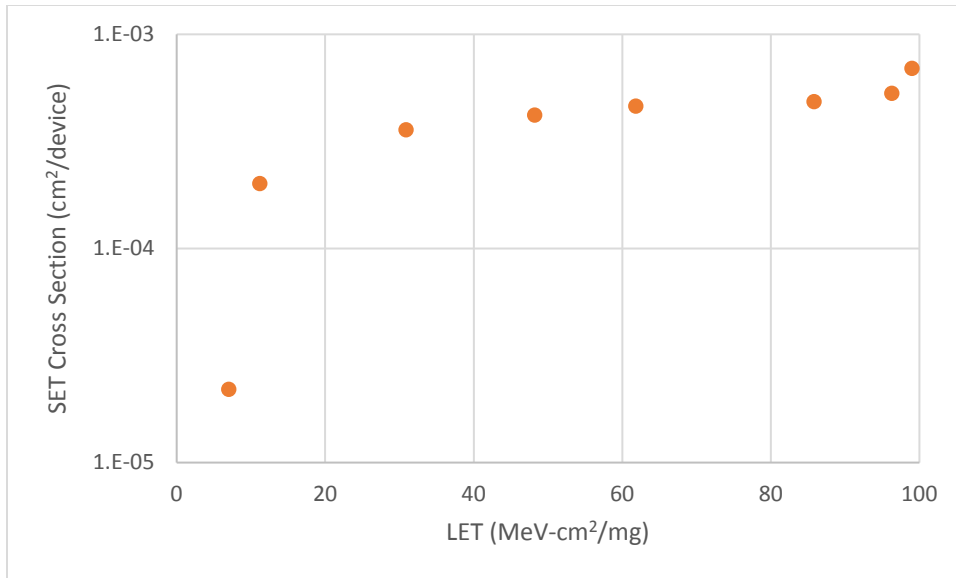
## 7. Test Results

First and foremost, no SEL was observed while testing this part. This included irradiations with Au ions at elevated temperatures approaching 70°C and cumulative fluences of  $9 \times 10^6 \text{ cm}^{-2}$  across two devices at tilt angles up to 60°. While complete one-octant screening (both 0° and 90° roll angles at all tilt angles) could not be completed, this testing gives some confidence that the SEL cross section is very low if it is even measurable at all using practical ion-angle-fluence combinations.

SETs were observed during testing with all ions, at all angles, and at all temperatures. With  $V_A$   $V_B$  set at 60 V, the SET cross sections for 0.5 A and 1.6 A load currents are shown in Figures 3 and 4 below. This is assumed to cover worst-case conditions. In both plots there is a rapid increase in cross section above a LET of 5 MeV-cm<sup>2</sup>/mg. More time spent gathering data at low LET would help fill in this part of the data set, but since the focus was on looking for destructive events time prevented additional investigation.

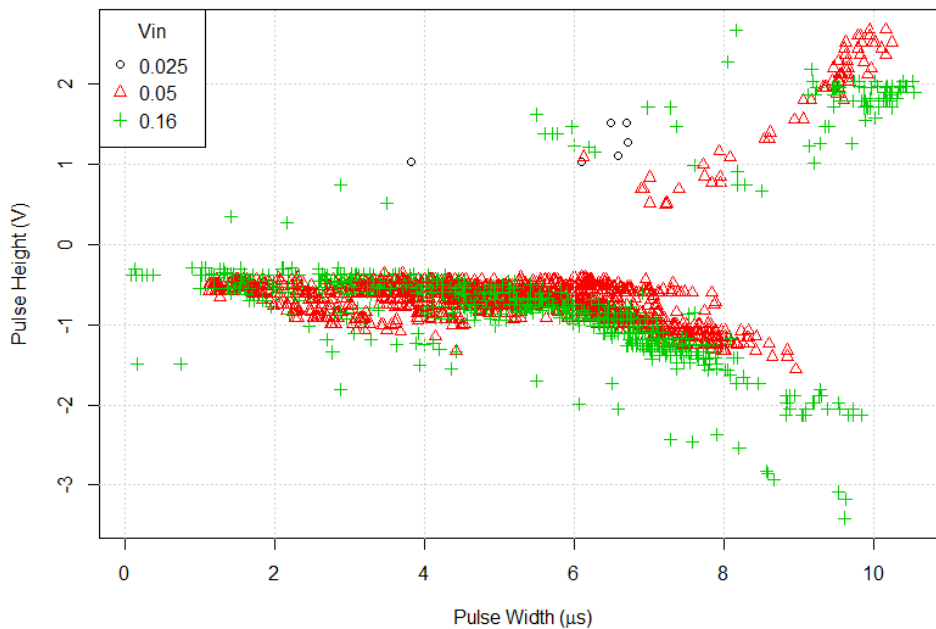


**Figure 4: 0.5 A load current SET cross section with 60 V input.**

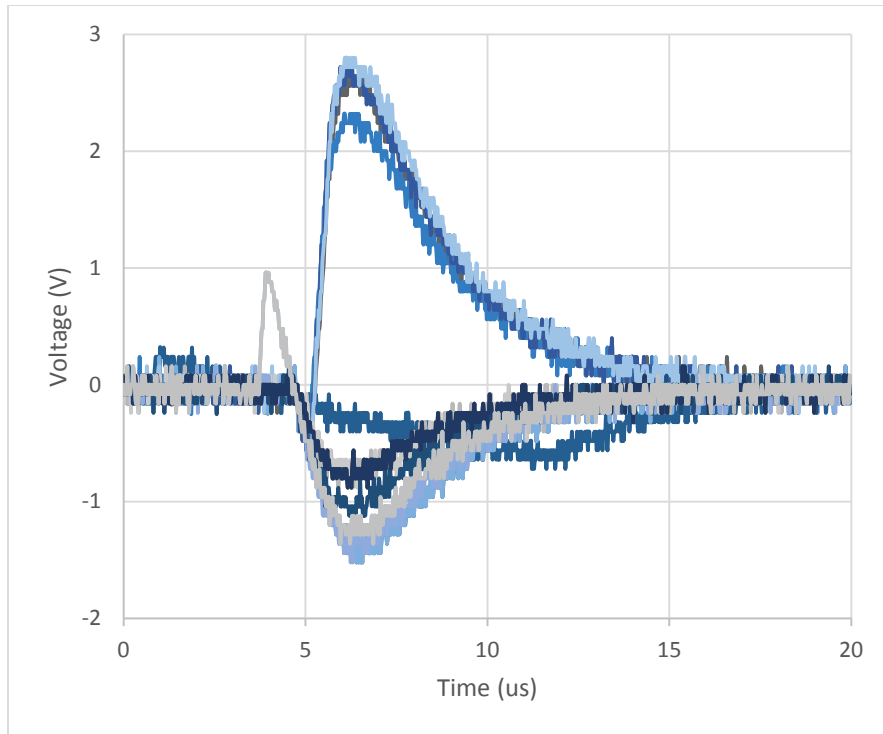


**Figure 5: 1.6 A load current SET cross section with 60 V input.**

The pulse width vs. pulse height for every run is shown in Figure 6. There was no dependence on LET to the size of the transients, which signifies that there are multiple sensitive nodes within the device that result in positive or negative going transients. The transients have been grouped by the differential input voltage across the sense resistor, corresponding to the varied loads that were tested. Figure 7 and Figure 8 show the two cases of larger transients, the smaller ones follow these shapes with less pronunciation.



**Figure 6: Pulse Width and Height for the transients recorded.**



**Figure 7: Varied transient response for one run 0.5A load, Au beam.**

## 8. Reference

- [1] Linear Technology (2016), “*LTC6103: Dual High Voltage, High Side Current Sense Amplifier*” [Online]. Available: <http://cds.linear.com/docs/en/datasheet/6103f.pdf>. Accessed on: August 2, 2016.

## Appendix A

Example test flow.



LTC6103HMS8#PBF Berkeley Test Flow

