

Jig-Shape Optimization of a Low-Boom Supersonic Aircraft

Prepared For:
AIAA SciTech 2018

AIAA/ASCE/AHS/ASC Structures, Structural Dynamics, and Materials Conference
January 8-12, Kissimmee, Florida



Prepared By:
Chan-gi Pak, Ph.D.

Structural Dynamics Group, Aerostructures Branch (Code RS)
NASA Armstrong Flight Research Center



Overview

- Theoretical background (slides 3-10)**
- Computational validation (slides 11-28)**
- Conclusions (slide 29)**

Theoretical background





Introduction

Supersonic Commercial Transport Aircraft Design

❖ Safety

- Light weight airframe can cause strength, buckling, aeroelastic, and aeroservoelastic issues.

❖ Sonic boom

- Supersonic flight of “commercial transport” aircraft allowed only over the ocean.
- Perceived Loudness in decibels

- ✓ **NASA’s N+2 goal: 75 PLdB**
- ✓ Concorde: **104 PLdB**
- ✓ High Speed Civil Transport (HSCT): **99 PLdB**

❖ Fuel efficiency

- Light weight airframe
- Reduced drag

Developing Low Boom Flight Demonstrator (LBFD)

- ❖ Lockheed Martin Skunk Works was the prime contractor for preliminary design of X-plane.

❖ Loudness: 74 PLdB

Major Issue

- ❖ Outer-mold-line configuration of an aircraft is design for the desired aerodynamic performance. Assume rigid structure.
- ❖ Flexibility of the structure changes the aerodynamic performance.
- ❖ It has been reported that one degree of the tip twist of a supersonic wing and stabilator under the cruise flight condition can increase the sonic boom level by 0.2 PLdB and 1.3 PLdB, respectively.

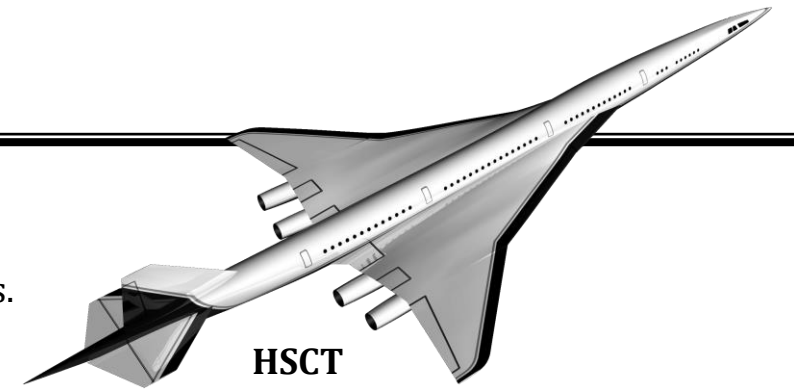

HSCT



Concorde



Low boom supersonic aircraft

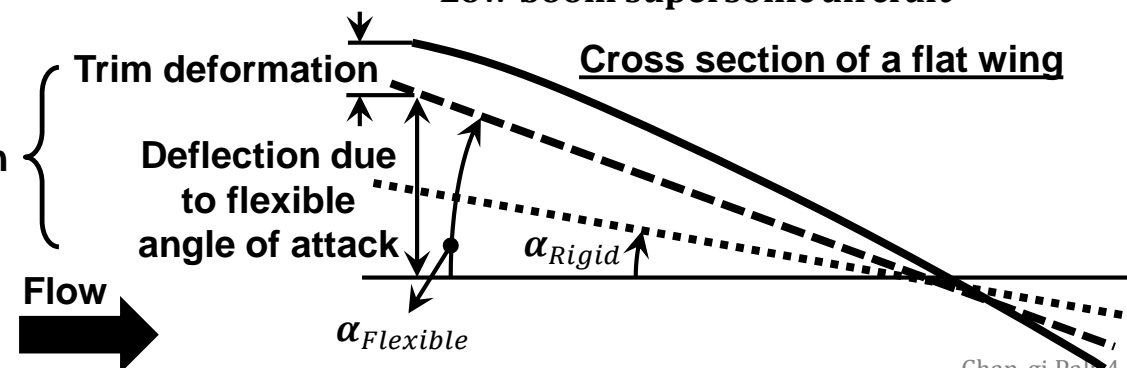



Jig-Shape Optimization Problem Statement

□ Assume unconstrained Optimization

□ Optimization Problem Statement

❖ Find design variables: $\{X\} = [X_1, X_2, \dots, X_{ndv}]^T$ which

$$\text{minimize } \left\{ F(X) = \sum_{j=1}^{nsurf \times 3} \Delta T_j^2 \right\}$$

❖ $\{\Delta T\} \equiv \{T\}_t - \{T\}_d$

❖ $\{T\}_t$ = target trim shape at surface GRIDs

➤ Sonic boom level is computed based on target trim shape.

❖ $\{T\}_d$ = trim shape based on design jig shape

➤ $\{jig\}_d \xrightarrow{\text{trim analysis}} \{T\}_d$

➤ $\{jig\}_d \equiv \{jig\}_b + \{\Delta jig\}$

✓ $\{jig\}_d$ = design jig-shape

✓ $\{jig\}_b$ = baseline jig-shape

✓ $\{\Delta jig\}$ = jig-shape changes

➤ $\{\Delta jig\} = [\Phi]\{X\}$

✓ X_i = i-th design variable

✓ $[\Phi] = [\{\phi\}_1 \{\phi\}_2 \dots \{\phi\}_{ndv}]$

• $\{\phi\}_i$ = i-th basis function

■ Eigen vector based on jig shape

■ Eigen vectors are normalized as Max deflection = 1 inch.



Update Jig-Shape Module: using shape_change.exe

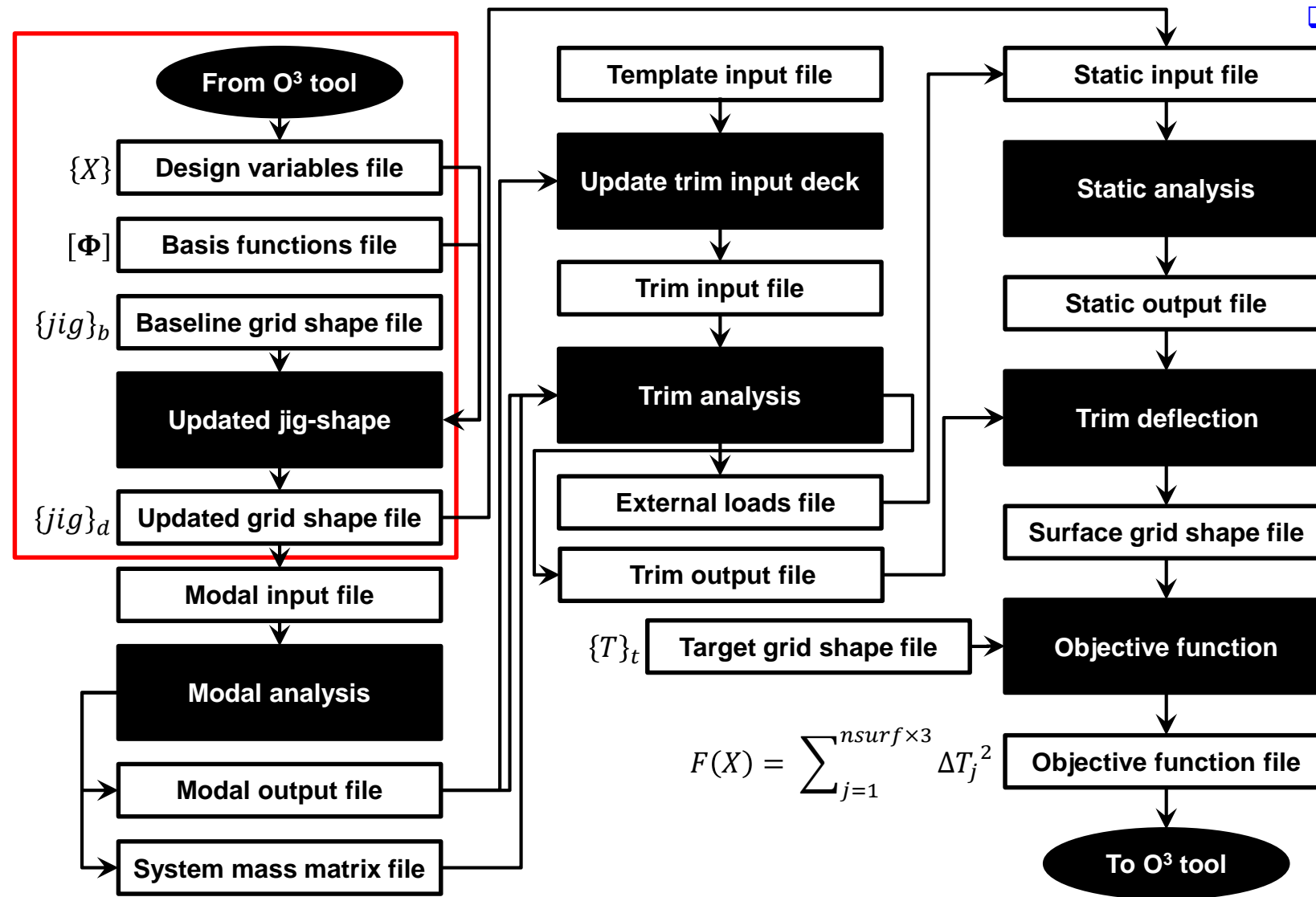

- ❑ **Shape_change.exe:** Change jig shape using design variables and basis functions.
- ❖ $\{jig\}_d \equiv \{jig\}_b + [\Phi]\{X\}$
 - ❖ Input
 - Design variables file $\{X\}$: basis functions for the shape optimization (basis_functions.dat)
 - Basis functions file $[\Phi]$: design variables of the current optimization step (design_var)
 - Baseline grid shape file $\{jig\}_b$: grid information of the baseline configuration (grid_base.bdf; a template file)
 - ❖ Output
 - Updated grid shape file $\{jig\}_d$: grid information of the updated configuration (grid_update.bdf)

$$F(X) = \sum_{j=1}^{nsurf \times 3} \Delta T_j^2$$

Change jig shape using design variables & basis functions.



Modal Analysis Module: using MSC/NASTRAN solution 103

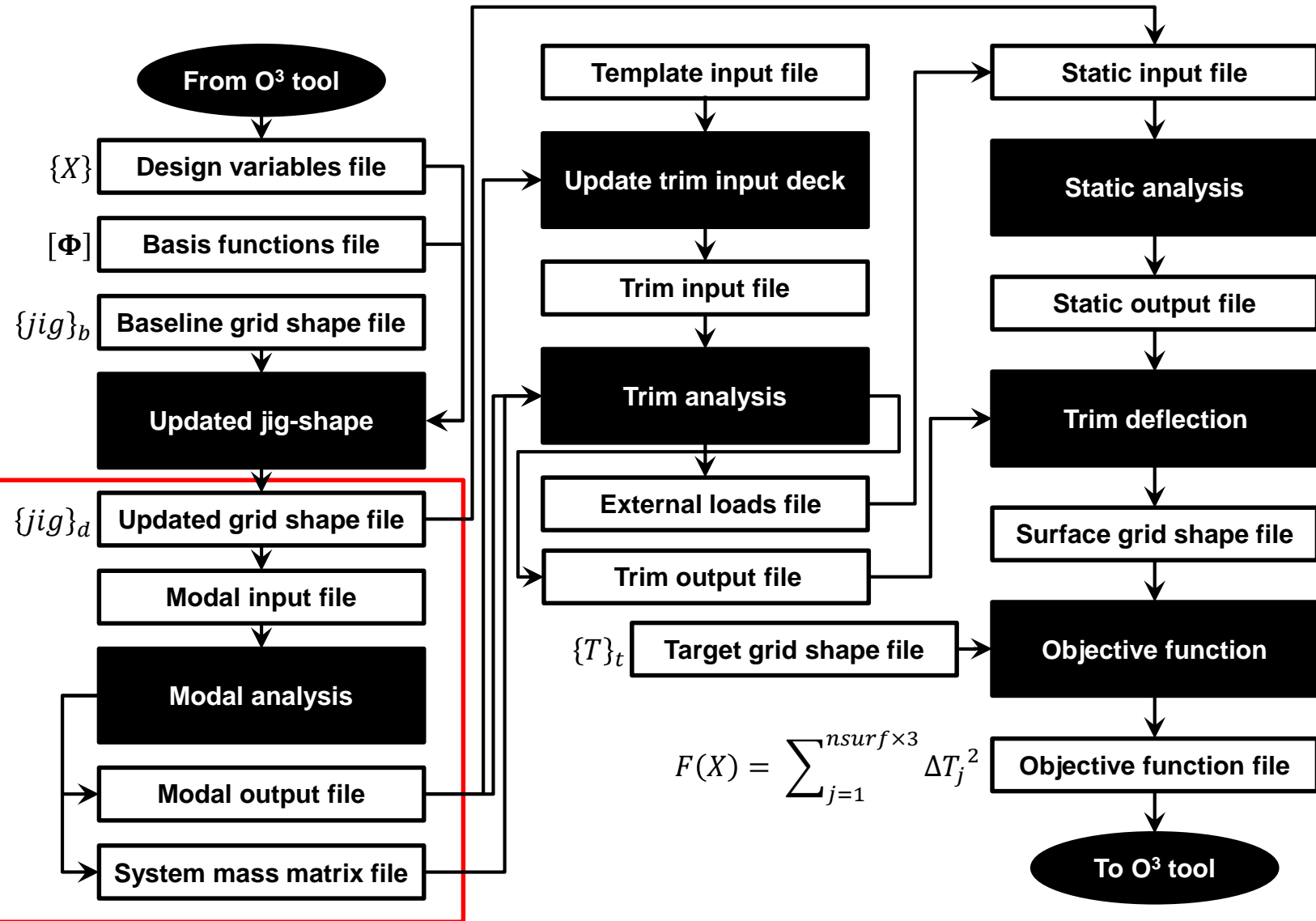

- ❑ Perform modal analysis using **MSC/NASTRAN solution 103** to change system mass matrix file (MGH matrix), weight, moment of inertia, and CG location for trim analysis.
- ❑ Compute six rigid body modes.

$$F(X) = \sum_{j=1}^{nsurf \times 3} \Delta T_j^2$$

Change mode shapes, weight, moment of inertia, & CG location for trim analysis.



Trim Analysis Module: using ZAERO & change_trim.exe

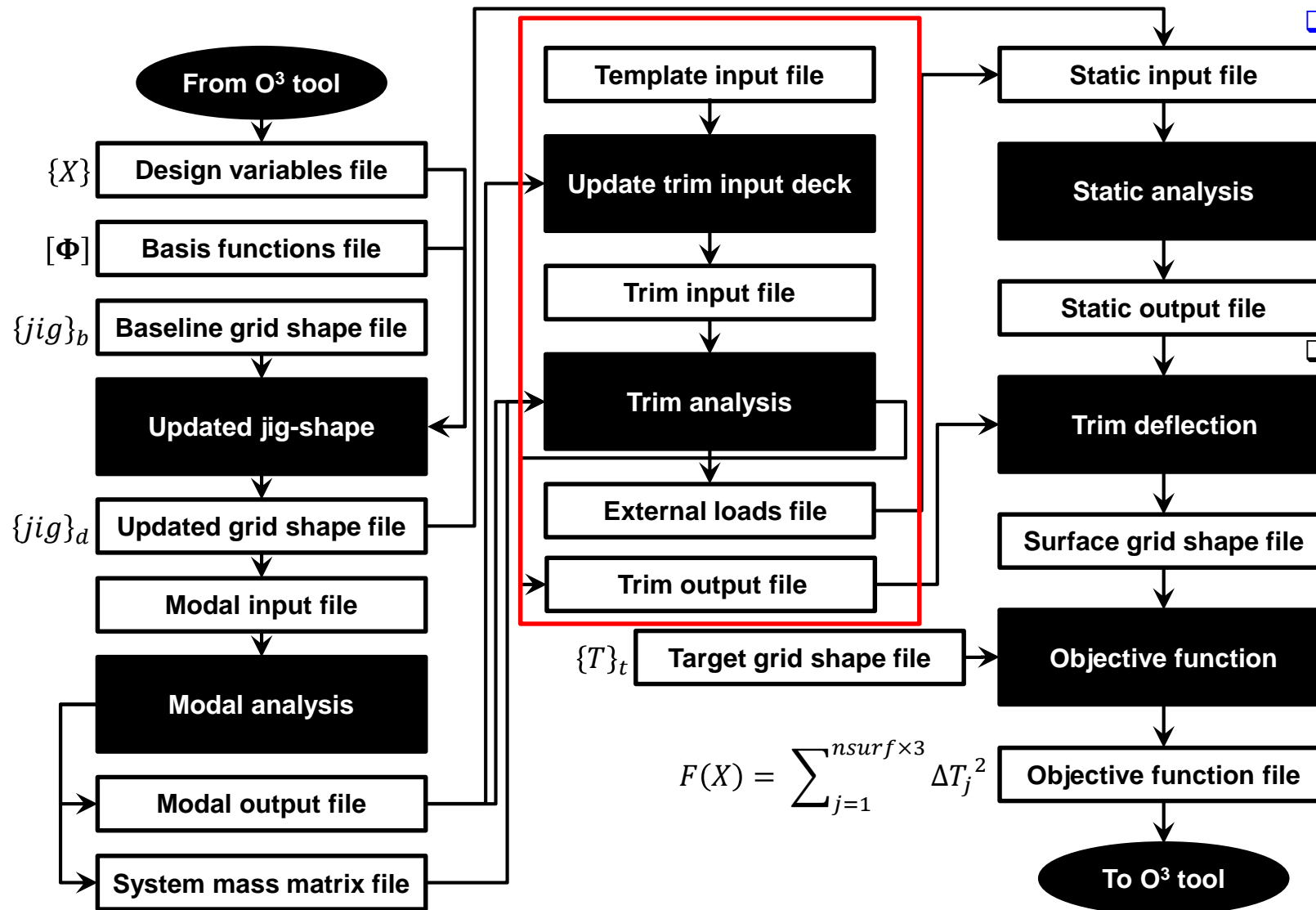

$$F(X) = \sum_{j=1}^{nsurf \times 3} \Delta T_j^2$$

❑ **Change_trim.exe:** Update input deck for ZAERO trim analysis.

- ❖ Input
 - Template input file: file for ZAERO based trim analysis (Lbfd_trim.bdf)
 - Modal output file: f06 file from MSC/NASTRAN
 - ❖ Output
 - Trim input file: updated ZAERO input file to be used for trim analysis (trim.bdf)
- Perform trim analysis using **ZAERO**
- ❖ Input
 - Trim input file: Trim.bdf
 - ❖ Output
 - External loads file: aerodynamic load + inertial load (Extload.dat)
 - Trim output file: ZAERO output (trim results)

Compute external load using ZAERO code.



Objective Function Module: using MSC/NASTRAN solution 101, shape.exe, & differ.exe

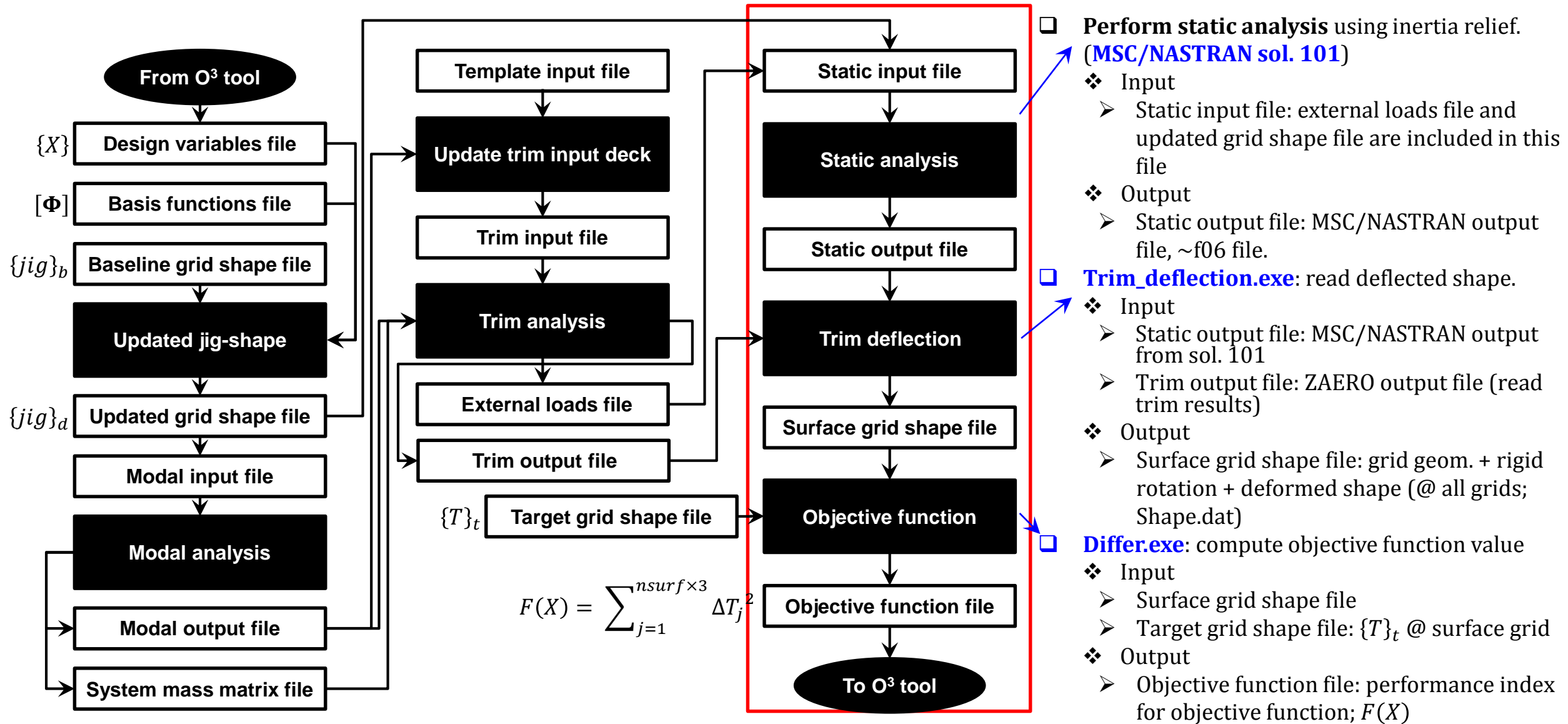

Compute trim deformation using MSC/NASTRAN solution 101 using inertia relief.



Compute Starting Design Variables: Using Least Squares Surface Fitting Technique

- $\{\Delta T\}_t \equiv \{T\}_t - \{T\}_b$
 - ❖ $\{T\}_t =$ target trim shape at surface GRIDs
 - ❖ $\{T\}_b =$ trim shape based on the baseline jig-shape
 - $\{jig\}_b \xrightarrow{\text{trim analysis}} \{T\}_b$
- Fitting $\{\Delta T\}_t$ surface using perturbed shapes $\{\Delta T\}_i, i = 1, 2, \dots, ndv$
 - ❖ Perturb baseline jig-shape using basis functions $[\Phi]$
 - $\{jig\}_d \equiv \{jig\}_b + [\Phi]\{X\}$
 - Where, $\{\phi\}_i =$ i-th basis function
 - $\{jig\}_b + \{\phi\}_i \xrightarrow{\text{trim analysis}} \{T\}_i$
 - $\{\Delta T\}_i \equiv \{T\}_i - \{T\}_b$ (i-th perturbed shape)
 - ❖ Define a matrix: $[\Psi] = [\{\Delta T\}_1 \{\Delta T\}_2 \dots \{\Delta T\}_{ndv}]$
- $[\Psi]\{X\} = \{\Delta T\}_t$
 - ❖ $[\Psi]^T[\Psi]\{X\} = [\Psi]^T\{\Delta T\}_t$
 - ❖ $([\Psi]^T[\Psi])^{-1}[\Psi]^T[\Psi]\{X\} = ([\Psi]^T[\Psi])^{-1}[\Psi]^T\{\Delta T\}_t$
- Starting design variables: $\{X\} = ([\Psi]^T[\Psi])^{-1}[\Psi]^T\{\Delta T\}_t$

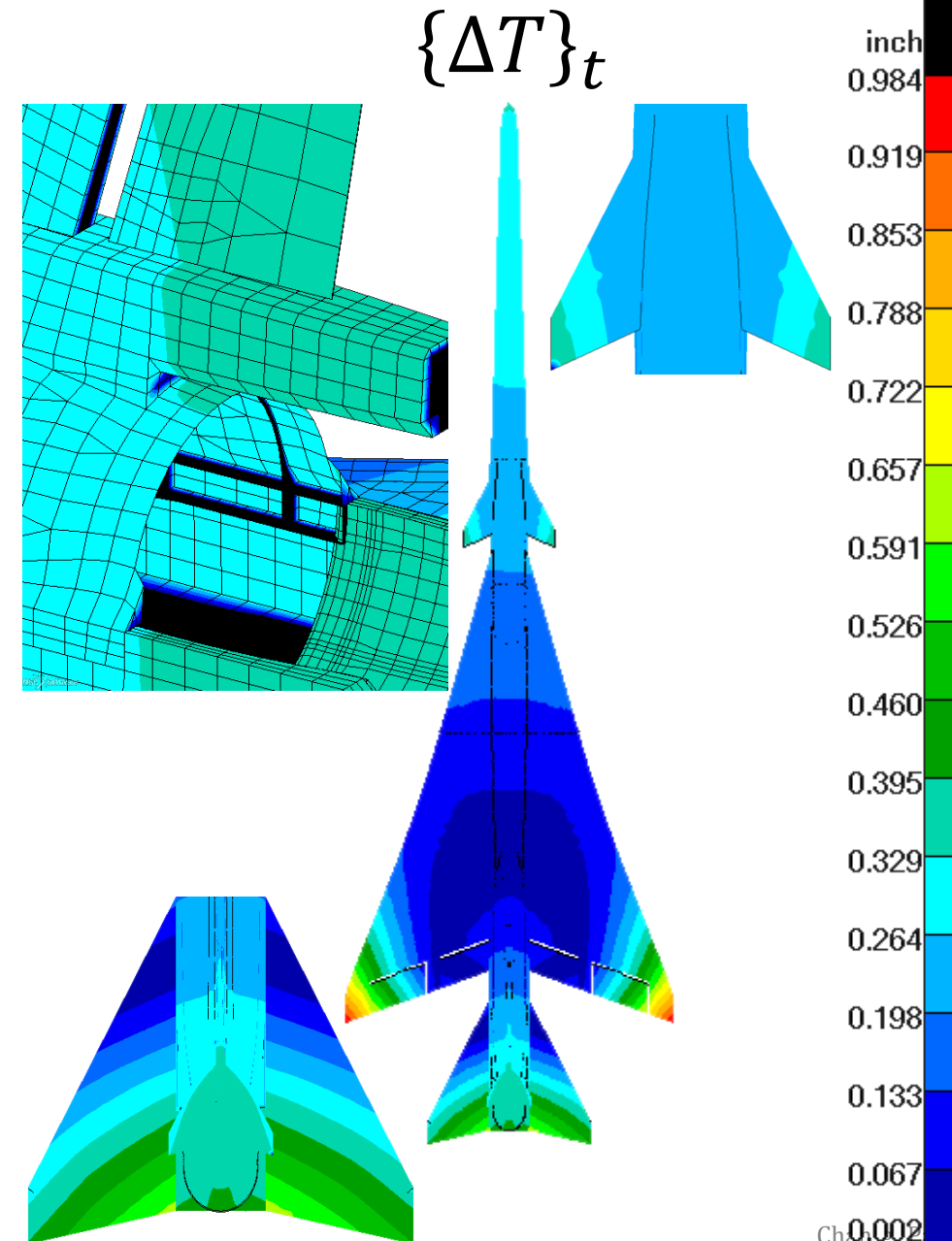

Computational validation





Structural Finite Element Model and Aerodynamic Model

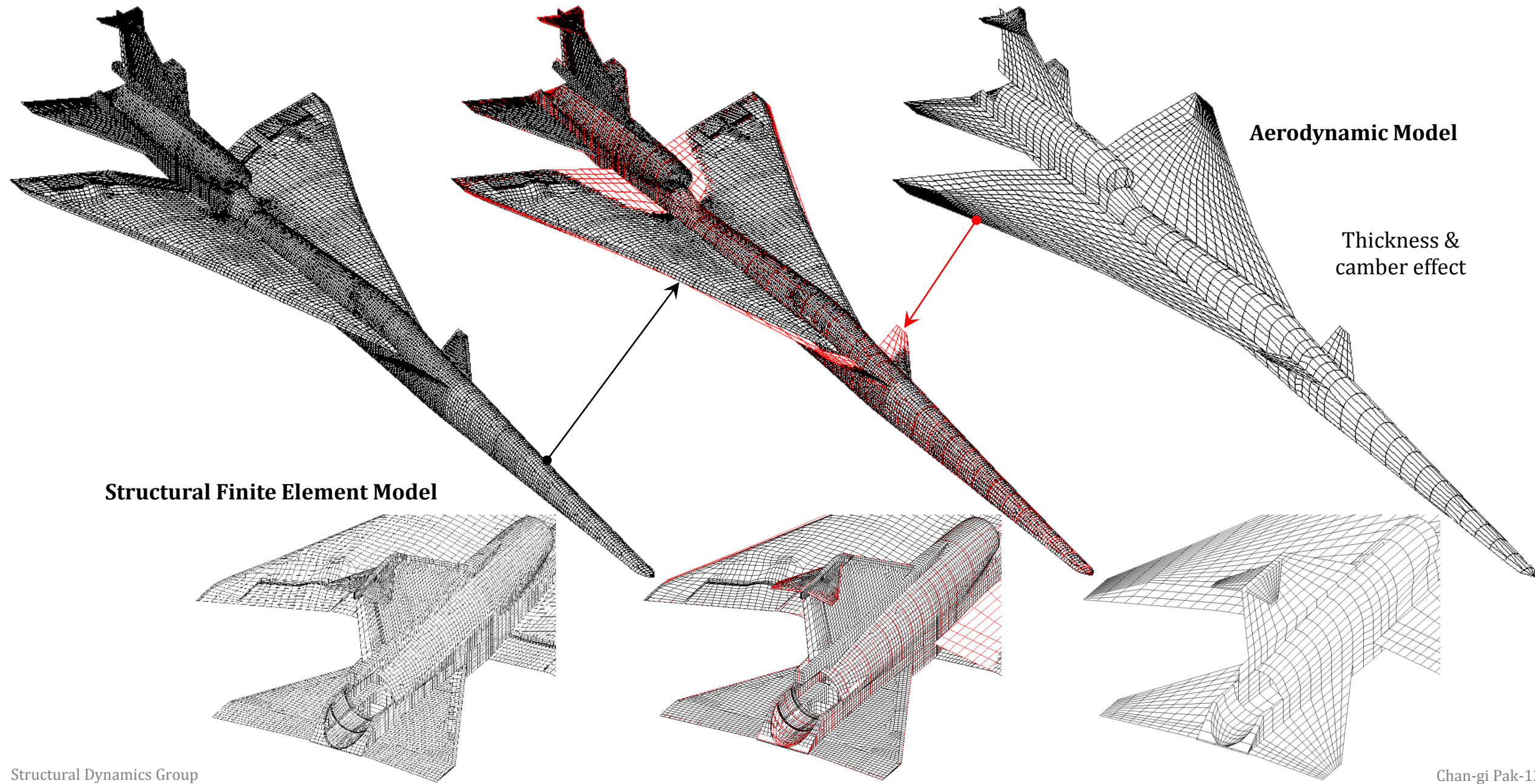



Summary of Natural Frequencies (Baseline Configuration)

Mode	Frequency (Hz)			Notes
	Baseline	Optimum	% difference	
7	5.634	5.633	-0.02	First fuselage bending
9	9.045	9.032	-0.14	First wing bending + forward fuselage vertical bending + stabilator rotation
11	11.97	11.97	0.00	Forward fuselage vertical bending + first wing bending + stabilator rotation (Asymmetric)
15	14.76	14.76	0.00	Stabilator rotation
17	19.23	19.22	-0.05	Wing tip bending + T-tail rotation + flap bending (Asymmetric)
19	20.08	20.08	0.00	T-tail rotation (Asymmetric)
20	20.54	20.55	0.05	Wing tip bending + T-tail rotation + aileron rotation + flap bending + forward fuselage vertical bending (Asymmetric)
22	21.75	21.76	0.05	Aileron rotation + flap rotation + T-tail bending + outboard wing bending torsion
23	22.16	22.16	0.00	Flap rotation + aileron rotation + wing tip bending + T-tail bending (Asymmetric)
25	22.70	22.70	0.00	Flap rotation + aileron rotation + T-tail bending (Asymmetric)
37	30.79	30.75	-0.13	Canard bending
48	42.96	42.97	0.02	T-tail bending (Asymmetric)



Mode 7: 5.634 Hz

Mode 9: 9.045 Hz

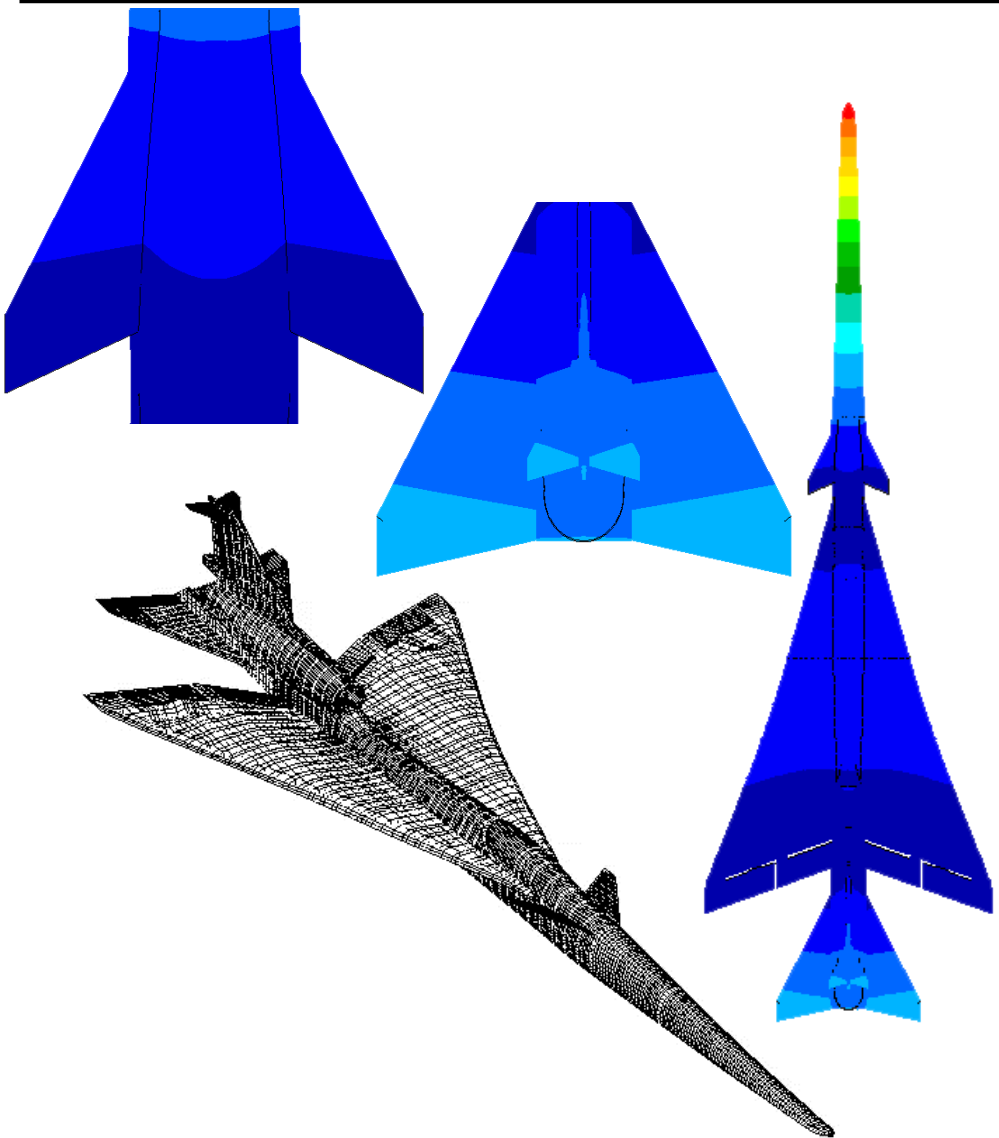

first fuselage vertical bending

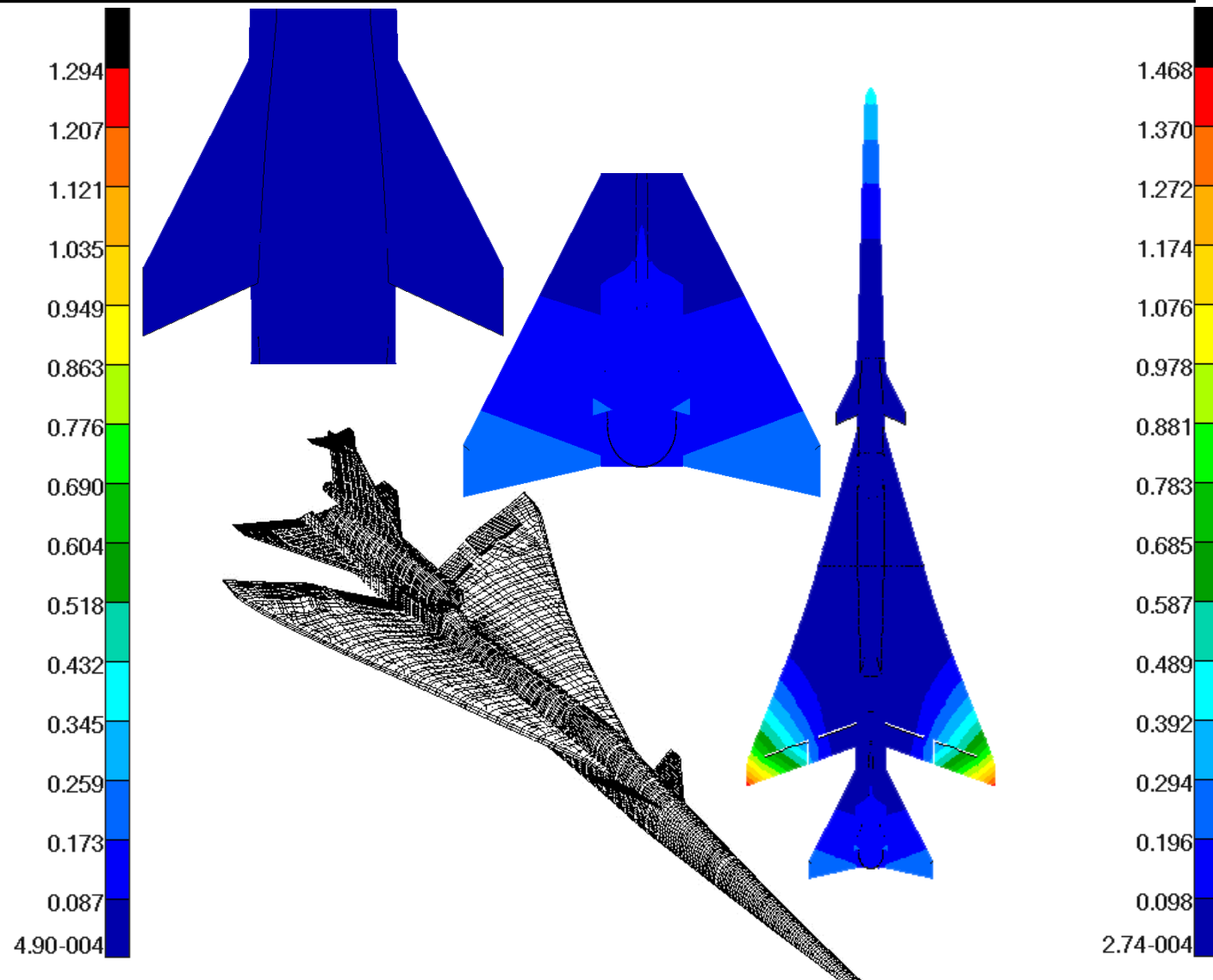

Symmetric first wing bending + forward fuselage vertical bending + horizontal tail rotation (in-phase: forward fuselage & wing)(out-phase: wing and horizontal tail)



Mode 11: 11.97 Hz

Mode 15: 14.76 Hz

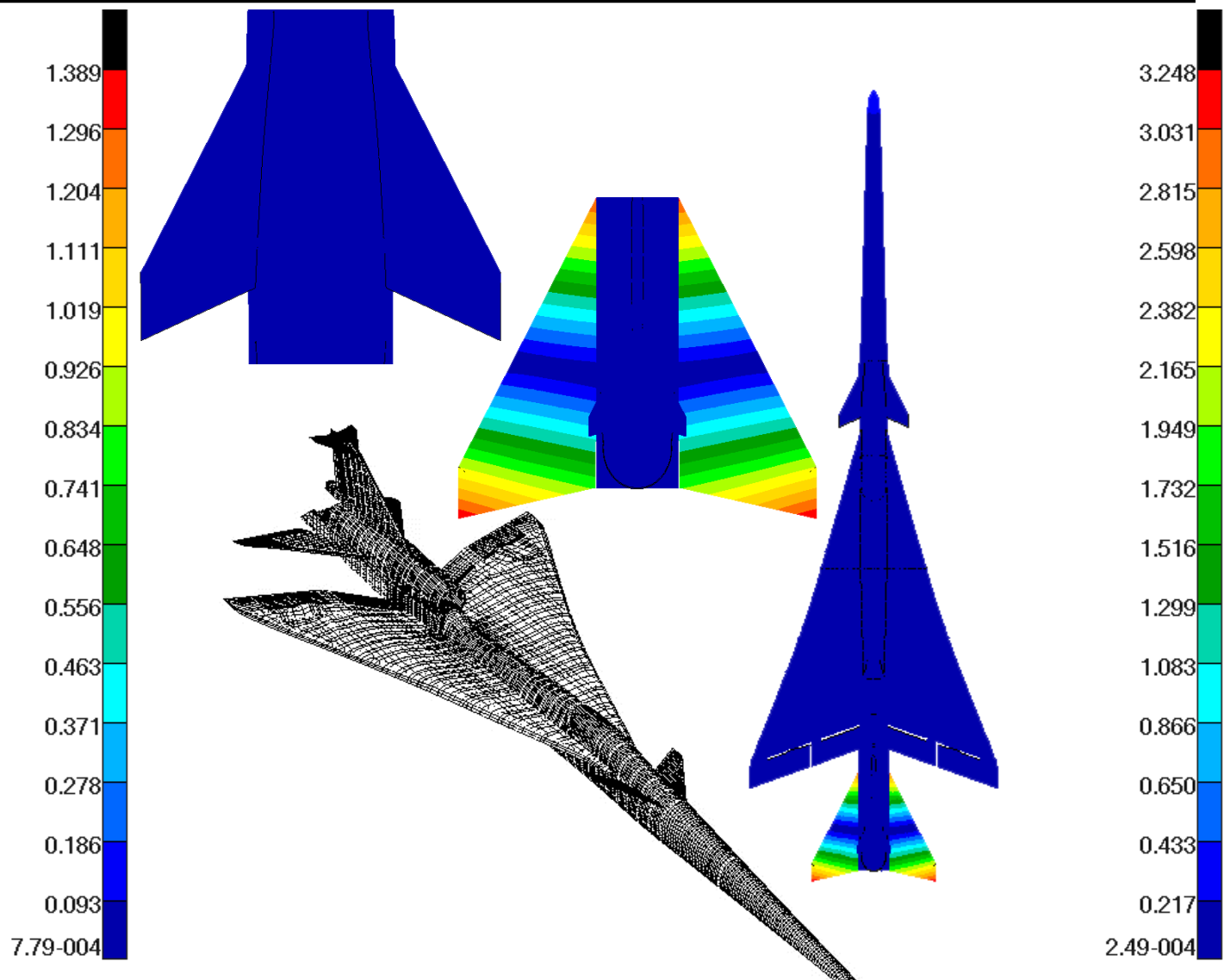
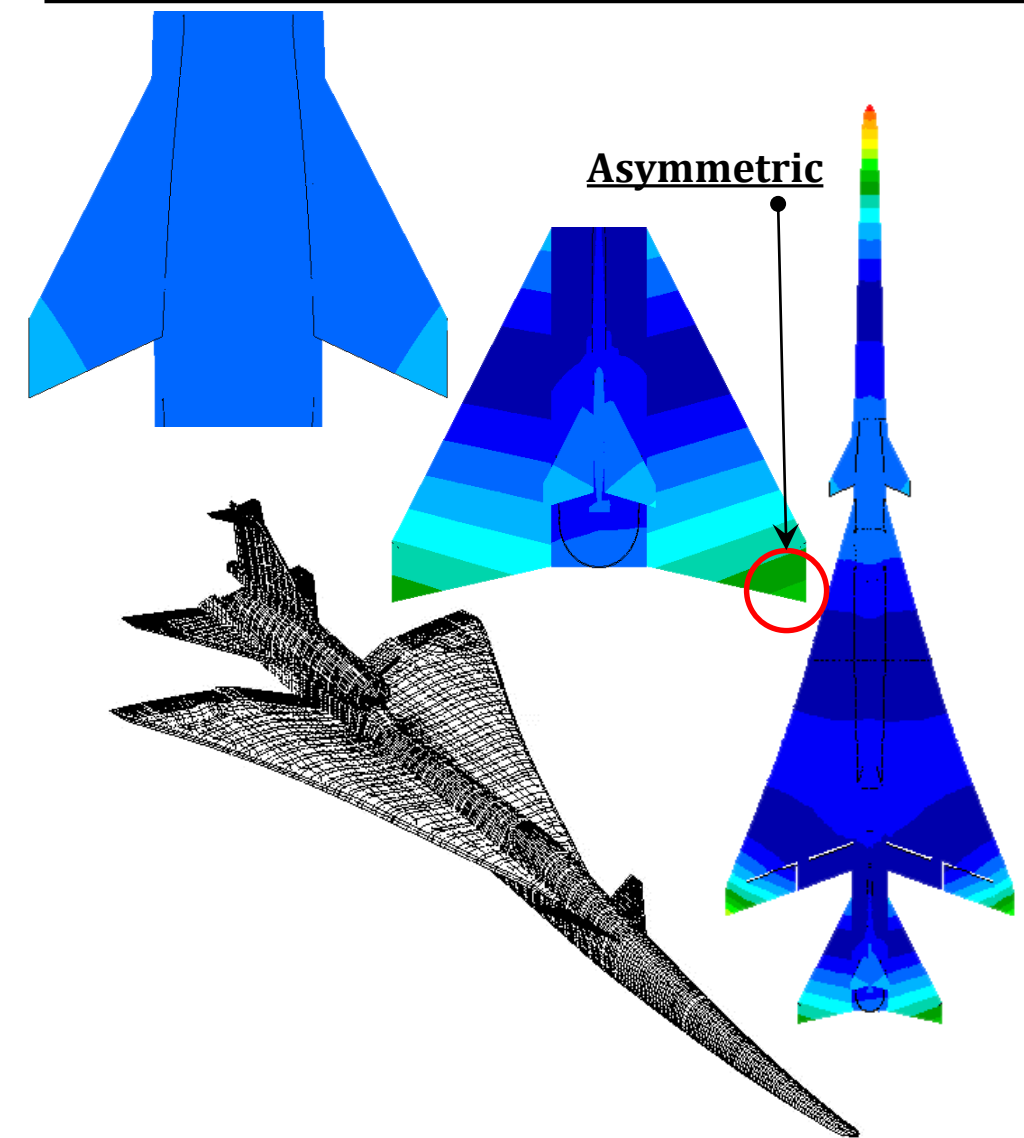

Symmetric first wing bending + forward fuselage vertical bending + horizontal tail rotation (out-phase: forward fuselage & wing)(in-phase: wing and horizontal tail)

Symmetric horizontal tail rotation



Mode 17: 19.23 Hz

Mode 19: 20.08 Hz

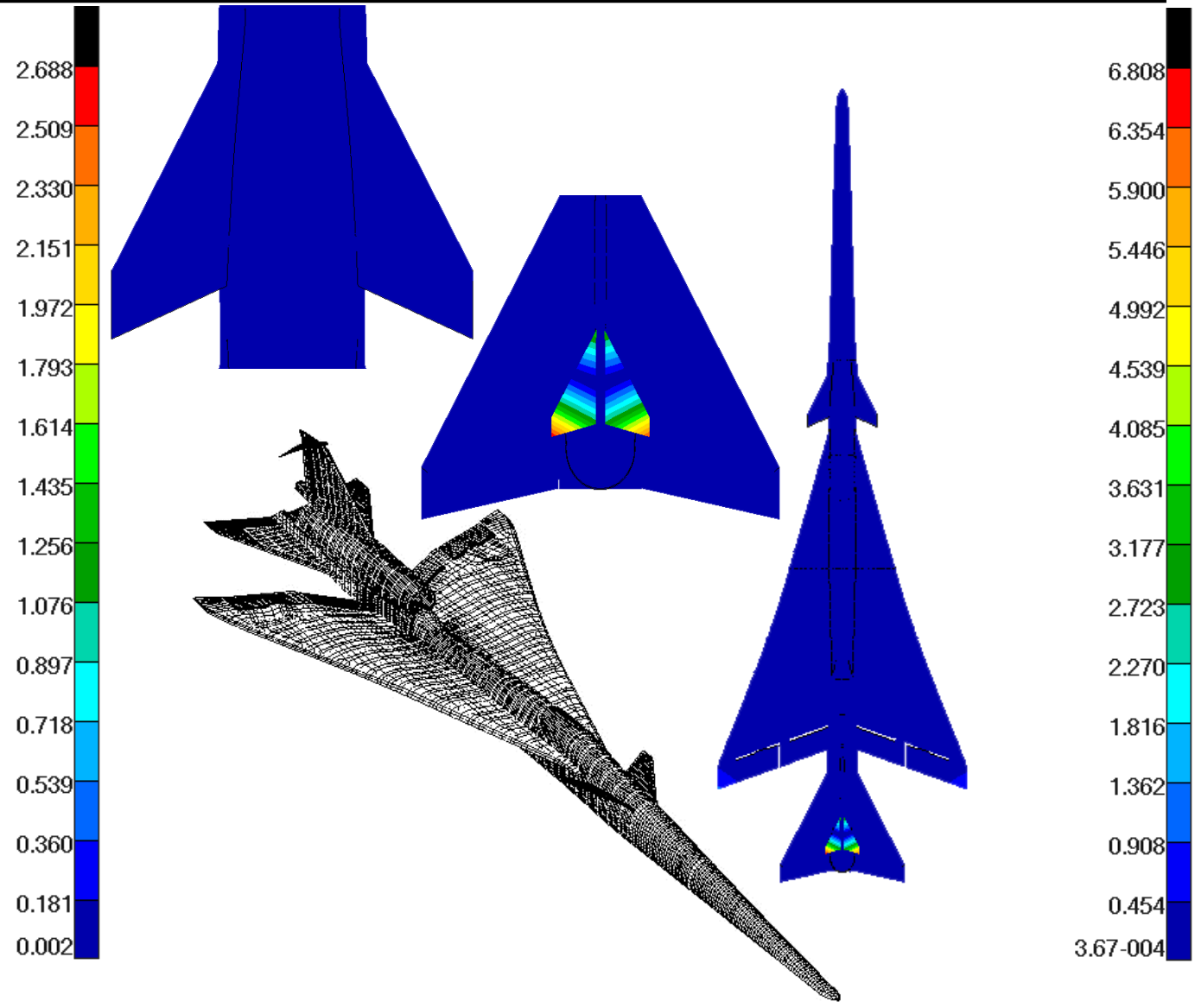
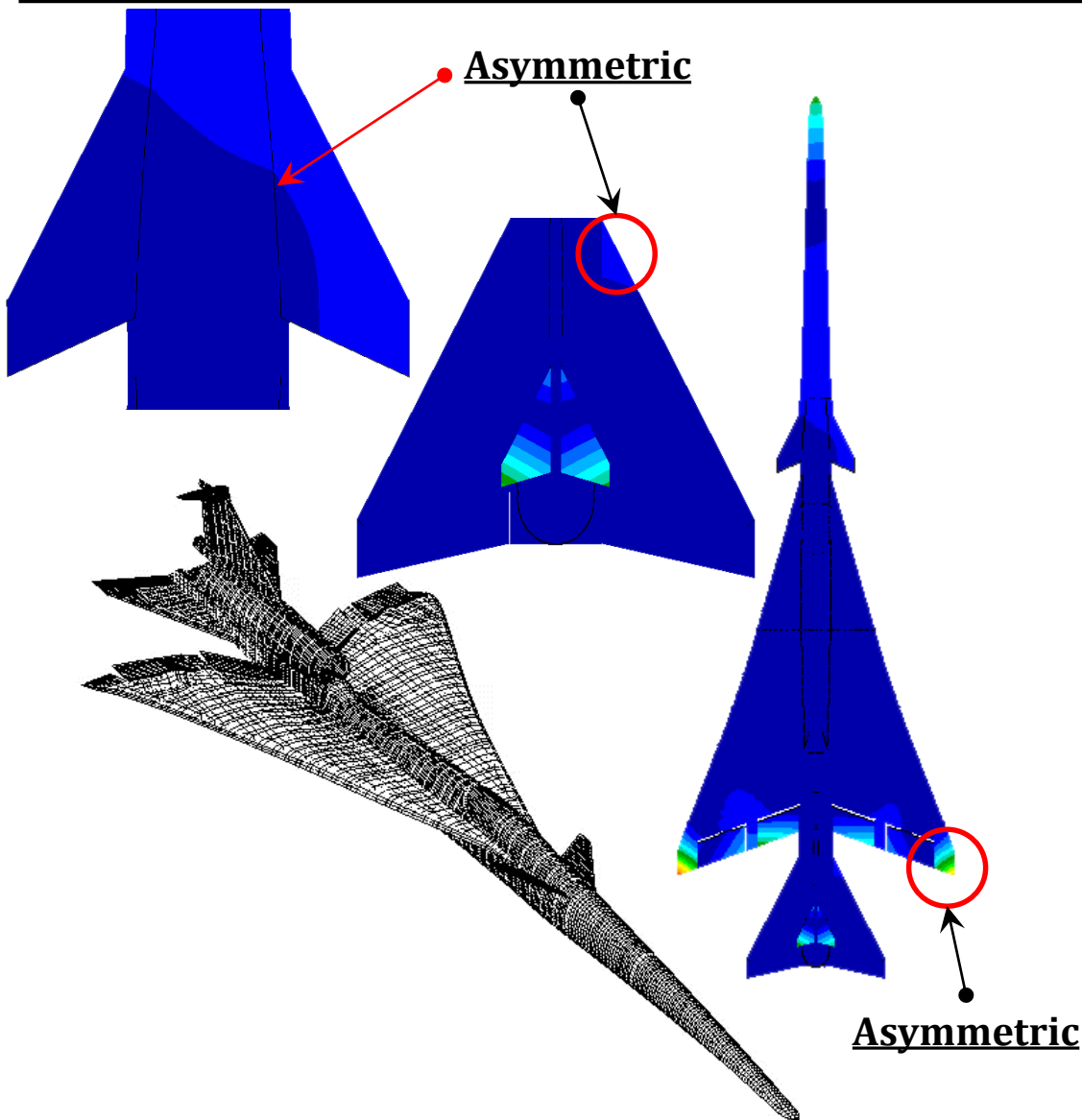

symmetric wing tip bending+Ttail rotation + flap

symmetric ttail rotation



Mode 20: 20.54 Hz

Mode 22: 21.75 Hz

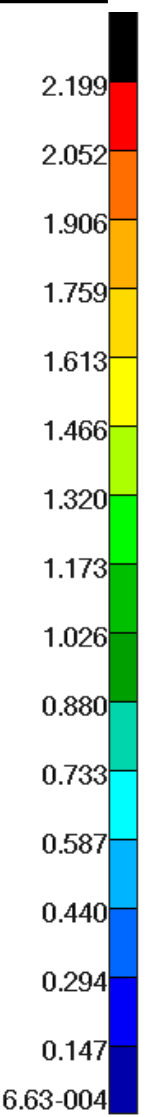
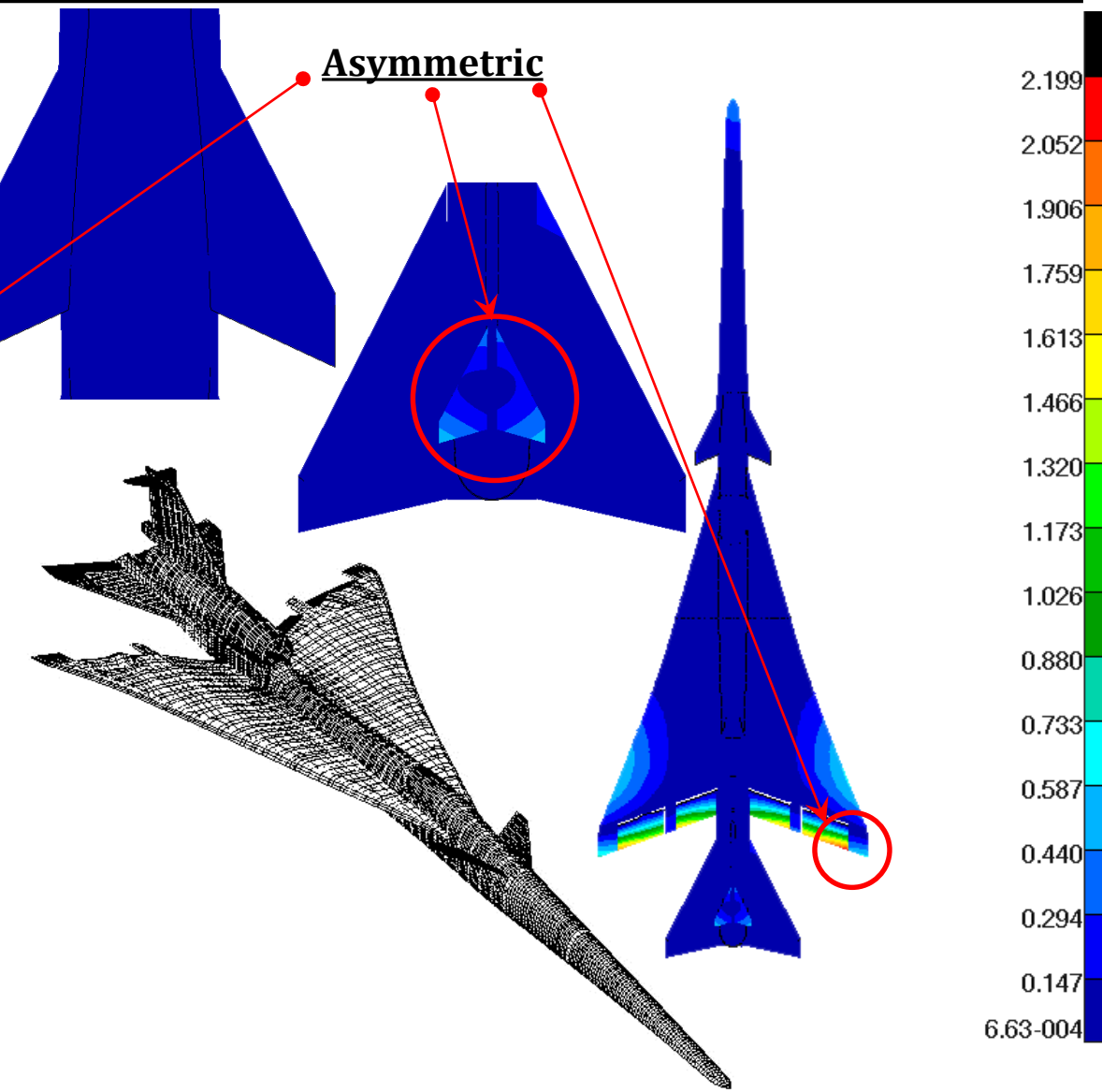
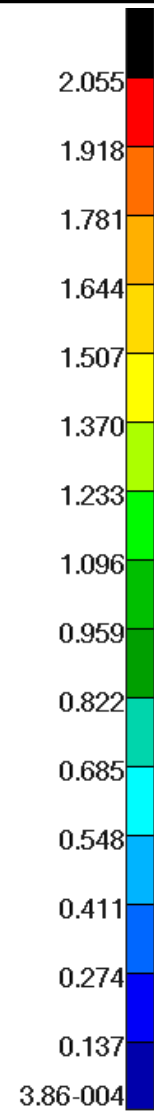
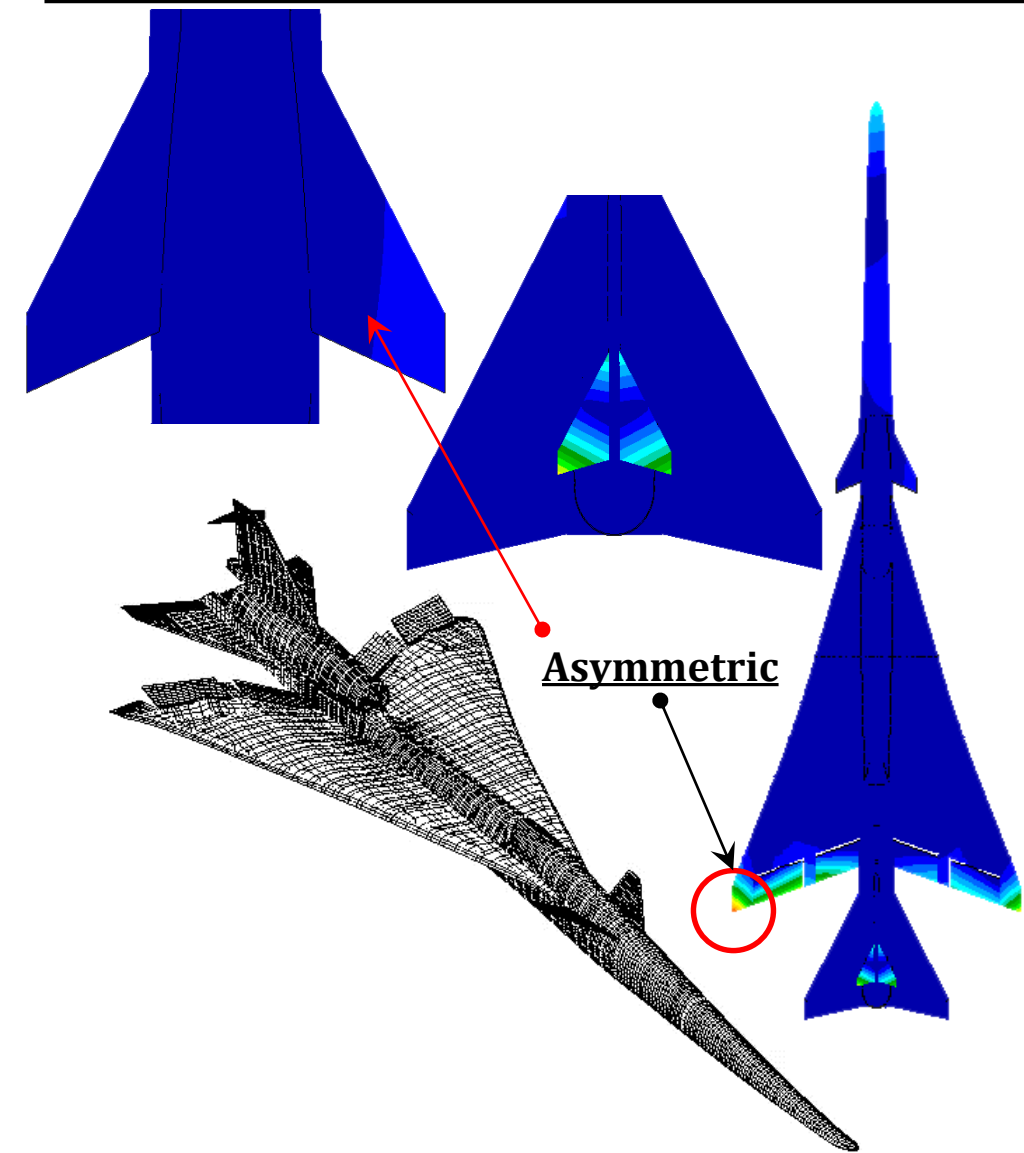

symmetric wing tip bending + ttail rotation flap & airleron rotation + forward fuselage bending + nose landing gear vertical bending (out-phase wing tip & forward fuselage) (out phase wing tip & ttail)

symmetric airleron + flaperon (in-phase)+ttail(pitch +yaw)



Mode 23: 22.16 Hz

Mode 25: 22.70 Hz

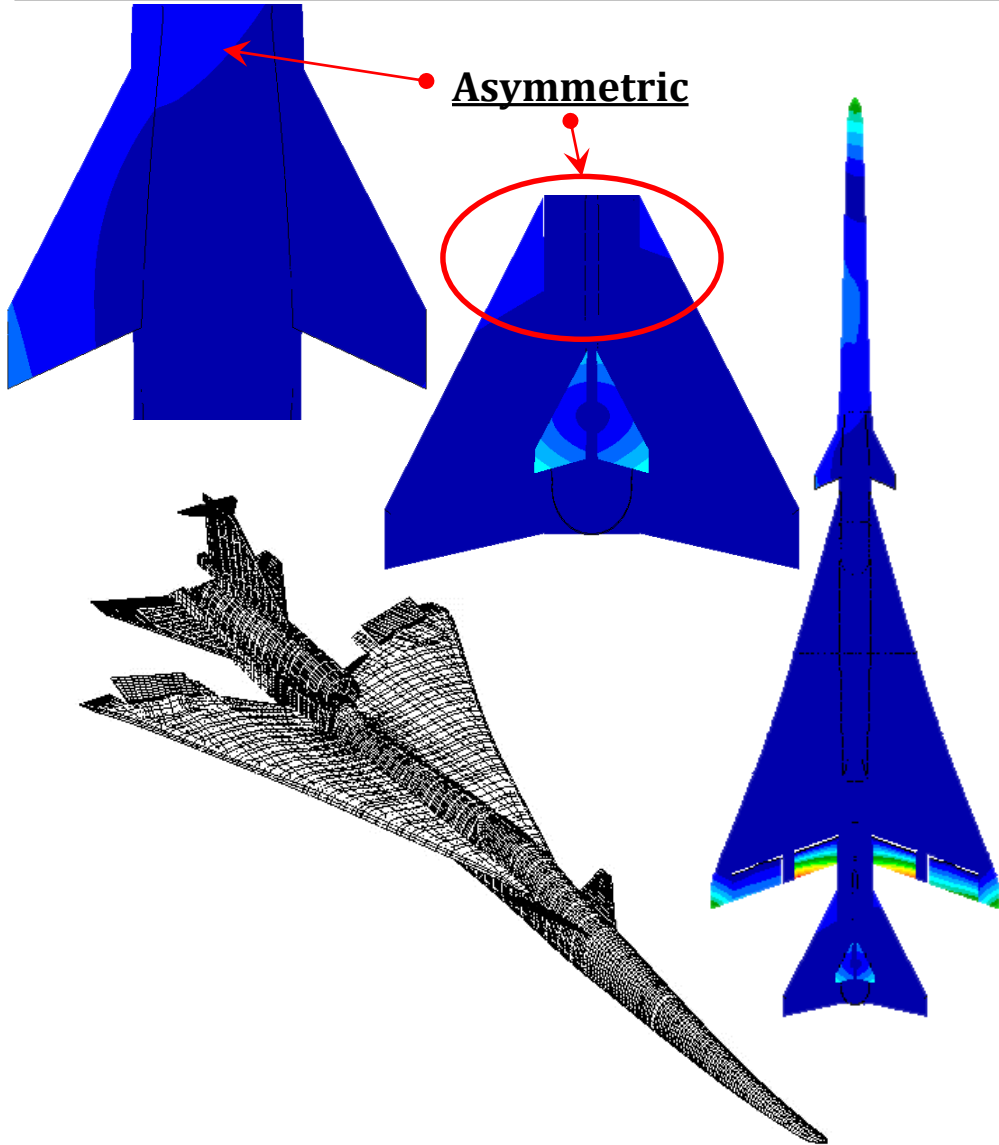

symmetric Flaperon+airleron (out-phase) +ttail(pitch+yaw) +forward fulage and aileron(in-phase)

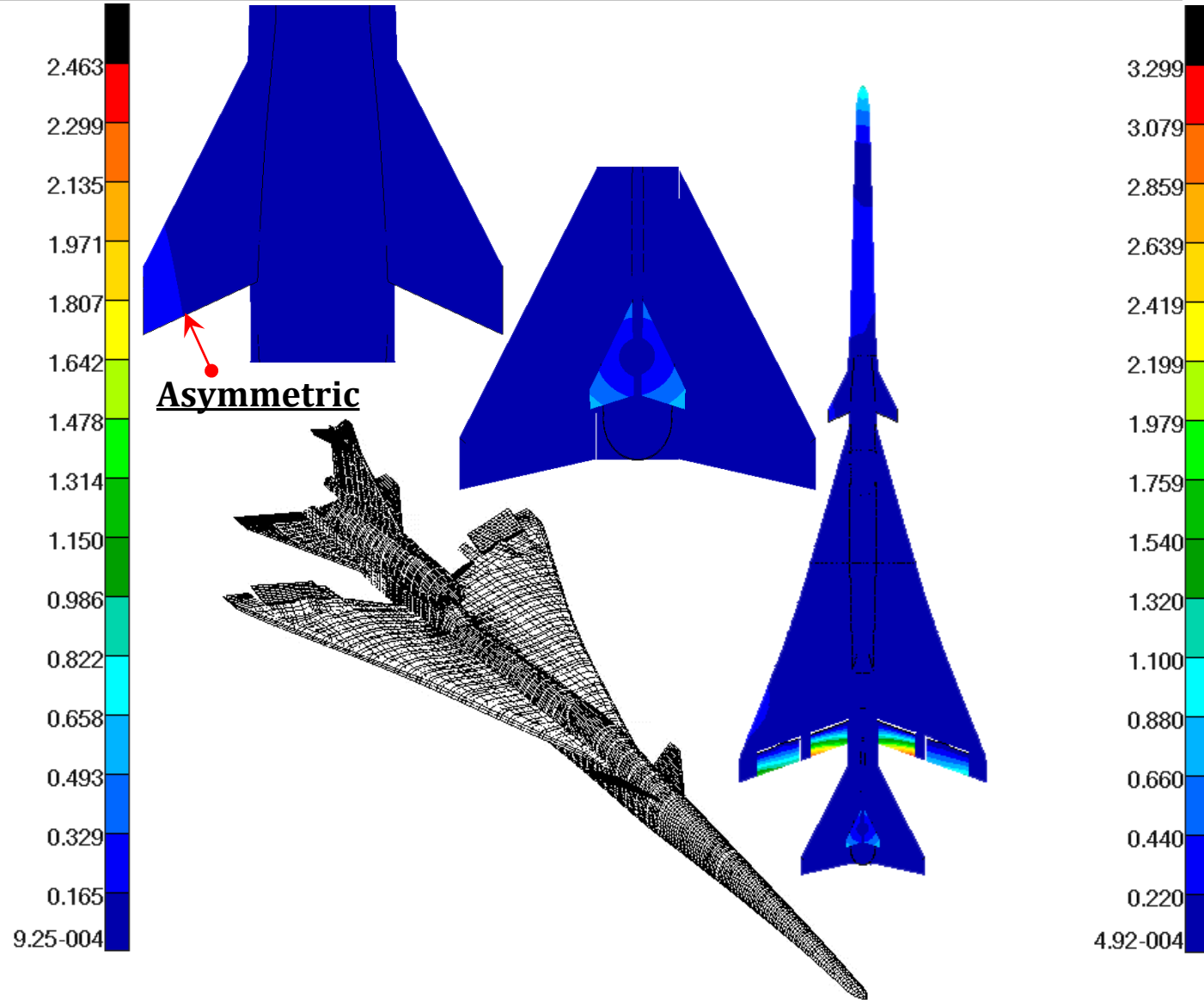

symmetric flaperon+airleron (out-phase)+ttail(pitch+yaw) + forward fulage and aileron(out-phase)



Trim Shape Difference (Baseline Configuration)

- ❑ Weight:
 - ❖ Cruise = 18500.00 lbf
- ❑ Forward CG location
 - ❖ x=836.09 inch, y=-0.1897 inch, z=100.68 inch
- ❑ Mach: 1.42
- ❑ Altitude: 55000 ft
- ❑ Aileron deflection angle: 0.0 deg
- ❑ T-tail deflection angle: 0.0 deg
- ❑ $\{\Delta T\}_{to} \equiv \{T\}_t - \{T\}_o$
 - ❖ $\{T\}_t$ = target trim shape at surface GRIDs
 - ❖ $\{T\}_o$ = trim shape based on optimum jig shape
 - ✓ $\{jig\}_o \equiv \{jig\}_b + [\Phi]\{X\}_o$
 - ✓ $\{jig\}_o \xrightarrow{\text{trim analysis}} \{T\}_o$

X_i	Value
1	0.0
2	0.0
3	0.0
4	0.0
5	0.0
6	0.0
7	0.0
8	0.0
9	0.0
10	0.0
11	0.0
12	0.0
13	0.0
14	0.0
15	0.0
16	0.0

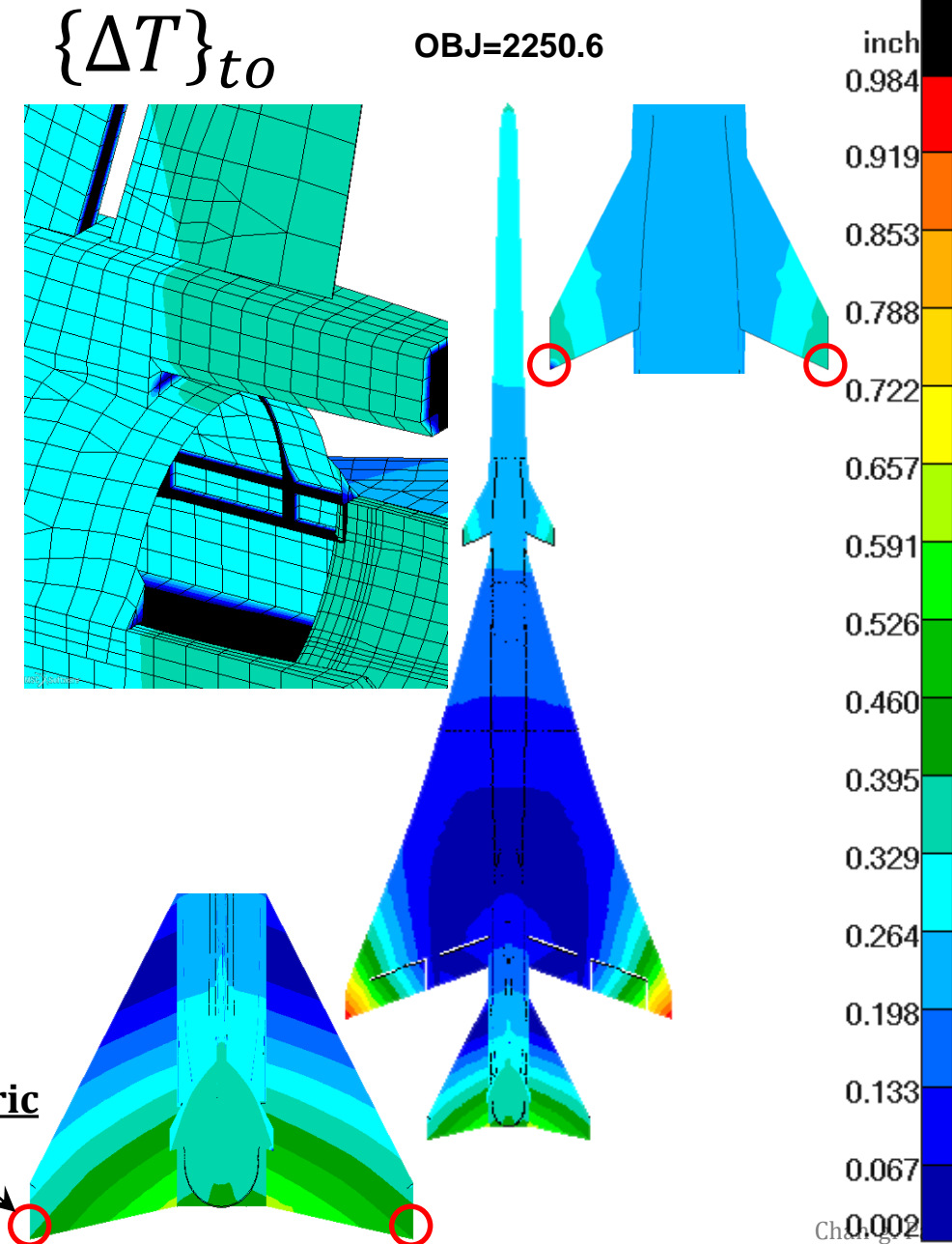



Optimization #1: $\{\Delta T\}_{t_o} = \{T\}_t - \{T\}_o$

Use least-squares surface fitting

OBJ = 14.04

X_i	Value
1	-0.5795
2	-1.5063
3	-1.4565
4	0.4108
5	-1.0492
6	0.2851
7	1.2202
8	.04660
9	0.1273
10	.05808
11	-.02754
12	-.00712
13	0.1212
14	
15	
16	

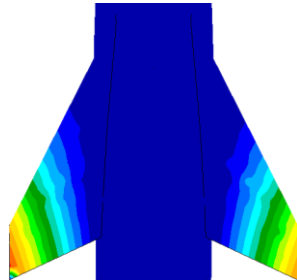
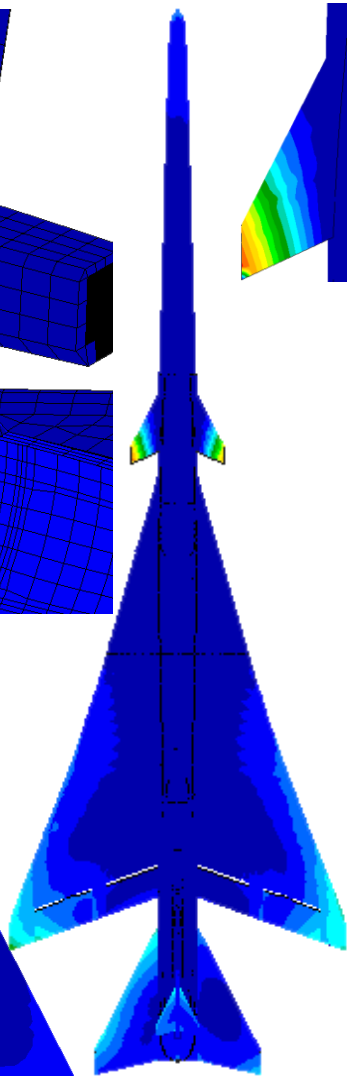
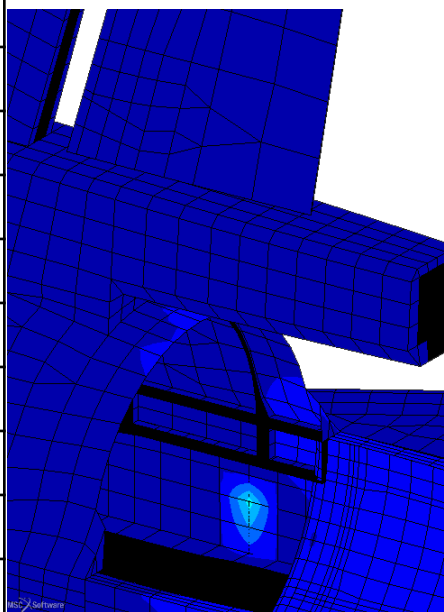

Use Optimization

OBJ = 14.02

X_i	Value
1	-0.5776
2	-1.5078
3	-1.4574
4	0.4106
5	-1.0495
6	0.2848
7	1.2190
8	.04569
9	0.1275
10	.05803
11	-.02746
12	-.00697
13	0.1211
14	
15	
16	

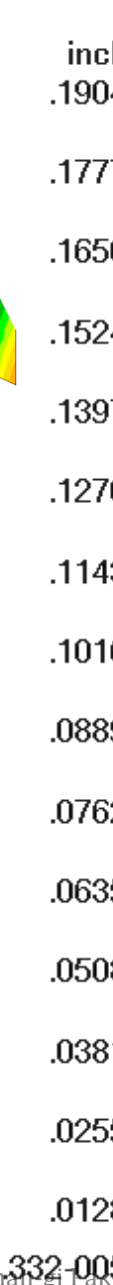
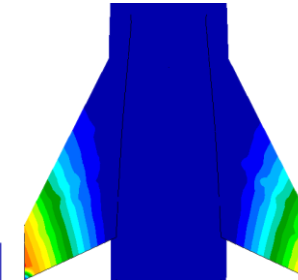
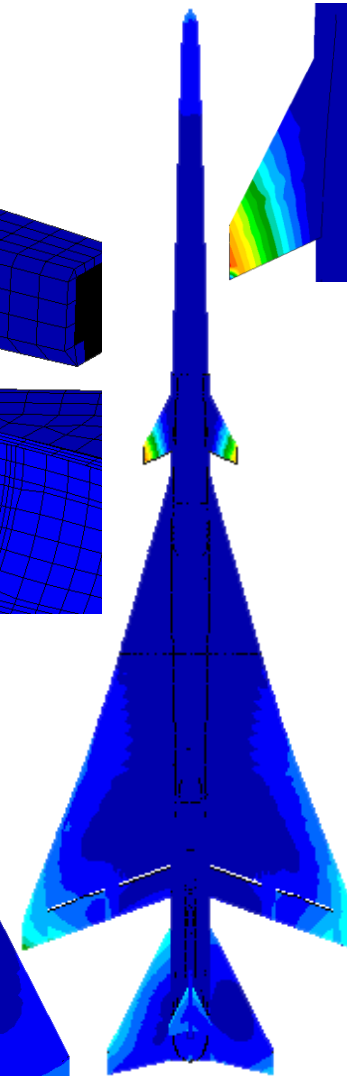
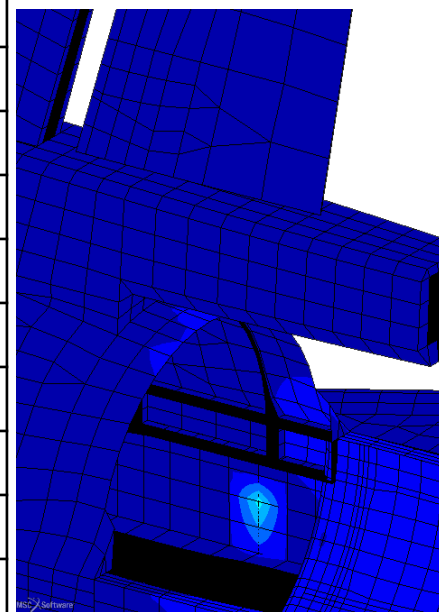

Start Configuration

Optimum Configuration



Mode 37: 30.79 Hz

Mode 48: 42.96 Hz

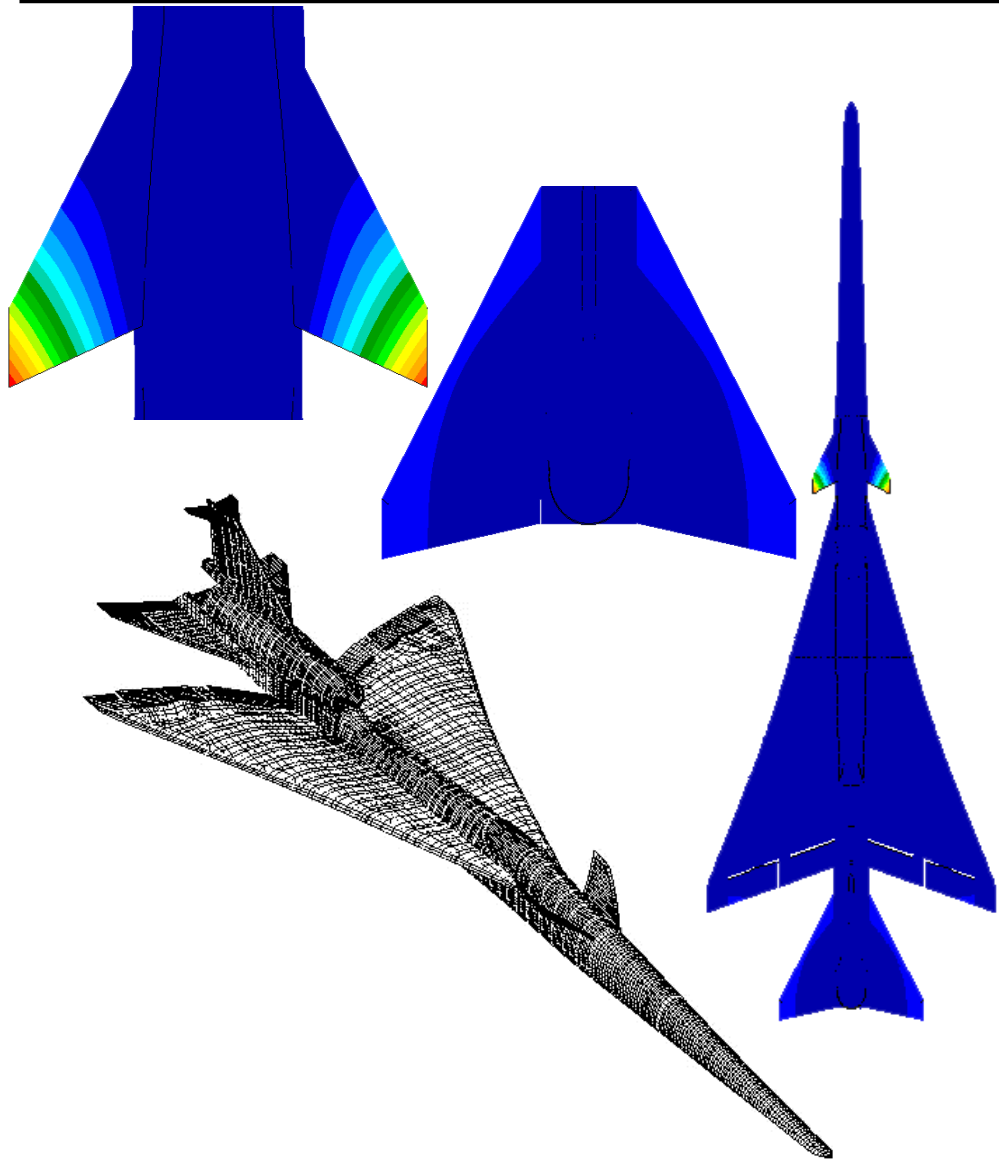

symmetric canard bending

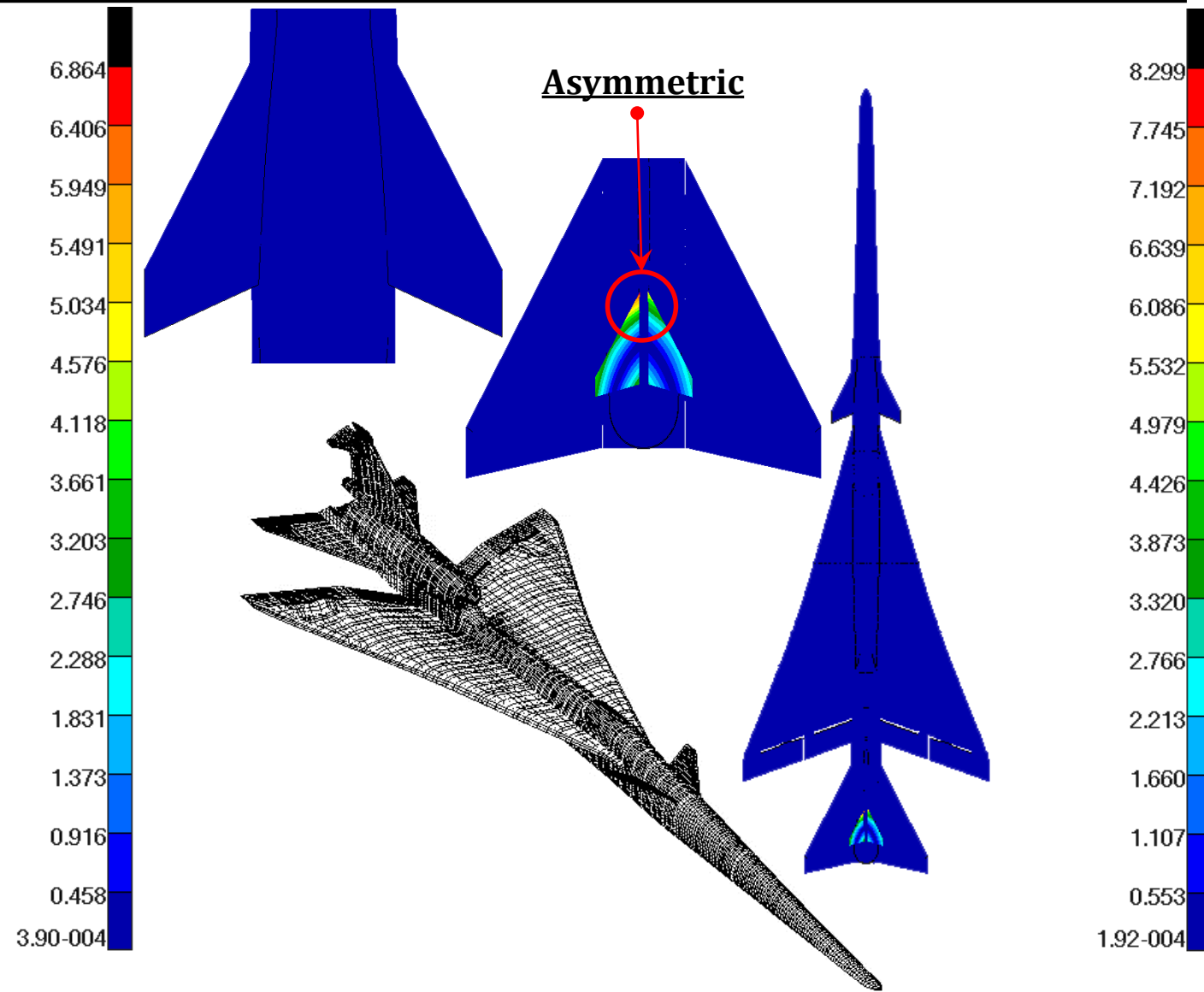

symmetric ttail



Optimization #2: $\{\Delta T\}_{t_o} = \{T\}_t - \{T\}_o$

Use least-squares surface fitting

OBJ=6.255

X_i	Value
1	-0.5783
2	-1.3482
3	-1.3008
4	0.4226
5	-1.0585
6	0.2544
7	1.0823
8	.00555
9	0.1242
10	.02061
11	-0.04842
12	-0.02884
13	0.1055
14	0.2174
15	-0.07665
16	

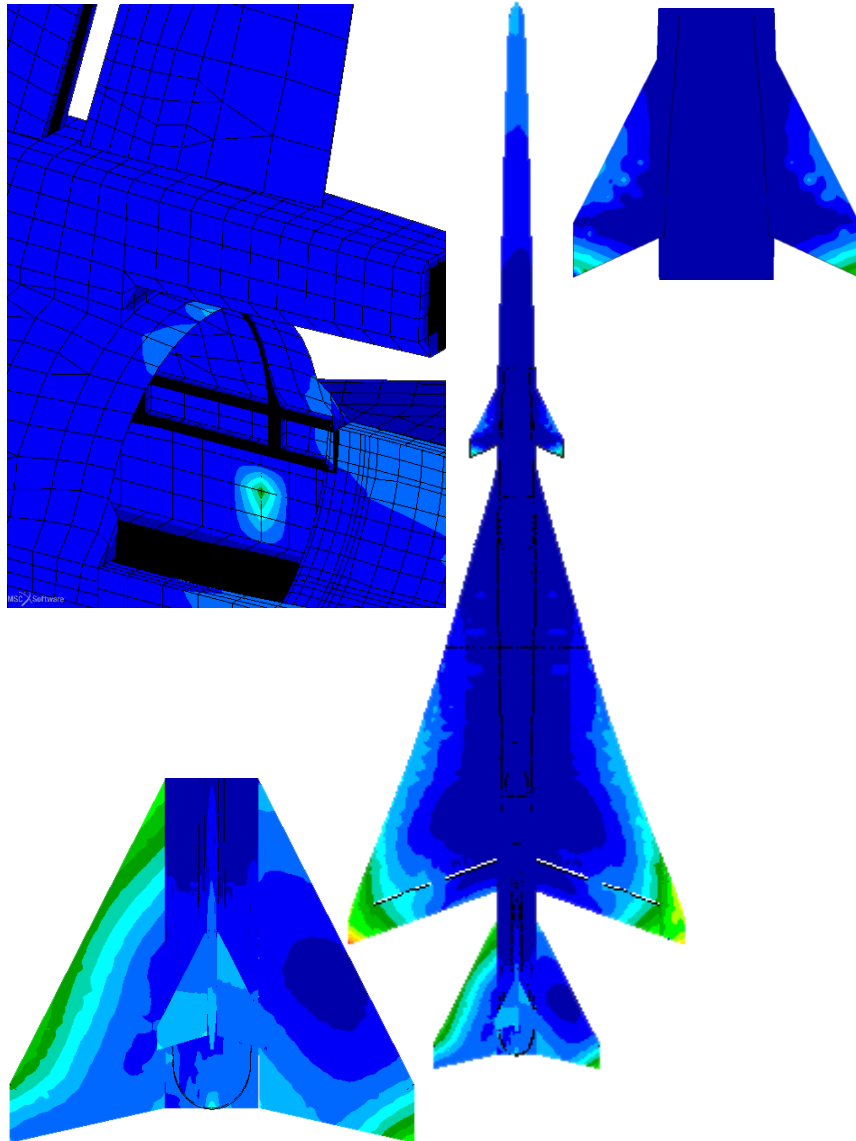

Start Configuration

Use Optimization

OBJ=6.232

X_i	Value
1	-0.5759
2	-1.3489
3	-1.3013
4	0.4228
5	-1.0587
6	0.2541
7	1.0814
8	.00513
9	0.1243
10	.02058
11	-0.04848
12	-0.02907
13	0.1056
14	0.2172
15	-0.07671
16	

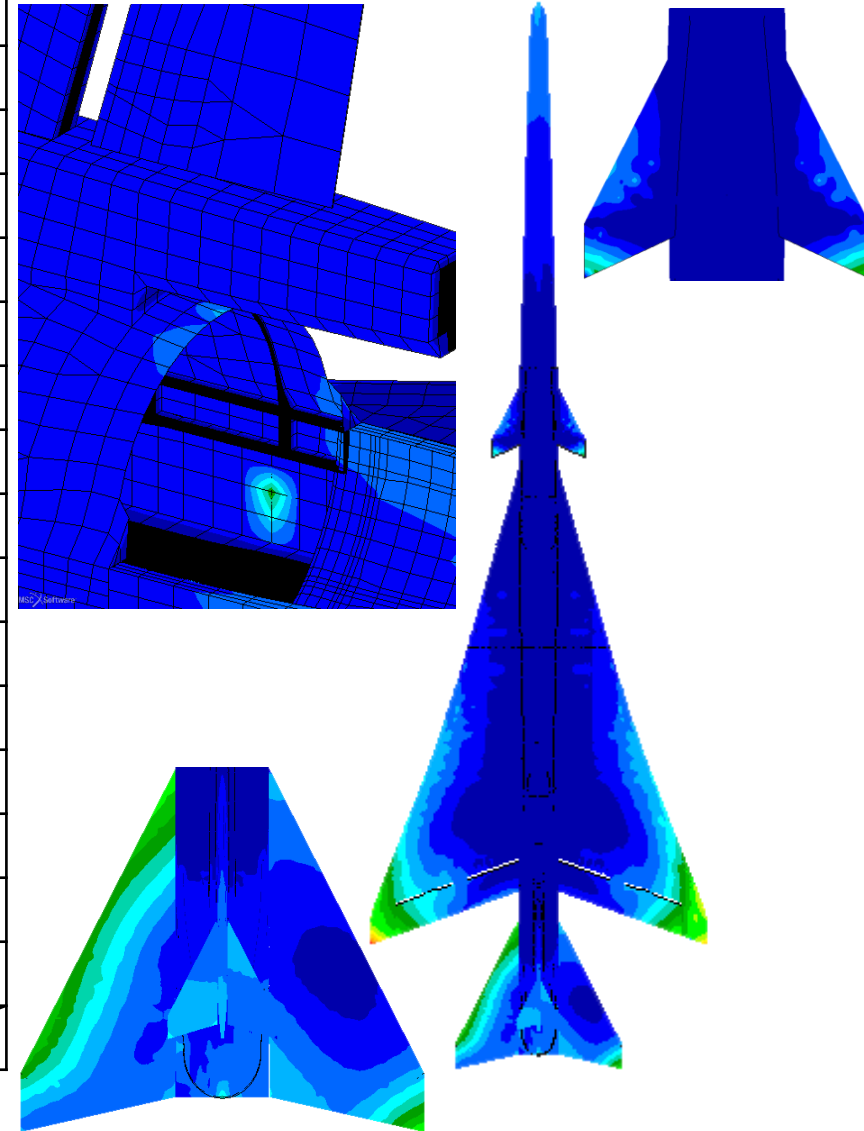

Optimum Configuration



Optimization #1 vs. Optimization #2

OBJ = 14.02

OBJ=6.232

X_i	Value
1	-0.5776
2	-1.5078
3	-1.4574
4	0.4106
5	-1.0495
6	0.2848
7	1.2190
8	.04569
9	0.1275
10	.05803
11	-.02746
12	-.00697
13	0.1211
14	
15	
16	

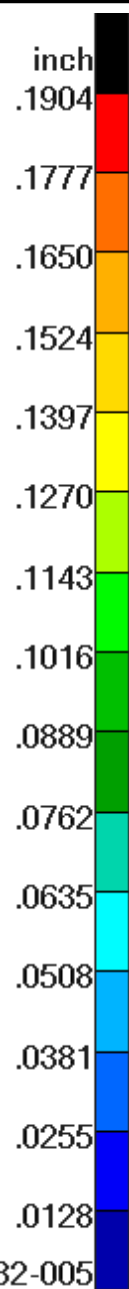
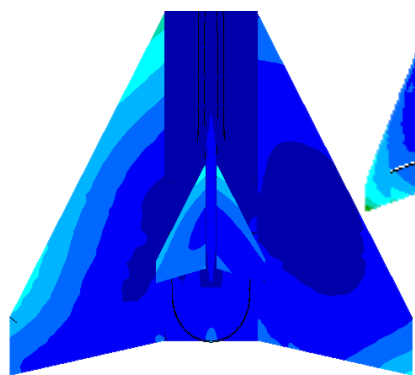
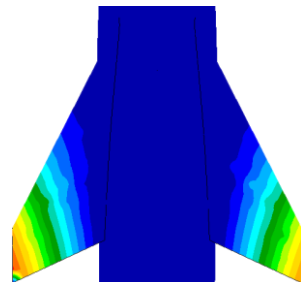
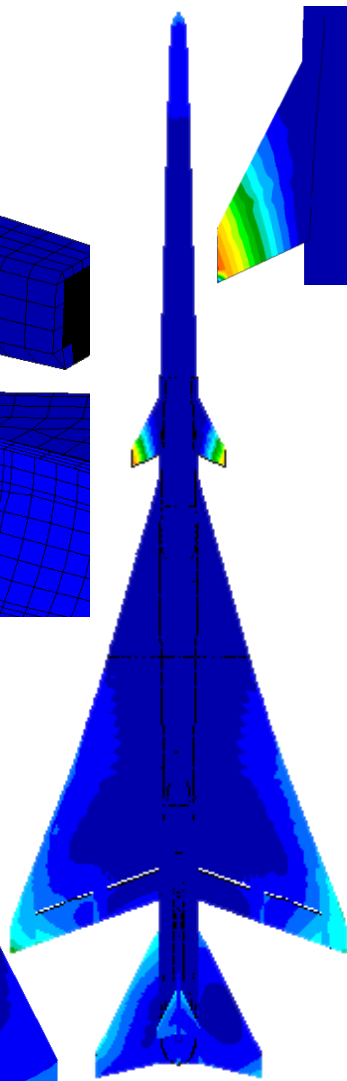
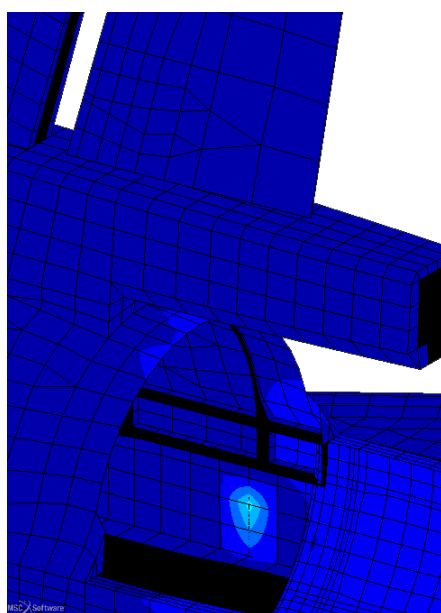

X_i	Value
1	-0.5759
2	-1.3489
3	-1.3013
4	0.4228
5	-1.0587
6	0.2541
7	1.0814
8	.00513
9	0.1243
10	.02058
11	-.04848
12	-.02907
13	0.1056
14	0.2172
15	-.07671
16	

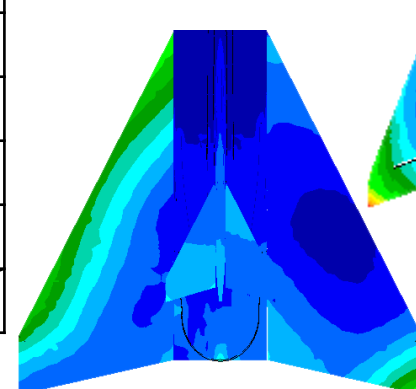
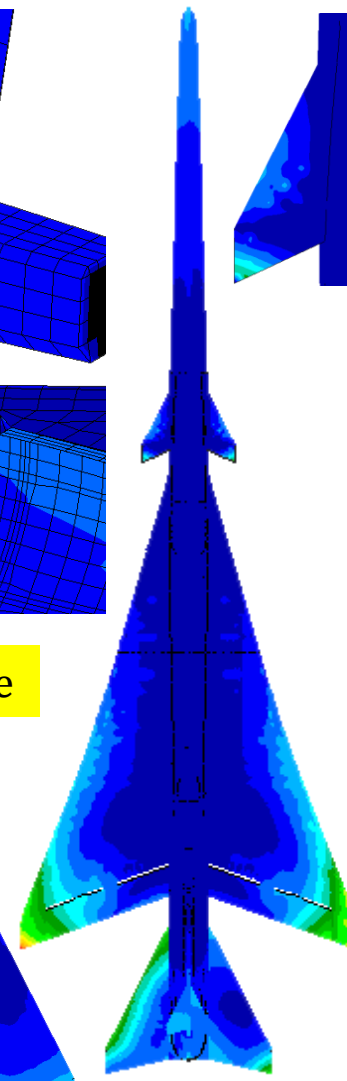
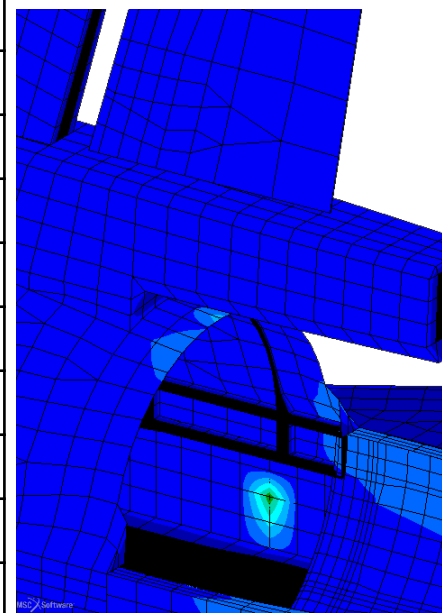

Residual shape



Optimization #3: $\{\Delta T\}_{t_o} = \{T\}_t - \{T\}_o$

Use least-squares surface fitting

OBJ = 0.03269

X_i	Value
1	-0.5768
2	-1.3427
3	-1.2960
4	0.4215
5	-1.0555
6	0.2533
7	1.0775
8	.00525
9	0.1238
10	.02061
11	-0.04840
12	-0.02909
13	.1049
14	0.2161
15	-0.07589
16	-1.002

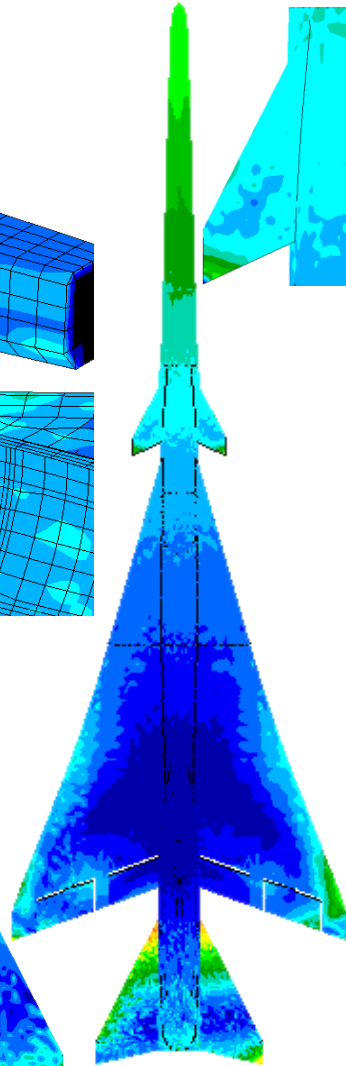
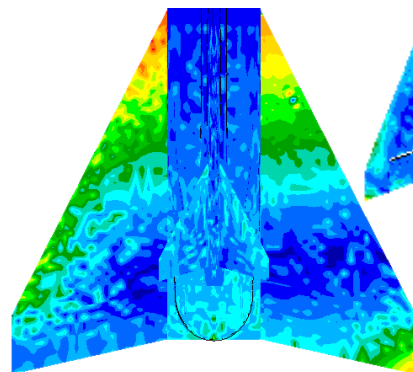
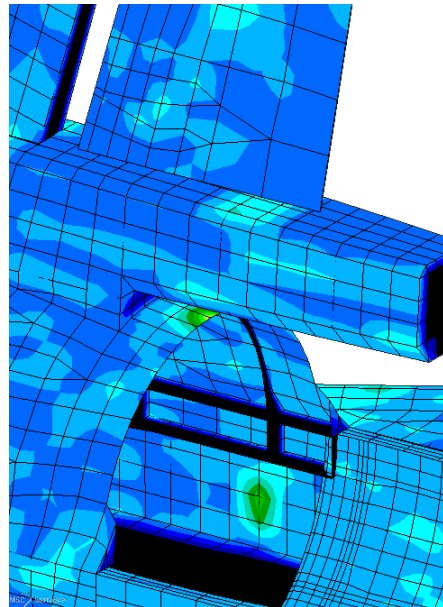

Start Configuration

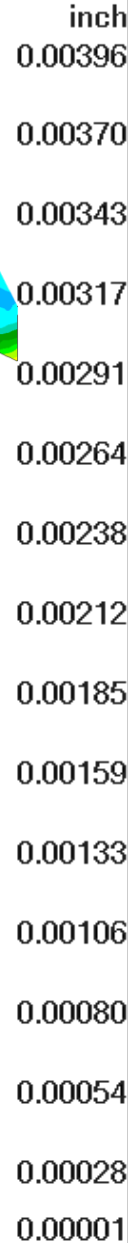

Use Optimization

OBJ = 0.00917

X_i	Value
1	-0.5745
2	-1.3440
3	-1.2969
4	0.4216
5	-1.0559
6	0.2533
7	1.0762
8	.00499
9	0.1238
10	.02041
11	-0.04836
12	-0.02898
13	.1050
14	0.2161
15	-0.07605
16	-1.002

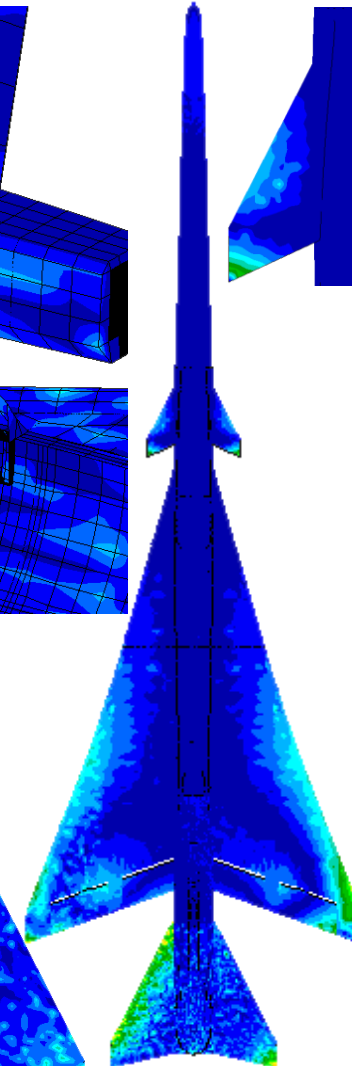
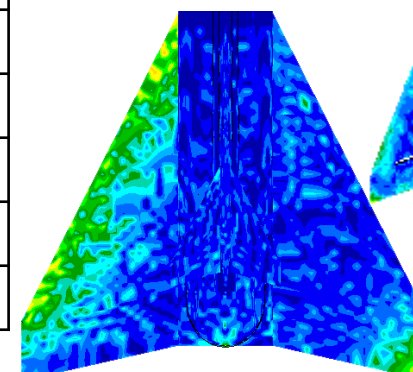
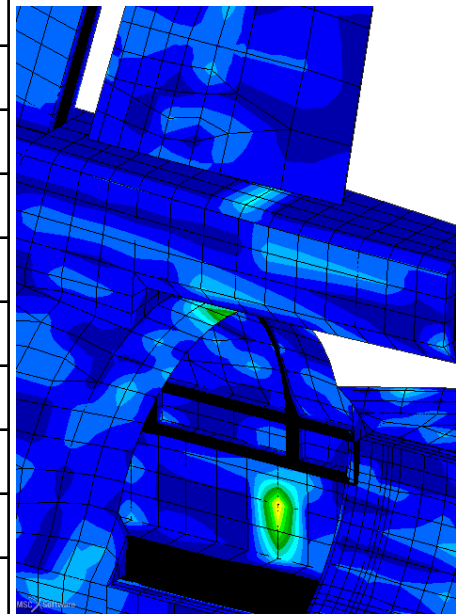

Optimum Configuration





Optimization Results

DESVAR ID	Baseline	Optimization #1		Optimization #2		Optimization #3		Comments
		Start	Optimum	Start	Optimum	Start	Optimum	
1	0.0	-0.5795	-0.5776	-0.5783	-0.5759	-0.5768	-0.5745	Rigid pitch
2	0.0	-1.5063	-1.5078	-1.3482	-1.3489	-1.3427	-1.3440	Stabilator_R
3	0.0	-1.4565	-1.4574	-1.3008	-1.3013	-1.2960	-1.2969	Stabilator_L
4	0.0	0.4108	0.4106	0.4226	0.4228	0.4215	0.4216	Mode 7
5	0.0	-1.0492	-1.0495	-1.0585	-1.0587	-1.0555	-1.0559	Mode 9
6	0.0	0.2851	0.2848	0.2544	0.2541	0.2533	0.2533	Mode 11
7	0.0	1.2202	1.2190	1.0823	1.0814	1.0775	1.0762	Mode 15
8	0.0	.04660	.04569	.00555	.00513	.00525	.00499	Mode 17
9	0.0	0.1273	0.1275	0.1242	0.1243	0.1238	0.1238	Mode 19
10	0.0	.05808	.05803	.02061	.02058	.02061	.02041	Mode 20
11	0.0	-.02754	-.02746	-.04842	-.04848	-.04840	-.04836	Mode 22
12	0.0	-.00712	-.00697	-.02884	-.02907	-.02909	-.02898	Mode 23
13	0.0	0.1212	0.1211	0.1055	0.1056	0.1049	.1050	Mode 25
14	0.0	/	/	0.2174	0.2172	0.2161	0.2161	Mode 37
15	0.0	/	/	-.07665	-.07671	-.07589	-.07605	Mode 48
16	0.0	/	/	/	/	-1.002	-1.002	Residual
Maximum Error (inch)	0.9844	0.1896	0.1904	.0897	.0905	.00396	.00367	/
Objective Function	2250.6	14.04	14.02	6.255	6.232	.03269	.00917	/



Optimum Jig-Shape Configuration with rigid rotation modes

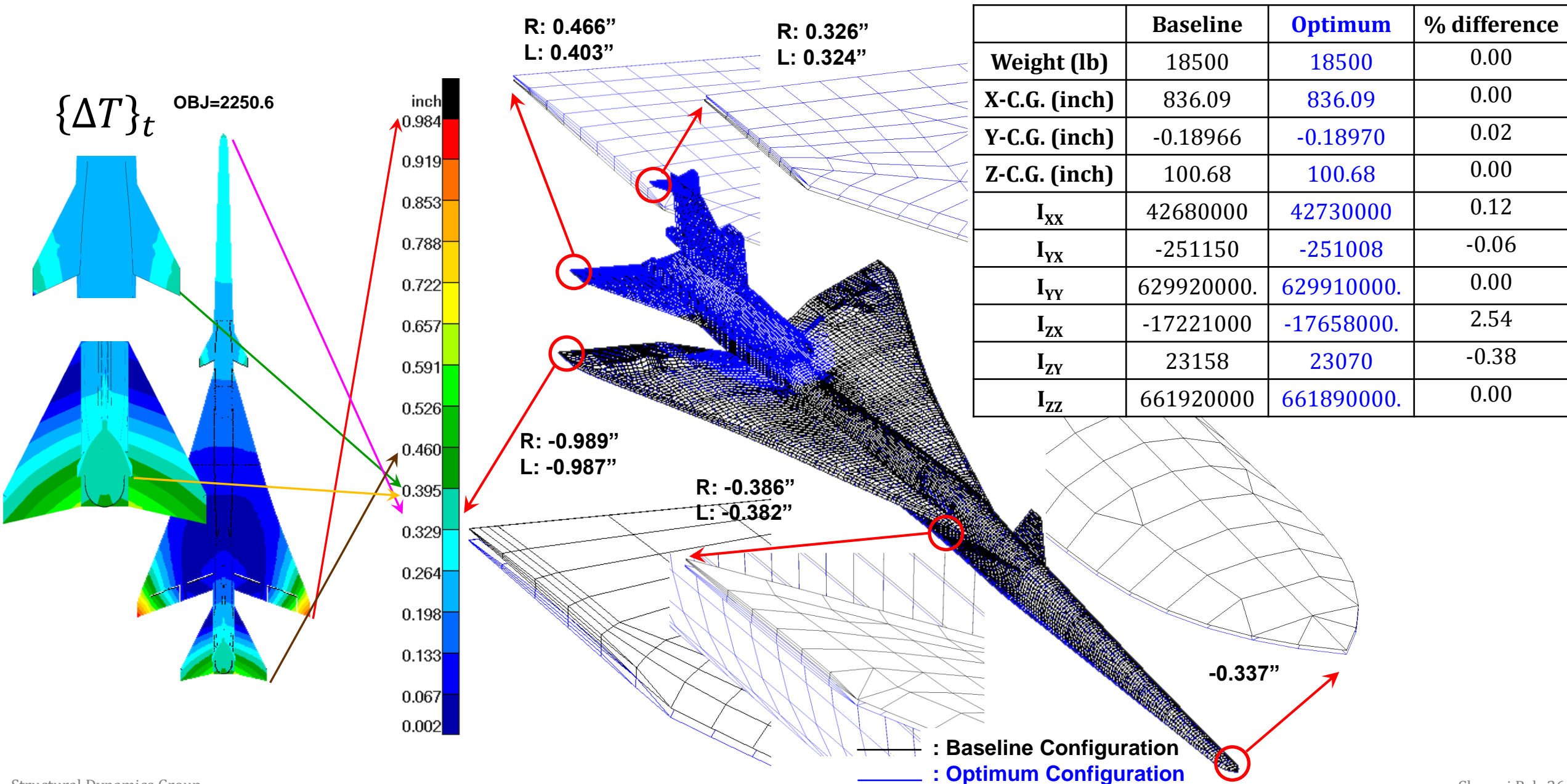



Optimum Jig-Shape Configuration without rigid rotation modes

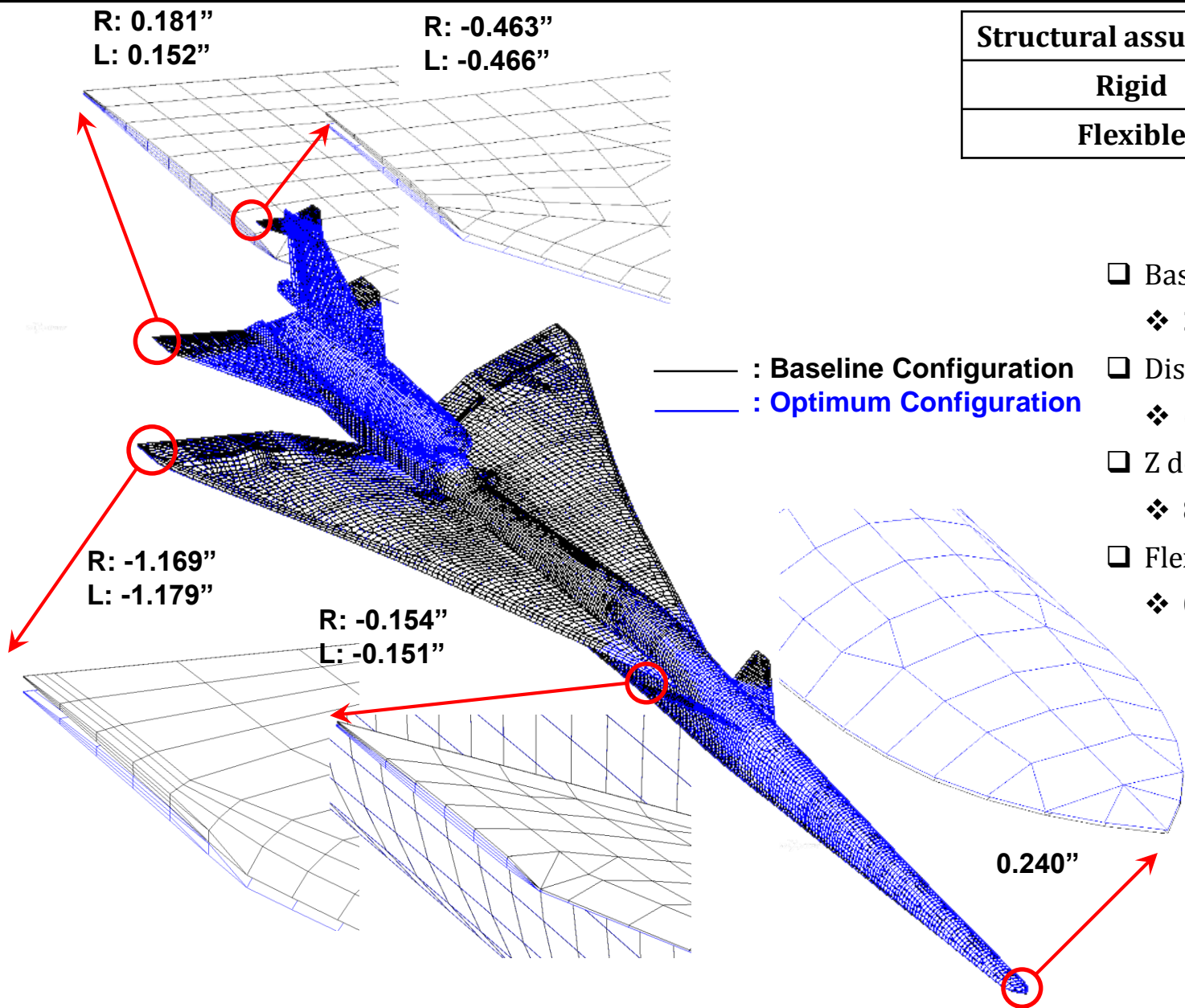

Structural assumption	Baseline (degree)	Optimum (degree)
Rigid	3.0624	3.0624
Flexible	3.1036	3.1033

- ❑ Baseline rigid AOA – Optimum flexible AOA
 - ❖ $3.0624 \text{ deg} - 3.1033 \text{ deg} = -0.0409 \text{ deg} = -0.000713 \text{ rad}$
- ❑ Distance from fuselage nose to center of gravity location
 - ❖ $(25.46, 0.0, 82.51) - (836.09, -0.1897, 100.68) = 810.83 \text{ inch}$
- ❑ Z deflection due to AOA difference
 - ❖ $810.83 \times \tan(-0.000713) = -0.579 \text{ inch} (-0.575 \text{ inch})$
- ❑ Flexible AOA effect at the fuselage nose
 - ❖ $0.240 \text{ inch} - 0.579 \text{ inch} = -0.339 \text{ inch} (-0.337 \text{ inch})$



Summary of Natural Frequencies before and after optimization

Mode	Frequency (Hz)			Notes
	Baseline	Optimum	% difference	
7	5.634	5.633	-0.02	First fuselage bending
9	9.045	9.032	-0.14	First wing bending + forward fuselage vertical bending + stabilator rotation
11	11.97	11.97	0.00	Forward fuselage vertical bending + first wing bending + stabilator rotation (Asymmetric)
15	14.76	14.76	0.00	Stabilator rotation
17	19.23	19.22	-0.05	Wing tip bending + T-tail rotation + flap bending (Asymmetric)
19	20.08	20.08	0.00	T-tail rotation (Asymmetric)
20	20.54	20.55	0.05	Wing tip bending + T-tail rotation + aileron rotation + flap bending + forward fuselage vertical bending (Asymmetric)
22	21.75	21.76	0.05	Aileron rotation + flap rotation + T-tail bending + outboard wing bending torsion
23	22.16	22.16	0.00	Flap rotation + aileron rotation + wing tip bending + T-tail bending (Asymmetric)
25	22.70	22.70	0.00	Flap rotation + aileron rotation + T-tail bending (Asymmetric)
37	30.79	30.75	-0.13	Canard bending
48	42.96	42.97	0.02	T-tail bending (Asymmetric)



Conclusion

- ❑ In this study, the jig-shape optimization is performed using the two step approach.
 - ❖ The first step is computing the starting design variables using the **least squares surface fitting technique**.
 - ❖ The next step is the fine tune of the jig-shape using the **numerical optimization procedure**.
 - ❖ Assume **unconstrained** optimization
 - The maximum frequency change due to the jig-shape optimization is less than 0.14%.
 - The minor changes in mass moment of inertia are observed. (mostly less than 0.38%; maximum 2.54%)

- ❑ Sixteen basis function are used in this jig-shape optimization study.
 - ❖ Total of **twelve symmetric mode shapes** of the cruise weight configuration. (Asymmetric shapes exist)
 - Fitting trim deformation
 - ❖ Three basis functions for trim variables (**rigid pitch shape, rigid left and right stabilator rotation shapes**)
 - Fitting flexibility effect on trim variables
 - ❖ **A residual shape** is also selected as a basis function.

- ❑ The maximum trim shape error of **0.9844"** at the starting configuration becomes **0.00367"** at the end of the third optimization run.

Questions?

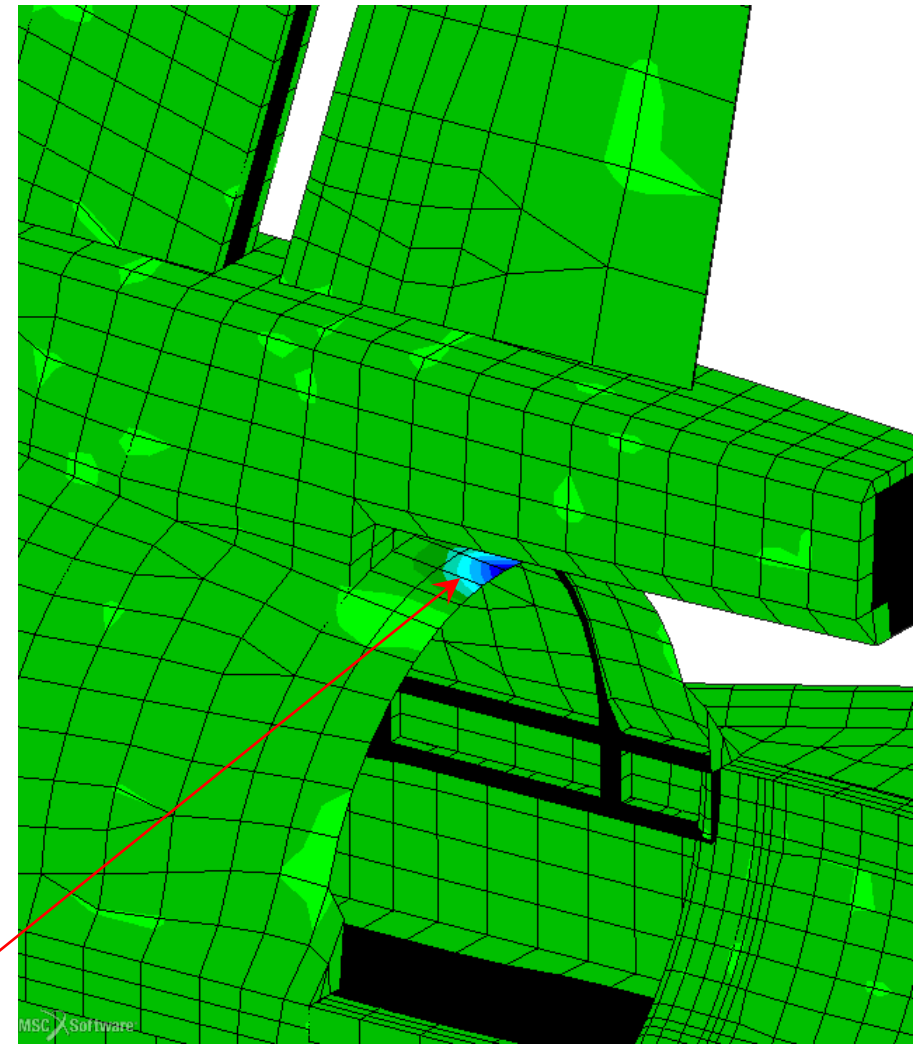
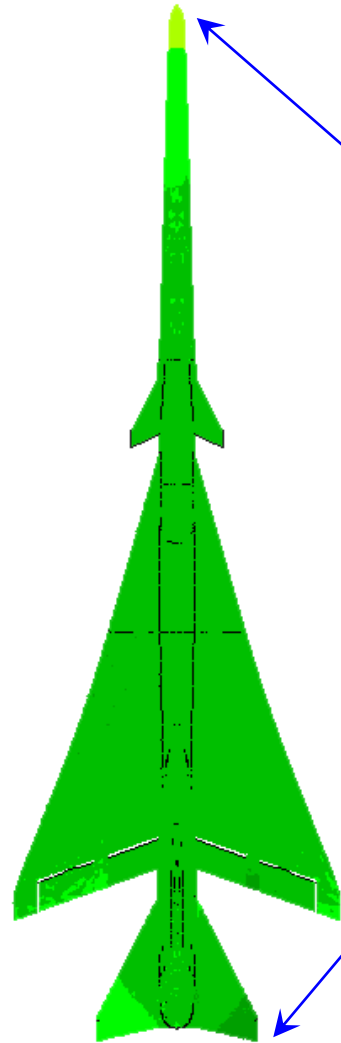

Trim Shape Error