



Tissue Preservation Assessment Preliminary Results:

Speakers: Ruth Globus and
Sylvain Costes

RR Workshop at ASGSR meeting

Oct. 2017

Outline: Globus

- Pre-flight groundbased testing done (Choi et al)
 - For gene expression (RIN values)
 - For protein
- Protocols/methods of preservation to date: freezing profiles from cold stowage
- Overview results from RR1- validation
 - RIN values
 - qRT-PCR and enzyme levels
- Summary of findings on sample quality from BSP-PI's

Pre-flight groundbased testing:

Choi et al. PlosOne 2016

- Objectives:
 - Designed to test potential delays in on-orbit dissections and preservation
 - “Bonus” science: worked out conditions to preserve carcass (intact or dissected) under fast-freeze conditions

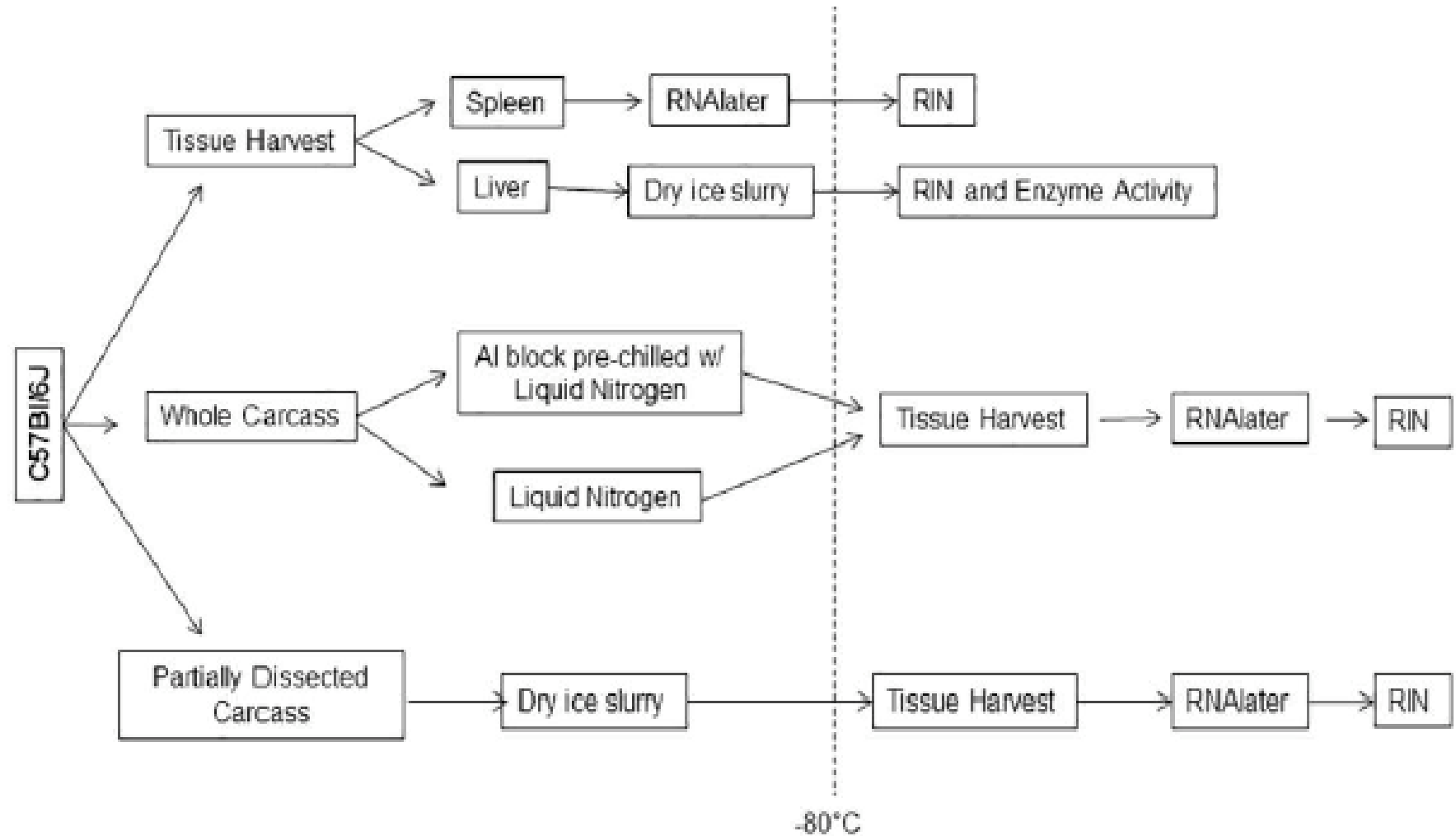

RR1 Experimental Design for on-orbit sample retrieval for Validation

Primary objective RR1 Validation Mission to demonstrate:
Liver-dissection and fast freezing
Spleen-dissection and preservation in RNAlater

31-2 days in space

NASA VALIDATION MICE
10 C57BL/6J mice
(female, 16wk old)

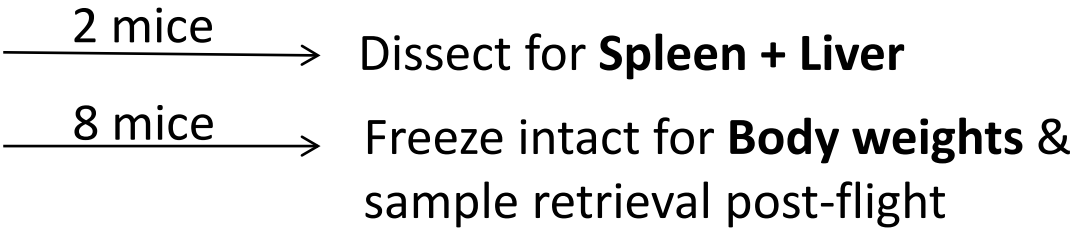

21-22 days in space

5 **CASIS** Control (WT) strain
5 **CASIS** Genetically modified strain (MuRF1 KO)
(female, 32 wk old)

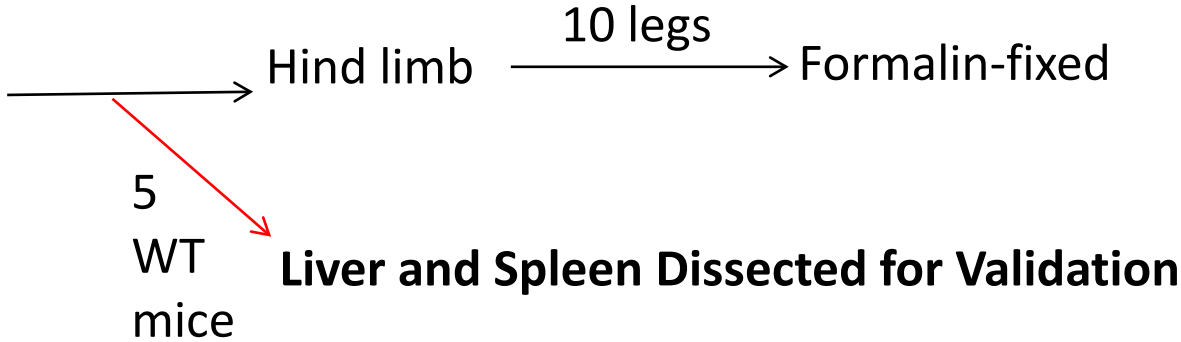

On orbit sample freezing methods

Cold Stowage kit to freeze samples (livers and carcasses) in MSG

Mini Coldbag

- Passive low temperature science storage. MCB was not pre-chilled.



Mini Coldbag

Ice Bricks

- Solid-liquid phase change material in a hard plastic rectangular container compatible with the cold stowage systems. Ice bricks were pre-chilled in the glacier ($\sim -150^{\circ}\text{C}$)
- 3 ice bricks were used for each mini coldbag.



Ice Brick assembly

Carcass Freezing



- Carcasses were wrapped with two layers of aluminum foil and placed in a ziploc bag
- Placed in MCB containing 3 ice bricks
- 5 Carcasses were placed in metal box and transferred to MELFI
- Notes: ice bricks are swapped out midday

RR1: Livers and Spleens were dissected on orbit

**Ice blocks to freeze the livers
(prechilled in Glacier)**

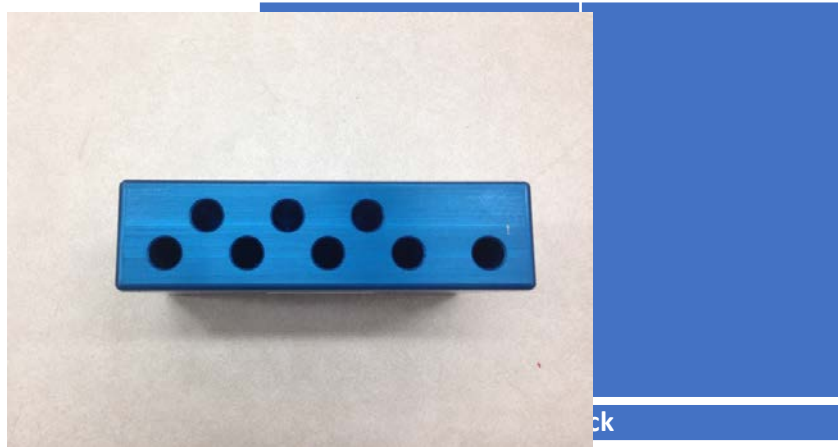

**Spleens preserved in RNAlater (4C for
24+ hours then stored in Melfi)**



RR1 samples were stored in MELFI until return to Earth on SpX5

On orbit: MELFI (-95°C)

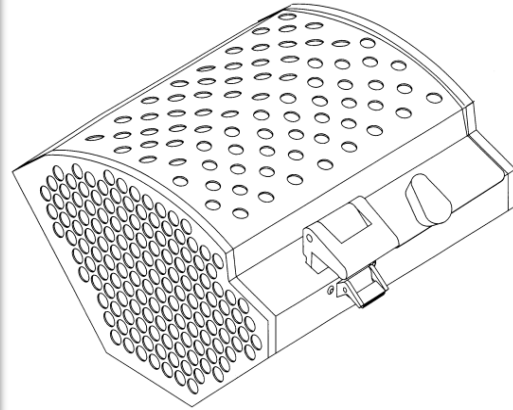

Ground: -80°C



Freezing Rates (RR1 vs. RR2-4)

RR1: MCB with 3 ice bricks

Sample	Mass	Time to Reach -20°C
Day 1 Sample 1	22.0g	31 min
Day 1 Sample 2	22.3g	37 min
Day 1 Sample 3	21.9g	52 min
Day 1 Sample 4	23.6g	71 min
Day 1 Sample 5	22.5g	83 min
Day 2 Sample 1	26.1	36.5 min
Day 2 Sample 2	21.9	32.5 min
Day 2 Sample 3	21.4	43 min
Day 2 Sample 4	23.2	57 min
Day 2 Sample 5	22.4	64.5 min

RR2-RR5: Direct MELFI insertion

Sample	Mass (g)	Time to Reach	Time to Reach
		-20°C (min)	-80°C (min)
Sample 1	33.6	38	101.5
Sample 2	28.14	38	106.5
Sample 3	26.97	41	87.5
Sample 4	25.33	37	175.5
Sample 5	29.9	40	142
Sample 6	30.61	43.5	108
Sample 7	26.5	39.5	88.5
Sample 8	24.1	37.5	77



RR-1 First Thaw BSP Dissection

- *Manuscript describing sample quality published:
 - Choi S, Ray HE, Lai SH, Alwood JS, Globus RK. Preservation of Multiple Mammalian Tissues to Maximize Science Return from Ground Based and Spaceflight Experiments. PLoS One. 2016 Dec 1;11(12):e0167391. doi: 10.1371/journal.pone.0167391.
- 32 different types of tissues were retrieved from 40 mice including 10 mice each from flight, ground controls, baseline and vivarium controls, yielding total of 3280 vials of tissues
- BSP tissues have been distributed to the scientific community through the Ames Life Science Data Archive (LSDA)
- Select samples were provided to Russian research colleagues at the Institute for Biomedical Problems (IBMP)
- NASA GeneLab project: Liver samples were provided for “omics” analyses (transcriptomics, epigenetics and proteomics)



Ames Life Science Data Archive



RR1 Validation results

RNA quality (RIN) RR1: validation samples

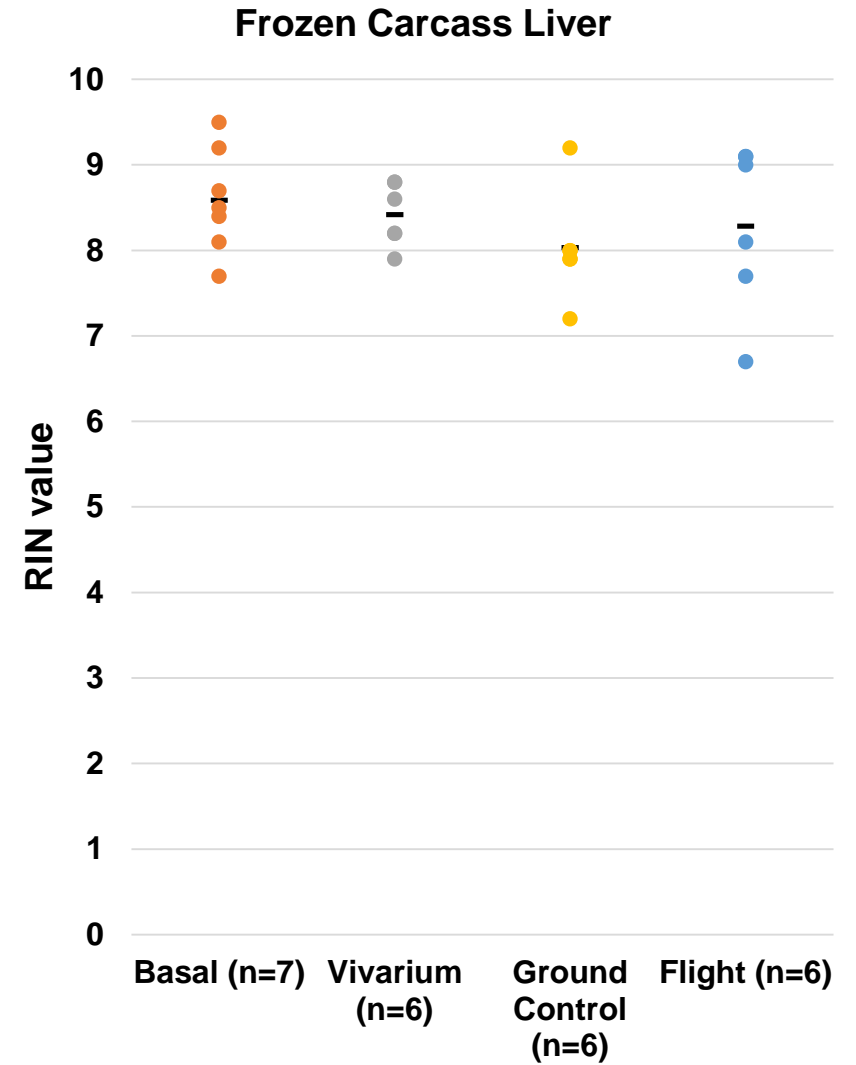
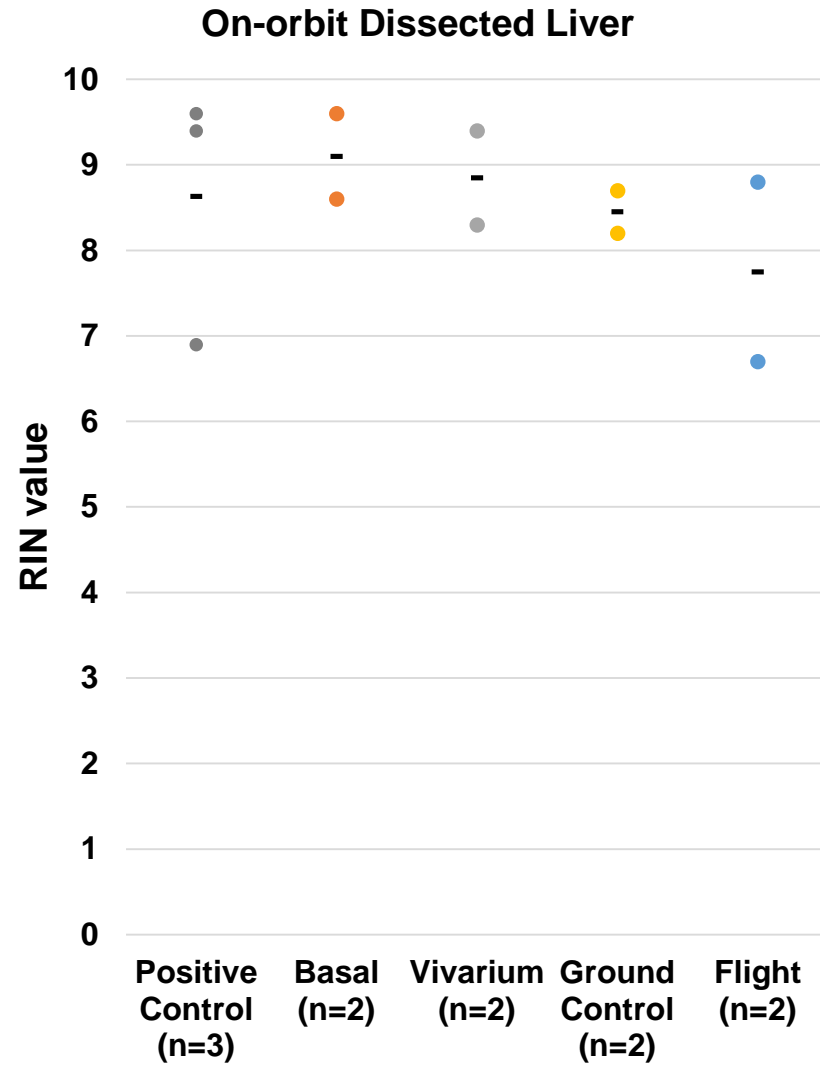

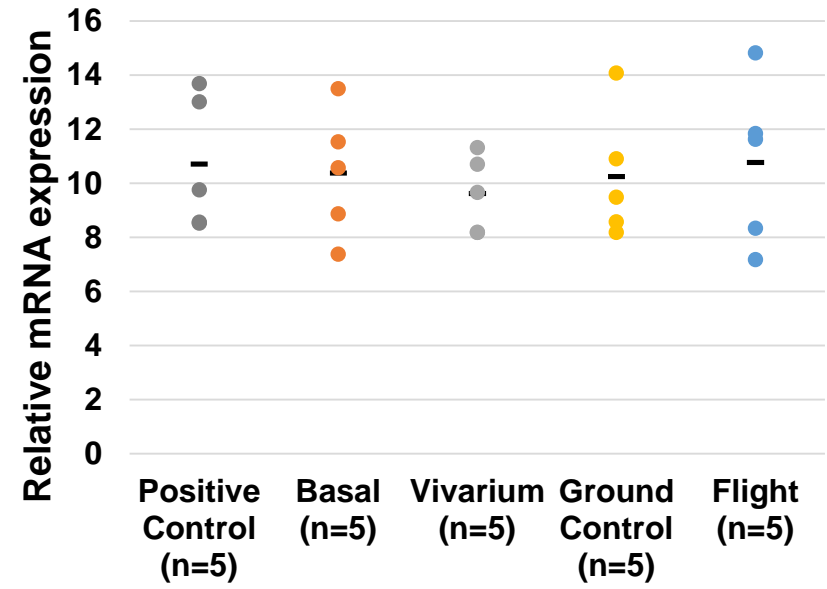
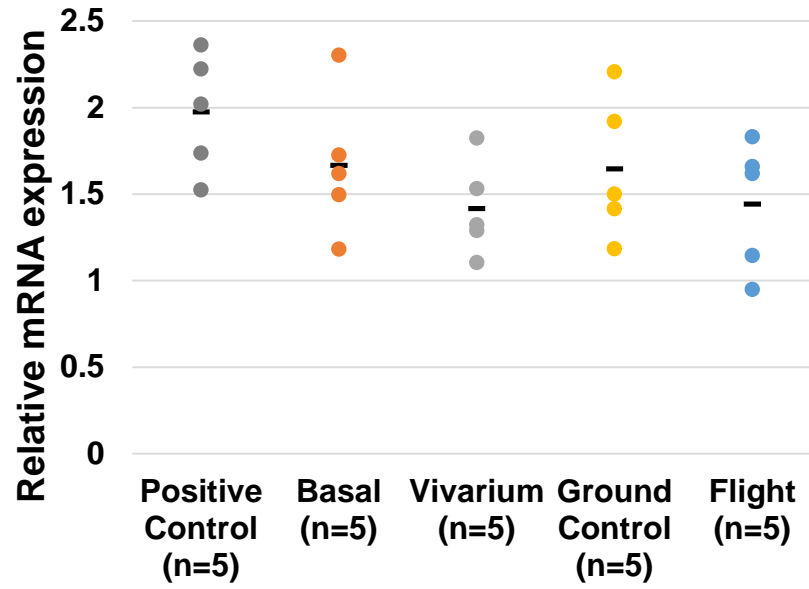
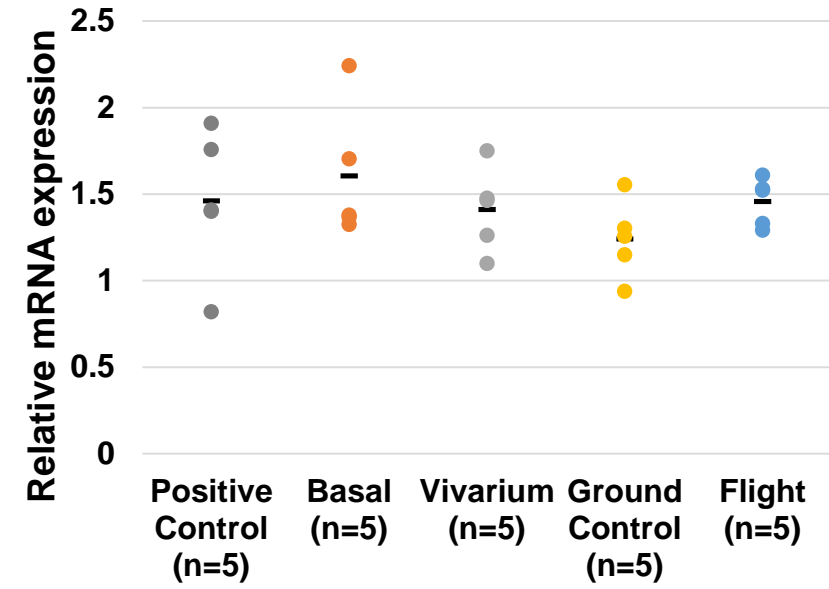
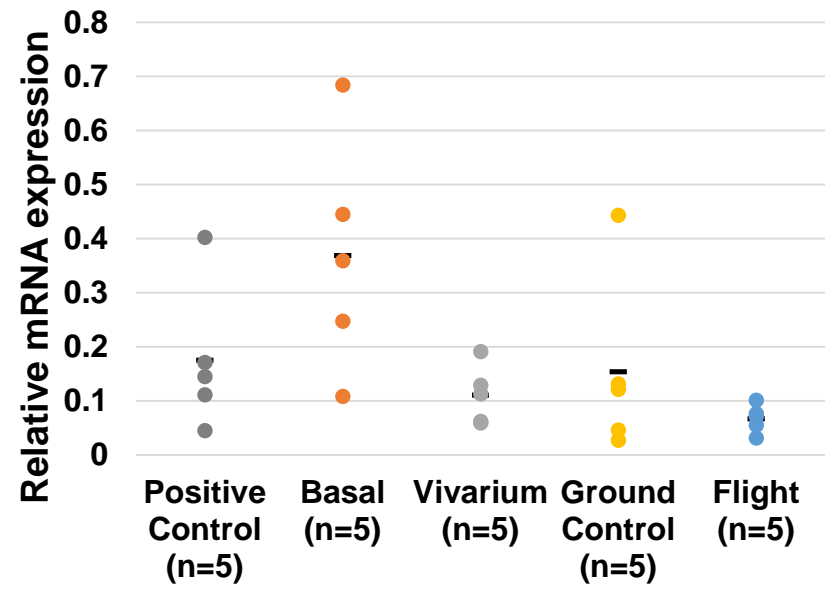
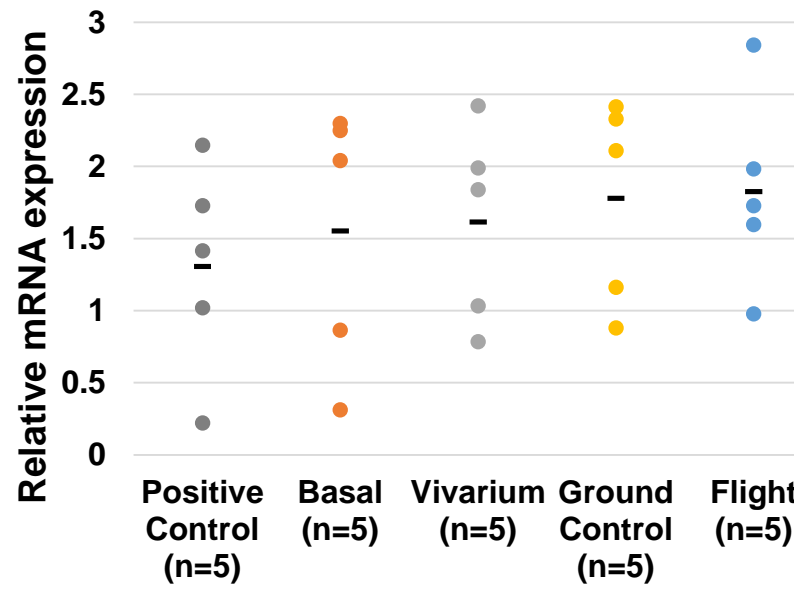
Albumin**Catalase****GAPDH****HMGCR****IGF1**

Normalized to L19 housekeeping gene.

Liver samples analyzed in triplicate.

Within group variability reflects animal-to-animal differences

RR1 Liver enzyme results from Validation and Experimental Mice

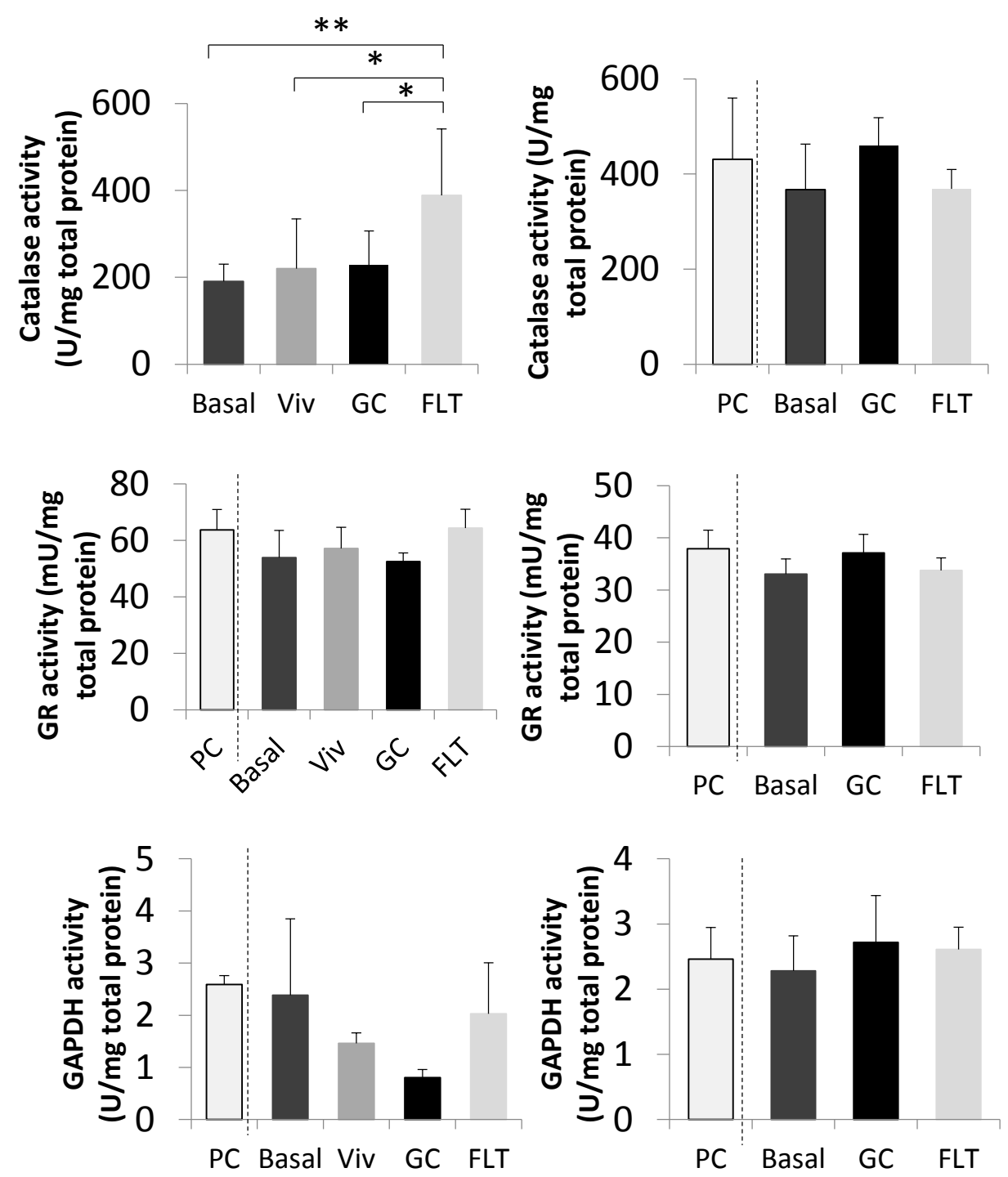

BSP PI SURVEY RESULTS

Tissue	Analysis	BSP dissection(s)	Tissue quality acceptable?	IS FCR acceptable as a process	Acceptable with improved sample processing?
Adipose	Histology	RR-1 rounds 1 and 2	Some, but not all	RR1 round 1: acceptable, RR1 round 2: not acceptable	Potentially
	qPCR	RR-1 rounds 1 and 2	Some, but not all	Acceptable	Yes
Blood vessel	Transcription profiling, protein expression profiling, histology, immunohistochemistry, Western blot, mechanical properties	RR-1 round 1, RR-3	Some, but not all	Acceptable	Yes
Bone	Histology, micro CT, qPCR	RR-1 round 1	Some, but not all	Acceptable only in cases where crew time for on orbit dissection is unavailable	Yes

BSP PI SURVEY RESULTS

Tissue	Analysis	BSP dissection(s)	Tissue quality acceptable?	IS FCR acceptable as a process	Acceptable with improved sample processing?
Feces	Microbiome analyses	RR-3	Some, but not all	Not acceptable	No
Gut	Transcription profiling, protein expression profiling, histology, immunohistochemistry, Western blot, mechanical properties	RR-3	Some, but not all	Not acceptable	Potentially
Liver	Histology, qPCR	RR-1 round 1	Some, but not all	Acceptable	Yes
Pancreas	Transcription profiling, protein expression profiling, histology, immunohistochemistry, Western blot, mechanical properties	RR-3	Some, but not all	Acceptable	Yes
Spleen	RNA-seq, ELISA	RR-1 round 1	Yes	Not acceptable	Potentially



Summary and Conclusion

- Select tissues can be utilized for gene expression, protein and histology studies, despite being retrieved from frozen carcasses
 - Further analysis needed
- These results expand potential science return from valuable and limited rodent experiments in space

Links/Resources

Recapturing a Future for Space Exploration: Life and Physical Sciences Research for a New Era
(National Research Council, 2011)

<http://www.nap.edu/catalog/13048/recapturing-a-future-for-space-exploration-life-and-physical-sciences>

CASIS/National Lab

<http://iss-casis.org/>

Space Biosciences Division-NASA Ames Research Center

<http://www.nasa.gov/ames/research/space-biosciences>

NASA Life Sciences Data Archive

<http://lsda.jsc.nasa.gov>

NASA's Genelab project

<http://genelab.nasa.gov>

Novartis: Mice in Space video, RR1 study

<https://www.youtube.com/watch?v=1L868FzjF2I>

The Health Risks of Extraterrestrial Environments (space radiation risk website)

<http://three.usra.edu/#section=main>

EXTRA



RR-1 First Thaw BSP Dissection

- *Manuscript describing sample quality published:
 - Choi S, Ray HE, Lai SH, Alwood JS, Globus RK. Preservation of Multiple Mammalian Tissues to Maximize Science Return from Ground Based and Spaceflight Experiments. PLoS One. 2016 Dec 1;11(12):e0167391. doi: 10.1371/journal.pone.0167391.
- 32 different types of tissues were retrieved from 40 mice including 10 mice each from flight, ground controls, baseline and vivarium controls, yielding total of 3280 vials of tissues
- BSP tissues have been distributed to the scientific community through the Ames Life Science Data Archive (LSDA)
- Select samples were provided to Russian research colleagues at the Institute for Biomedical Problems (IBMP)
- NASA GeneLab project: Liver samples were provided for “omics” analyses (transcriptomics, epigenetics and proteomics)



Ames Life Science Data Archive





Ground-Based Tissue Quality Test for the RR-1 **second thaw** dissection

- Objective:

- To assess if the tissues collected from the second thaw dissection are of high quality for analysis of gene expression

- Methods:

- Tissues were collected from frozen carcasses that were subjected to 2 cycles of freezing and thawing
- RIN (RNA integrity number) values of select tissues
- Additional 7 different types of tissues were retrieved from each of the 40 remaining carcasses.





Feedback from BSP PIs about the quality of tissues recovered from the second thaw

- Vaginal walls:
 - “The histology is fantastic - they look similar to freshly fixed tissue which is remarkable considering the vaginal walls were frozen, thawed, frozen again and then thawed before fixation” - Dr. Lane Christenson, University of Kansas Medical Center
- Brown adipose tissue:
 - “PCR array targeted for adipogenic genes were successfully performed using RNA samples isolated from brown adipose tissues”-Dr. Russell Turner, Oregon State University
- Aorta:
 - “RNA isolated from the second thaw aorta were not of high quality for RNA-seq but were suitable for microarray analysis using the FFPE (formalin-fixed, paraffin-embedded) method” -Dr. Sonja Schrepfer, UCSF



RR3 BSP dissection



- Over 25 types of tissues were retrieved from 30 non-treated mice (10 mice each from Basal, Ground controls and Flight) for NASA BSP and GeneLab
- ~1800 vials of tissues were transferred to Ames Life Science Data Archive for the scientific community (not including the tissues processed by the RR3 PIs and SLPS PIs)
- Tissues were snap frozen, preserved in RNAlater or fixed for histology.

Temperature profile: shipping from JSC to Ames

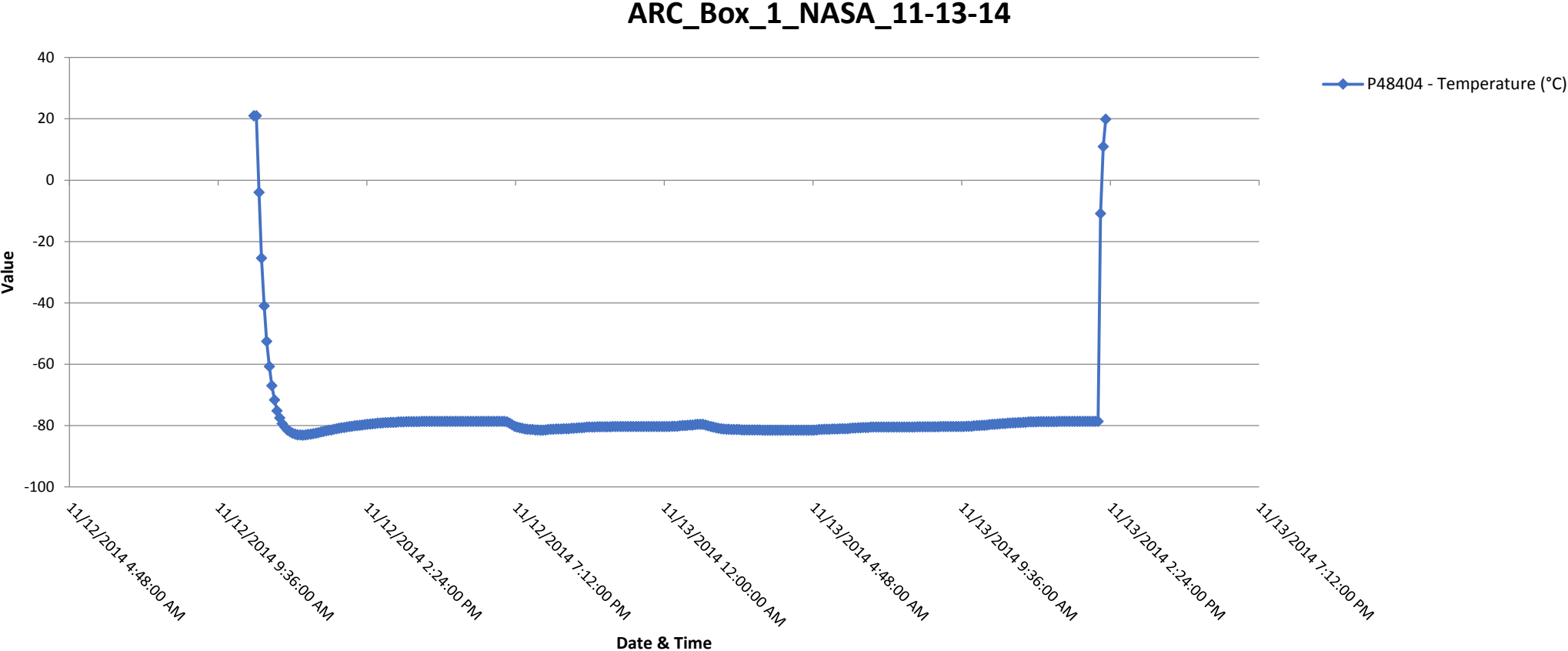

Temperature profile between MELFI insertion of samples and MELFI to Glacier transfer for return

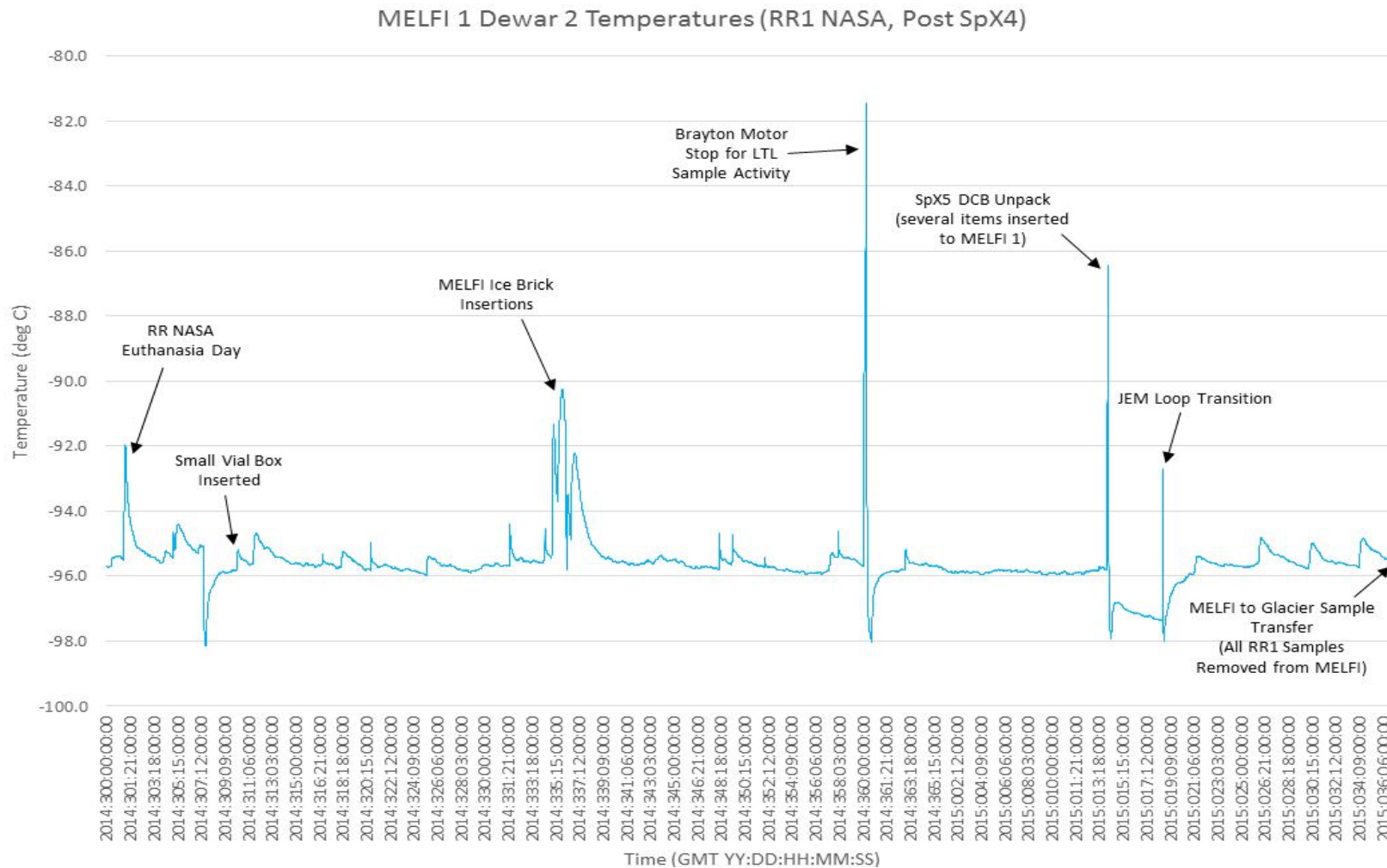

Temperature profile during return to Earth

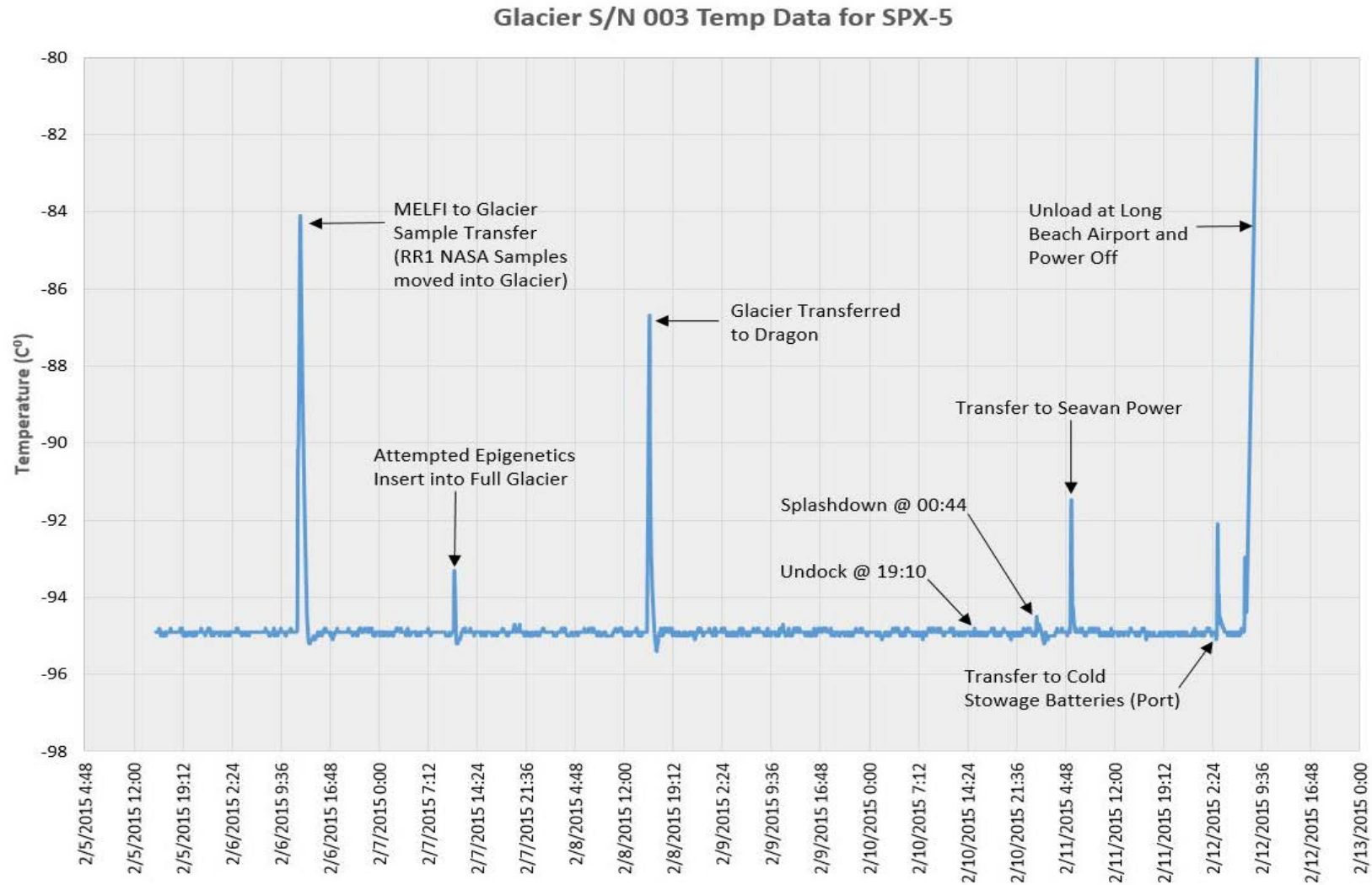

RR1: Tissue freezing rates using Cold block bricks in MCB

Sample	Mass (g)	Time to Reach -20°C (sec)	Time to Reach -80°C (sec)
Sample 1-1	2.91	100	225
Sample 1-2	3.05	110	180
Sample 1-3	2.97	150	290
Sample 1-4	3.14	130	285
Sample 1-5	2.88	145	395
Sample 1-6	1.88	150	255
Sample 1-7	1.84	150	290
Sample 1-8	1.72	140	400
Sample 2-1	3.07	105	240
Sample 2-2	3.04	120	210
Sample 2-3	3.11	130	260
Sample 2-4	3.1	145	580
Sample 2-5	3.04	140	410
Sample 2-6	1.81	150	280
Sample 2-7	1.98	155	315
Sample 2-8	1.6	170	640