

## IT'S A TRAP! A REVIEW OF MOMA AND OTHER ION TRAPS IN SPACE OR UNDER DEVELOPMENT

R. Arevalo Jr.<sup>1</sup>, W. B. Brinckerhoff<sup>1</sup>, P. R. Mahaffy<sup>1</sup>, F. H. W. van Amerom<sup>2</sup>, R. M. Danell<sup>3</sup>, V. T. Pinnick<sup>4</sup>, X. Li<sup>4</sup>, L. Hovmand<sup>5</sup>, S. A. Getty<sup>1</sup>, F. Goesmann<sup>6</sup>, H. Steingger<sup>6</sup>, and the MOMA Team<sup>1-6</sup>

<sup>1</sup>Planetary Environments Laboratory, NASA Goddard Space Flight Center, Greenbelt, MD, USA, ([Ricardo.D.Arevalo@nasa.gov](mailto:Ricardo.D.Arevalo@nasa.gov)), <sup>2</sup>MiniMass Consulting, Hyattsville, MD, USA, <sup>3</sup>Danell Consulting, Winterville, NC, USA, <sup>4</sup>CRESST, University of Baltimore, Baltimore, MD, USA, <sup>5</sup>Linear Labs, LLC, Washington, DC, USA, <sup>6</sup>Max Planck Institute for Solar System Research, Göttingen, Germany

**Introduction:** Since the Viking Program, quadrupole mass spectrometer (QMS) instruments have been used to explore a wide survey of planetary targets in our solar system, including (from the inner to outer reaches): Venus (Pioneer); our moon (LADEE); Mars (Viking, Phoenix, and Mars Science Laboratory); and, Saturn's largest moon Titan (Cassini-Huygens). More recently, however, ion trap mass spectrometer (ITMS) instruments have found a niche as smaller, versatile alternatives to traditional quadrupole mass analyzers, capable of in situ characterization of planetary environments and the search for organic matter. For example, whereas typical QMS systems are limited to a mass range up to 500 Da and normally require multiple RF frequencies and pressures of  $<10^{-6}$  mbar for optimal operation, ITMS instruments commonly reach upwards of 1000 Da or more on a single RF frequency, and function in higher pressure environments up to  $10^{-3}$  mbar.

**Rosetta (and Ptolemy):** The Rosetta spacecraft, built and launched on March 2<sup>nd</sup>, 2004 by the European Space Agency (ESA), features the Philae robotic lander, which is carrying onboard the first space-borne ITMS: Ptolemy. The Ptolemy instrument is a gas chromatograph mass spectrometer (GCMS) centered on a 3D ion trap (Fig. 1) developed by Open University, and with the primary objective of measuring stable isotopic ratios of light elements, including  $^2\text{H}/^1\text{H}$  (via  $\text{H}_2\text{O}$ ),  $^{13}\text{C}/^{12}\text{C}$ ,  $^{15}\text{N}/^{14}\text{N}$ ,  $^{17}\text{O}/^{16}\text{O}$ , and  $^{18}\text{O}/^{16}\text{O}$ . The Ptolemy ITMS offers a mass range of 12 – 150 Da, enabling complementary sample compositional analysis [1]. The operational protocol entitled MODULUS (Methods Of Determining and Understanding Light elements from Unequivocal Stable isotope compositions) allows determination of traditional stable isotopic ratios of gaseous species derived from direct sampling of the nucleus/coma, or by converting more refractory materials (polymeric organic compounds, dust etc.) to the requisite gas via thermal and/or chemical desorption processes [2]. Rosetta will perform a detailed study of the Jupiter-family comet 67P/Churyumov–Gerasimenko; the spacecraft arrived at the comet on August 6<sup>th</sup>, 2014

following a 10-year journey through the solar system. In November 2014, the Philae lander will be deployed to the surface, and the Ptolemy experiment, with the first spaceflight ITMS, will be activated [3].

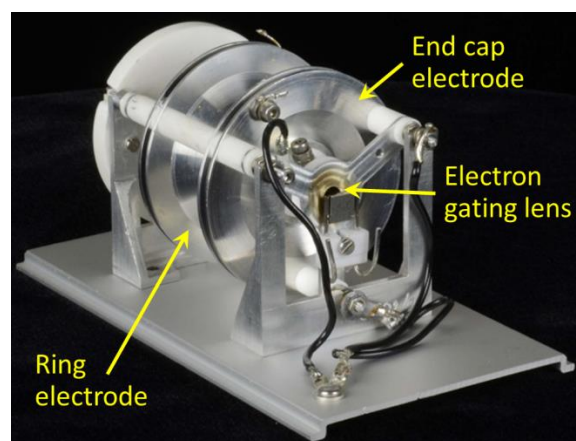

Fig. 1. Ptolemy 3D ion trap mass analyzer [4].

**ExoMars 2018 (and MOMA):** The 2018 mission of the ESA ExoMars Program, which follows the launch of the Trace Gas Orbiter and Entry, Descent and Landing Demonstrator Module (EDM) as parts of the 2016 mission, will deliver a European rover and a Russian surface platform to the surface of Mars [5]. The payload of the rover includes a suite of instruments ranging from panoramic and microscopic cameras to visible, infrared and Raman spectrometers to ground-penetrating radar. However, the largest instrument in the rover, and the core astrobiological experiment of the entire ExoMars Program, is the Mars Organic Molecule Analyzer (MOMA). The MOMA instrument represents an international collaboration between NASA and ESA (Fig. 2): the mass spectrometer subsystem is being developed, qualified and delivered by NASA GSFC; the solid-state ultraviolet (266 nm wavelength, 1 ns pulse width) laser system is supplied by Laser Zentrum Hannover e.V.; and the gas chromatograph (GC) is being provided by Laboratoire Inter-universitaire des Systèmes Atmosphériques (LISA). The Max Planck

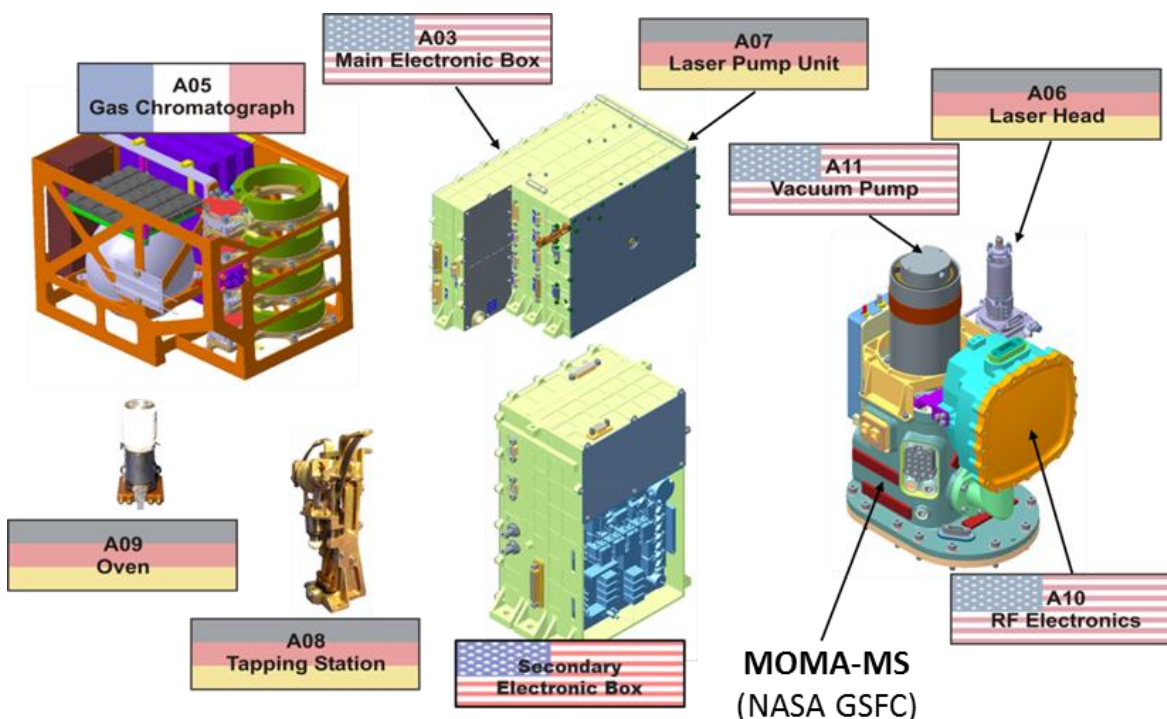

Fig. 2. Multinational contributions to the MOMA instrument. NASA GSFC is responsible for the development and delivery of the mass spectrometer subsystem, including the supporting radio frequency (RF), main and secondary electronics boxes (in collaboration with Battel Engineering and the University of Michigan), and wide-range pump (in collaboration with Creare, Inc.).

Institute for Solar System Research, the PI institution for the MOMA investigation, will provide the instrument's tapping station and pyrolysis ovens, and integrate and test them with the mass spectrometer, laser and GC subsystems.

The core of the MOMA instrument is a 2D (or "linear") ITMS; this geometry was selected in order to facilitate two symmetrical ion injection pathways into the trap, thereby enabling two independent modes of operation, namely laser desorption mass spectrometry (LDMS) at Mars ambient pressures, and traditional GCMS techniques. Moreover, the linear ITMS (Fig. 3) employed by MOMA offers a higher ion capacity compared to a 3D trap of the same volume, supports redundant detection subassemblies, and maintains a link to heritage QMS designs/assemblies. The MOMA ITMS enables the detection of organic molecules and inorganic compounds across a wide mass range, from 50 up to 1000 Da (though the MOMA breadboard instruments have been shown to detect ions >2000 Da), with unit mass resolution to 500 Da, and 2 Da resolution to 1000 Da.

The dual modes of operation enabled by MOMA represent an unprecedented ability to detect both volatile and refractory organic molecules, in addition to providing geochemical context through the measurement of inorganic signatures of sample mineralogy. In particular, the analysis of nonvolatile,

higher molecular weight organics (e.g., carboxylic acids, peptides, macromolecular carbon, etc.) even in the presence of significant perchlorate concentrations (up to wt.%-levels) has been demonstrated on both the breadboard instruments (e.g., [6]) and the engineering test unit (ETU). The MOMA ITMS is

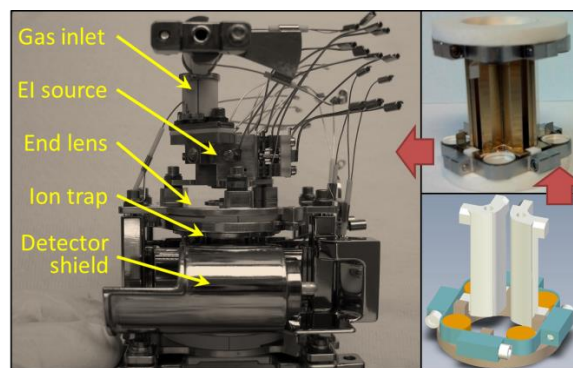

Fig. 3. (Counterclockwise from bottom right) 3D model of the MOMA linear ion trap; assembled breadboard trap; built MOMA ETU trap assembly.

capable of ion enhancement via stored waveform inverse Fourier transform (SWIFT), and deriving structural information from detected mass peaks through tandem mass spectrometry (or MS/MS), which have been demonstrated by the MOMA breadboards (e.g., [7]).

**Next Generation Traps:** Recently, significant resources have been invested to develop a series of even more capable ion traps for future spaceflight applications. As an example, an effort to develop an advanced linear ion trap mass spectrometer, or LITMS (Fig. 4), has been undertaken by a team at NASA GSFC and supported by the NASA ROSES MatISSE Program. This effort leverages the heritage mass spectrometer subsystem of MOMA, but looks to add the following analytical capabilities:

- Organic and inorganic analysis over an expanded mass range (i.e., 20 – 2000 Da);
- Detection of BOTH positive and negative ions (Fig. 4);
- Fine-scale (<1 mm) spatially resolved characterization of individual rock core layers via LDMS;
- Evolved gas analysis and GCMS of individual layer subsamples with pyrolysis up to 1300° C (enabling breakdown of refractory phases).

This progressive LITMS instrument delivers an unprecedented level of integrated analytical capability that is critically needed to achieve advanced astrobiology objectives, including the detection and identification of molecular organics, geochemical and stratigraphic characterization of preservational environments, and thus measurements of habitability of planetary environments.

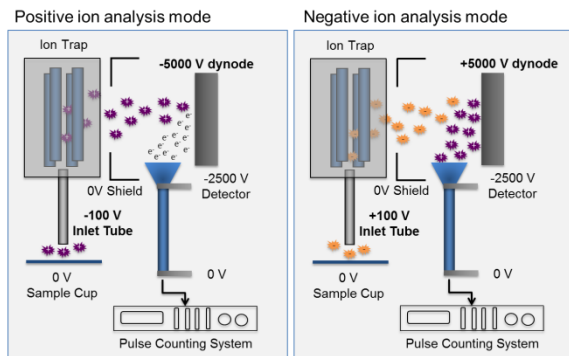

Fig. 4. The LITMS instrument enables both positive and negative ion detection by employing a discrete dynode with dual polarity.

The Jet Propulsion Laboratory (JPL) has also been developing an innovative ion trap technology, specifically the Mass Analyzer for Real-time Investigation of Neutrals at Europa (MARINE). The MARINE instrument (Fig. 5), which relies on a 3D ion trap mass analyzer, promises to be a low mass, low power mass spectrometer that supports ultra-high sensitivity and precision measurements of gases and other volatile molecules. The primary goals of MARINE are to measure the abundances of neutral gases in Europa's exosphere (e.g., H<sub>2</sub>O, O<sub>2</sub>, CO<sub>2</sub>, and

SO<sub>2</sub>), but also determine their number density profiles as a function of altitude [8]. Although MARINE is a relatively new instrument concept, the 3D trap itself has been under development and test at JPL for over a decade, culminating in the flight and operation of the trap-based Vehicle Cabin Atmosphere Monitor (VCAM) instrument on the International Space Station; VCAM successfully measured gas species down to parts-per-billion levels in order to monitor the air quality of a crewed vehicle during mission operations (June 2010 – June 2012; [9]).

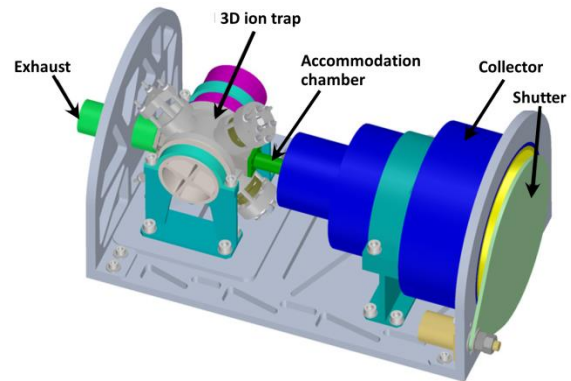

Fig. 5. The MARINE instrument, which can be mounted on a spacecraft boom, uses a collector to funnel neutrals into a high-sensitivity 3D ion trap. (image modified from [8]).

Another new frontier in the development of ion traps capable of planetary exploration is the evolution of a high-resolution (up to  $m/\Delta m = 10^5$ ; full width at half maximum, or FWHM) Orbitrap mass analyzer for spaceflight, as demonstrated by the French Orbitrap Consortium, consisting of: LPC2E, Orléans; LISA, Créteil; LATMOS, Guyancourt; IPAG, Grenoble; and, CSNSM, Orsay. The Orbitrap was

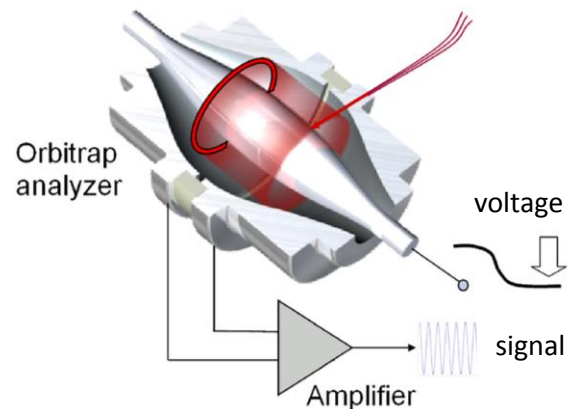

Fig. 6. Architecture of an Orbitrap analyzer (Source: [10]). Copyright 2012 Thermo Fisher Scientific.



designed/patented originally by Alexander Makarov and commercialized by Thermo Fisher Scientific; the device itself consists of axially-symmetrical outer barrel and central spindle electrodes (Fig. 6). Although the Orbitrap requires high vacuum (i.e.,  $<10^{-8}$  mbar) to achieve maximum mass resolution, the quadrolarithmic electrostatic potentials employed by this analyzer negate the need for magnetic or RF fields and associated electronics.

The French Orbitrap Consortium has interfaced successfully an ultraviolet (337 nm) laser source with an Orbitrap mass analyzer repackaged for future spaceflight consideration. This team has derived mass spectra of irradiated solid samples, such as zirconium (Fig. 7), and demonstrated the capacity of the instrument to achieve ultra-high mass resolution. Flagged by ESA as an instrument concept of interest for the 2012 Marco Polo(-R) mission, this effort has been executed as a Research and Development (R&D) program, partly funded by the French Space Agency (CNES), and in collaboration with Thermo Fisher Scientific [11].

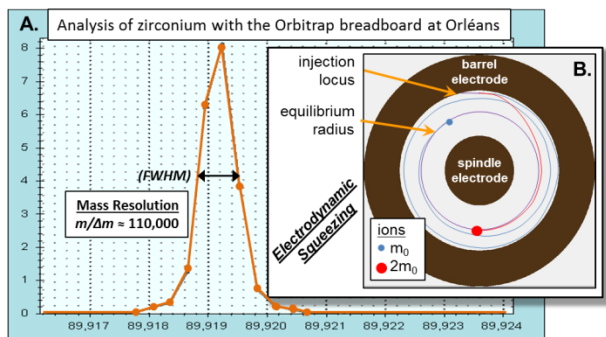

Fig. 7. Mass spectrum derived from the analysis of zirconium measured via LDMS methods with the breadboard Orbitrap at LPC2E (Orléans). A mass resolving power of  $m/\Delta m > 10^5$  (FWHM) is observed under vacuum conditions ( $<10^{-8}$  mbar; [12]).

## References:

- [1] March and Todd, 2005. *Quadrupole Ion Trap Mass Spectrometry, 2<sup>nd</sup> Edition*, John Wiley & Sons, Inc., Hoboken, NJ, 291 – 307.
- [2] Wright et al., 2007. *Space Science Reviews (128)*, 363 – 381.
- [3] <http://sci.esa.int/rosetta>, ESA.
- [4] <http://open.ac.uk>, Open University.
- [5] <http://exploration.esa.int/mars>, ESA.
- [6] Li et al., 2014 (submitted). *Astrobiology*.
- [7] Danell et al., 2014. *62<sup>nd</sup> ASMS Conference*, Baltimore, MD, USA.
- [8] JPL, 2013. Instruments Division Annual Report. [http://instrument.jpl.nasa.gov/docs/319\\_ANNUAL\\_REPORT\\_FY\\_2013\\_INSTRUMENTS\\_DIVISION\\_Final.pdf](http://instrument.jpl.nasa.gov/docs/319_ANNUAL_REPORT_FY_2013_INSTRUMENTS_DIVISION_Final.pdf)
- [9] Darrach et al., 2012. *42<sup>nd</sup> International Conference on Environmental Systems*, San Diego, CA, USA.
- [10] Zubarev and Makarov, 2013. *Analytical Chemistry (85)*, 5288-96
- [11] Briois et al., 2014. *Asteroids, Comets, Meteors Conference*, Helsinki, Finland.
- [12] Aradj et al., 2013. [http://www.esep.pro/sites/esep/IMG/pdf/poster\\_orbitrap\\_lpc2e.pdf](http://www.esep.pro/sites/esep/IMG/pdf/poster_orbitrap_lpc2e.pdf)