

FPMU (Floating Potential Measurement Unit)

# Spacecraft Charging

Hazard Causes

Hazard Effects

Hazard Controls

***ES4/Dr. Steve Koontz, ISS System Manager for Space Environments***

NASA Johnson Space Center, 2101 NASA Parkway, Houston, Texas, 77058, USA, 281-483-8860

Email: [steven.l.koontz@nasa.gov](mailto:steven.l.koontz@nasa.gov)





# Executive Summary

- **Hazard Cause - Accumulation of electrical charge on spacecraft and spacecraft components produced by:**
  - Spacecraft interactions with space plasmas, energetic particle streams, and solar UV photons (free electrons and photons typically drive these processes)
  - Spacecraft electrical power and propulsion system operations
- **Hazard Effects**
  - **Electrical discharges leading to:**
    - Radiated and conducted “static” noise in spacecraft avionics systems
    - Failure of spacecraft electrical power system components
    - Failure of spacecraft avionics (C&DH, C&T, GN&C) hardware
    - “Static” noise and possible hardware damage on docking of two spacecraft at very different electrical potentials (first contact bleed resistors don't always work here...)
- **Hazard Controls**
  - “Safe and verified design” – follow NASA and DoD standards and guidelines
    - Materials selection, grounding, bonding, and EMI/EMC compatibility, and screen for/eliminate potentially hazardous configurations, **verified during acceptance testing (not everyone knows what the requirement means)**
  - Active charging controls (e.g., plasma contactor units or something like that)
  - In-flight operational hazard controls (if all else fails and assuming there are any)
  - **“Test like you fly and fly like you test” (to the extent possible)**



# Presentation Outline

- **Spacecraft Charging Environments and Processes: Summary and General Principles**
  - ◆ **Why do we care about this?**
  - ◆ Spacecraft charging summary
  - ◆ A simple, basic spacecraft charging/discharging circuit
  - ◆ Spacecraft materials, configuration, and operations effects
  - ◆ Internal vs. external charging
  - ◆ The charge balance equation
- **Some Important Spacecraft Charging Environments and Processes**
  - ◆ Space Plasmas and Energetic Particles – The Numbers
  - ◆ Simple worked examples and spacecraft flight data
    - ◆ LEO/ISS - Cold/high density plasma and geomagnetic field - ISS PV Array and Motional EMF - structure charging
    - ◆ Auroral Electron Charging in LEO and low (<1000 km) Polar Orbit – surface and structure charging
    - ◆ GEO Charging - Hot/low density plasma – surface and internal charging
  - ◆ Cis Lunar and Interplanetary Charging Environments - Solar Wind and SPE
    - ◆ Hot/low density plasma and energetic particles
- **Space Weather and Charging Environment Variability**
  - ◆ Ionosphere, Aurora, and GEO/Interplanetary
- **So what do I do about all this and what happens if I don't?**
- **Backup and References**

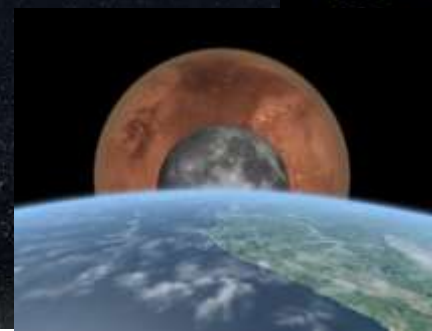

# **Spacecraft Charging Environments and Processes: Summary and General Principles**



# Spacecraft Charging Environments and Processes: General Principles

## Why do we care about this?

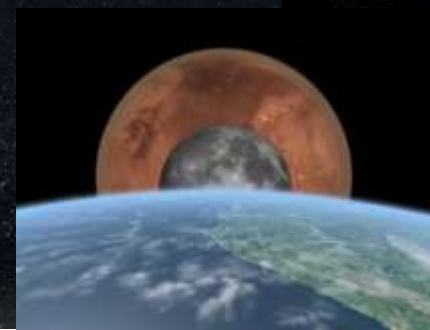

- **Safety, Reliability, and Mission Success**
- If not accounted for during spacecraft design development and test:
  - ◆ You may get lucky and operate successfully via workarounds
  - ◆ Or you may fail to achieve mission objectives, operational reliability requirements, or in extreme cases, loose the entire spacecraft (e.g., ADEOS-II and DSCS-9431)
- The most common **hazard effects** of the spacecraft charging **hazard cause** are:
  - ◆ Avionics system failures and anomalies
  - ◆ Electrical power system failures and anomalies
  - ◆ Surface performance property degradation caused by arcing
  - ◆ Increased attitude control propellant use rates (energetic surface arcing can be propulsive)

Table 1. Distribution of Records by Anomaly Diagnosis

Diagnosis	Number of Records
ESD—Internal Charging	74
ESD—Surface Charging	59
ESD—Uncategorized	28
Single-Event Effects	85
Damage	16
Micrometeoroid/Debris Impact	10
Miscellaneous	26

Aerospace Corp. Report TR-2000(8570)-2; 28 February, 2001

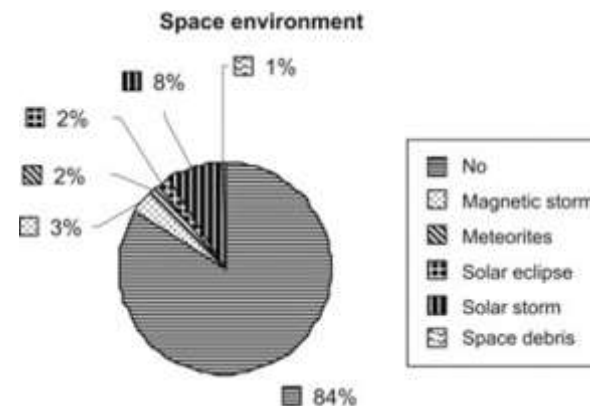

Mak Tafazoli; "A study of on-orbit spacecraft failures,"  
Acta Astronautica, Volume 64, Issues 2–3, 2009, 195–205  
See back-up for more on this)



# Spacecraft Charging Environments and Processes: Spacecraft Charging Summary

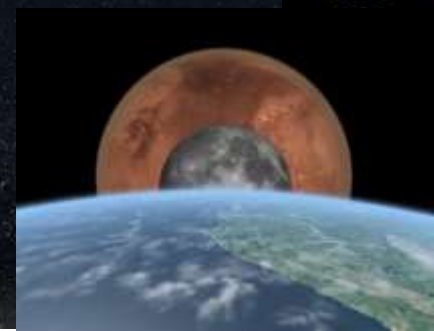

- **Spacecraft Charging:**
  - ◆ Processes that produce an electrical potential or voltage difference between the spacecraft and the surrounding space plasma environment (**absolute charging**) and/or voltage differences between electrically isolated parts of the spacecraft (**differential charging**)
- Electrical potential differences result from the separation of positive and negative charges, in the spacecraft, in the flight environment, or both with accumulation of an excess of one charge on the spacecraft or spacecraft components.
  - ◆ **Current balance equations** that account for the ion and electron currents to and from the spacecraft
  - ◆ **Determining factors** - The flux and kinetic energy of high-energy charged particles, local space plasma density and temperature, spacecraft motion relative to the local space plasma and magnetic field, as well as spacecraft systems operating voltages and currents can all affect the spacecraft charging current balance.
- During charging and discharging, electrical currents will flow through or onto various parts of the spacecraft, and those currents can be damaging.
  - ◆ Simple resistor/capacitor charging circuits can give you a feel for how this works
  - ◆ **Conductors and dielectrics charge and discharge in very different ways**

# Spacecraft Charging Environments and Processes: Summary

## A very simple, basic, spacecraft charging/discharging circuit

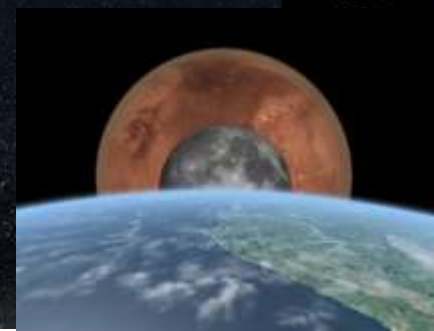

- Spacecraft charging isn't magical
  - Electricity and magnetism along with some gas kinetics and plasma physics
- It appears magical at first because the circuit elements are exotic compared to what we encounter in the electronics lab – **for example**
  - $V$  isn't always a simple power supply voltage – depends on charged particle kinetic energy and vehicle electrical potential among other things
  - $R_1$  depends on vehicle current collecting area and plasma density
  - $R_2$  can depend on a variety of things like dielectric breakdown arc plasma density and active vehicle charging control equipment
  - $C$  depends on vehicle configuration and plasma density among other things

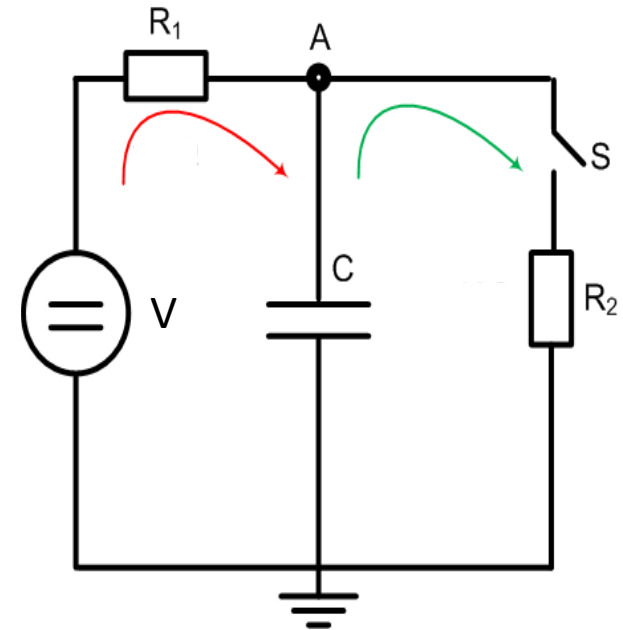

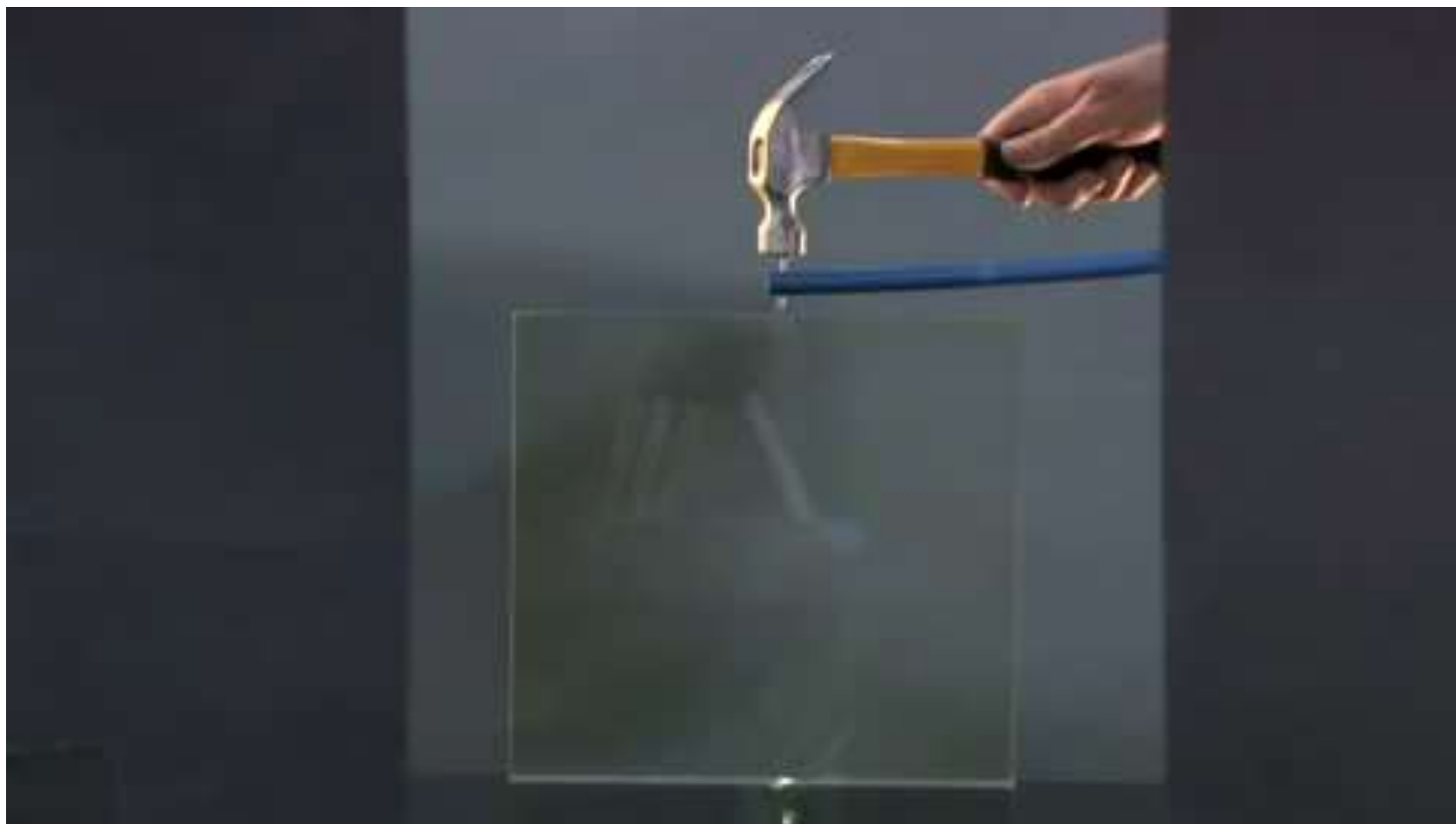
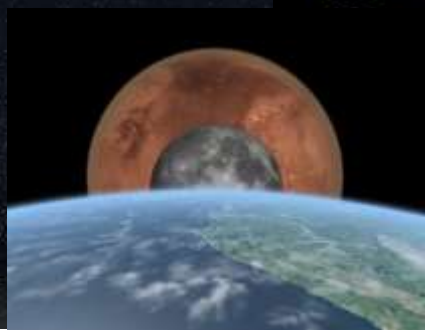





# Spacecraft Charging Environments and Processes: Summary

Spacecraft mission environment,  
materials, configuration, con-ops

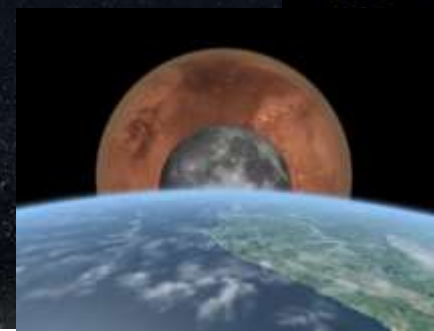

- **Spacecraft mission environments and velocity with respect to plasma or local magnetic fields**
  - ◆ Flight environment and mission timeline determine charging processes
- **Spacecraft current and voltage sources interacting with the local environment**
  - ◆ Can drive current collection to and from space plasma environment
- **Area of spacecraft metallic material exposed to energetic charged particle flux or ambient plasma**
  - ◆ Current collection into spacecraft circuitry and conducting structure
- **Electrical properties of spacecraft materials**
  - ◆ Secondary and photoelectron emission characteristics of the spacecraft materials
  - ◆ Dielectric materials conductivity
  - ◆ Dielectric material relaxation time
  - ◆ Dielectric breakdown voltage
  - ◆ Are dielectrics static dissipative?



# Spacecraft Charging Environments and Processes: Summary

Spacecraft mission environment,  
materials, configuration, con-ops

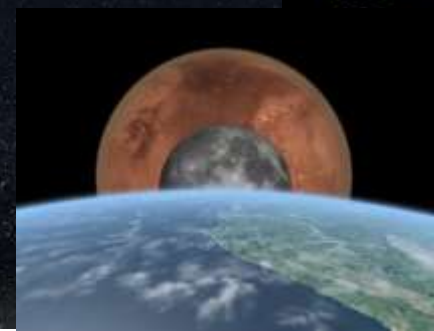

## ● Spacecraft capacitance and capacitance of electrically isolated spacecraft components

◆  $C = Q/V$  so  $V = Q/C$ ; also stored energy available to cause problems;  $E = \frac{1}{2} CV^2$

✦  $C = 111.26501(R)$  pF sphere

✦  $C = 70.83350(R)$  pF disk

✦  $C = 111.26501(\pi R^2/d)$  pF coated sphere

✦  $C = 70.83350(\pi R^2/d)$  pF coated disk

✦ V in Volts, Q in Coulombs, R and d in meters

✦ Note that capacitance is defined for conductors but using the equations as an estimate for dielectrics is a common practice

✦ Note also that the plasma sheath around the spacecraft can and does contribute to net capacitance

● It should be clear that any object with a dielectric film thickness,  $d$ , on the order of  $10 \mu$  and an area,  $\pi R^2$ , on the order of  $1 \text{ m}^2$ , will have a parallel plate capacitance that is  $10^4$  times larger than the free-space capacitance and

● Big capacitors require more charging current and time ( $Q = i \times t$ ) than small capacitors

# Spacecraft Charging Environments and Processes: General Principles.

## Internal vs. Surface Charging

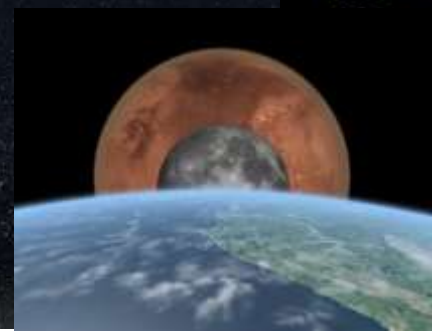

- Electron kinetic energy is of primary importance here (protons are less important)
- Surface charging: 0 to 50 keV
- Surface to internal charging transition: 50 to 100 keV
- Internal charging  $> 100\text{keV}$
- Practical range of concern for GEO/cis-Lunar orbits:
  - 0.1 to 3 MeV assuming  $\sim 0.08$  to 0.3 cm Al shielding
- Grounded conducting structure can also be a charging target and spacecraft electrical systems operations can be a charging cause

# Spacecraft Charging Environments and Processes: General Principles.

## Internal vs. Surface Charging

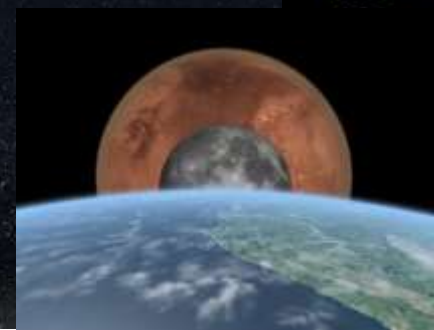

Garrett, H. B., Whittlesey, A. C.; GUIDE TO MITIGATING SPACECRAFT CHARGING EFFECTS, John Wiley & Sons, Inc., Hoboken, New Jersey, 2012

Charged particle range in Al vs. particle kinetic energy in MeV

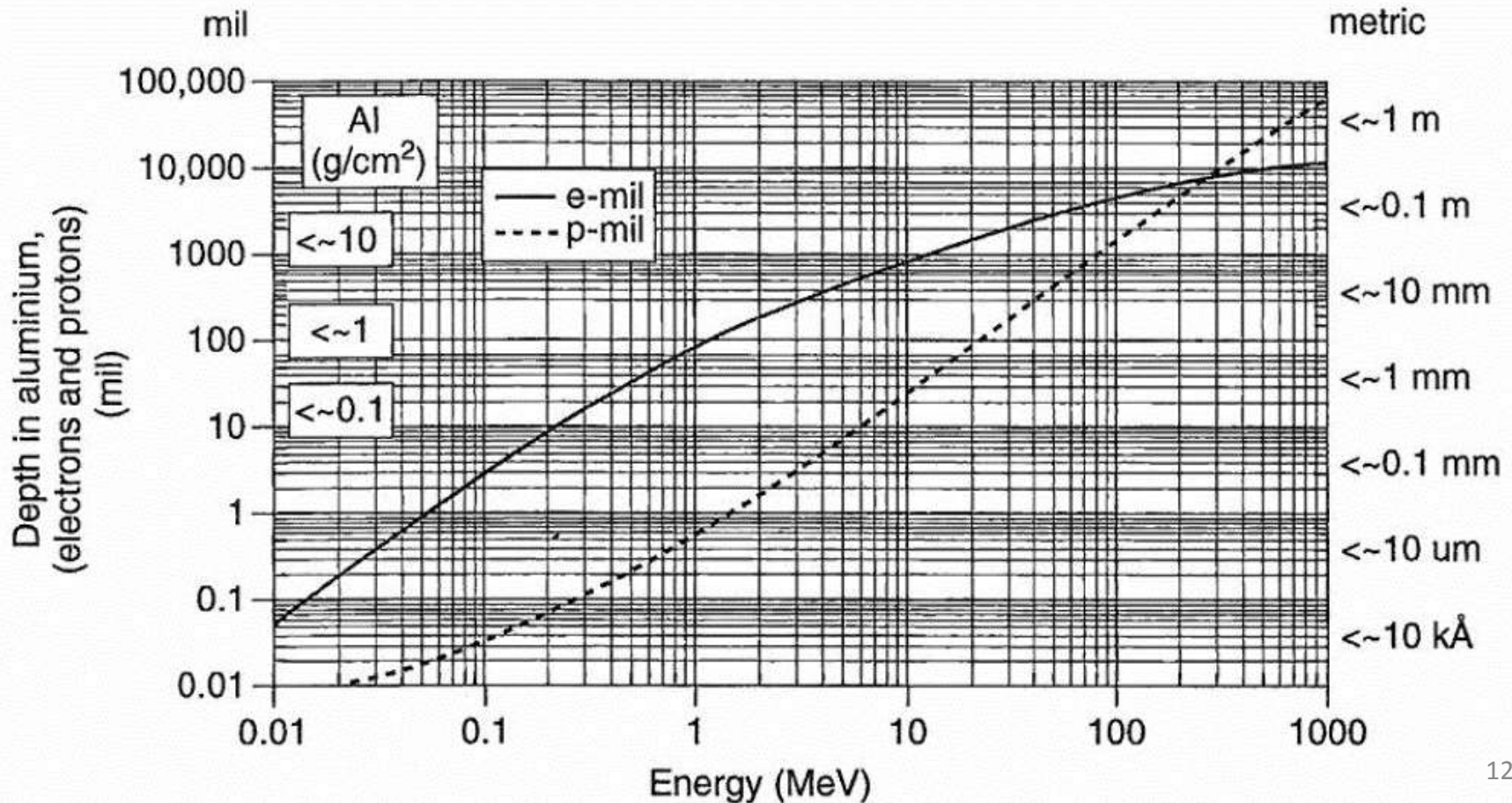

# Spacecraft Charging Environments and Processes: General Principles.

## Internal vs. Surface Charging

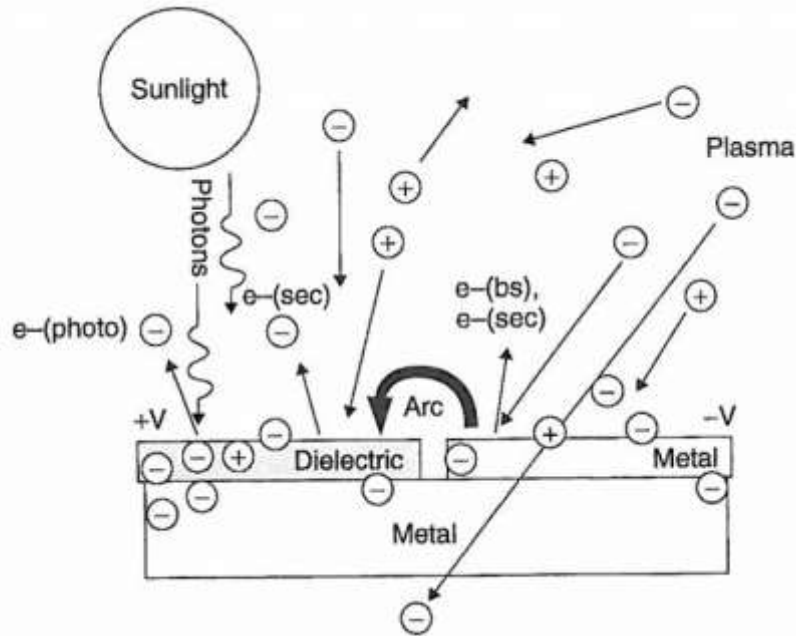
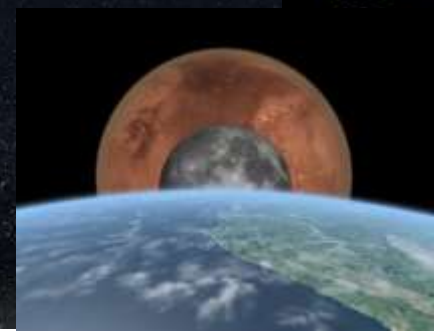

Surface charging/discharging

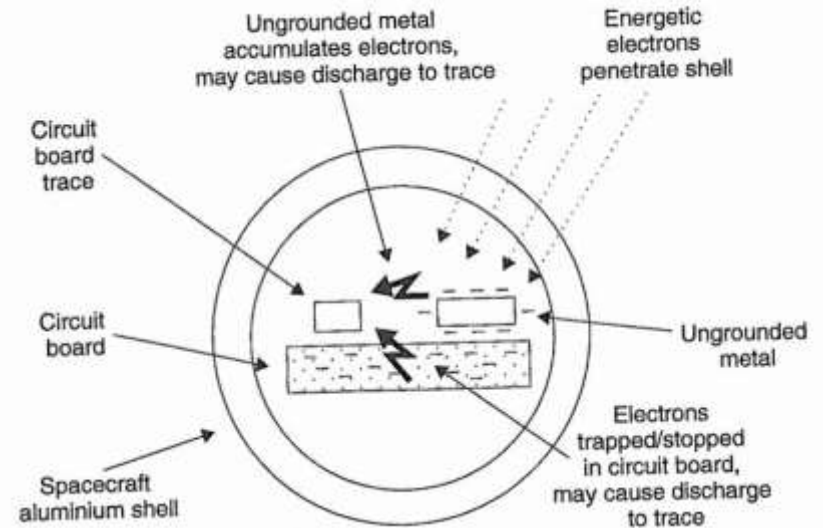

Internal charging/discharging

# Spacecraft Charging Environments and Processes: Summary

## Metal structure with thin dielectric coating – ISS MM/OD shields



- 1) Active electron (-) collection by ISS PV arrays **drives ISS conducting structure to negative FP**
- 2) Ionospheric ions (+) attracted to negative structure and produce positive charge on thin dielectric (anodized Al) surface coatings
- 3) Dielectric breakdown arc plasma provide conductive path for capacitor discharge and degrades PTCS on MM/OD shields with both conducted and radiated EMI

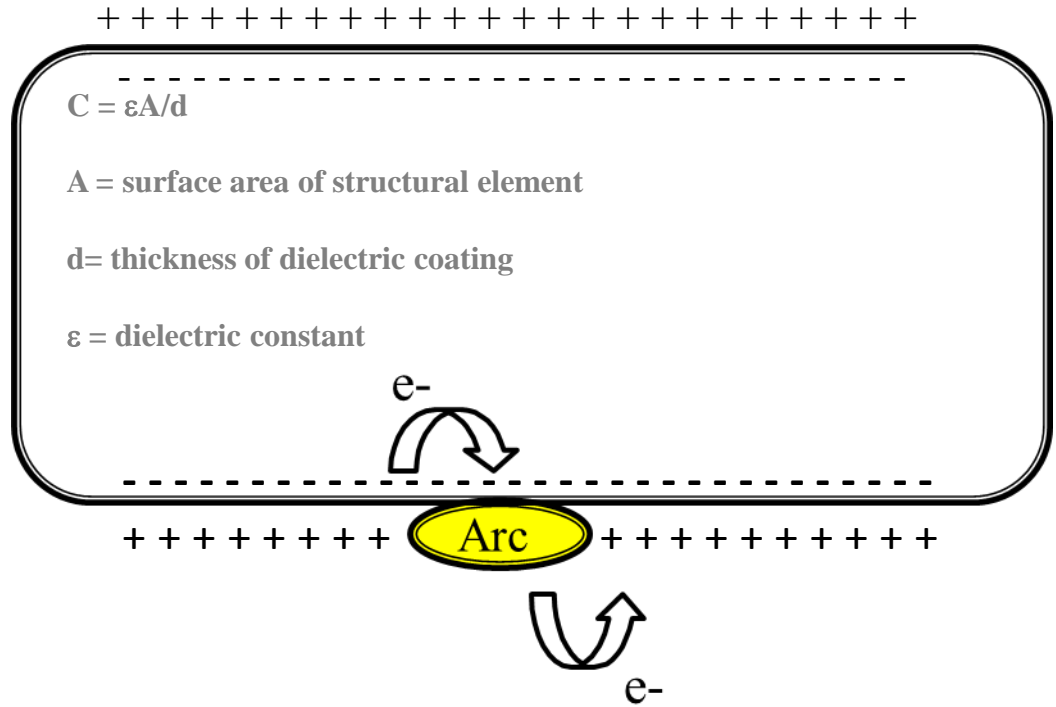

# Spacecraft Charging Environments and Processes: Summary

## Dielectric breakdown in LEO



Arc damage in laboratory tests of the chromic acid anodized thermal control coating covering ISS orbital debris shields.  
Credits: NASA/T. Schneider

ESA EURECA satellite solar array sustained arc damage.  
Credits ESA

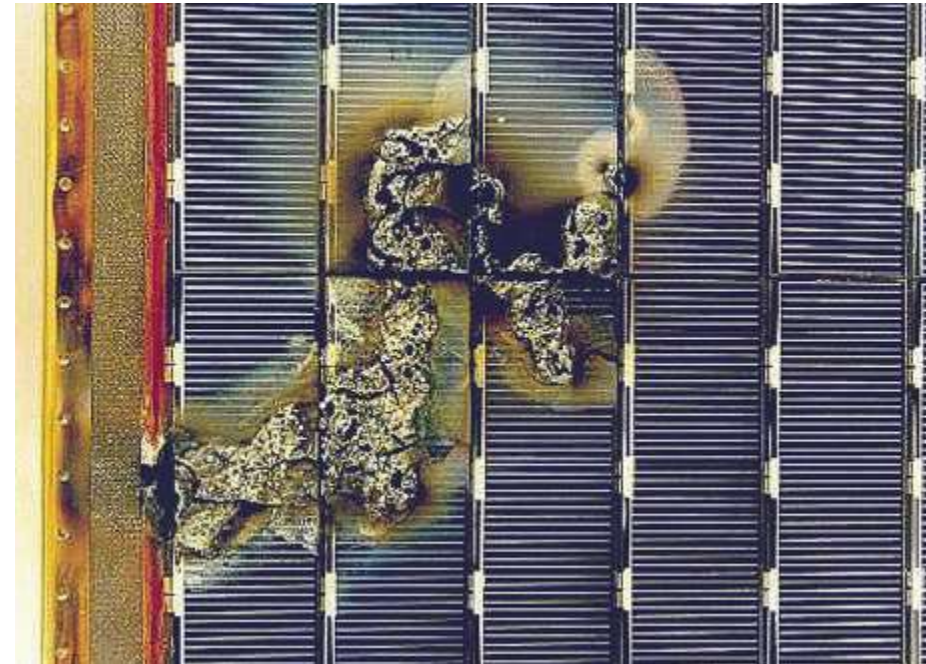

<https://www.nasa.gov/offices/nesc/articles/understanding-the-potential-dangers-of-spacecraft-charging>



# The Charge Balance Equation

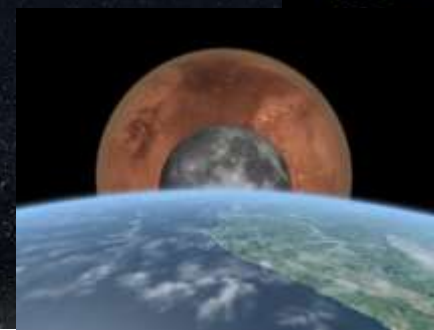

$$I_e(V) - [I_i(V) + I_{ph}(V) \pm I_{other}(V)] = I_{total}(V)$$

$V$  = Spacecraft Floating Potential (FP) - voltage relative to the local space plasma

$I_e$  = electron current incident on spacecraft surface(s)

$I_i$  = ion current incident on spacecraft surface(s)

$I(\text{other})$  = additional electron current from secondaries, backscatter, satellite hardware sources (electron guns, ion engines, plasma contactors, PV array collection, etc.)

- $I_{ph}$  = photoelectron current from spacecraft surfaces in sunlight, typically on the order of  $10^{-9}$  amps/cm<sup>2</sup> at Earth orbit and decreases as distance from the sun increases ( $1/R^2$ )
  - Only applies to surface charging – no effect on deep dielectric/internal charging
- If  $I_{ph} > I_e$ , spacecraft surface will charge positive.

$I_{total}$  = total current to spacecraft:  $I_{total} = 0$  (at equilibrium)

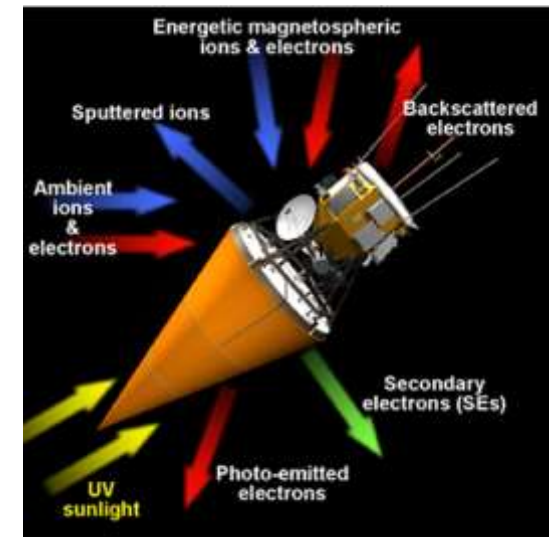



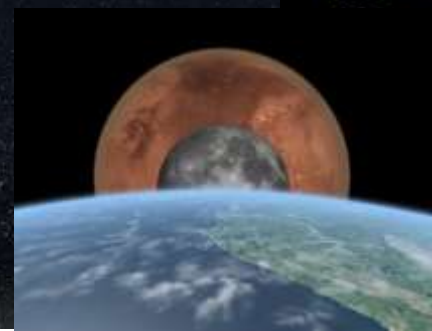

# Some Important Spacecraft Charging Environments and Processes

# Spacecraft Charging Environments: LEO Ionosphere

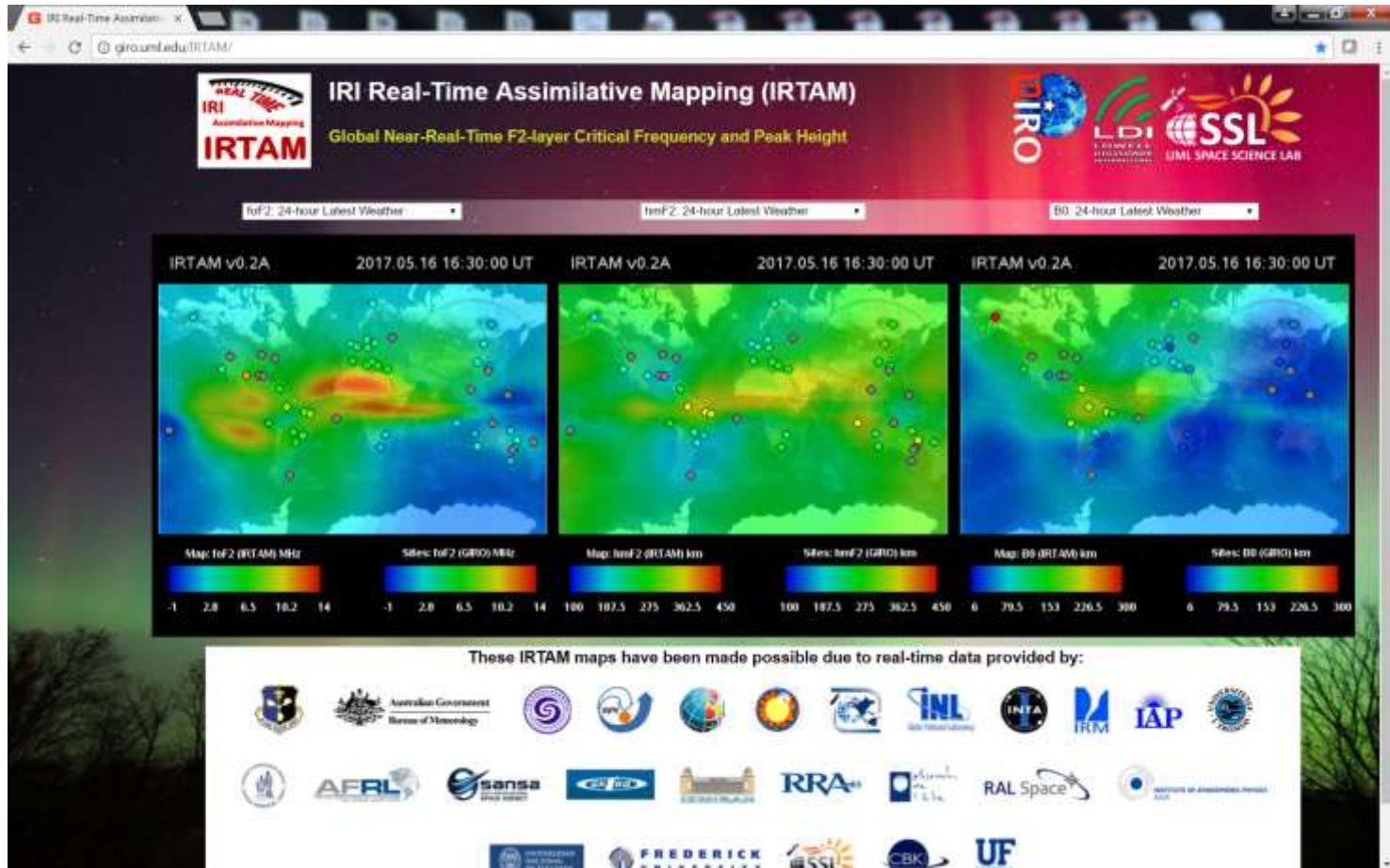

<http://giro.uml.edu/IRTAM/>

# LEO: Ionospheric Plasma and Geomagnetic Field Charging Environments

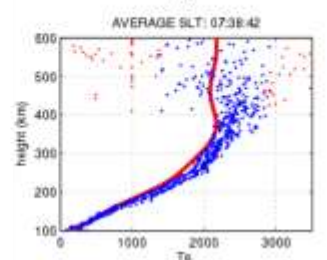
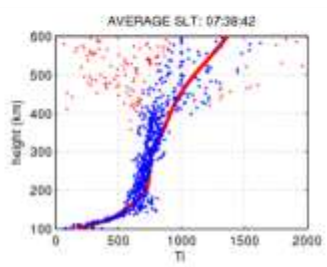
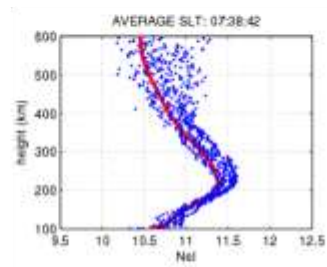
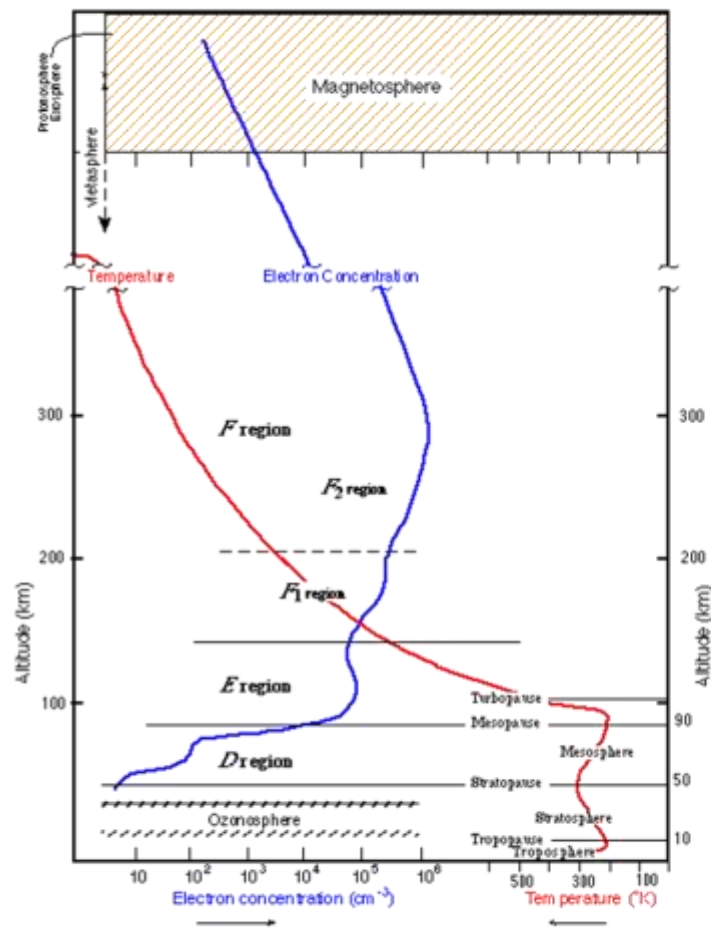
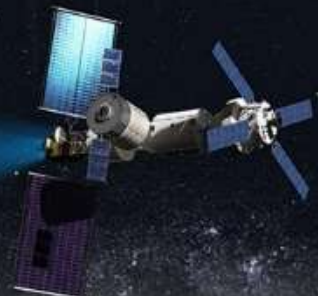

**ISR Data and Model for Millstone Hill in the last 1 hour (A/C)**  
(red for SNR < 0.15 & 35% of model)

F107 = 74  
 ap = 4  
 Current Local Time 30-Sep-2005 09:09:17

# Spacecraft Charging Environments: Magnetosphere and GEO

Some important GEO and magnetospheric environment charging data spacecraft: ATS-5, ATS-6, SCATHA, CRRES, ISEE Geotail, Lunar Prospector, Themis/Atremis, Van Allen Probes, and many listed in the graphics below

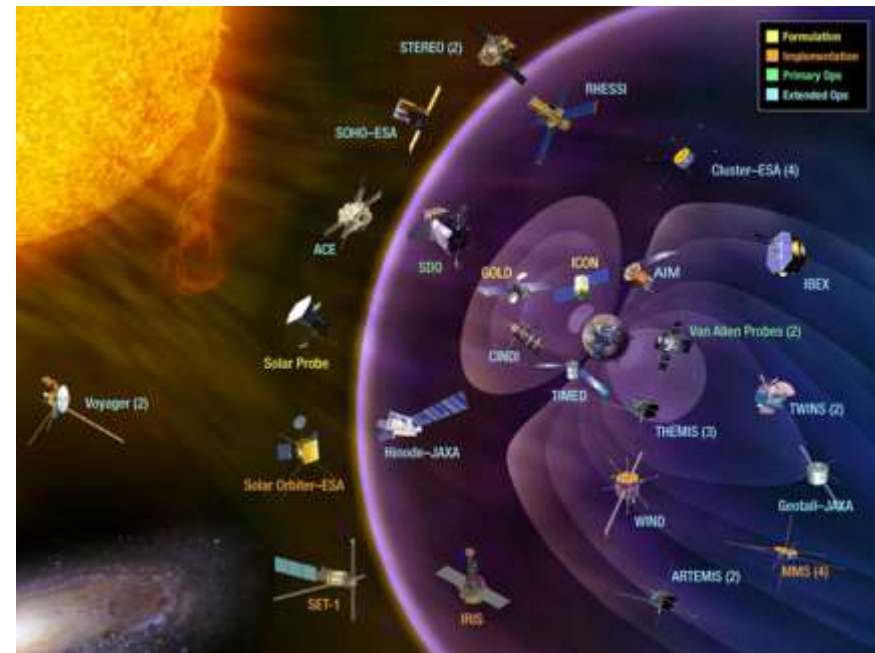
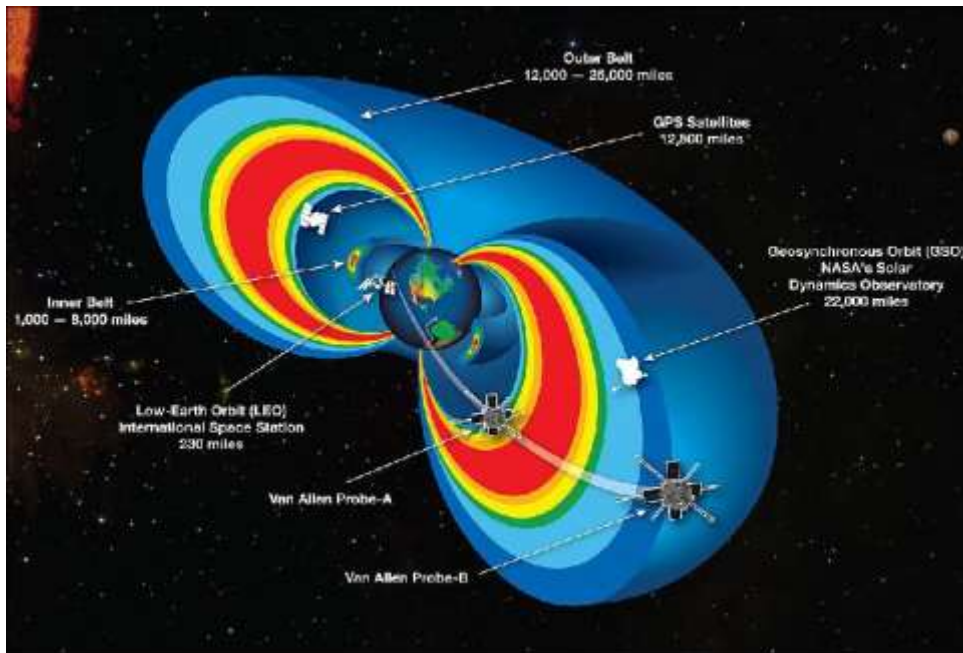

# Spacecraft Charging Environments: Cis-Lunar

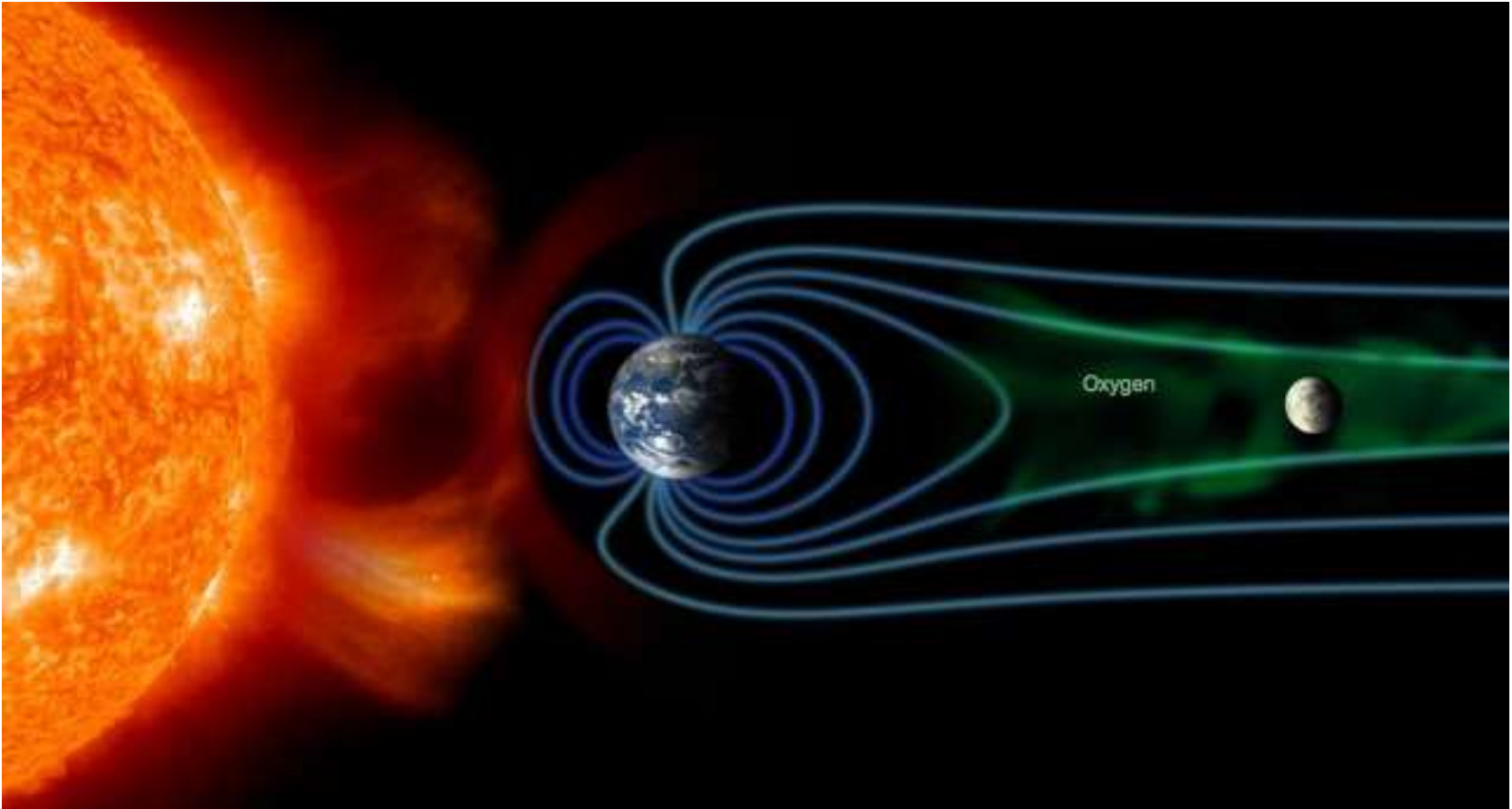

Wendel, J., and M. Kumar (2017), Biogenic oxygen on the Moon could hold secrets to Earth's past, *Eos*, 98, <https://doi.org/10.1029/2017EO066979>. Published on 30 January 2017.

# Spacecraft Charging Environments: Geomagnetic Storm and Aurora

Video Simulation Credit NASA GSFC

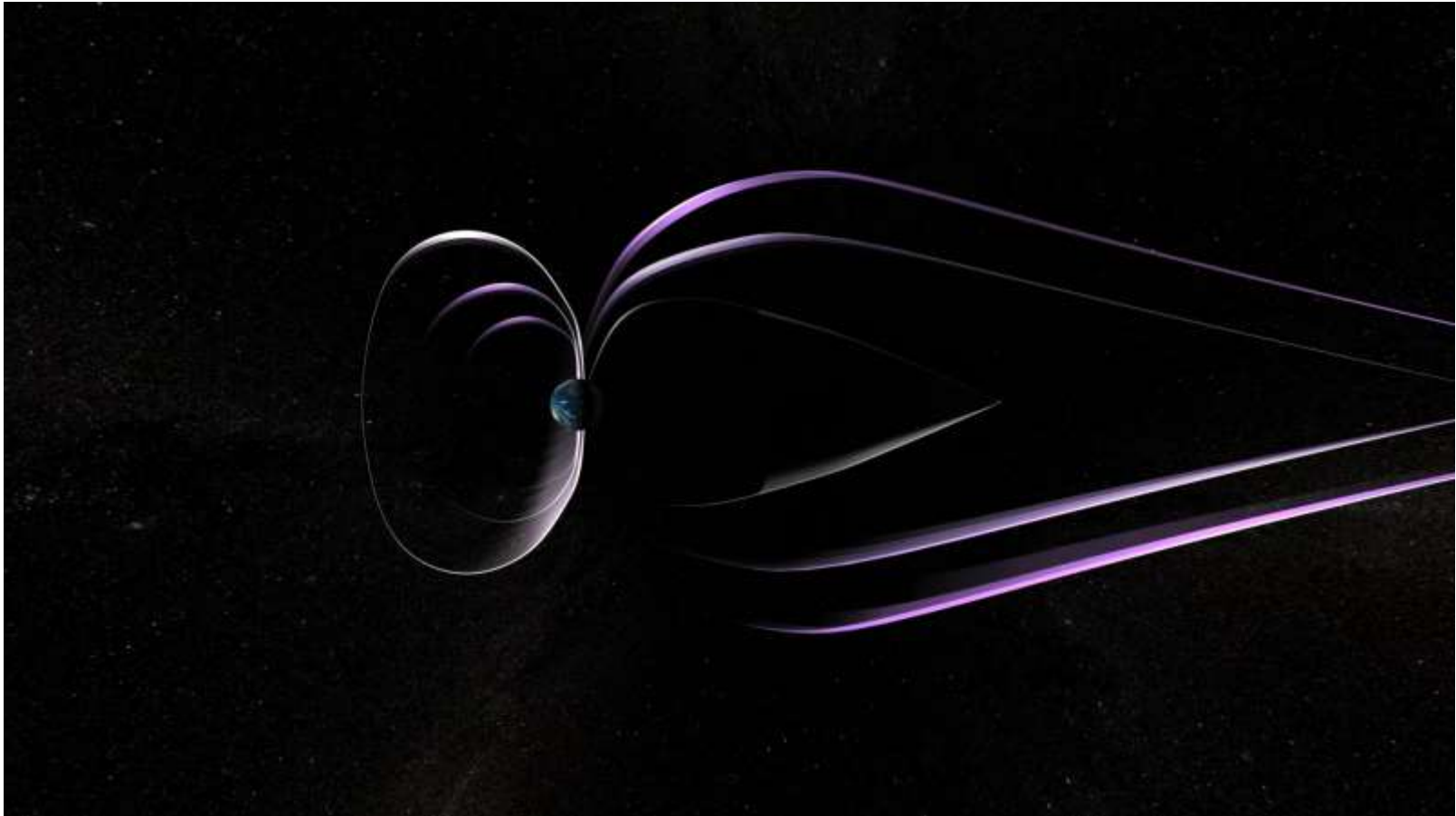
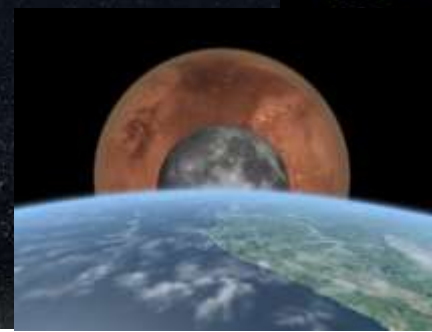

# Spacecraft Charging Environments and Processes: Space Plasmas and Energetic Particles

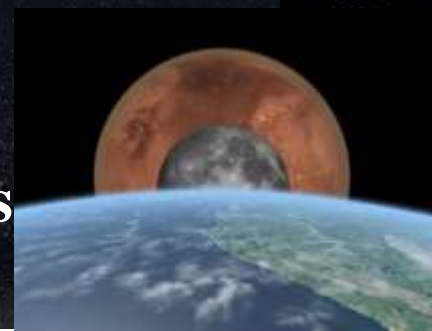

## ● Plasma – an ionized gas that conducts electricity

### ◆ Consists of neutral atoms/molecules, electrons ( $e^-$ ), and ions ( $i^+$ )

✦ Displays collective behavior (plasma, not just an ionized gas) if -

✦ **Debye Length ( $\lambda_d$ )  $\ll$  L (length of system), and Plasma Parameter ( $\Lambda$ )  $\gg$  1**

### ◆ Gas Kinetic Theory (Maxwell-Boltzmann Equation) applies

✦ All particles in a gas have the same temperature at equilibrium

✦ So all particles have the same average kinetic energy;  $v_{avg} = [(2 k T_i)/(m_i)]^{1/2}$

✦  $KE_{avg} = \frac{1}{2} m v_{avg}^2 \Rightarrow$  particle speed depends on mass

❖ **All else being equal, electrons much faster than ions so that objects in the plasma tend to charge negative relative to the plasma in a way that depends on electron temperature and electron/ion mobility;**

### ◆ Important Plasma Parameters

✦  $\lambda_d$  - **Plasmas can rearrange charges to exclude electric fields, like any conductor**

✦  $\omega_{pe}$  - Electron Plasma Frequency

✦  $\Lambda$  - Need a large number of particles inside the  $\lambda_d$  length for collective behavior

✦ FP - Floating potential of an object in the plasma

## ● Energetic Particles

### ◆ Auroral Electrons, Relativistic Trapped Electrons, SPE Electrons and Protons

◆ Not a plasma effect - more like a high voltage power supply driving current onto and into the spacecraft

# Space Plasma Environments— The Numbers

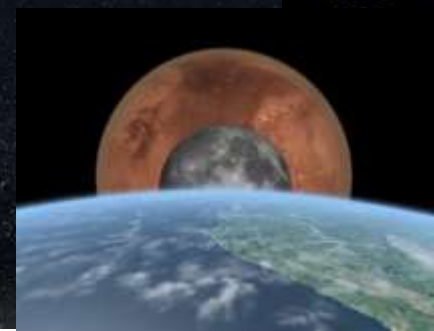

- $\lambda_d$  is also known as the sheath or shielding length
  - ◆ At distances greater than a few  $\lambda_d$ , the electric field of a charged object is cancelled by redistribution of plasma charged particles
  - ◆  $\lambda_d = 7400 \times \sqrt{(T_e/N_e)}$ ,  $\lambda_d$  in m,  $T_e$  in eV,  $N_e$  in  $e/m^3$ 
    - ✦ 1 eV =  $1.16 \times 10^4$  degrees Kelvin
- $\omega_{pe}$  determines how radio frequency (RF) electromagnetic (EM) waves interact with plasma
  - ◆  $\omega_{pe} = 9 \sqrt{N_e}$  in Hz
  - ◆ If  $\omega > \omega_{pe}$  RF signal passes through plasma
  - ◆ If  $\omega < \omega_{pe}$  RF signal is refracted or reflected by plasma
- Plasma sheaths can contribute to the capacitance of an object immersed in or moving through the plasma
  - ◆ For a sphere of radius  $R$  moving through the plasma, and neglecting wake effects:

$$C = 4\pi R^2 \epsilon_0 \left( \frac{1}{R} + \frac{1}{\lambda} \right)$$

Same equation as for two concentric spheres with separation distance  $\lambda$   
(remember -  $\lambda$  depends on plasma density and temperature)



# Space Plasma Environments – The Numbers

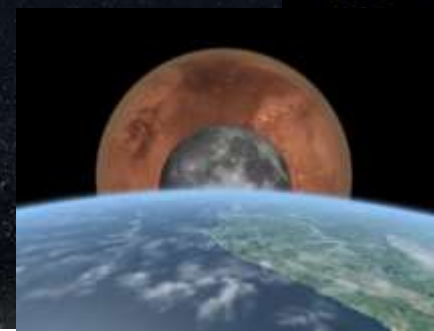

E. C. Whipple, "Potentials of Surfaces in Space," Reports on Progress in Physics, Vol. 44, pp. 1197-1250, 1981

Plasma	Density $n_e(m^{-3})$	Electron Temperature T(K)	Magnetic Field B(T)	Debye Length $\lambda_D(m)$	Electron Plasma Frequency (MHz)	Small Object FP (V)
Gas discharge high density/hot	$10^{16}$	$10^5$	--	$10^{-4}$	1000	-10
Ionosphere high density/cold	$10^{12}$	$10^3$	$10^{-5}$	$10^{-3}$	10	-1
Magnetosphere low density/hot	$10^7$	$10^7$	$10^{-8}$	$10^2$	0.01	Day, +10 Night, - 10K
Solar wind low density/hot	$10^6$	$10^5$	$10^{-9}$	10	0.01	Sun, +10 Eclipse, -20

A useful on-line plasma parameter calculator => <http://pepl.engin.umich.edu/calculator.html>

# Energetic Charged Particle Environments

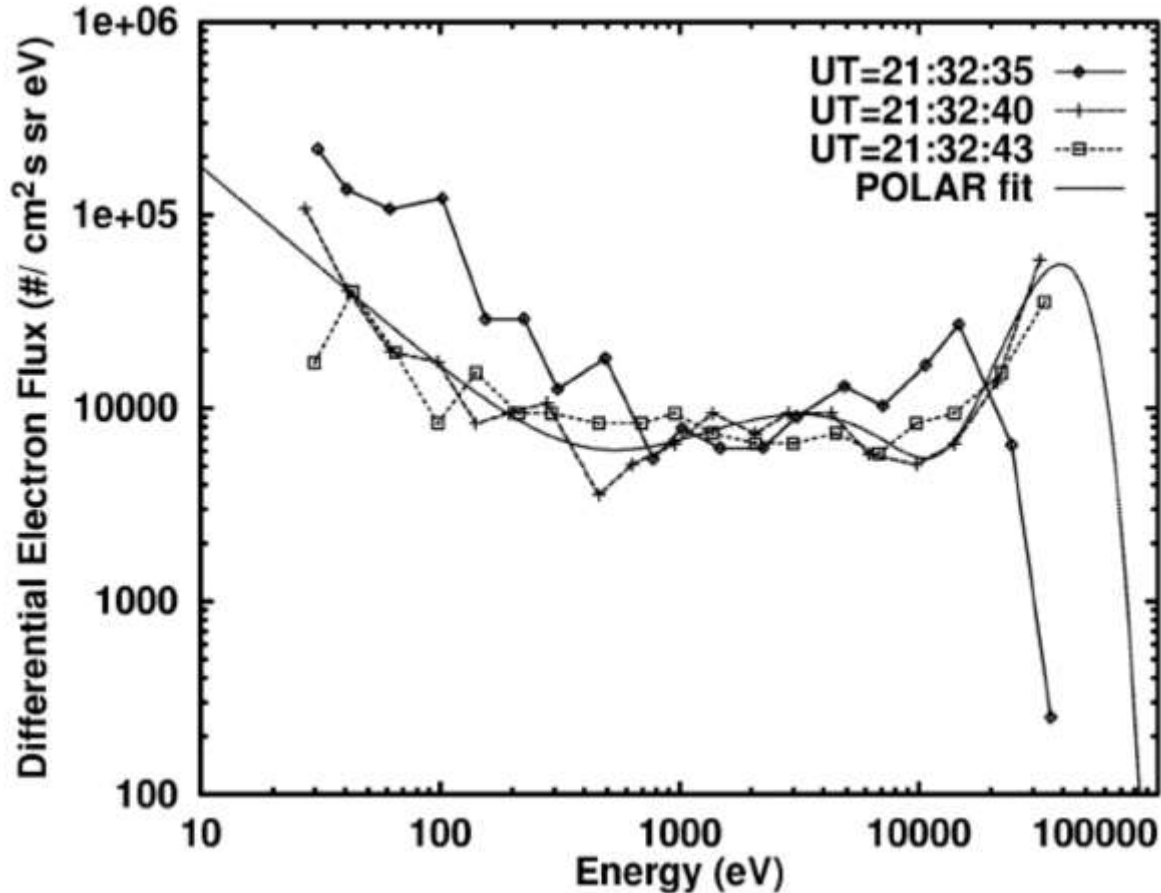

David L. Cook, "Simulation of an Auroral Charging Anomaly on the DMSP Satellite," 6th Spacecraft Charging Technology Conference, AFRL-VS-TR-20001578, 1 Sept. 2000

Auroral (diffuse + arc) Average Differential Electron Flux for an F13 DMSP charging anomaly event: **e- K.E. 0.01 to 100 KeV and flux from  $10^2$  to  $10^6$**

# Energetic Charged Particle Environments

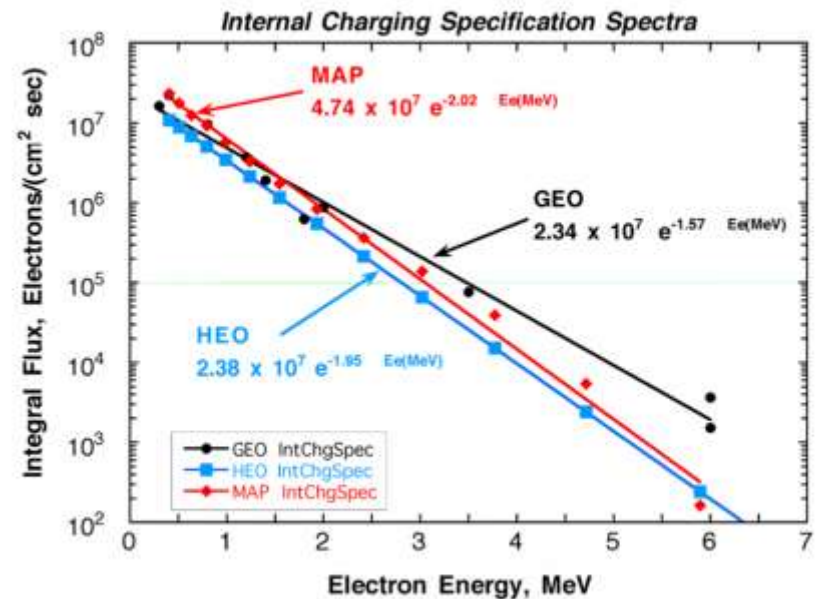
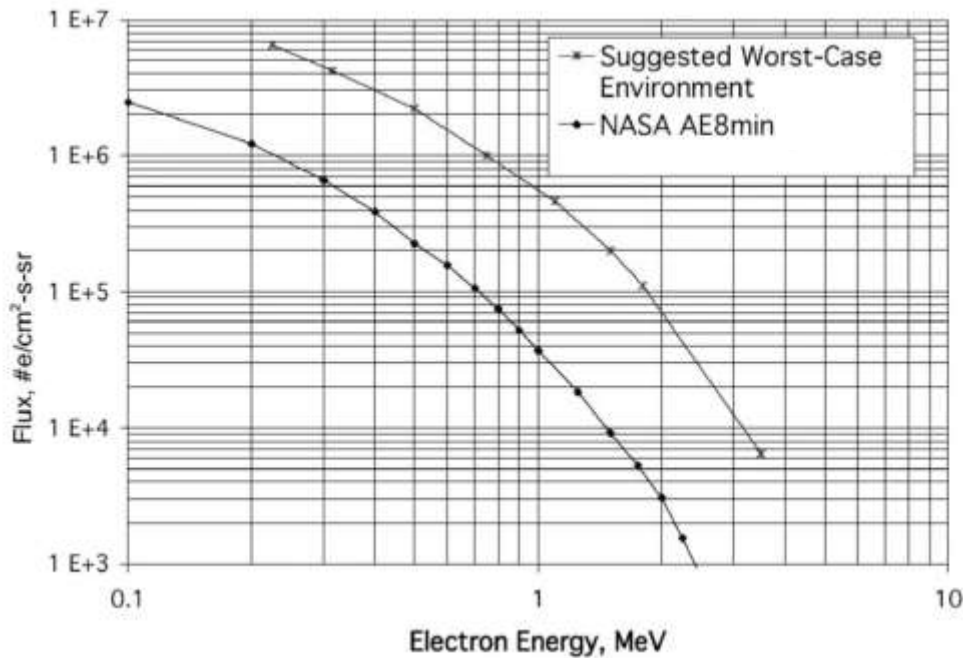
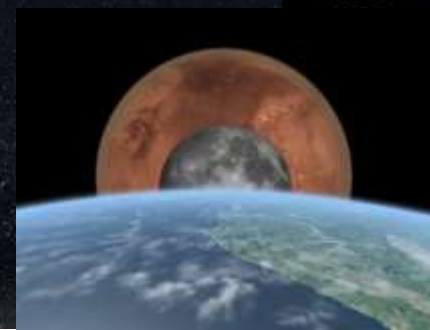

Examples of worst-case 10-hour-average electron spectra for three different orbits.

**GEO worst case design environment vs AE-8 model for solar minimum**

**GEO Average Integral Electron Flux:  
e- K.E. 0.1 to 4 MeV and flux from  $10^3$  to  $10^7$**

# Energetic Charged Particle Environments

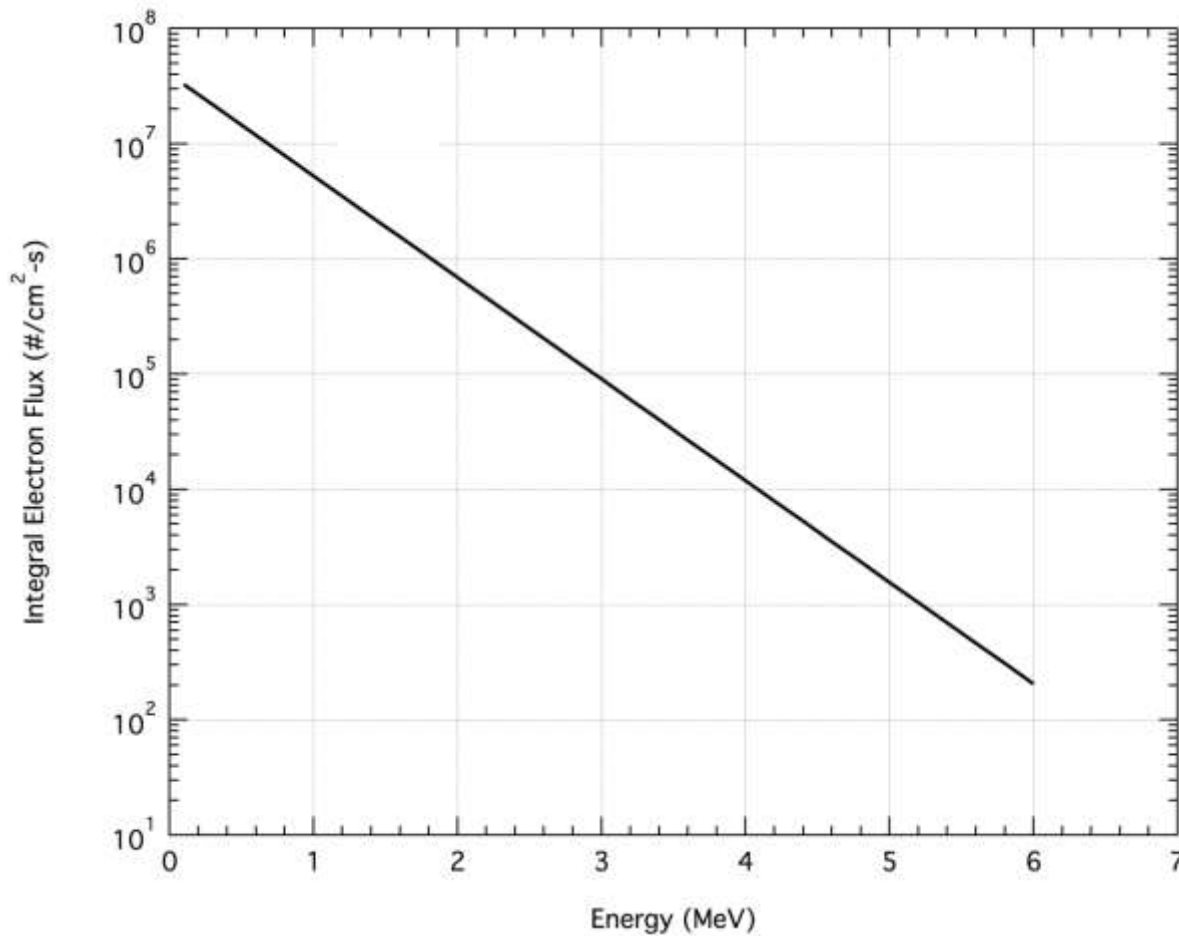
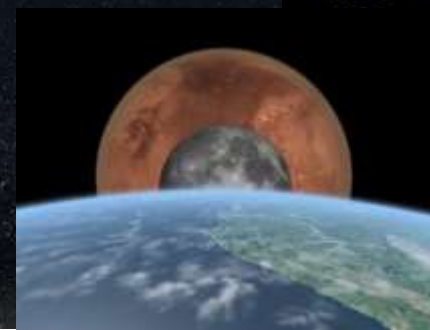

SLS-SPEC-159 REVISION  
D November 4, 2015

**Earth's Radiation Belt Transit Average Integral  
Electron Flux: e- K.E. 1 to 7 MeV and flux 10<sup>1</sup> to 10<sup>8</sup>**

# Energetic Charged Particle Environments

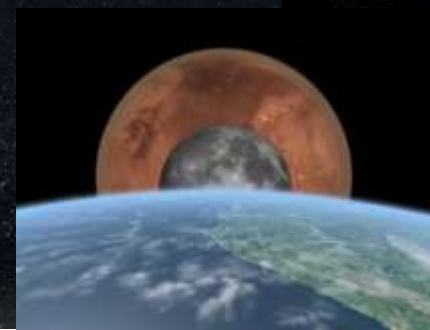

Mewaldt et al. JOURNAL OF GEOPHYSICAL RESEARCH, VOL. 110, A09S18, doi:10.1029/2005JA011038, 2005

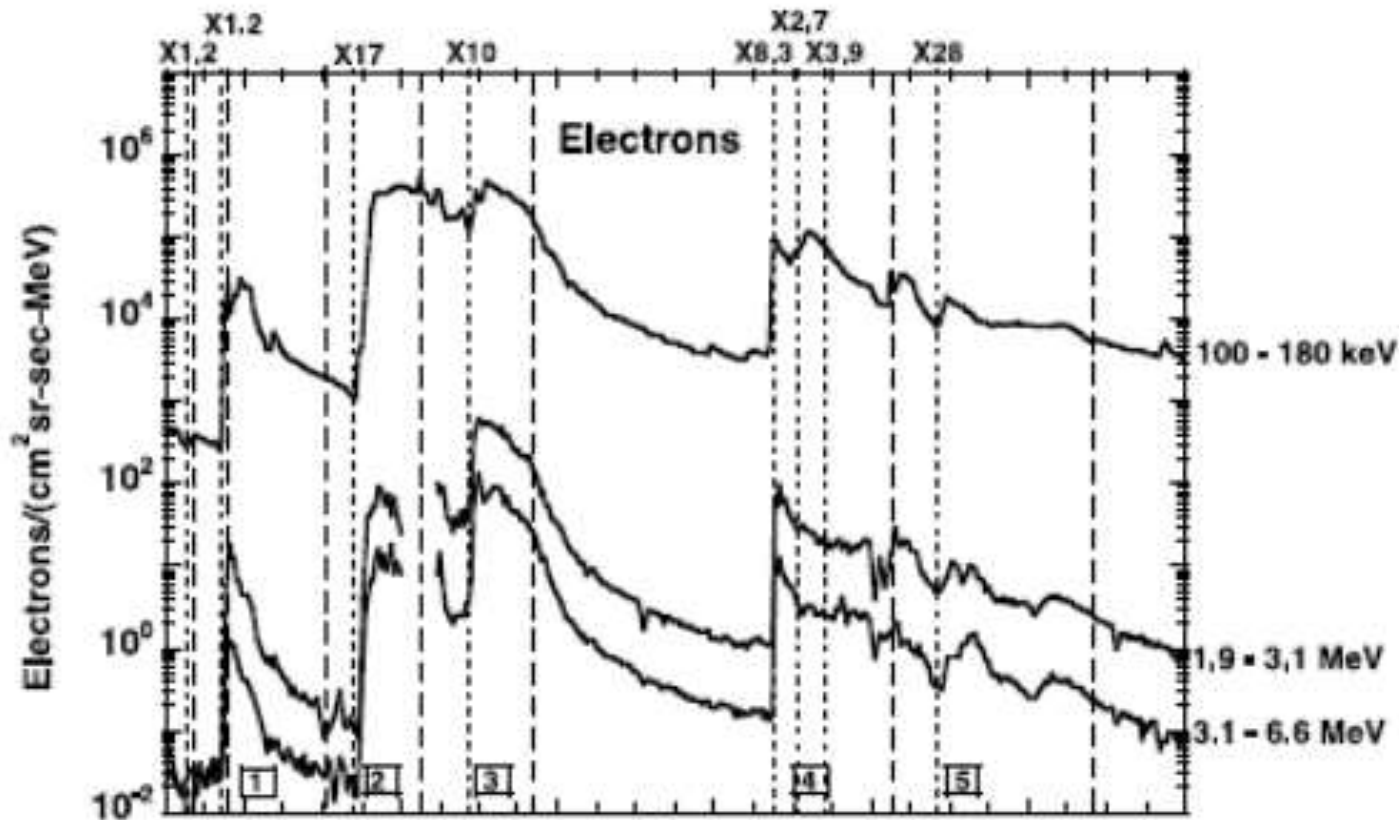

Oct. – Nov. 2003 (10/28 to 11/7) SPE events electron differential spectra – ACE spacecraft  
Electron Flux: e- K.E. 0.1 to 7 MeV and flux 10<sup>1</sup> to 10<sup>6</sup>

# Spacecraft Surface Charging Environment Risks: Geo-space

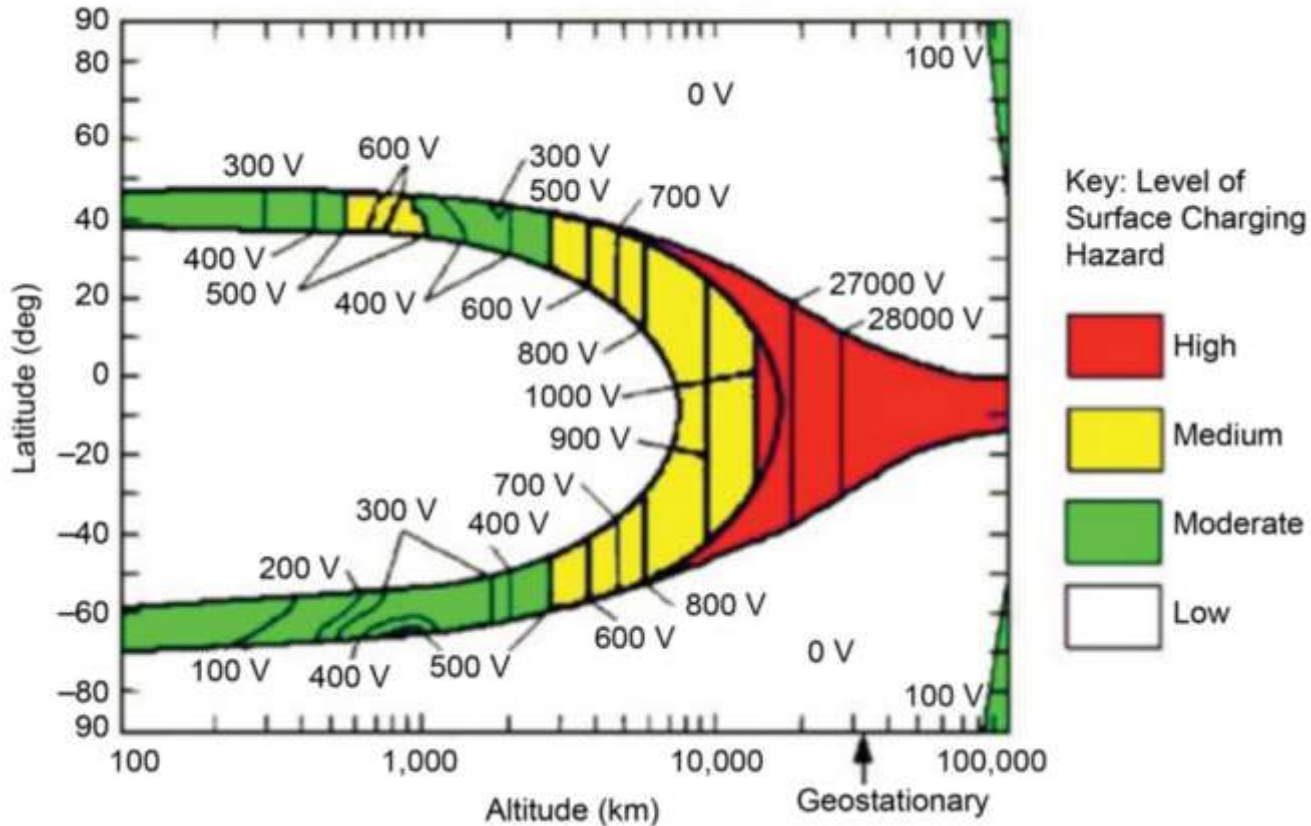
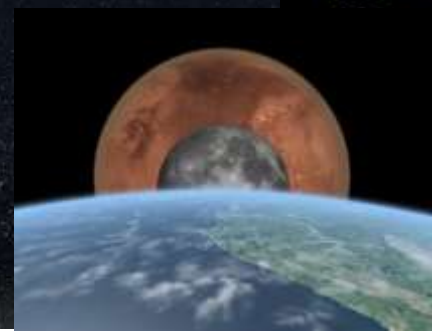

Garrett, H. B., Whittlesey, A. C.; GUIDE TO MITIGATING SPACECRAFT CHARGING EFFECTS, John Wiley & Sons, Inc., Hoboken, New Jersey, 2012, page 2

# Spacecraft Internal Charging Environments Risks: Geo-space

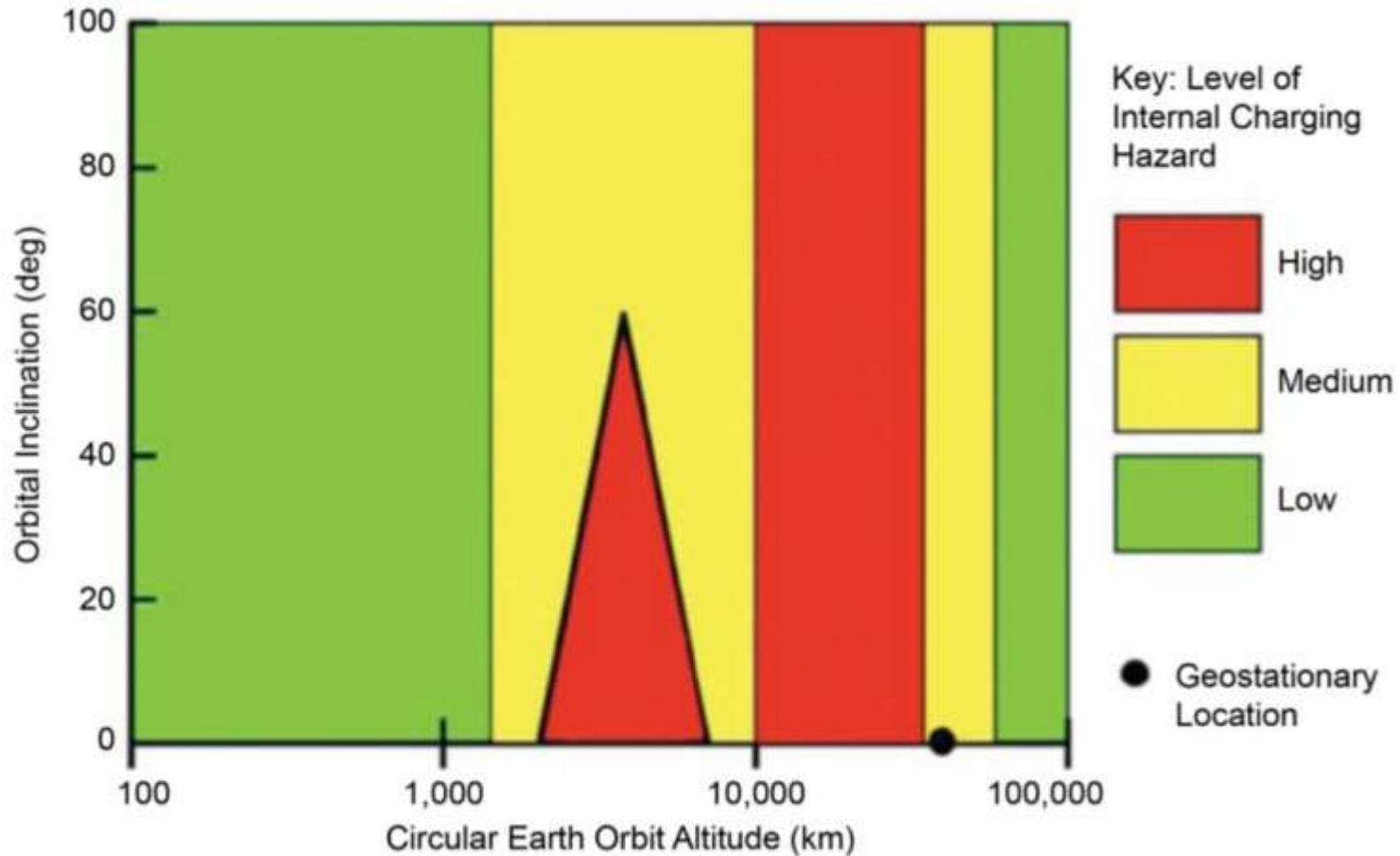
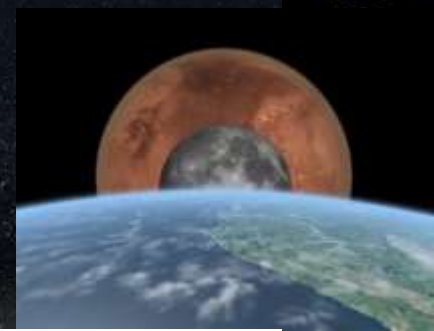



# A Simple Worked Example: Solar Array Driven Charging in LEO ( ~ ISS)



- 1) Rectangular PV array (length  $L$ , width  $W$ ) and string voltage  $V$  (end-to-end) in sunlight, with exposed metallic PV cell interconnects and a negative structure ground and negligible capacitance.
- 2) We want to calculate the FP as a function of position along the string.
- 3) Now, calculate the steady-state current balance,  $J_i = J_e$ .

$$J_i = N_i q v_i A_i \quad \text{and} \quad J_e = 0.25 N_e q v_e A_e;$$

$$v_i = V_{ISS} = 7.7 \text{ km/sec} \quad \text{and} \quad v_e = 163 \text{ km/sec} \quad (\text{corresponding to } T_e = 0.1 \text{ eV})$$

$$A_e/A_i = L_e/L_i = v_i/0.25v_e = 7.69/40.75 = 0.19;$$

- 4) The electron collecting area is a small fraction of the total area (and length) at steady-state and we can calculate FP voltage at each end of the PV array in this model.
- 5) For a **160V string**, the FP at the negative structure ground is about **-130V** and the FP at the positive end is about **+30V**.
- 6) This simple calculation works well for UARS, HTV, and many other LEO satellites (even DMSP when ionospheric density is high enough at 800 km)
- 7) This is not what we see on ISS (worst case maximum expected is -80 volts and that very, very rarely) – WHY?



# A Simple Worked Example: Solar Array Driven Charging in LEO (~ ISS)

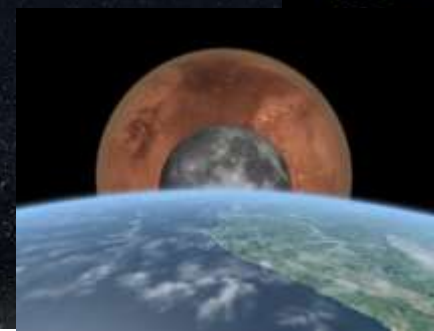

*ISS doesn't embody the assumptions underlying the simple model*

- While it is true that  $A_e/A_i \ll 1 \Rightarrow R_i \gg R_e$ , but in fact  $R_i > R_e$  because:

- ◆ 1) ISS has some exposed conducting structure to increase ion collection
- ◆ 2) ISS PV array electron collection is limited by burying PV cell metallic interconnects and current collection busses in dielectric

- The steady-state assumption is not valid given the size of the charging currents and the size of the ISS capacitor

- ◆ 3) ISS capacitance  $\gg 10^9$  pF

- ISS FP is modeled accurately (for EVA safety assessments) using the Boeing Plasma Interaction Model (PIM)

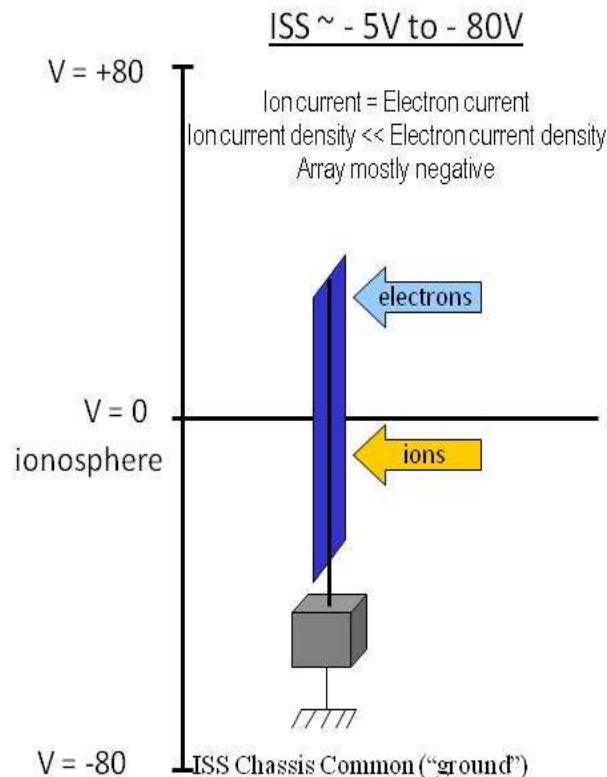

Circuit

$$I_e + I_i = 0$$

$$\frac{V+160}{R_e} + \frac{V}{R_i} = 0, R_i > R_e$$

$$V = -160 \left( \frac{R_i}{R_i + R_e} \right) \approx -5 \text{ to } -80 \text{ Volts}$$

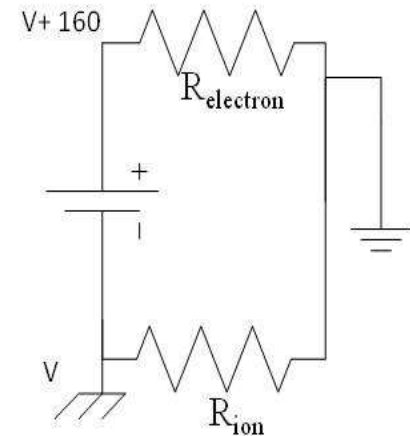

# LEO Ionospheric Plasma and Geomagnetic Field Charging Environments

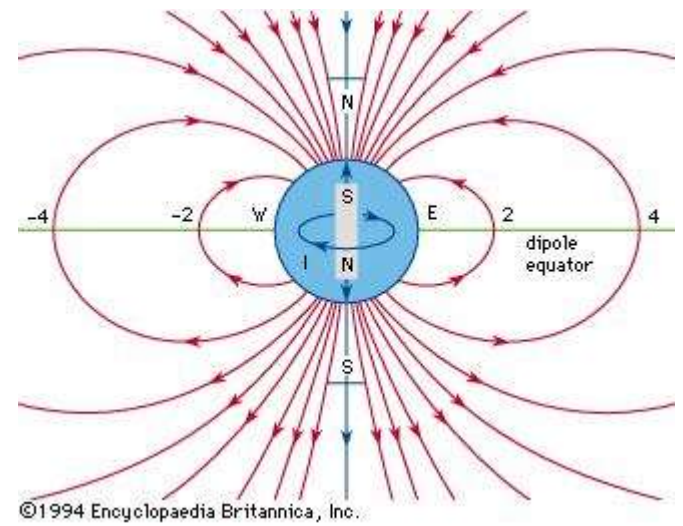
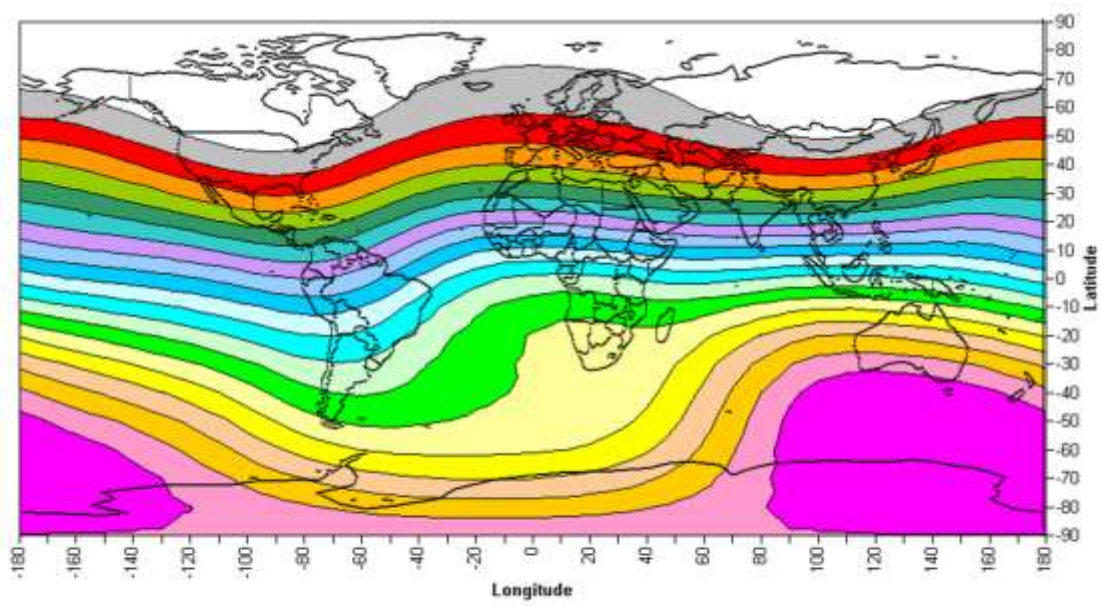
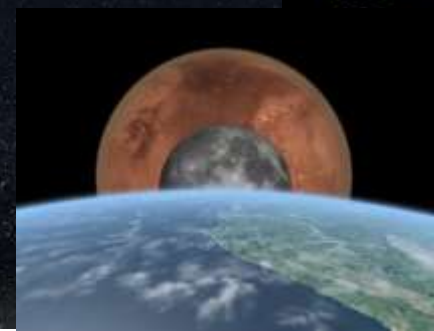

©1994 Encyclopaedia Britannica, Inc.

Magnetic Field  $B_z$  (Gauss)

■ -0.5-0.45	■ -0.45-0.4	■ -0.4-0.35	■ -0.35-0.3	■ -0.3-0.25	■ -0.25-0.2	■ -0.2-0.15	■ -0.15-0.1	■ -0.1-0.05	■ -0.05-0	■ 0-0.05
■ 0.05-0.1	■ 0.1-0.15	■ 0.15-0.2	■ 0.2-0.25	■ 0.25-0.3	■ 0.3-0.35	■ 0.35-0.4	■ 0.4-0.45	■ 0.45-0.5		

# Another Simple Worked Example: Motional EMF (magnetic induction charging) of ISS at high latitude

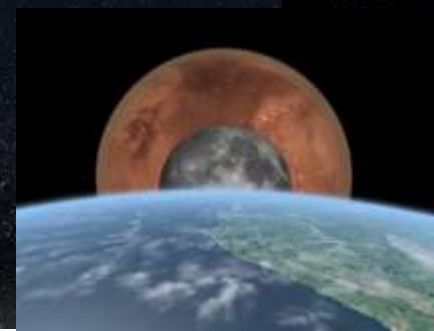

*Flying big metallic structures in LEO can lead to big motional EMF voltages across the structure as a result of the Lorentz force:*

$$V = (\mathbf{v} \times \mathbf{B}) \cdot \mathbf{L}$$

- $V$  = end-to-end voltage the spacecraft length  $L = 100$  m for ISS Truss
- $v$  = spacecraft velocity = 7.67 km/sec
- $B$  = geomagnetic field vector
- 400 km altitude and orbital inclination  $51.6^\circ \Rightarrow V \sim 50$  V at high latitude
- Using the same simple, approximate analysis used for solar-array driven charging and 50 V instead of 160 V, the area ratios will be the same with the negative end at about - 42 V and the positive end at about + 8 V
- **Motional EMF depends on orbital velocity and decreases with increasing altitude. Motional EMF is 0 at GEO**

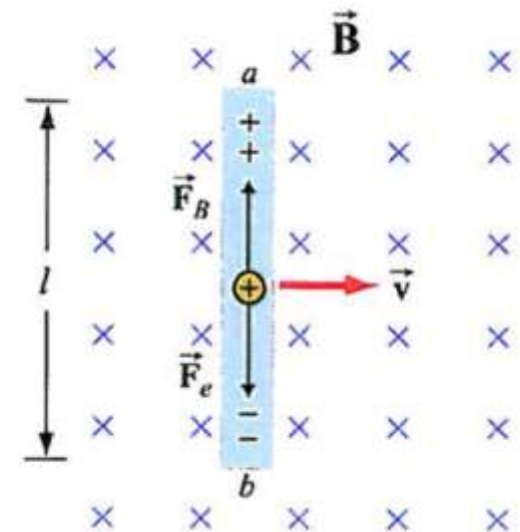
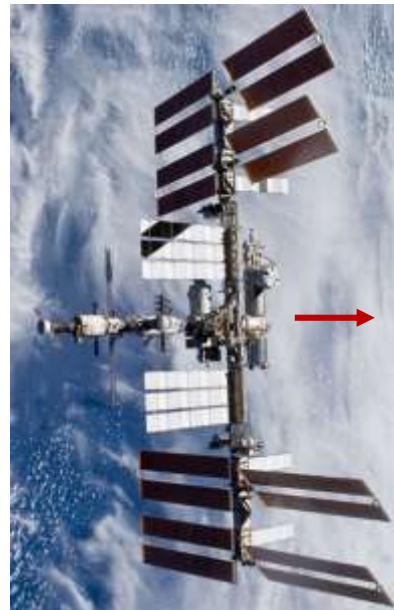

# ISS Charging Measurements: Floating Potential Measurement Unit - 2006 to 2017

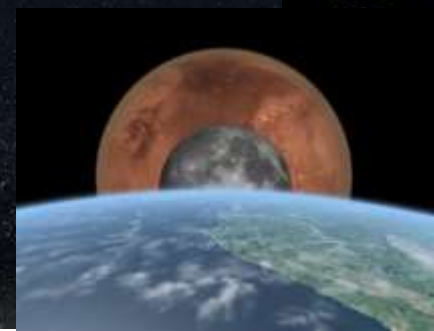

- FPMU Data Validation

ISS fly-over – MIT's Millstone Hill incoherent scatter radar

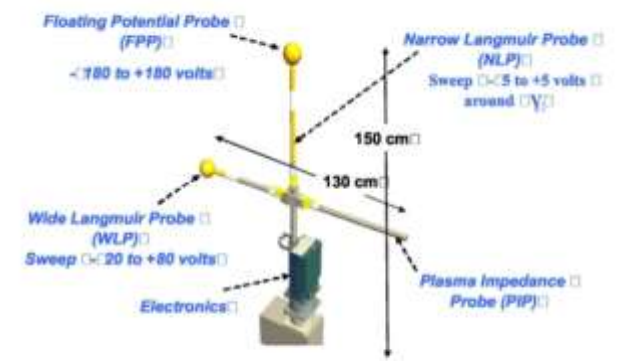
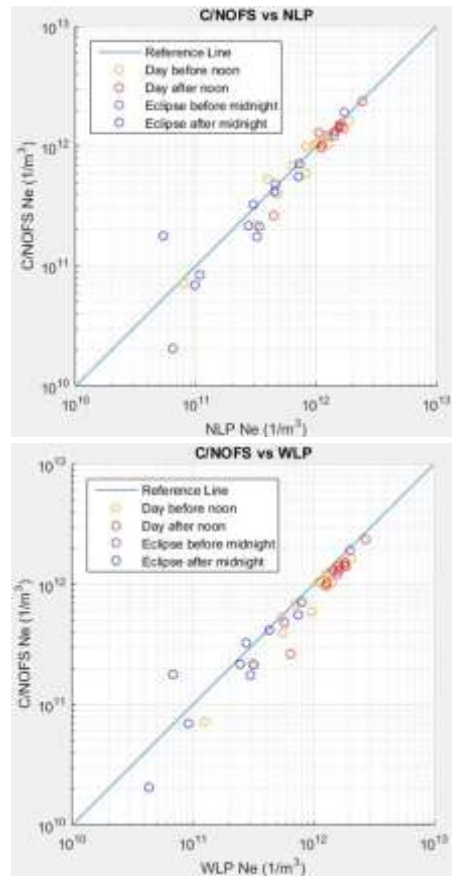
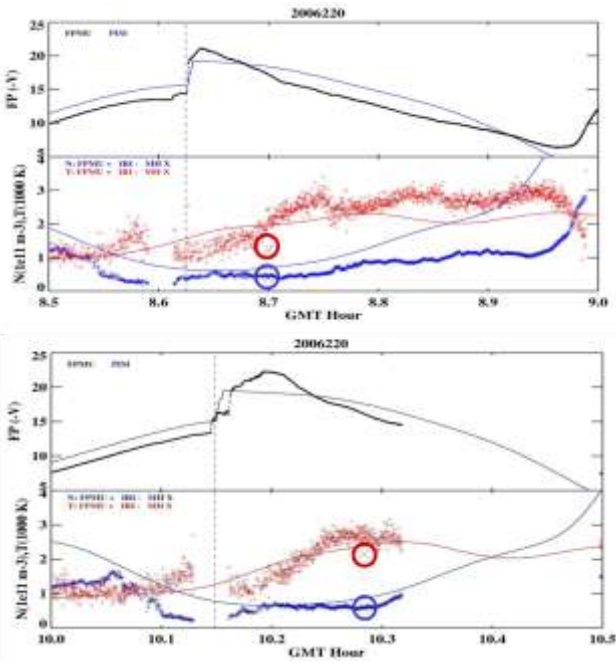

ISS orbital conjunctions with DoD  
C/NOFS Satellite  
(Ben Gingras-Boeing Space Environments)

FIG. 1: Floating Potential Measurement Unit (FPMU) conceptual instrument layout.

# ISS Charging Measurements: Floating Potential Measurement Unit - 2006 to 2017

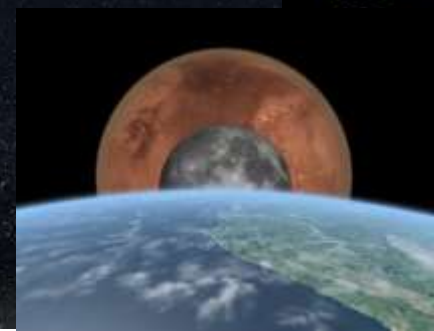

- 4 orbits of FPMU data - PCUs off

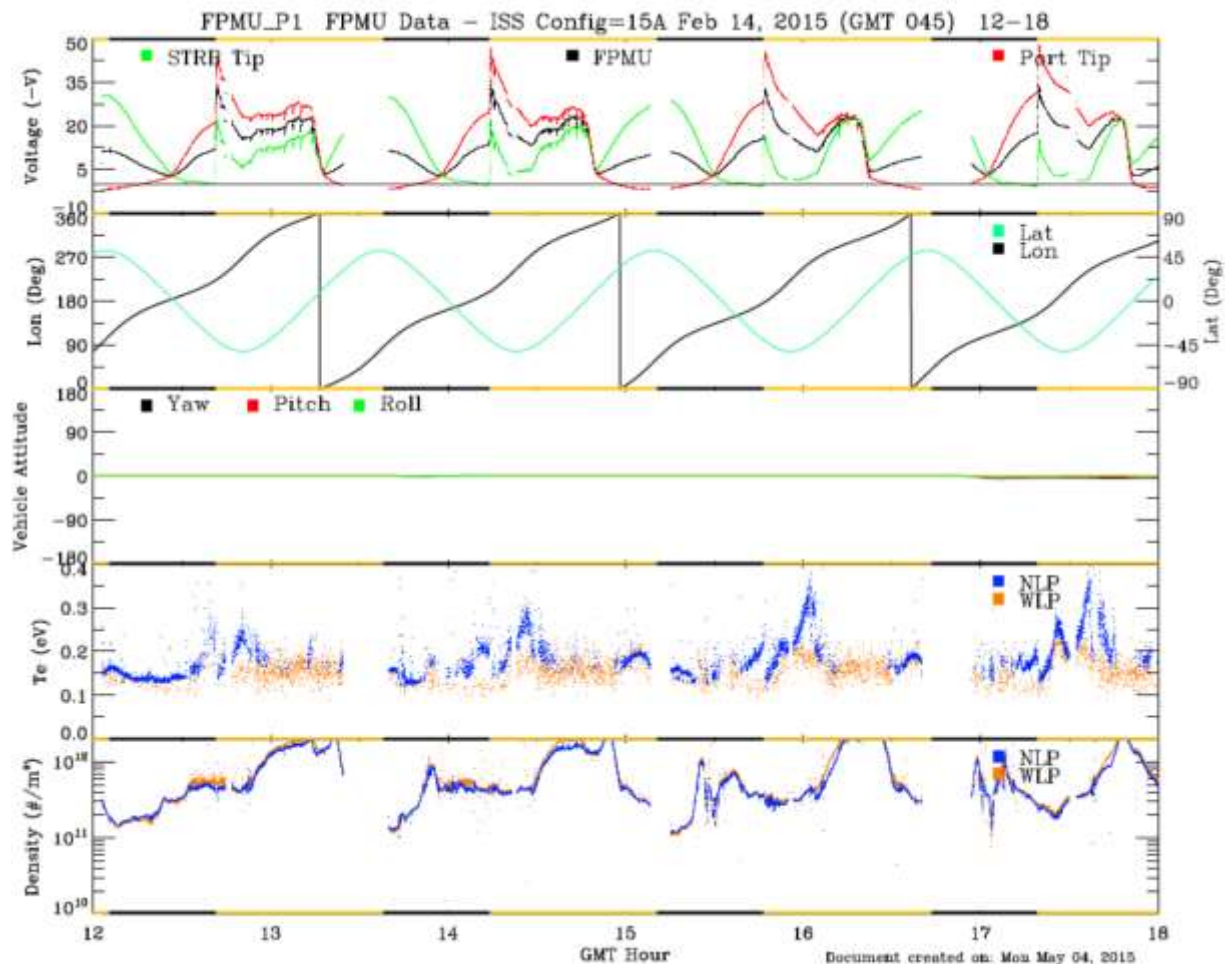

# ISS Charging Measurements: Floating Potential Measurement Unit - 2006 to 2017

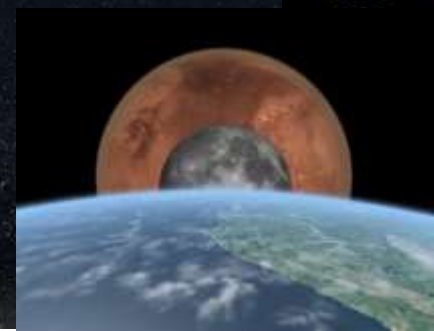

- 4 orbits of FPMU data - PCUs on

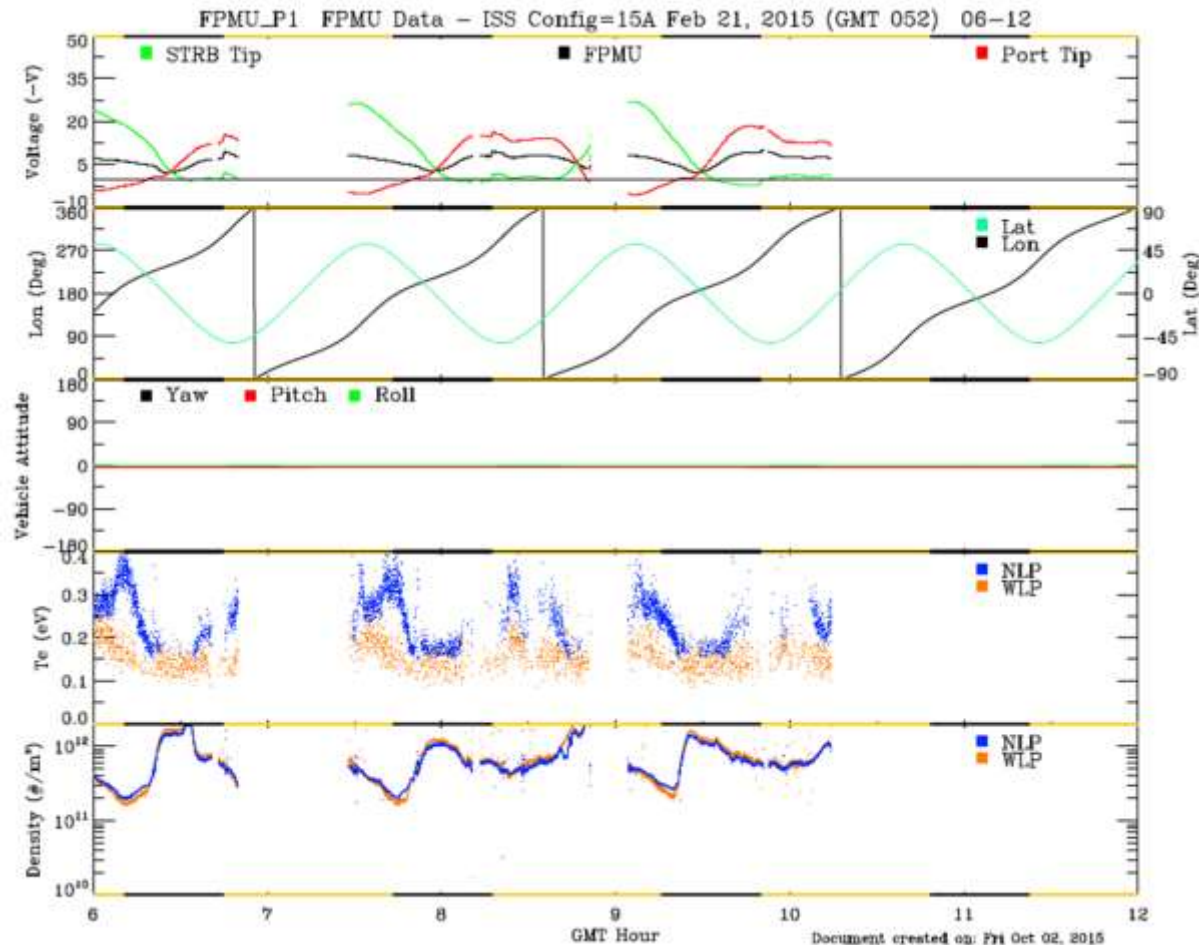

# ISS Charging Measurements: Floating Potential Measurement Unit - 2006 to 2017

**Solar Array Un-shunting (and Power on Reset, POR) Impact on ISS FP. Other rapid FP increases have been observed without un-shunt or POR (correlated with very low ionospheric plasma density)**

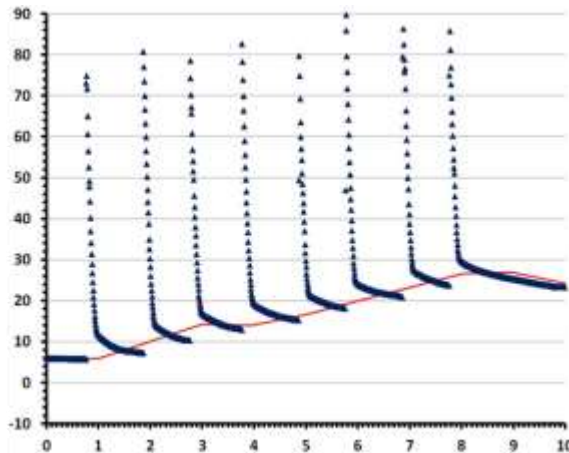

- Impact on charging due to full un-shunting ISS solar arrays when in sunlight – independent of PV array orientation with respect to the velocity vector
- Caused by a set of commands sent to the vehicle, not the natural environment

- Charging occurs in milliseconds, while the relaxation time can be from 0.04 seconds to 0.2 seconds
  - Relaxation time dependent on density. Lower density observed to have longer relaxation times
- Discharging in milliseconds for ISS environment. Charging event duration expected to be much longer in GEO or cis-Lunar environment (no ionosphere).

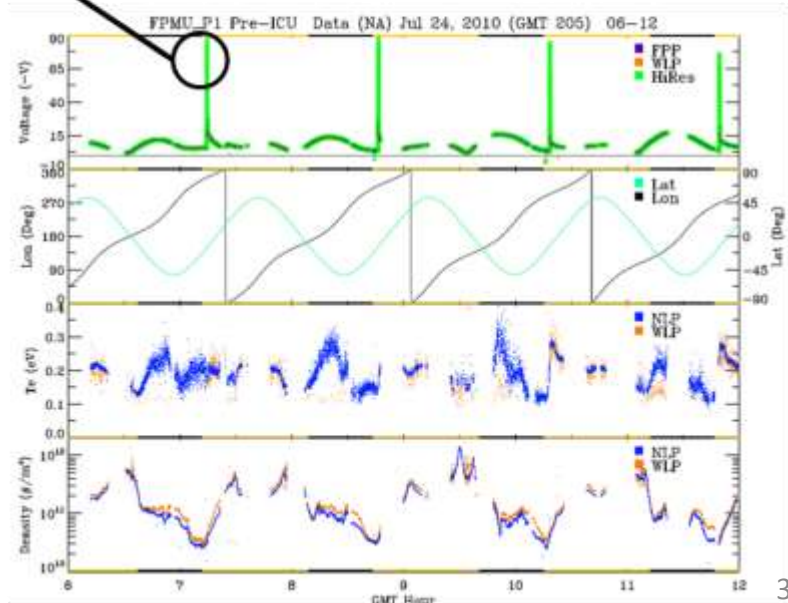

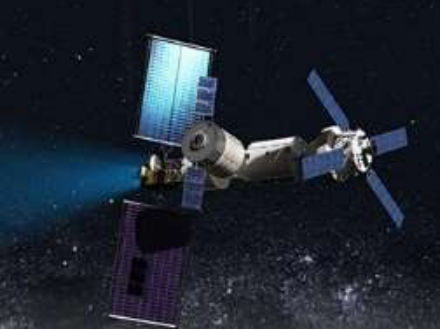

And where else might we encounter ionospheric plasmas and magnetic fields like those in the example?

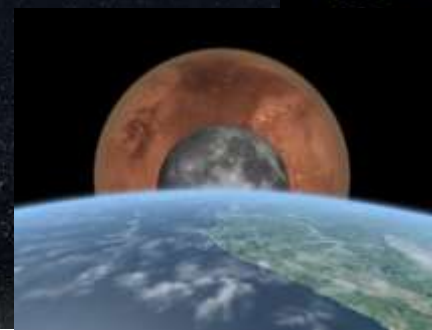

- Strong planetary magnetic fields?
  - In the **inner solar system**, only Earth and Mercury have significant magnetic fields
    - The Mercuric field is only about 1% as strong as Earth's
  - The Moon, Mars, Venus, and the near-Earth and main belt asteroids have insignificant global magnetic fields
- Cold, dense, ionospheric plasmas like Earth's?
  - Venus below about 420 km altitude (See back-up)
  - Mars below about 200 km altitude (See back-up)
  - **And one other place you might not expect...**



# The other place you might not expect...

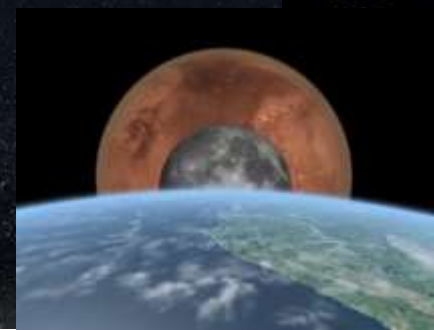

- Surrounding your  $> 200+$  kilowatt class, “high” thrust, interplanetary **transport with electric propulsion** whenever the Hall effect, electrostatic, or VASMIR engines are operating
- If EPS is photovoltaic, you can **expect high PV string voltages ( $> 160V$ )** for efficiency and large PV areas for total power requirement
- **Some risk questions to consider:**
  - How much PV array-driven spacecraft charging can I expect when the electric engines are operating?
    - **None if your PCUs are operating**
  - What happens to vehicle floating potential when the high voltage strings are un-shunted?
  - What happens if the electric engine neutralizers (e.g, PCUs) degrade or fail?
  - Will the PV arrays and power cables be at risk for arc tracking?
- **Nuclear power reduces risk, but doesn't eliminate it**
  - thermoelectric power conversion can also lead to high voltage strings exposed to the plasma (NASA SP-100)  
(<https://ntrs.nasa.gov/archive/nasa/casi.ntrs.nasa.gov/19890003294.pdf> )

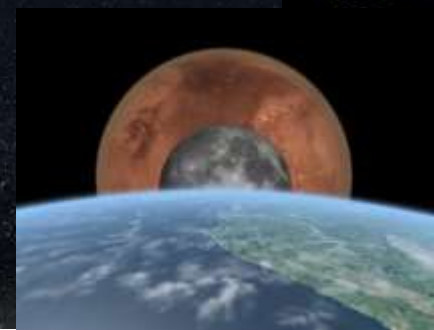

Image credit:ATK Corp.

Ira Katz, Alejandro Lopez Ortega, Dan M. Goebel, Michael J. Sekerak, Richard R. Hofer, Benjamin A. Jorns, John R. Brophy; “EFFECT OF SOLAR ARRAY PLUME INTERACTIONS ON HALL THRUSTER CATHODE COMMON POTENTIALS,” 14 th Spacecraft Charging Technology Conference, ESA/ESTEC, Noordwijk, NL, 04-08 APRIL 2016



# LEO Auroral Charging Environments



*“11:30: Transited through a very unusual aurora field. Started as a faint green cloud on the horizon, which grew stronger as we approached. Aurora filled our view field from SM (Service Module) nadir ports as we flew through it. A faint reddish plasma layer was above the green field and topped out higher than our orbital altitude.”*

**Excerpt from ISS Commander William Shepherd’s deck log of Nov. 10, 2000**

## Directly Over Aurora Australis

Videos produced by the Crew Earth Observations group at NASA Johnson Space Center

For replication and crediting information, please see our guidelines on our main video page.



# LEO Auroral Charging Environments

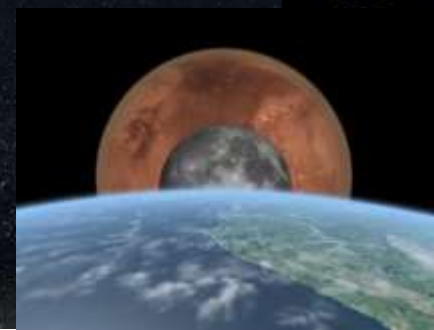

**Top: Histogram showing the charging voltage in the Freja charging events, which are binned in logarithmically spaced intervals.**

**Bottom: Polar plot illustrating their distribution in geomagnetic coordinates. Dots and stars mark weak and strong charging (less or more negative than  $-100$  V, respectively). Rings denote events in sunlight.**

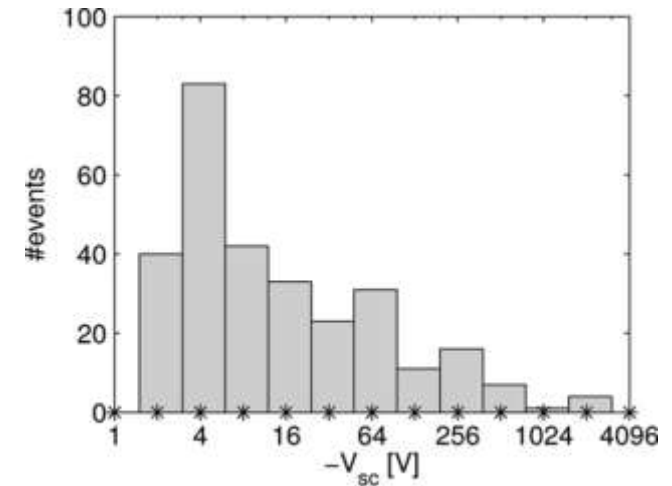

ERIKSSON AND WAHLUND: CHARGING OF THE FREJA SATELLITE IN THE AURORAL ZONE, IEEE TRANSACTIONS ON PLASMA SCIENCE, VOL. 34, NO. 5, OCTOBER 2006

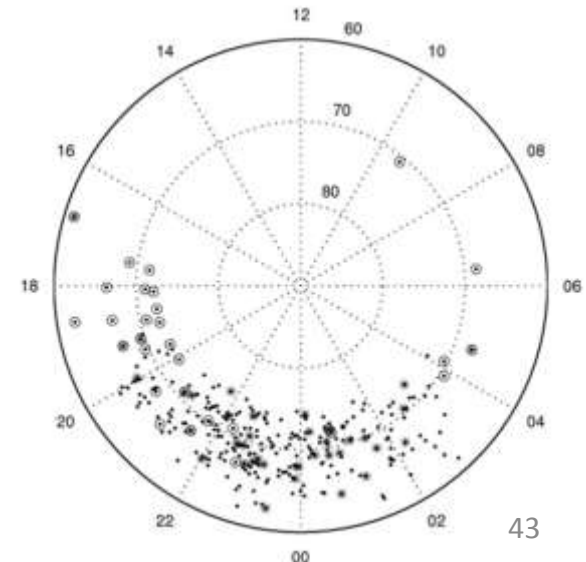
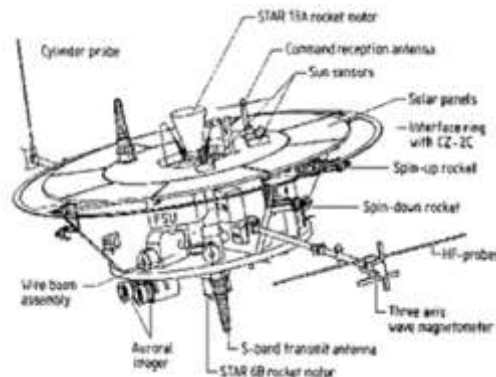

**Freja**  
<http://space.irfu.se/freja/>  
 590 to 1763 km



## Another Simple, Worked Example: Auroral Charging vs. Capacitance

- Some examples of spacecraft voltage (FP) values that might be expected using basic concepts to construct a simple auroral charging model
- Assumptions
  - ◆ The radius of the sphere or the disk is 1 m.
  - ◆ Final voltages were calculated using  $V = Q/C$  with charge  $Q$  in coulombs.  $Q = i \times \pi R^2 \times t$ , where  $Q$  is charge in coulombs,  $i$  is the net auroral electron current per unit area in amps per  $m^2$  ( $2 \times 10^{-5}$  amps/ $m^2$ ),  $\pi R^2$  is the area of the object in  $m^2$ , and  $t$  is the spacecraft auroral electron stream exposure time in seconds.
  - ◆ The particle stream kinetic energy is assumed to be 30 keV; and  $t$ , the exposure time, is 10 seconds. Note that the voltage cannot exceed the assumed kinetic energy of the incoming charged particle current.
    - ◆  $2 \times 10^{-5}$  Coulombs/sec/ $m^2$  x 10 sec =  $2 \times 10^{-4}$  Coulombs/ $m^2$
- Note that the assumed auroral electron current to the spacecraft is a net current; i.e., it is the difference between the incoming auroral electron current and the total neutralizing current, which is simply the sum of secondary and photoelectron ejection currents and the ion current;  $I_{\text{net}} = I_{\text{aur}} - (I_{\text{sec}} + I_{\text{photoelect}} + I_{\text{ion}})$ .



# Another Simple, Worked Example: Auroral Charging vs. Capacitance



## Effects of Spacecraft Capacitance on Auroral Charging

Auroral charging current =  $2 \times 10^{-5}$  amps/m<sup>2</sup> sec ; duration 10 sec.

Case	Capacitance (pF)	Floating Potential, (-Volts)
Sphere – free space (R=1 m)	111.26	30,000 (charging time < 1 second)
Sphere – 10-μ dielectric film	$1.26 \times 10^6$	2000
Disk – free space ( R = 1m)	70.83	30,000 (charging time < 1 second)
Disk – 10-μ dielectric film	$3.3 \times 10^5$	3806
Estimated International Space Station	$1.1 \times 10^{10}$	~ 13
Extravehicular Mobility Unit	$1.5 \times 10^6$	~ 27



## And how does that compare to ISS flight experience (FPMU data)

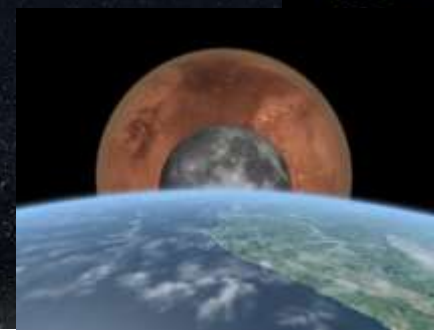

Auroral charging events have been observed in the FPMU data during eclipse at high latitudes. These events correlate with local electron density (Ne) enhancements caused by the heating and collisional ionization of the plasma.

The ISS was in the auroral zone for 144 seconds; however the times when the FP was rising (i.e., when ISS experienced discrete auroral events) were much shorter (~12 seconds).

**-18V observed compares well with the -13V estimate in the worked example table**

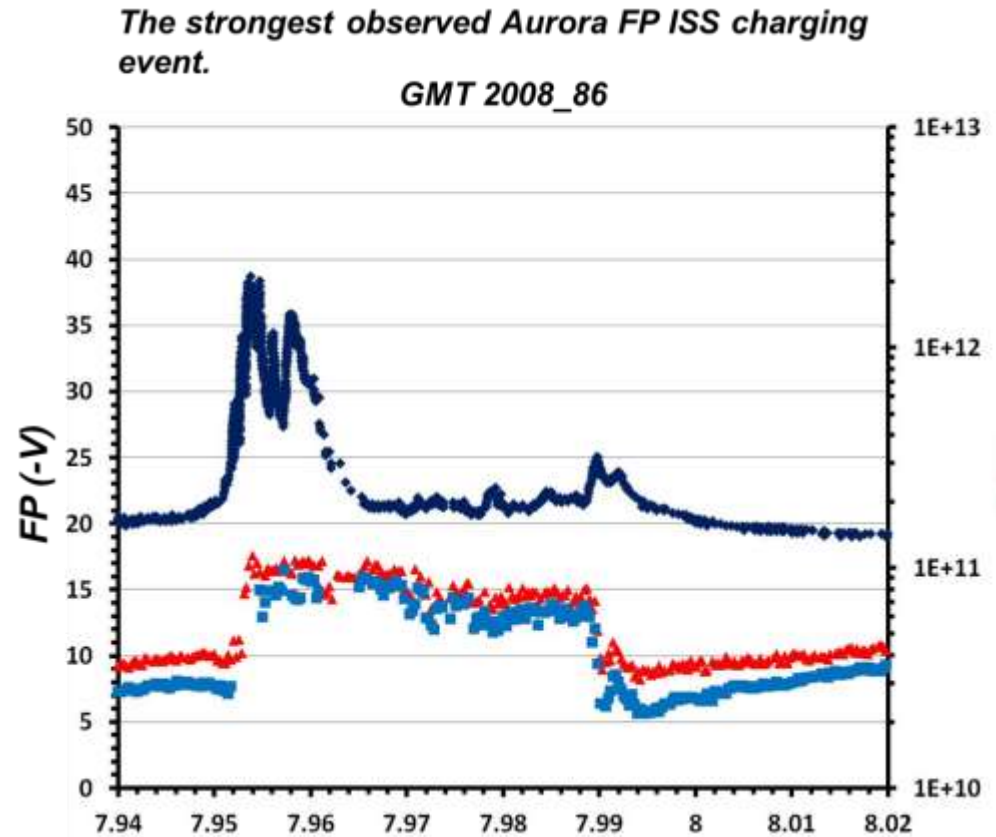

11/19/2015, Boeing Company, Drew Hartman, Leonard Kramer, Randy Olsen: ISS Space Environments SPRT meeting

# And how does that compare to ISS flight experience (FPMU+DMSP data)

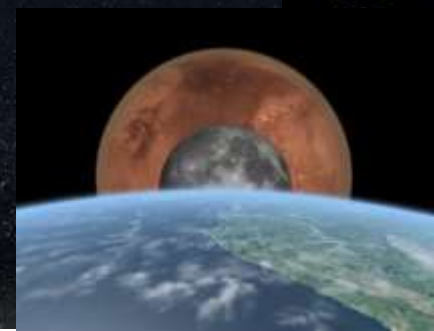

Defense Meteorological Satellite Program (DMSP) data (GMT 2008\_86) show a large frequency of current densities above  $2 \times 10^{-5} \text{ A/m}^2$  along the ISS charging event flight path <http://www.ospo.noaa.gov/Operations/DMSP/>

The red line (corresponding to 144 seconds of flight time) displays the ISS trajectory where current densities can exceed  $2 \times 10^{-5} \text{ A/m}^2$ .

The assumption in the new model of current collection on ISS anodized Al materials (auroral electrons can penetrate 30 micron chromic anodize coatings) is supported by the timelines and magnitudes of current densities.

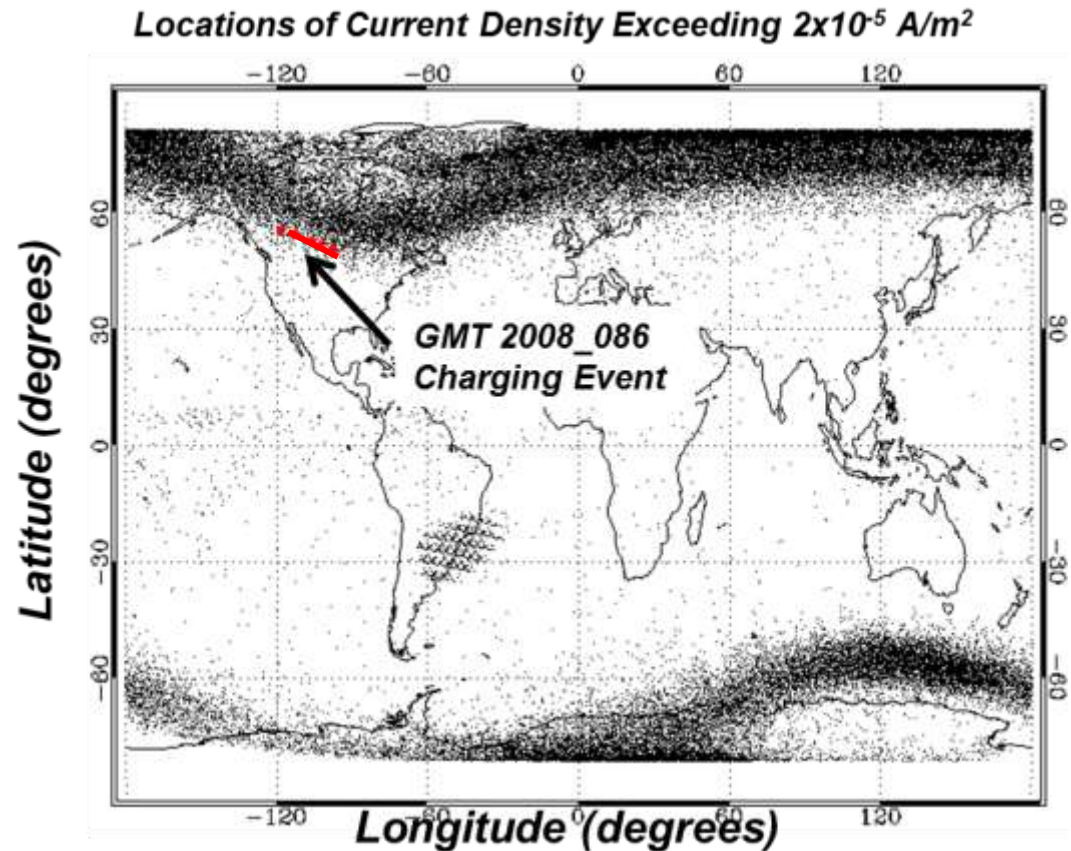

11/19/2015, Boeing Company, Drew Hartman, Leonard Kramer, Randy Olsen; ISS Space Environments SPRT meeting



# And what does this look like on a real satellite like DMSP F13?

Hint – looks like an assembly of smaller capacitors

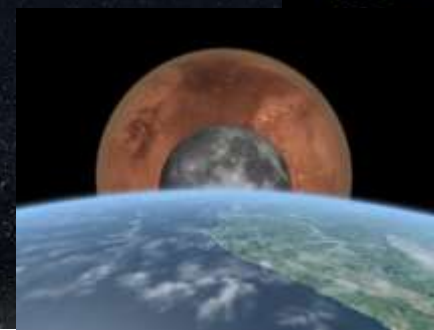

- USAF Polar charging code
- Voltage and charging timeline
  - Upper figures wake side of vehicle
  - Lower figures ram side of vehicle
- Note that individual dielectrics and conducting structure (frame) charge differently
  - David L. Cook, “Simulation of an Auroral Charging Anomaly on the DMSP Satellite,” 6<sup>th</sup> Spacecraft Charging Technology Conference, AFRL-VS-TR-20001578, 1 Sept. 2000

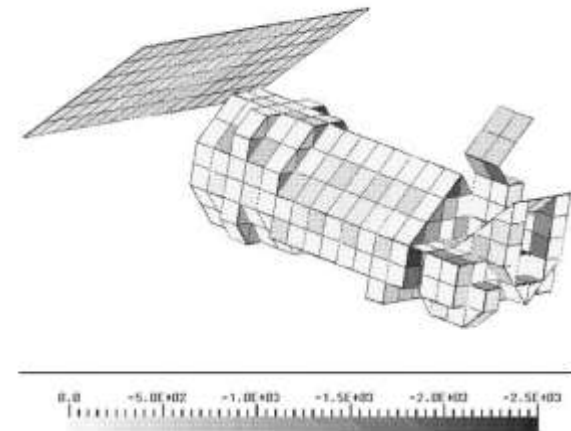
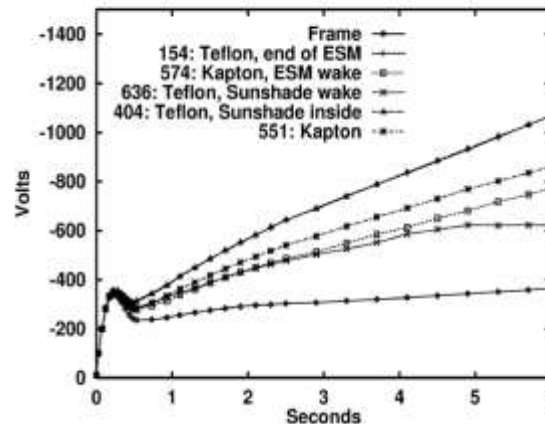
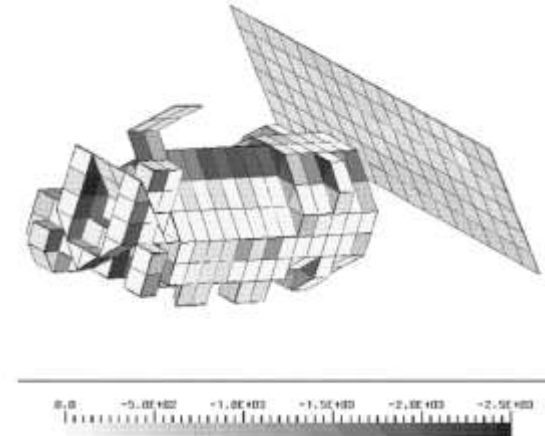
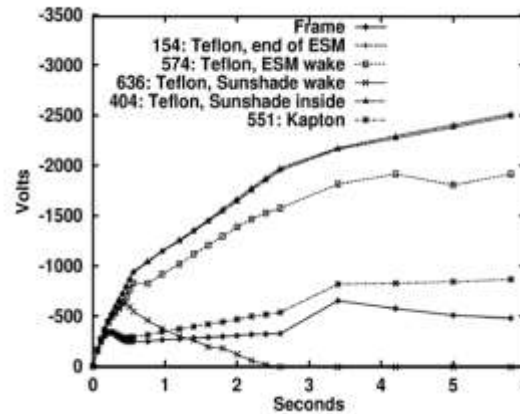



# GEO and Interplanetary Charging Environments

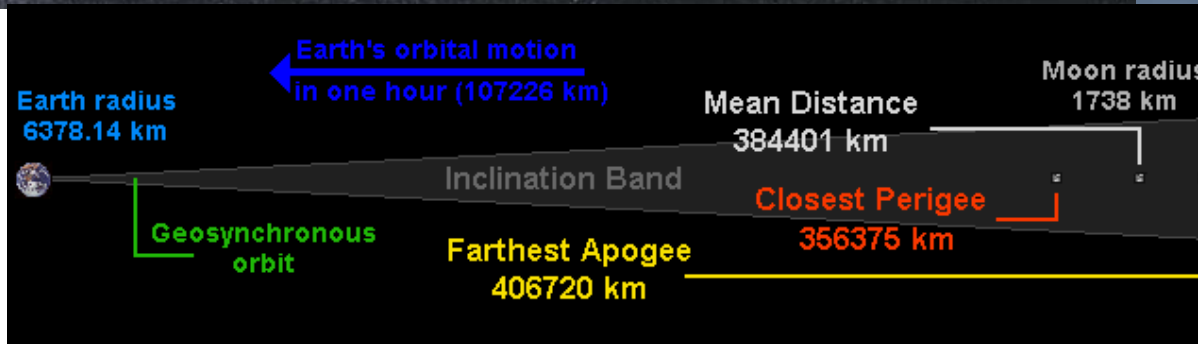

[https://www.fourmilab.ch/earthview/moon\\_ap\\_per.html](https://www.fourmilab.ch/earthview/moon_ap_per.html)

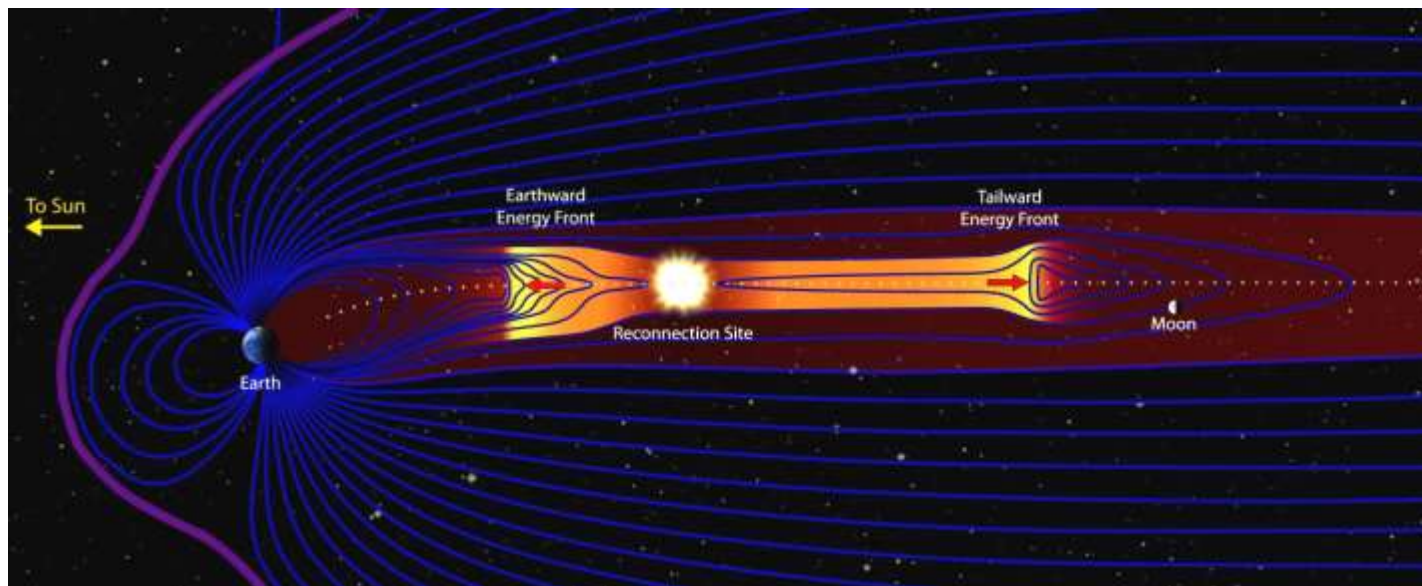

<http://artemis.igpp.ucla.edu/news.shtml>



# GEO and Interplanetary Charging Environments



- So, why are we talking about this if there are no planned long-term human flight operations at GEO and the agency focus remains the Moon and Mars?
  - The Moon is in the Geotail part of Earth's magnetosphere about 6 days every month whenever the Moon is full, or close to it, as seen from Earth
    - Similar to GEO or auroral zone charging environment and affected by geomagnetic storms
  - The GEO environment is widely considered a worst-case hot-plasma and energetic-particle spacecraft charging environment for the inner solar system
    - Only Jupiter and Saturn are worse (and a lot worse)
  - The SLS/Orion Joint Program Natural Environments Definition for Design Specification, **SLS-SPEC-159 REVISION D** November 4, 2015, calls out the GEO design environment for GEO and beyond
  - Also called out in **MPCV 70080**, May, 13, 2015, Cross Program Electromagnetic Environmental Effects (E3) Requirements Document, Section 3.7, Electrostatic Charge Control
- Spacecraft functional verification to the SLS-SPEC-159 extreme GEO design environment by test and analysis is expected to cover other interplanetary natural environments like solar particle events and coronal mass ejections as well as geomagnetic storm effects in cislunar space.

# GEO and Interplanetary Charging Environments: Surface Charging



- High temperature, low density plasma in GEO (and possibly SPE and CME) drives surface charging (relatively lower energy) environments – similar to auroral charging with much lower surface electron currents
  - Not always a neutral plasma
  - Thermal current to spacecraft surface  $\sim 0.1 \text{ nA/cm}^2$  ( $\ll$  photoelectron emission current) so charging rates can be minutes to hours - exposed surfaces can charge to high negative voltages in shade or eclipse and to small positive voltage in sunlight
  - Possible high energy arcing between shadowed and illuminated spacecraft locations on eclipse exit or in sunlight
  - Surface charging threat level is variable and affected by space-weather events
- Some Mitigations
  - Selection of static dissipative materials for exposed surfaces
  - Static dissipative coating on exposed surfaces ITO surface coatings are often used to mitigate differential surface charging
  - Active detection of surface charging threat with PCU operations to create a static dissipative plasma around the spacecraft during the threat interval

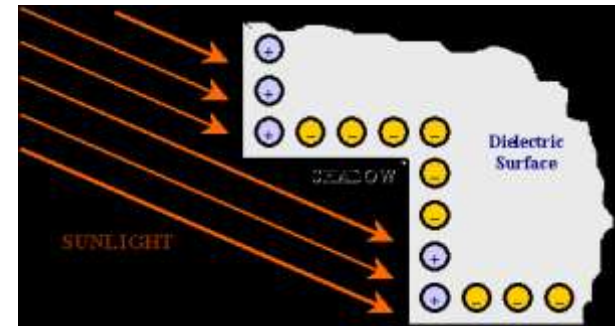

Differential surface charging because of self-shadowing in GEO surface charging environment

<http://holbert.faculty.asu.edu/eee560/spc-chrg.html>



# GEO and Interplanetary Charging Environments: Internal Charging

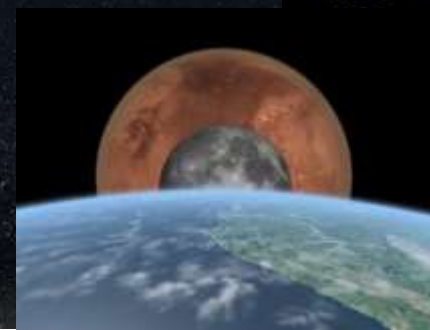

- Internal charging processes are driven by the high- energy end of the plasma electron population and the electron component of the trapped radiation and possibly the SPE environments
- Environmental risk is highly variable and driven by space-weather events
  - Safing the spacecraft during high threat times can reduce risk
- Charging rates are on the order of hours to days
- Primary Spacecraft internal charging targets are:
  - Insulators such as cable wrap,
  - Wire insulation,
  - Circuit boards and integrated circuits,
  - Electrical connectors,
  - Feed throughs,
  - Arc-tracking can be an important hazard effect
- Internal charging hazard risk depends on material properties and configuration (shielding mass helps)
  - Secondary electron emission yield
  - Dielectric thickness -  $d$
  - Resistivity -  $\sigma$
  - Relative permittivity -  $\epsilon$
  - **And their ratio, the dielectric time constant -  $\tau = \epsilon/\sigma$**

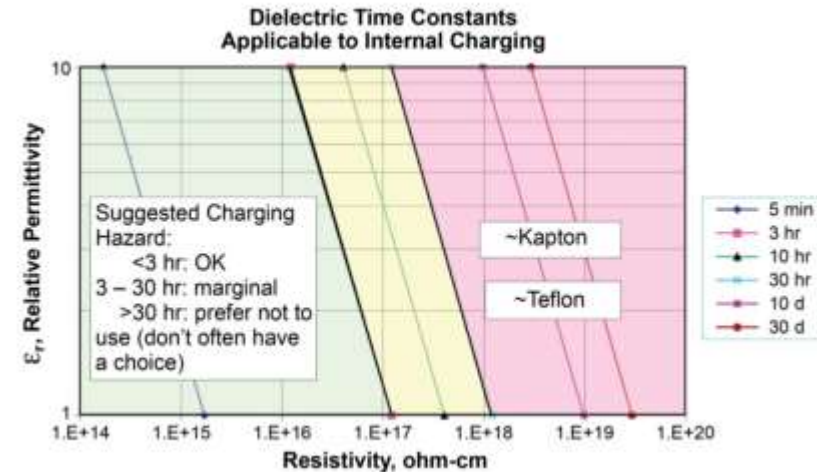

[descanso.jpl.nasa.gov/SciTechBook/st\\_series3\\_chapter.html](https://descanso.jpl.nasa.gov/SciTechBook/st_series3_chapter.html)

Very approximately we can estimate the voltage across the dielectric from the electron charging current and the material properties...

$$J \text{ [A/cm}^2\text{]} = [e/\text{cm}^2 \cdot \text{sec}] q \text{ [C/e]}$$

$$E(t) = V(t)/d = J/\sigma [1 - \exp(-t/\tau)]$$

For a more exact treatment see

<https://descanso.jpl.nasa.gov/SciTechBook/series3/11DIntnlChging.pdf>



# GEO and Interplanetary Charging Environments:

## Charging modeling and observations in cislunar space

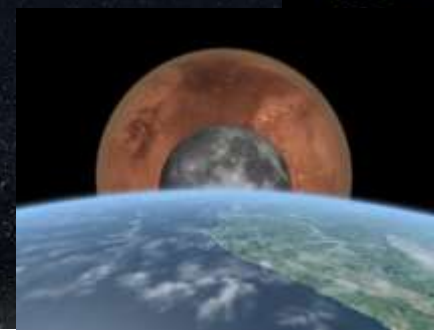

- The Moon has no atmosphere capable of blocking solar wind plasma or energetic particles
  - Orbiting spacecraft and the lunar surface are exposed to similar charging threat environments
- **Lunar Orbital/Surface Charging Threat Environments**
  - Earth's magneto-tail (current sheet) hot plasma electrons - A few days on each side of full moon as viewed from Earth
  - Solar Particle Events (energetic electrons and protons)
- **Lunar Prospector cislunar Charging Observations - SPE**
  - Lunar surface night-side surface potentials to -4.5 kV
  - Spacecraft potentials to -100 to -300 V
- **Lunar Prospector cislunar Charging Observations – Geotail current sheet region**
  - Lunar surface potentials -100 V to -1000 V in sunlight
  - Spacecraft potentials -40 to -80 V
- **Artemis/Themis Charging Observations**
  - Lunar surface potentials -20 V to -600 V, depending on current sheet electron temperature
- **Bottom line for now – cislunar environment can be similar to GEO and auroral charging environments, but less severe**
  - The GEO design environment should cover expected conditions
  - However, more charging environment data is needed here

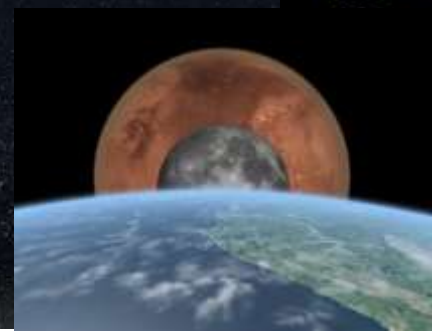

# Space Weather and Charging Environment Variability



# Space Weather and Charging Environment Variability

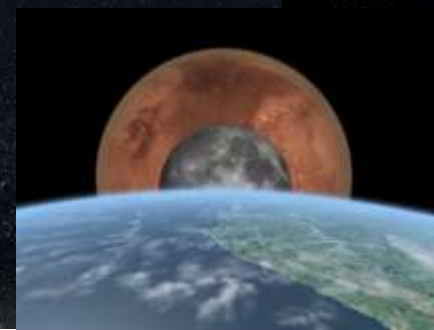

- Geospace, Cis-Lunar, and interplanetary environments are subject to substantial space weather driven variability
  - Ionospheric and solar wind space plasmas
  - Radiation belts
  - Solar particle events
  - Solar flares and Coronal Mass Ejections
  - Geomagnetic storms
- <http://spaceweather.com/>
  - A useful site for the novice and the experienced space environments specialist
- **National Oceanics and Atmospheric Administration (NOAA) Space Weather Prediction Center – Boulder, Colorado**
  - <http://www.swpc.noaa.gov/>
  - Really massive resource that you should explore
- With respect to spacecraft charging, there isn't a lot you can do to "safe" the vehicle during a space-weather event.

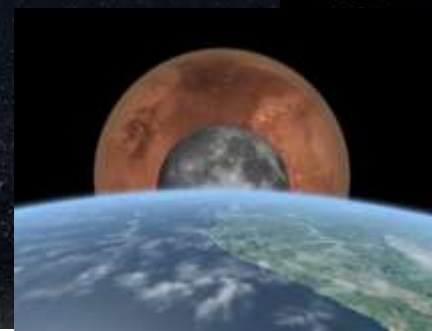

**So what do I do about all this and  
what happens if I don't?**





# So what do I do about all this?

- **What is the Charging Environment for the design reference mission, and does it cover a reasonable worst case?**
- **How much charging can I expect and when?**
- **How do I prevent the charging or render it harmless?**
  - ◆ **Grounding, bonding, and EMI/EMC compatibility**
    - ✦ PC board design rules to minimize internal charging/discharging risks
    - ✦ Eliminate potentially hazardous EPS/Avionics configurations
    - ✦ Can I direct charging/discharging currents around or away from critical, sensitive equipment and astronauts?
  - ◆ **Materials selection and static dissipative coatings**
    - ✦ Is shielding mass for worst-case energetic electron charging environment possible?
    - ✦ Can I select static dissipative or low-charging materials?
  - ◆ **Active control during severe charging events (i.e., a PCU or something like it)**
  - ◆ **Are there any options for operational hazard controls such as powering down high-voltage systems during extreme charging events?**
- **Become familiar with NASA and DoD Standards, Guidelines, and Preferred Practices for managing spacecraft charging (see the back-up)**
- **See the JPL Voyager spacecraft charging design and verification process - Voyager survived the Jupiter and Saturn fly-by environments only because charging hazards were mitigated by design and verification before flight.**
- **A. C. Whittlesey, “Voyager electrostatic Discharge Protection Program,” IEEE International Symposium on EMC, Atlanta Georgia, pp. 377-383, June 1978**
- ***Garrett, H. B., and A. C. Whittlesey. Guide to Mitigating Spacecraft Charging Effects, John Wiley and Sons, Hoboken, New Jersey, 2010***

# And what happens if I don't? ADEOS – II: Probable auroral charging/discharging event, leading to loss of mission



- **Orbit**
  - ◆ *Polar - Sun-synchronous*
  - ◆ *Orbit Altitude 802.92km*
  - ◆ *Inclination 98.62 deg*
  - ◆ *Period 101 minutes*
- **Failure**
  - ◆ *On 23 October 2003, the solar electrical power system failed after passing through the auroral zone (high altitude)*
  - ◆ *At 23:49 UTC, the satellite switched to "light load" operation because of an unknown error. This was intended to power down all observation equipment to conserve energy.*
  - ◆ *At 23:55 UTC, communications between the satellite and the ground stations ended, with no further telemetry received.*
  - ◆ *Further attempts to procure telemetry data on 24 October (at 0025 and 0205 UTC) also failed.*
- *JAXA determined that the total loss of ADEOS-II, a PEO satellite with bus voltage of fifty volt, attributed to interaction between the auroral electron/plasma environment and the improperly grounded MLI around the main EPS wire harness causing a destructive "arc tracking" failure of the wire harness.*
- *The loss of ADEOS-II investigation revealed that auroral charging of a polar satellite could cause serious failure, including total loss.*
- *MM/OD impact creating an arc plasma and triggering the main discharge on the power harness is another possibility*



- 1) Kawakita, S., Kusawake, H., Takahashi, M. et al., "Investigation of Operational anomaly of ADEOS-II Satellite," Proc. 9<sup>th</sup> Spacecraft Charging Technology Conf., Tsukuba, Japan, 4-8 April 2005.
- 2) Nakamura, M., "Space Plasma Environment at the ADEOS-II anomaly," Proc. 9<sup>th</sup> Spacecraft Charging Technology Conf., Tsukuba, Japan, 4-8 April 2005.



# And what happens if I don't? ADEOS – II: Probable auroral charging/discharging event, leading to loss of mission

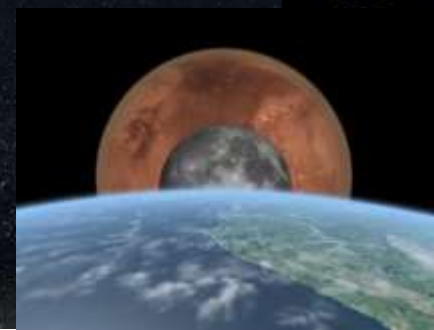

- Kawakita et al, “Investigation of an Operational Anomaly of the ADEOS II Satellite”, AIAA 2004-5658 (2004)

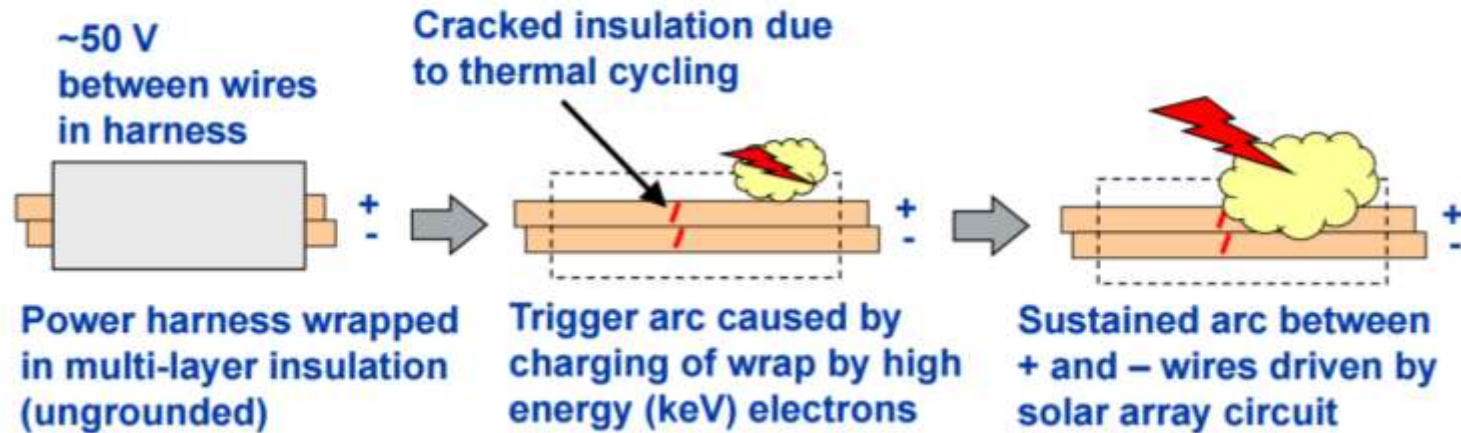

- Satellite passed through auroral region when high energy (keV) flux was 2 orders of magnitude higher than normal resulting in significant charging of multi-layer insulation
- Arcing resulted in pyrolyzed wires, destruction of wire harness and significant loss of power

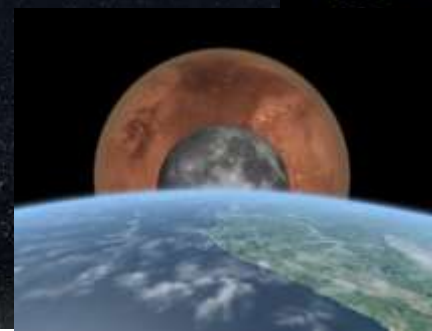

# References and Back-Up



# References

## General spacecraft-charging engineering physics



- ◆ <http://farside.ph.utexas.edu/teaching/plasma/lectures/node1.html>
  - ◆ <http://holbert.faculty.asu.edu/eee560/spc-chrg.html>
  - ◆ <http://www.spervis.oma.be/help/background/background.html>
  - ◆ <http://see.msfc.nasa.gov/>
  - ◆ [http://see.msfc.nasa.gov/ee/model\\_charging.htm](http://see.msfc.nasa.gov/ee/model_charging.htm)
  - ◆ <http://see.msfc.nasa.gov/ModelDB/iscchsra.htm>
  - ◆ [http://see.msfc.nasa.gov/ee/db\\_chargecollector.htm](http://see.msfc.nasa.gov/ee/db_chargecollector.htm)
  - ◆ [https://descanso.jpl.nasa.gov/SciTechBook/st\\_series3\\_chapter.html](https://descanso.jpl.nasa.gov/SciTechBook/st_series3_chapter.html)
- E. C. Whipple, “Potentials of Surfaces in Space,” Reports on Progress in Physics, Vol. 44, pp. 1197-1250, 1981
  - Garrett, H. B., and A. C. Whittlesey. Guide to Mitigating Spacecraft Charging Effects, John Wiley and Sons, Hoboken, New Jersey, 2010.
  - Lai, S. T. (2011) Fundamentals of Spacecraft Charging: Spacecraft Interactions with Space Plasmas. Princeton, NJ: Princeton University Press.
  - L. J. Herr, M. B. McCollum, Spacecraft Environments Interactions, Protecting Against the Effects of Spacecraft Charging, NASA-RP-1354, National Aeronautics and Space Administration, 1994.
  - Koontz, Steven L., Kramer, Leonard, Mikatariyan, Ronald, Soares, Carlos; “Spacecraft Charging Hazards,” in Safety Design for Space Operations, (Tommaso Sgobba, editor in chief), International Association for the Advancement of Space Safety, Elsevier, Amsterdam, Boston, 2013, pp. 520 – 553.
  - Krause, L. H., D. L. Cooke, C. L. Enloe, G. I. Font, G. F. McHarg, V. Putz, K. P. Ray, and M. J. Toth. (2004) Survey of DSCS-III B-7 differential surface charging. IEEE Transactions on Nuclear Science 51(6): 3399-3407.
  - Garrett, H. B., and A. R. Hoffman. (2000) Comparison of spacecraft charging environments at the Earth, Jupiter and Saturn. IEEE Transactions on Plasma Science 28(6).
  - Garrett, H. B., and A. C. Whittlesey. (2000) Spacecraft charging, an update. IEEE Transactions on Plasma Science 28(6): 2017-2028.
  - Gentile, L. C., W. J. Burke, C. Y. Huang, J. S. Machuzak, D. A. Hardy, D. G. Olson, B. E. Gilchrist, J.-P. Lebreton, and C. Bonifazi. (1998) Negative shuttle charging during TSS 1R. Geophysical Research Letters 25(4): 433-436.
  - Jean-Pierre Catani, Denis Payan; “Electrostatic behavior of materials in a charging space environment,” Centre National d'Etudes Spatiales, 18, avenue Edouard-Belin, 1401 TOULOUSE CEDEX 4 - Proceedings of the 9th International Symposium on Materials in a Space Environment, 16-20 June 2003, Noordwijk, The Netherlands. Compiled by K. Fletcher. ESA SP-540, Noordwijk, Netherlands: ESA Publications Division, ISBN 92-9092-850-6, 2003, p. 3 – 16.
  - Mak Tafazoli; “A study of on-orbit spacecraft failures,” Acta Astronautica, Volume 64, Issues 2–3, 2009, 195–205.



# References

## Standards and Guidelines

- NASA TECHNICAL HANDBOOK NASA-HDBK-4006 National Aeronautics and Space Administration Approved: 06-03-2007
- NASA TECHNICAL STANDARD NASA-STD-4005 National Aeronautics and Space Administration Approved: 06-03-2007
- NASA TECHNICAL HANDBOOK NASA-HDBK-4002 National Aeronautics and Space Administration Approved: 02-17-1999
- <http://www.nasa.gov/offices/oce/lis/0797.html>
- NASA Preferred Practice PD-ED-1210 - [http://www.klabs.org/DEI/References/design\\_guidelines/design\\_series/1210.pdf](http://www.klabs.org/DEI/References/design_guidelines/design_series/1210.pdf)
- **All ISS Program Grounding Bonding and EMI/EMC Requirements Documents – This is not LEO specific and should be applicable to cis-lunar and interplanetary programs with limited modifications**
- Department of Defense. (2007) Requirements for the Control of Electromagnetic Interference Characteristics of Subsystems and Equipment. MIL-STD-461F. Washington, DC: Department of Defense.
- Department of Defense. (1987) Electromagnetic Compatibility Requirements for Space Systems. MIL-STD-1541A. Washington, DC: Department of Defense.
- National Aeronautics and Space Administration. (1999) Avoiding Problems Caused by Spacecraft On-Orbit Internal Charging Effects. NASA Technical Standards Program Document NASA-HDBK-4002. Pasadena, CA: National Aeronautics and Space Administration, Jet Propulsion Laboratory.
- National Aeronautics and Space Administration. (2007) Low Earth Orbit Spacecraft Charging Design Handbook. NASA Technical Standards Program Document NASA-HDBK-4006. Washington, DC: National Aeronautics and Space Administration, NASA Headquarters.
- National Aeronautics and Space Administration. (1984) Design Guidelines for Assessing and Controlling Spacecraft Charging Effects. NASA Technical Paper NASA TP-2631. Cleveland, OH: National Aeronautics and Space Administration, Lewis Research Center.
- European Space Agency. (2008) Space Engineering, Spacecraft Charging Standard, European Cooperation for Space Standardization. ECSS-E-ST-20-06C. European Co-operation for Space Standardization, European Space Agency.



# References

## cislunar spacecraft charging

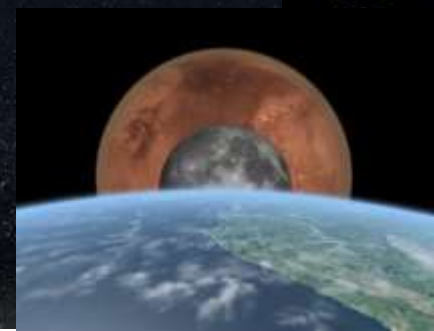

- Stubbs, T. J., J. S. Halekas, W. M. Farrell, and R. R. Vondrak. (2007) Lunar surface charging: a global perspective using Lunar Prospector data. Proceedings of the Dust in Planetary Systems Conference, Kauai, HA: European Space Agency.
- Halekas, J. S., R. P. Lin, and D. L. Mitchell. (2005) Large negative lunar surface potentials in sunlight and shadow. Geophysical Research Letters 32: L09102, doi:10.1029/2005GL022627.
- Halekas, J. S., G. T. Delory, D. A. Brain, R. P. Lin, M. O. Fillingim, C. O. Lee, R. A. Mewaldt, T. J. Stubbs, W. M. Farrell, and M. K. Hudson. (2007) Extreme lunar surface charging during solar energetic particle events. Geophysical Research Letters 34: L02111, doi:10.1029/2006GL028517.
- [http://themis.igpp.ucla.edu/events/Fall2011SWG/Poppe\\_ARTEMIS\\_Sep2011.pdf](http://themis.igpp.ucla.edu/events/Fall2011SWG/Poppe_ARTEMIS_Sep2011.pdf)
- [http://artemis.igpp.ucla.edu/nuggets/nuggets\\_2011/Halekas\\_1/halekas\\_11.html](http://artemis.igpp.ucla.edu/nuggets/nuggets_2011/Halekas_1/halekas_11.html)
- [Winslow, Stubbs, Halekas, et al - Lunar surface charging... https://www.hou.usra.edu/meetings/lpsc2015/pdf/1261.pdf](https://www.hou.usra.edu/meetings/lpsc2015/pdf/1261.pdf)
- Lunar prospector – J. S. Halekas et al, JOURNAL OF GEOPHYSICAL RESEARCH, VOL. 114, A05110, doi:10.1029/2009JA014113, 2009.
- Artemis – J. S. Halekas et al, JOURNAL OF GEOPHYSICAL RESEARCH, VOL. 116, A07103, doi:10.1029/2011JA016542, 2011.

# Spacecraft Failure Breakdown: 156 Failures 1980 – 2005 Mostly not “Environments”

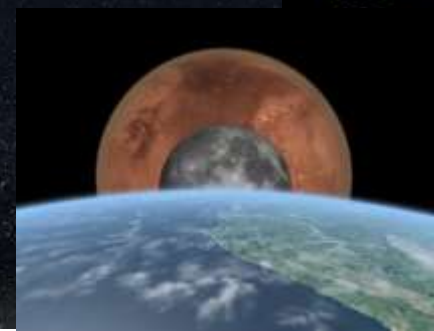

Mak Tafazoli; “A study of on-orbit spacecraft failures,” Acta Astronautica, Volume 64, Issues 2–3, 2009, 195–205

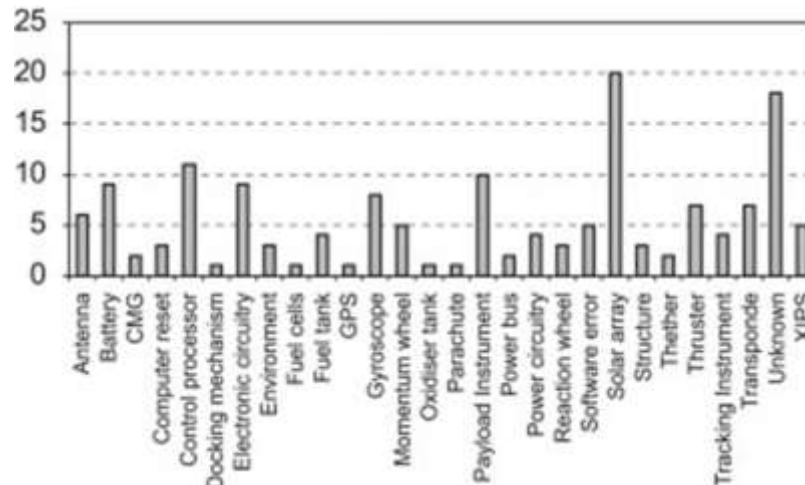
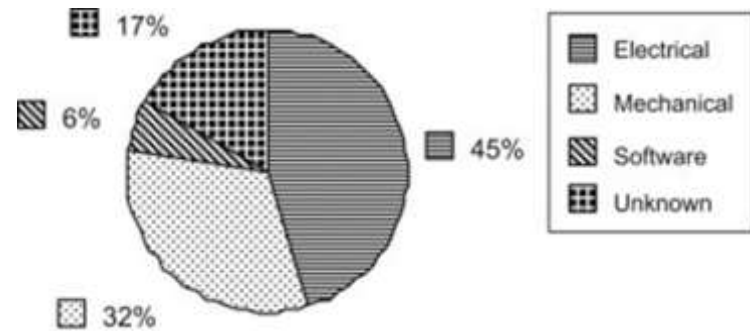
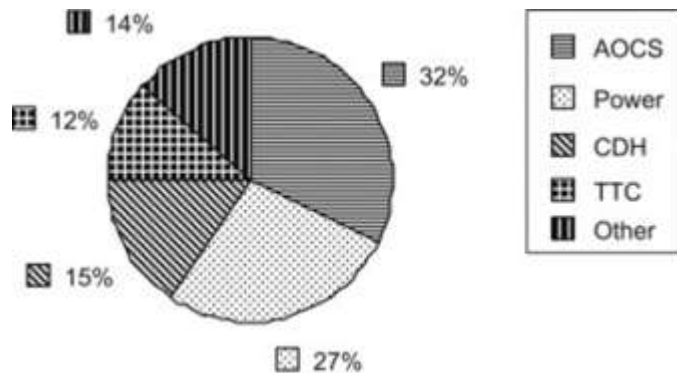





# Spacecraft-charging material properties

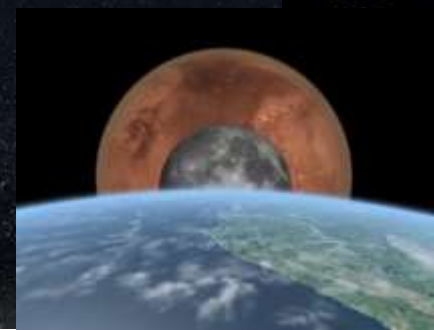

Parameter/ Material (units)	Relative Dielectric Constant <sup>2</sup>	Dielectric Strength <sup>3</sup> (V/mil @ mil)	DC Volume Resistivity (Ω-cm) <sup>4</sup>	Density (g/cm <sup>3</sup> )/ density in relation to aluminum	Time Constant <sup>5</sup> (as noted)
Ceramic (Al <sub>2</sub> O <sub>3</sub> )	8.8	340 @125	>10 <sup>12</sup>	2.2/0.81	>0.78 s
Delrin®	3.5	380 @ 125	10 <sup>15</sup>	1.42/0.52	310 s (5.2 min)
FR4	4.7	420 @ 62	>4 × 10 <sup>14</sup>	1.78/0.66	>141 s
Kapton®	3.4	7000 @ 1	~10 <sup>18</sup> to 10 <sup>19</sup>	1.4/0.51	3.5 d
Kapton®	--	580 @ 125	~10 <sup>18</sup> to 10 <sup>19</sup>	1.4/0.51	3.5 d
Mylar®	3	7000 @ 1	10 <sup>18</sup>	1.4/0.51	3.1 d
Polystyrene	2.5	5000 @ 1	10 <sup>16</sup>	1.05/0.39	37 min
Quartz, fused	3.78	410 @ 250	>10 <sup>19</sup>	>2.6	>38 d
Teflon® (generic) <sup>6</sup>	2.1	2-5k @ 1	~10 <sup>18</sup> to 10 <sup>19</sup>	2.1/0.78	2.1 d
Teflon® (generic) <sup>6</sup>	--	500 @ 125	~10 <sup>18</sup> to 10 <sup>19</sup>	2.1/0.78	2.1 d

(Blank lines below are for reader's notes and additions.)

**Notes:**

1. If the numbers in the table are "greater than," the actual time constants could be greater than shown (calculated) in this table. The numbers in this table are for room temperature. At low temperatures, the resistivity values may become much greater and the time constants for charge bleed-off can be much greater.
2. Permittivity (dielectric constant) = relative dielectric constant × 8.85 × 10<sup>-12</sup> F/m.
3. ~508 V/mil is the same as 2 × 10<sup>7</sup> V/m.
4. Resistivity (Ω-m) = resistivity (Ω-cm)/100.
5. Time constant (s) = permittivity (F/m) × resistivity (Ω-m).
6. Generic numbers for Teflon®. Polytetrafluoroethylene ((PTFE) (Teflon®)) and fluorinated ethylene propylene (Teflon® FEP) are common forms in use for spacecraft.

Parameter/ Material Units	DC Volume Resistivity (Ω-cm (x10 <sup>-6</sup> ))	DC Volume Resistivity (relative to Al)	Density (g/cm <sup>3</sup> )	Density (relative to Al)
Aluminum	2.62	1	2.7	1
Aluminum Honeycomb	Variable	Variable	-0.049	-0.02
Brass (70-30)	3.9	1.49	8.5	3.15
Carbon graphite	5-30	1.9-11.45	1.3-1.95	0.48-0.72
Copper	1.8	0.69	8.9	3.3
Graphite-epoxy	Variable	Variable	1.5	0.56
Gold	2.44	0.93	19.3	7.15
Invar	81	30.9	8.1	3
Iron-steel	9-90	3.43-34.3	7.87	2.91
Lead	98	37.4	11.34	4.2
Kovar A	284	108.4	~7.8	~2.89
Nickel	7.8	2.98	8.9	3.3
Magnesium	4.46	1.7	1.74	0.64
Silver	1.6	0.61	10.5	3.89
Stainless steel	90	34.35	7.7	2.85
Tantalum	13.9	5.3	16.6	6.15
Titanium	48	18.3	4.51	1.67
Tungsten	5.6	2.14	18.8	6.96

(Blank lines below are for reader's notes and additions.)

**Notes:**

1. See text for references and accuracies.
2. Densities from various sources match well, resistivities may vary.
3. Resistivity (Ω-m) = resistivity (Ω-cm)/100.



# Spacecraft-charging material properties



## Some recommended materials

Material	Comments
Paint (carbon black)	Work with manufacturer to obtain paint that satisfies ESD conductivity requirements of Section 3.2.2 and thermal, adhesion, radiation tolerance, and other needs.
GSFC NS43 paint (yellow)	Has been used in some applications where surface potentials are not a problem; apparently will not discharge.
ITO (250 nm)	Can be used where some degree of transparency is needed; must be properly grounded. For use on solar cells, optical solar reflectors, and Kapton® film, use sputtered method of application and not vapor deposited.
Zinc orthotitanate paint (white ZOT)	Possibly the most conductive white paint; adhesion difficult without careful attention to application procedures, and then difficult to remove.
Alodyne	Conductive conversion coatings for magnesium, aluminum, etc., are acceptable.
DuPont Kapton® XC family	Carbon-filled polyimide films; 100XC10E7 with nominal resistivity of $2.5 \times 10^4 \Omega\text{-cm}$ ; not good in atomic oxygen environment without protective layer (ITO, for example).
Deposited conductors	Examples: aluminum, gold, silver, Inconel® on Kapton®, Teflon®, Mylar®, and fused silica.
Conductive paints	Over dielectric surfaces, with some means to assure bleed-off of charge.
Carbon-filled Teflon® or Kapton®	Carbon filler helps make the material conductive.
Conductive adhesives	Especially if needed for bridging between a conductor and ground.
Conductive surface materials	Graphite epoxy (scuffed to expose carbon fibers) or metal.
Etched metal grids	Etched or bonded to dielectric surfaces; frequent enough to have surface appear to be grounded.
Aluminum foil or metalized plastic film tapes	If they can be tolerated for other reasons such as thermal behavior.

## Some materials to avoid (if you can)

MATERIAL	COMMENTS
Anodyze	Anodizing produces a high-resistivity surface to be avoided for ESD applications. The coating can be made quite thin and might be acceptable if analysis shows stored energy is small.
Fiberglass material	Resistivity is too high and is worse at low temperatures.
Paint (white)	In general, unless a white paint is measured to be acceptable, it is unacceptable.
Mylar® (uncoated)	Resistivity is too high.
Teflon® (uncoated)	Resistivity is too high. Teflon® has demonstrated long-time charge storage ability and causes catastrophic discharges.
Kapton® (uncoated)	Generally unacceptable because of high resistivity; however, in continuous sunlight applications if less than 0.13 mm (5 mil) thick, Kapton® is sufficiently photoconductive for use.
Silica cloth	Has been used for antenna radomes. It is a dielectric, but because of numerous fibers or if used with embedded conductive materials, ESD sparks may be individually small. It has particulate issues, however.
Quartz and glass surfaces	It is recognized that solar cell cover slides and second-surface mirrors have no substitutes that are ESD acceptable; they can be ITO coated with minor performance degradation, and the ITO must be grounded to chassis. Their use must be analyzed and ESD tests performed to determine their effect on neighboring electronics. Be aware that low temperatures significantly increase the resistivity of glasses [3].

# Martian Ionosphere: Altitude Profiles: day and night sides.

## ESA – Mars Express

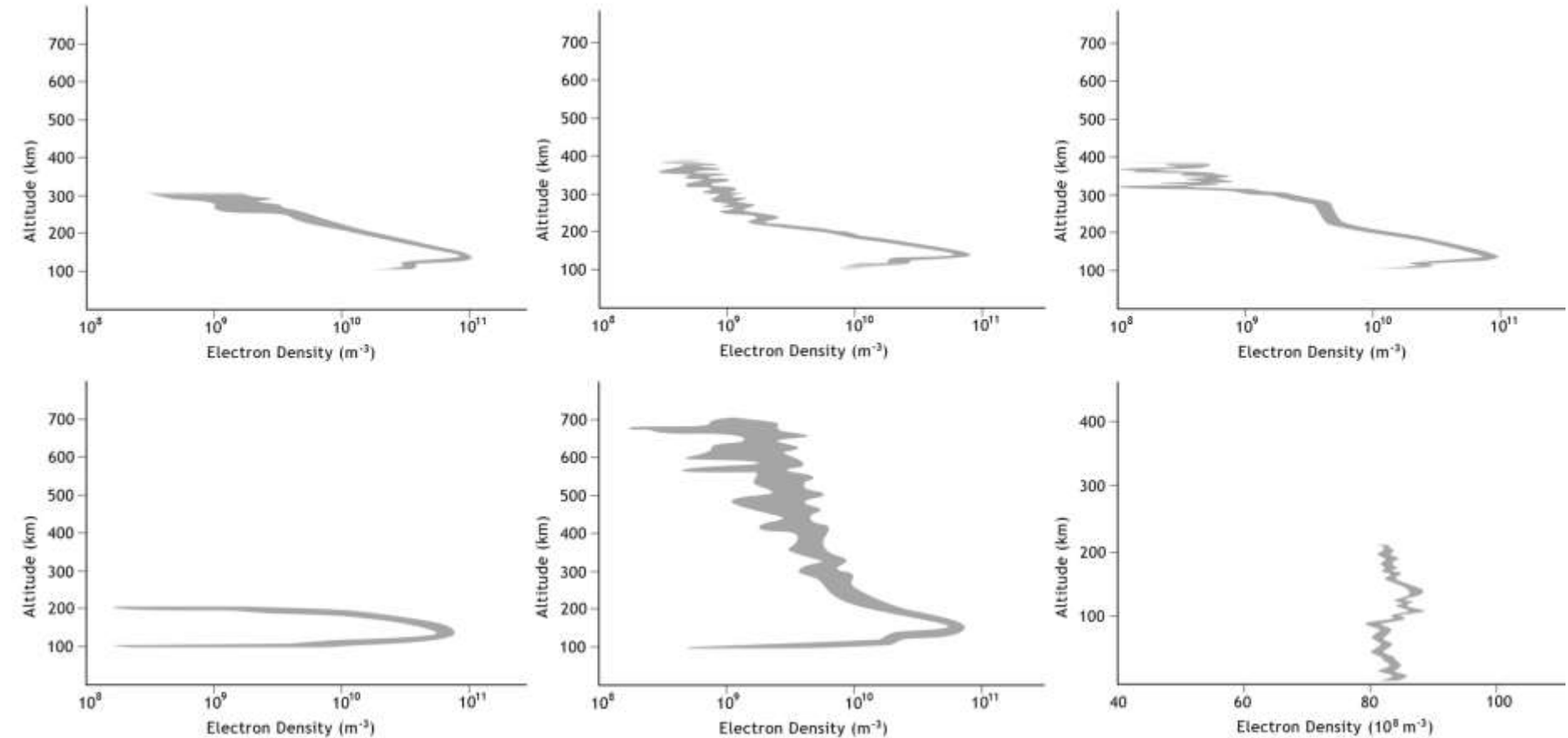
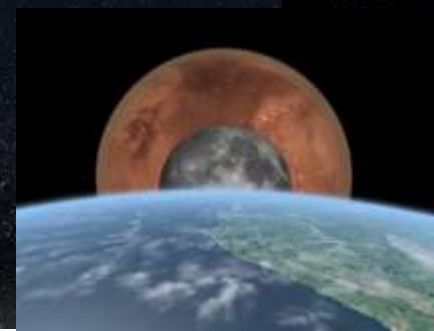

<http://sci.esa.int/mars-express/51106-dayside-and-night-side-profiles-of-the-martian-ionosphere/>

# Venus' Ionosphere: Altitude Profiles

## ESA – Venus Express Radio Science

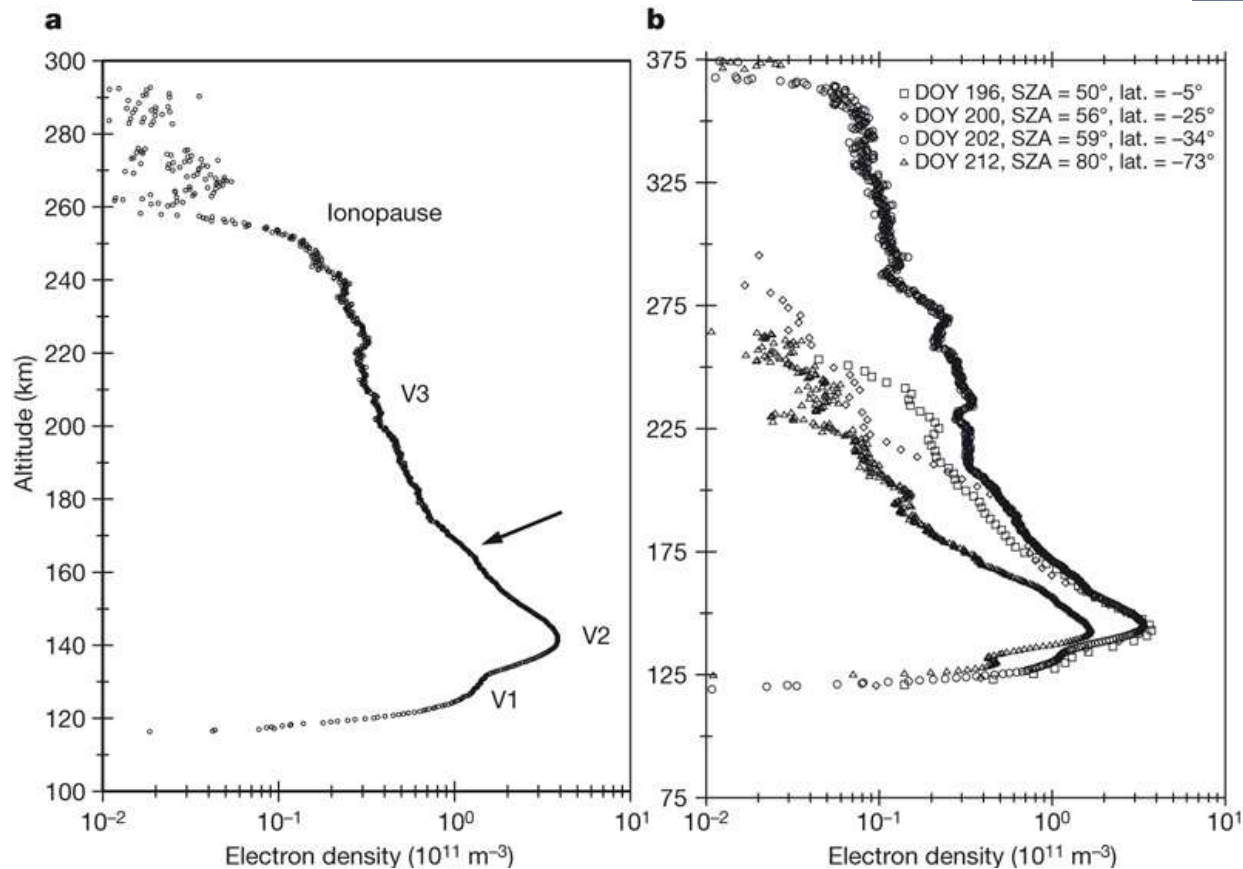
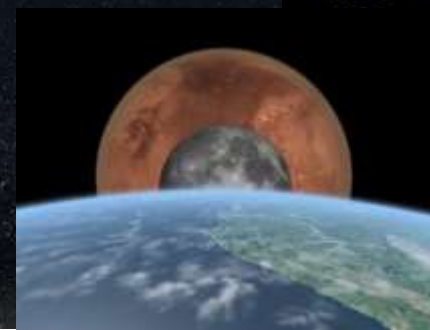

The structure of Venus' middle atmosphere and ionosphere

M. Pätzold, B. Häusler, M. K. Bird, S. Tellmann, R. Mattei, S. W. Asmar, V. Dehant, W. Eidel, T. Imamura, R. A. Simpson & G. L. Tyler  
Nature 450, 657-660(29 November 2007)

doi:10.1038/nature06239

# Earth's Ionosphere: Altitude Profile and Geography

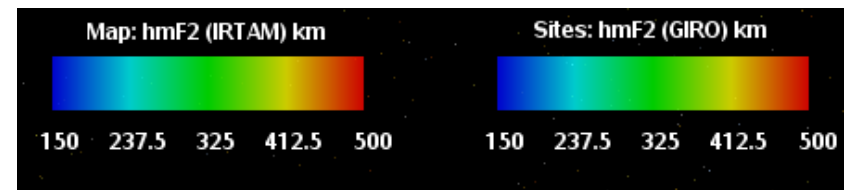
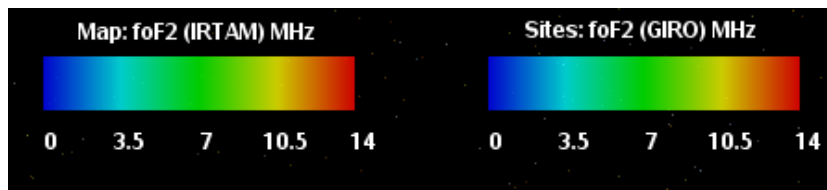
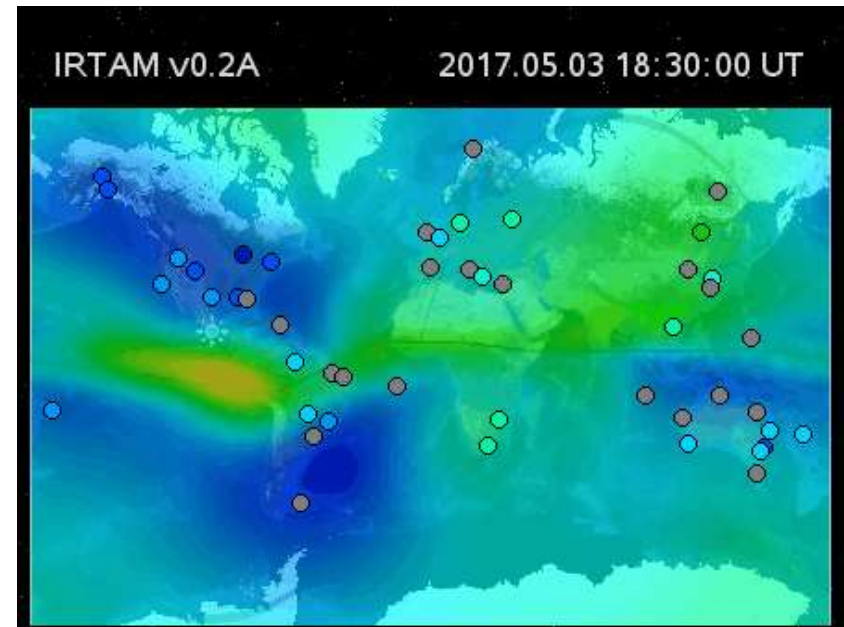
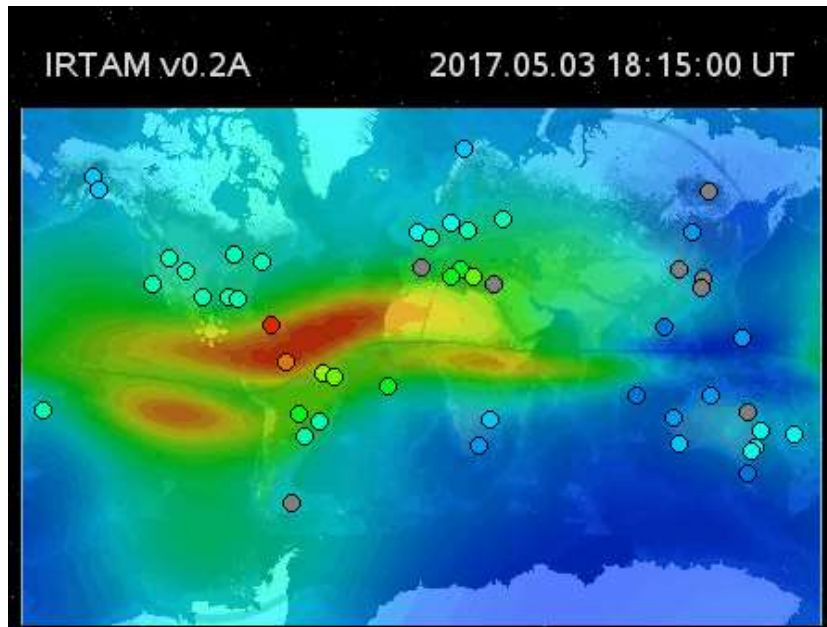
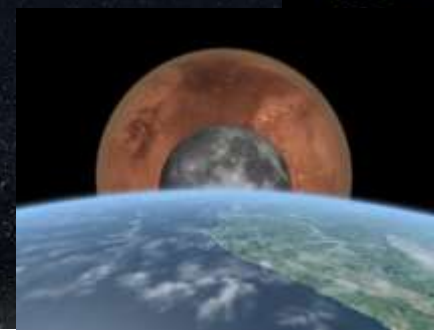

<http://giro.uml.edu/IRTAM/>

# Earth's Ionosphere: Altitude Profile

<http://www.haystack.edu/obs/mhr/index.html>

Millstone Hill Radar Model Ionosphere

03-May-2017 14:47:53

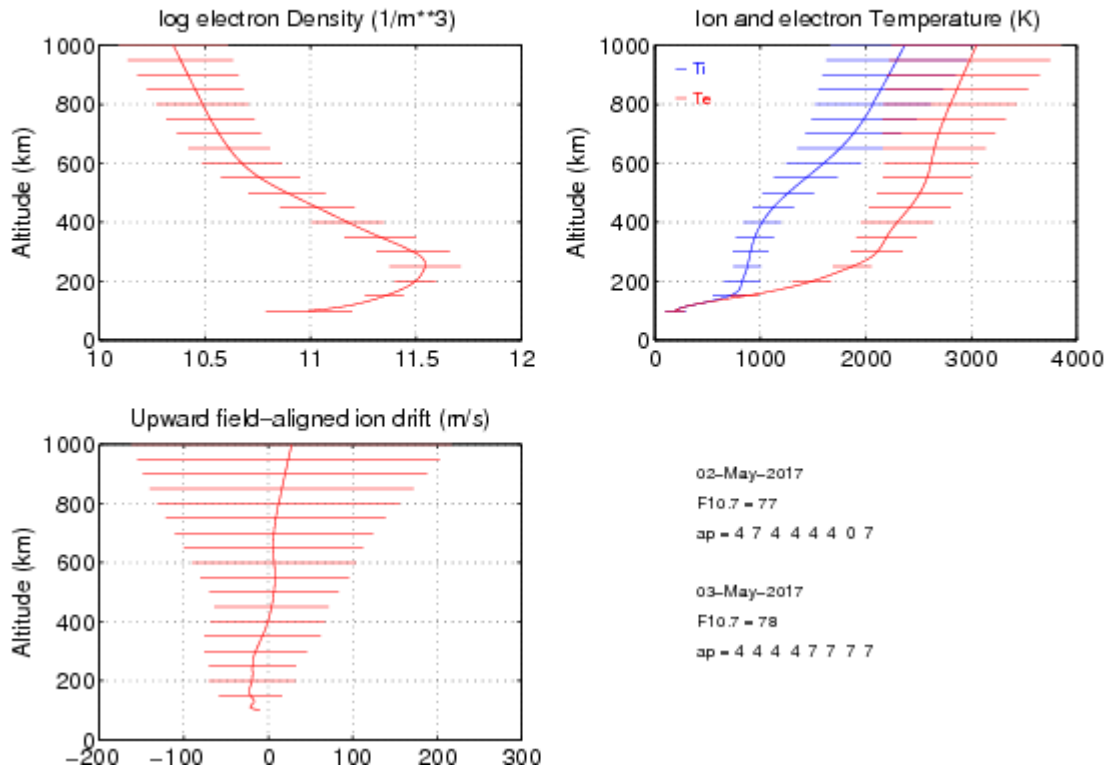

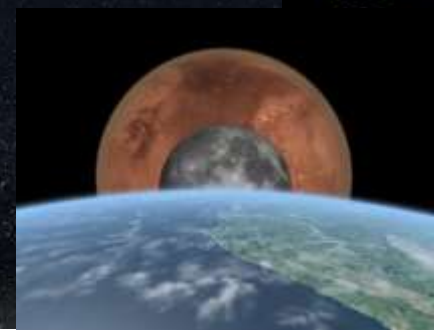

# FPMU on ISS

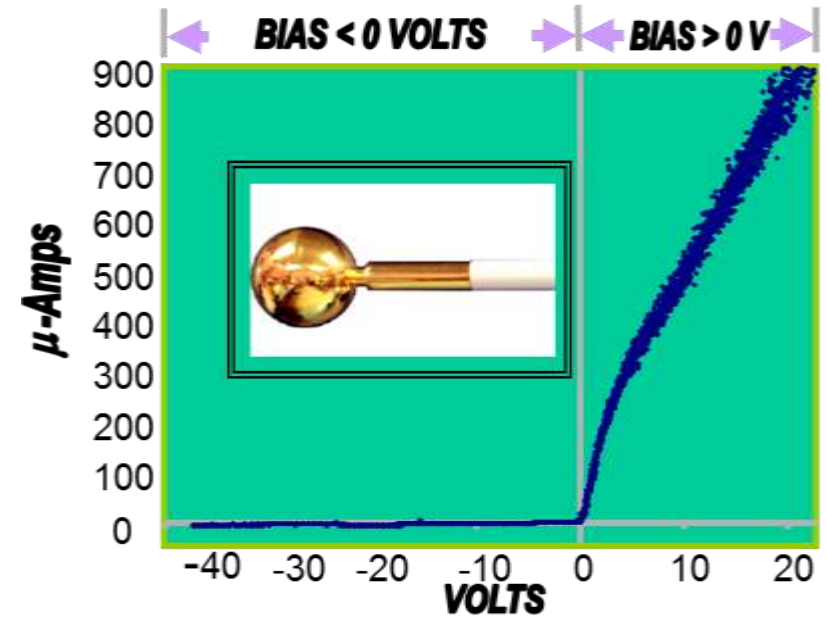
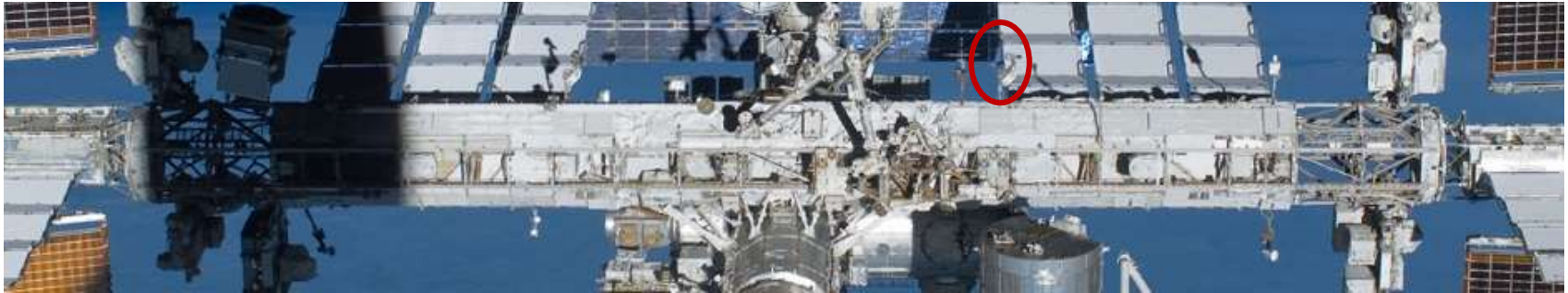

# ISS Charging Measurements: FPMU vs. Boeing Plasma Interaction Model - 2007 to 2013

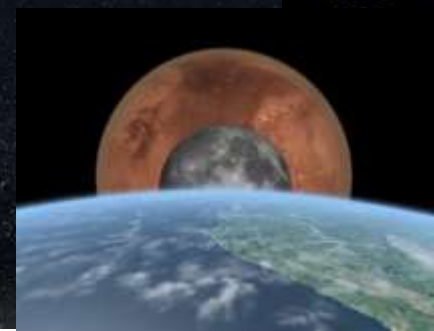

These points are associated with a phenomena that we call “rapid increase in potential or rapid charging peaks”. These events have a duration of 2 to 3 seconds or less and do not contribute significantly to the EVA shock hazard.

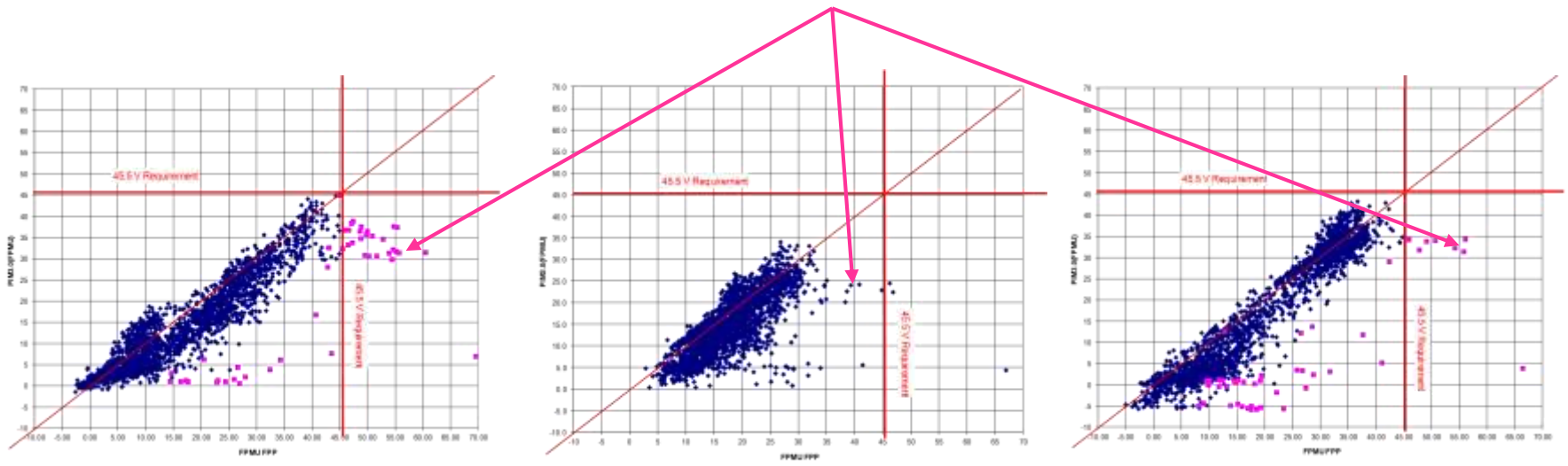

**PORT TRUSS TIP, Scatter Plot 2007-188 to 2013-105**

**Scatter Plot at FPMU Location, 2007-188 to 2013-105 (2328 points)**

**STARBOARD TRUSS TIP, Scatter Plot, 2007-188 to 2013-105**

Final SSPCB approval of ISS EVA shock hazard management plan

[https://iss-www.jsc.nasa.gov/nwo/ppco/cbp\\_sscb/bbt\\_docs/bbtcal/Agenda.6.20-Oct-2015.htm](https://iss-www.jsc.nasa.gov/nwo/ppco/cbp_sscb/bbt_docs/bbtcal/Agenda.6.20-Oct-2015.htm)



# A Simple Worked Example: Solar Array Driven Charging in LEO (~ ISS)

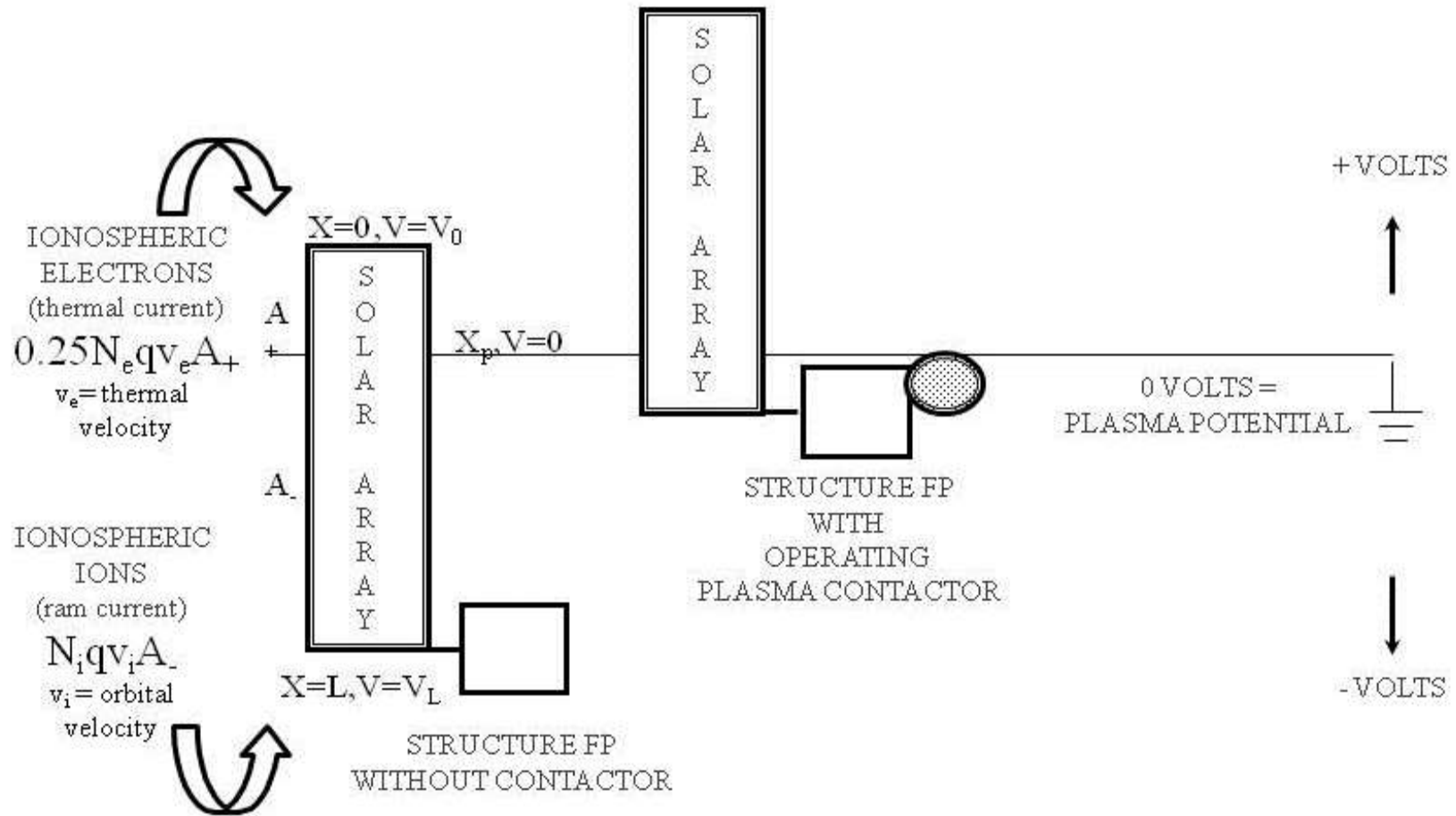
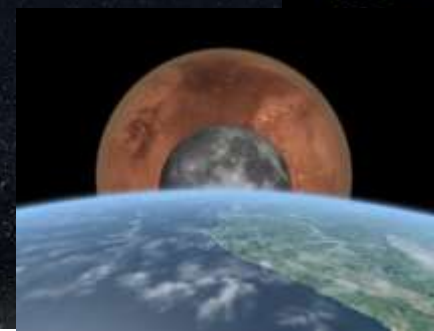

# Acronyms and Abbreviations

• ADEOS	Advanced Earth Observation Satellite	• km	kilometer
• ATK	Alliant Techsystems, Inc.	• L	length
• C&DH	Command and Data Handling	• LEO	low Earth orbit
• cm	centimeter	• MeV	mega electron volt
• CNOFS	Communications and Navigation Outage forecast Satellite	• MLI	multi layer insulation
• C&T	communications & tracking	• MM/OD	micrometeoroid/orbital debris
• DMSP	Defense Meteorological Satellite Program	• MPCV	Multi Purpose Crew Vehicle (Orion)
• DoD	Department of Defense	• Ne	electron density
• DSCS	Defense Services Communications Satellite	• NOAA	National Oceanic and Atmospheric Administration
• EM	electromagnetic	• PCU	Plasma Contactor Unit
• EMC	electromagnetic compatibility	• PEO	Polar Earth Orbit
• EMF	electromagnetic force	• PIM	Plasma Interaction Model
• EMI	electromagnetic interference	• POR	Power on Reset
• EPS	Electrical Power System	• PTCS	Passive Thermal Control Surface
• ESA	European Space Agency	• PV	Photovoltaic
• ESD	electrostatic discharge	• RF	radio frequency
• EURECA	European Retrievable Carrier	• SM	Service Module
• EVA	extravehicular activity	• SPE	Solar Particle Event
• FP	floating potential	• SPRT	System Problem Resolution Team
• FPMU	Floating Potential Measurement Unit	• UARS	Upper Atmospheric Research Satellite
• GEO	Geosynchronous/Geostationary orbit	• USAF	United States Air Force
• GN&C	guidance, navigation, and control	• UT	universal time
• GSFC	Goddard Space Flight Center	• UV	Ultraviolet Light
• HTV	H-II Transfer Vehicle	• V	volt
• ISS	International Space Station	• VASMIR	Variable Specific Impulse Magnetoplasma Rocket
• ITO	indium tin oxide		
• JAXA	Japan Aerospace Exploration Agency		
• JPL	Jet Propulsion Laboratory		
• keV	kilo electron volt		