



# Aerodynamic Testing, Analysis, & Modeling of Powered-Lift

Craig Hange

From VTOL to eVTOL Workshop

May 24, 2018

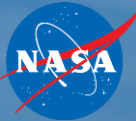

# Outline

- Powered-lift for VTOL flight (Non-Rotary Wing)
- Some of the past projects, programs, and facilities at Ames that we have used in VTOL / STOL research. Some of the multi-disciplinary research
  - Aircraft Flight Testing - The X-14A, the Augmentor Wing Jet STOL Research Aircraft (AWJSRA), Quiet Short - Haul Research Aircraft (QSRA), and V/STOL Systems Research Aircraft (VSRA)
  - Wind Tunnels Tests at The National Full-Scale Aerodynamics Complex (NFAC) including the 40 X 80 Foot Wind Tunnel, 80 X 120 Foot Wind Tunnel and Outdoor Aerodynamic Research Facility
  - CFD - The “From Computation to Flight” the Computational Approach to Aeronautics Research
  - Vehicle / Airspace / Environment Integration
- Summary, future work, and take away points

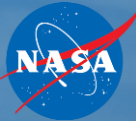

## Powered-Lift for VTOL Flight

- Flight regime of “powered-lift” for VTOL applications.
  - Size and velocity of the flow field
    - ‘High’ disc loading. Low mass flow with high kinetic energy
  - Vehicles with propulsion systems comprising of direct jets, ducted fans, or augmented jets
  - In-ground-effect and out-of-ground effect show distinct and different flow field characteristics
  - A flow field whose “average” dynamic pressure ( $q$ ) may not be relevant
  - Mission profile: Hover, transition, **cruise**, transition, and back to hover
- It is understood that using electric power changes many of the issues, especially hot gas ingestion, but most aerodynamic characteristics remain relevant
- “Are you sure you need to hover during take-off and landing?”
  - Please consider “Short” Take-Off and Landing (STOL)

# VTOL 'Wheel'

- A wheel of (mis)fortune
  - Technically, vehicles were flown successfully
  - 'Misfortune' is due to program issues and failure to identify real requirements
    - Almost always found a 5,000 foot runway somewhere to fly in and out was cheaper than hovering
  - The technology is worthy of revisiting due to:
    - Electric Propulsion
    - Control Systems including Autonomy
    - Advances in CFD, flow modeling, vehicle structural design process
    - Missions have 'true' need to hover

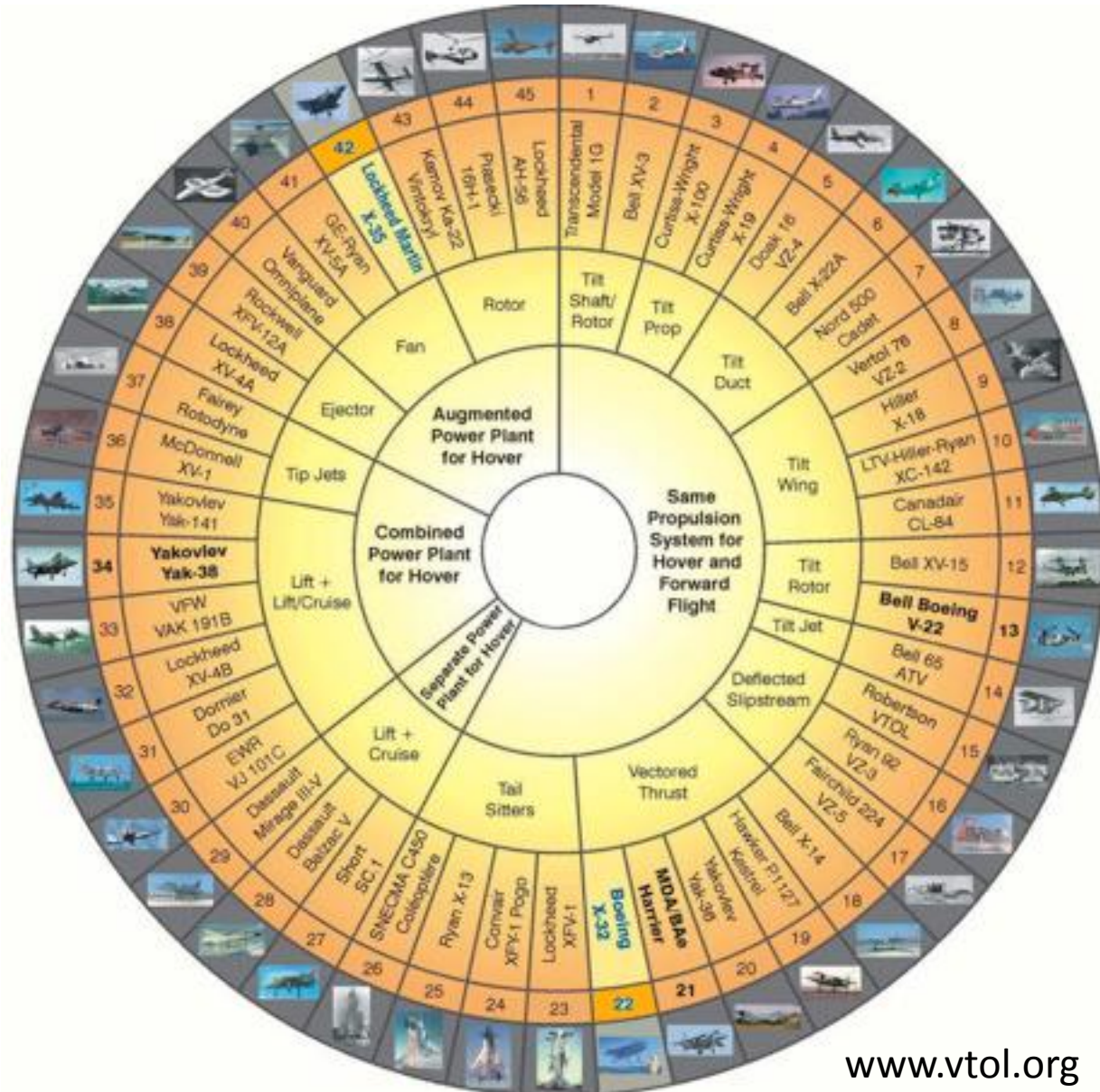

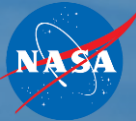

# VTOL Flow Field – Effects

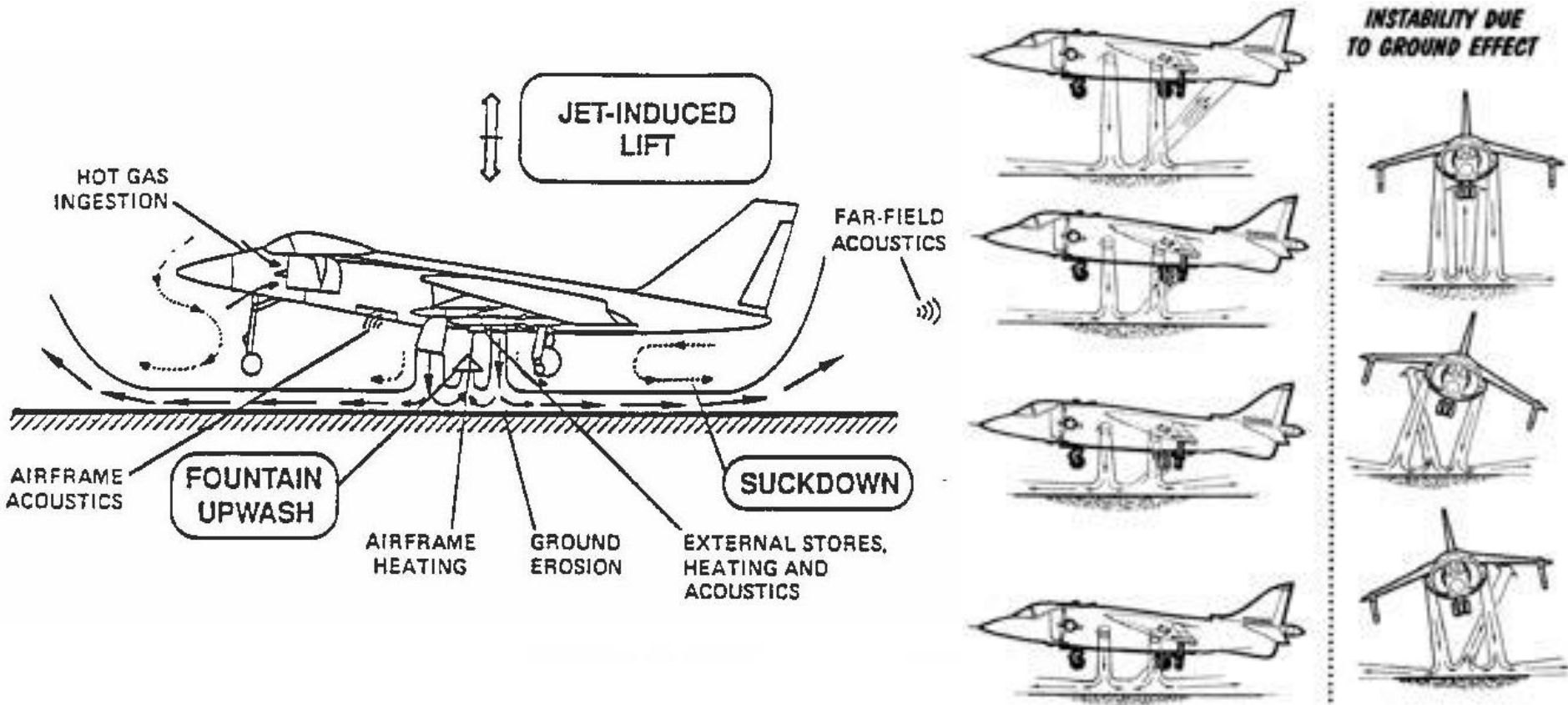

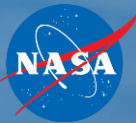

## The Ames VTOL / STOL Projects of the Past

- Some of them even before my time



From VTOL to eVTOL Workshop, May 24, 2018

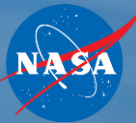

## A History of Ames in VTOL

- The X-14A
  - Flew from 1958 until 1981
  - Helped to provide understanding of jet-borne hover, including the Apollo lunar lander



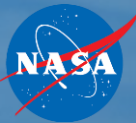

# The Augmentor Wing and Quiet Short Haul Research Aircraft





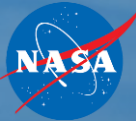

## A History of Ames in VTOL

- The Augmentor Wing STOL Research Aircraft

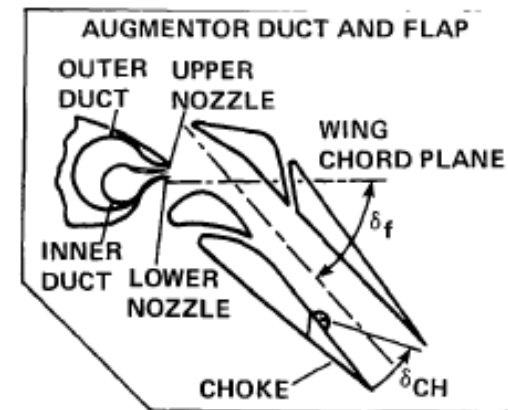
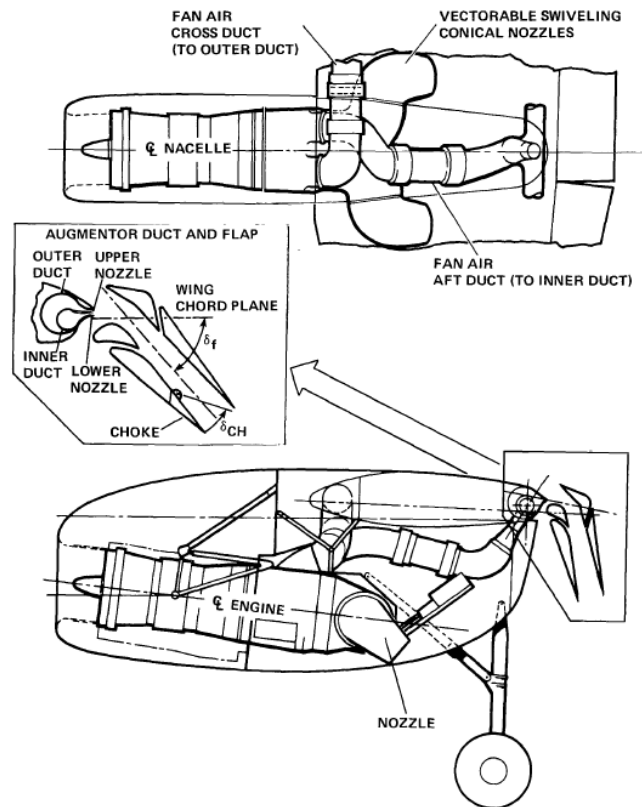

Note the use of the choke flap to facilitate high frequency lift and roll response. It could create drag too, and made a lot of noise (a whistle)!

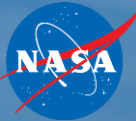

# A History of Ames in VTOL

- The Augmentor Wing STOL Research Aircraft

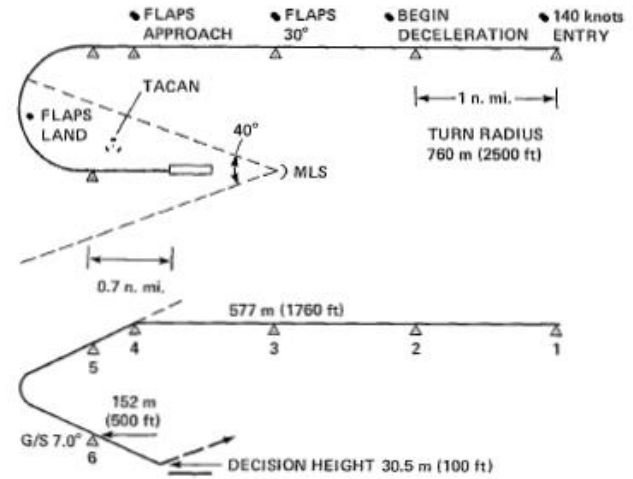
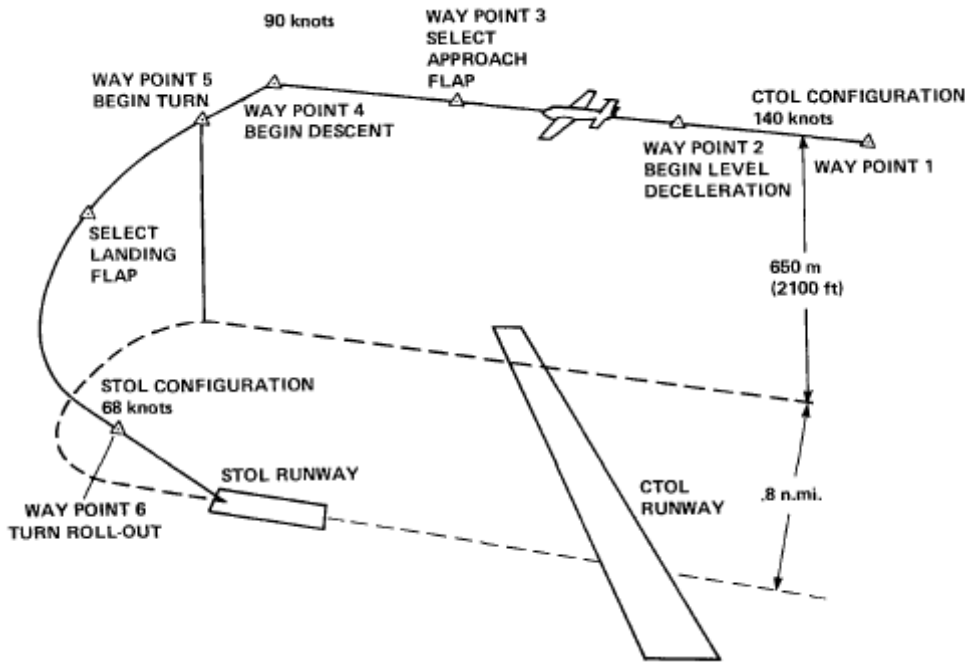

APPROACH SPEED SCHEDULE			
FLAP	WEIGHT, kN	APPROACH, knots	LAND, knots
40	178	95	81
	214		89
50	178	85	73
	214		81
65	178	65	65
	214		73

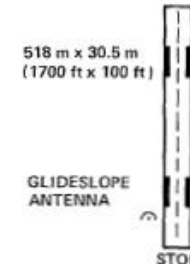

The Curved-Decelerating Descending Approach

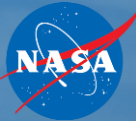

# A History of Ames in VTOL

- The Quiet Short-Haul Research Aircraft

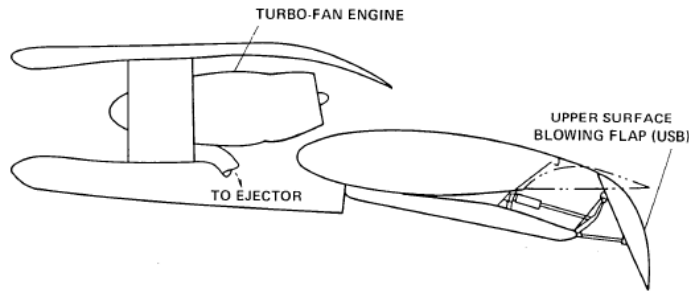

(b) Section through nacelle and USB flap.  
Figure 1.- Quiet Short Haul Research Aircraft.

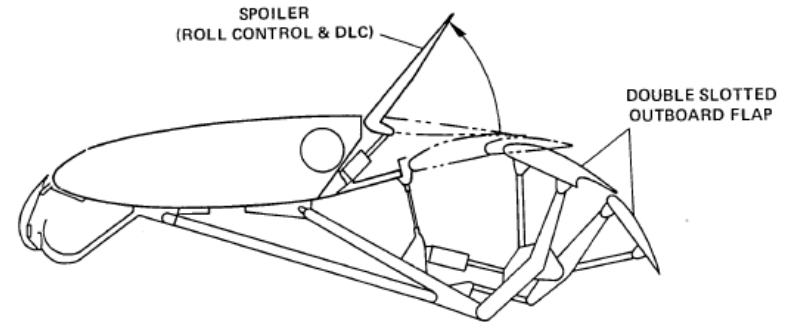

(c) Section through spoiler and outboard flap.

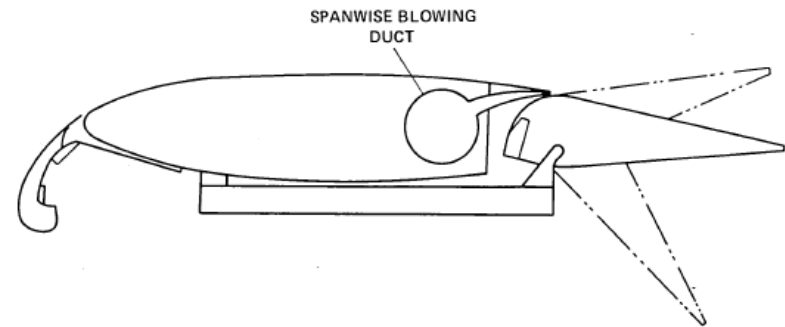

(d) Section through aileron.



# QRSA FLIGHT DEMONSTRATION

(GROSS WEIGHT = 46,000 lb, NO WIND)



## NOISE ABATEMENT DEPARTURE

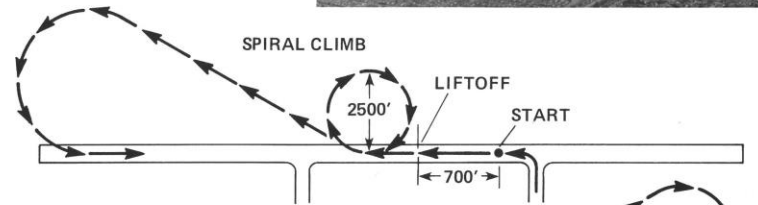

## 2-SEGMENT LANDING APPROACH

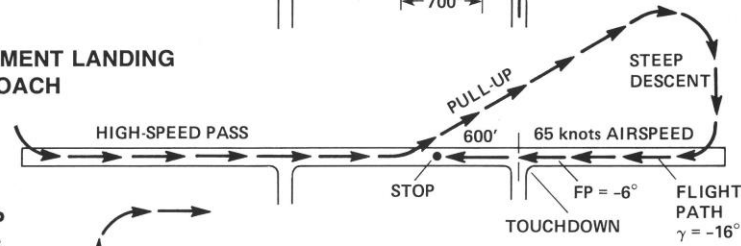

## STEEP CLIMB

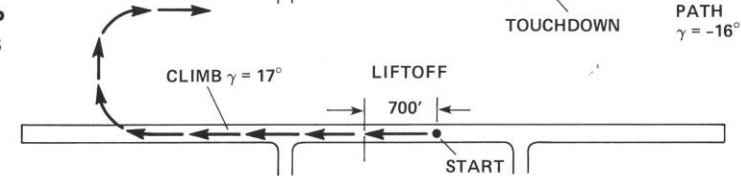

## MANEUVERABILITY

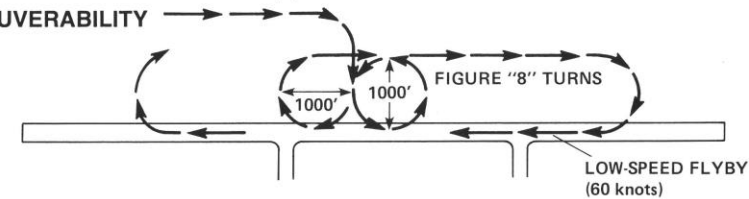

## CLOSE-IN LANDING APPROACH

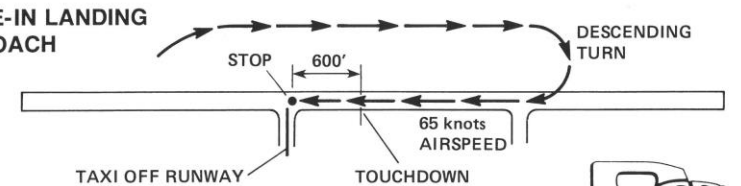

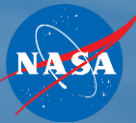

## A History of Ames in VTOL

- The V/STOL Systems Research Aircraft
  - Significant contributions to the JSF (F-35B) program in the area of integrated flight / propulsion controls
  - Ability to test other V/STOL flight control configurations



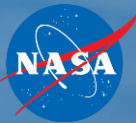

## The 40 X 80 Foot Wind Tunnel

- Early Powered, Powered-Lift Models



Swept Augmentor Wing

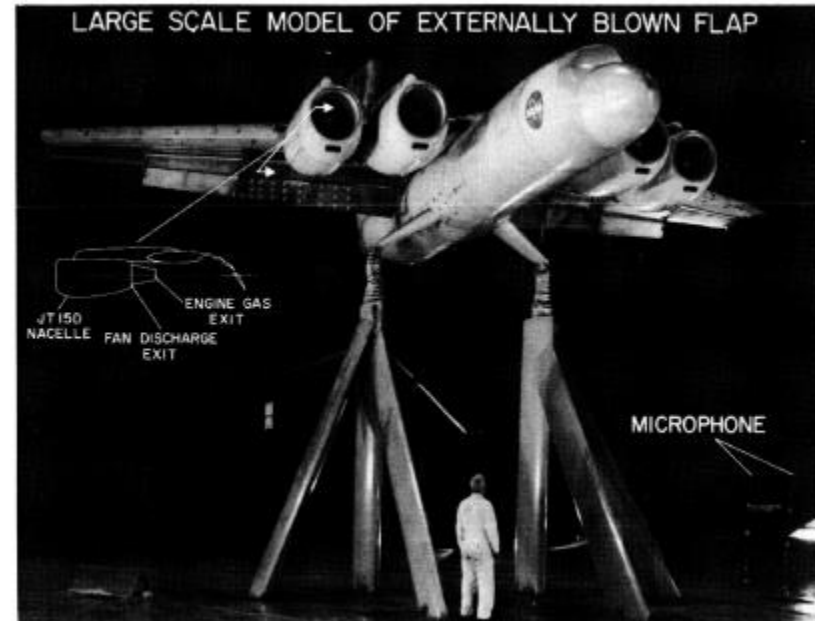

Externally Blown Flap

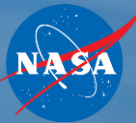

# Avrocar



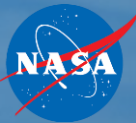

## The 40 X 80 Foot Wind Tunnel

- Early Powered Models

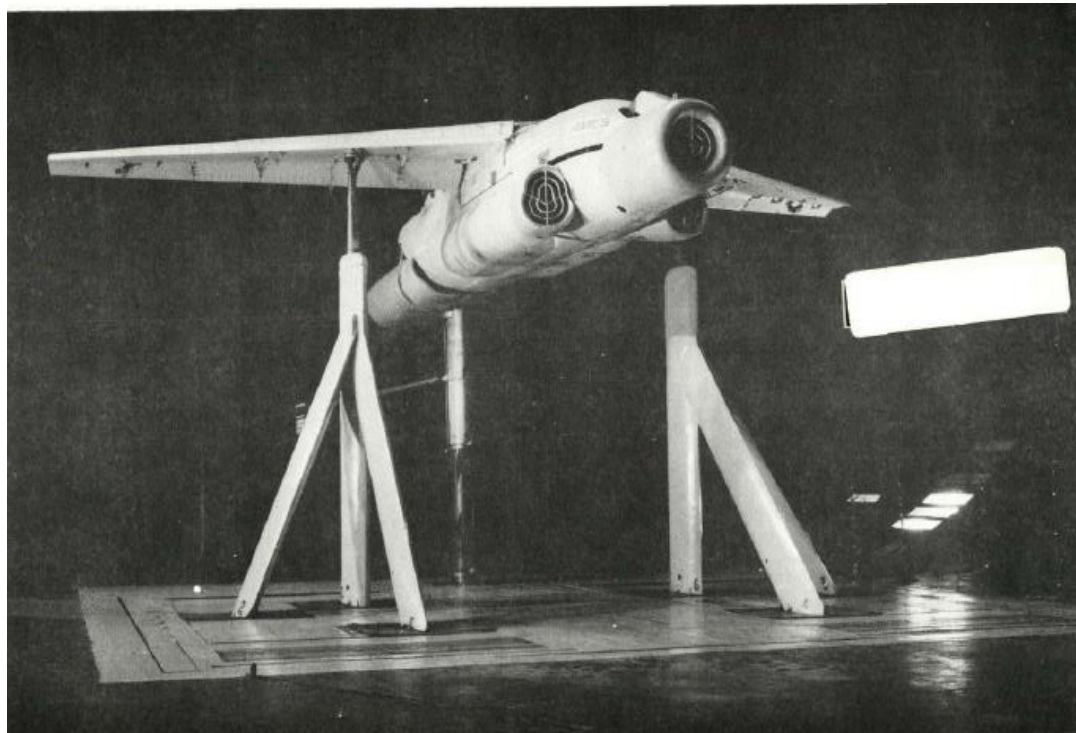

Swept Augmentor Wing Acoustic Suppression Model



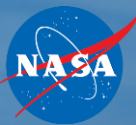

# The 40 X 80 Foot Wind Tunnel

- Full-Scale Powered Models
  - Airspeeds ranging from about 30 knots to almost 300 knots
    - Almost hover conditions, low-speed transition and then high-speed transition through cruise

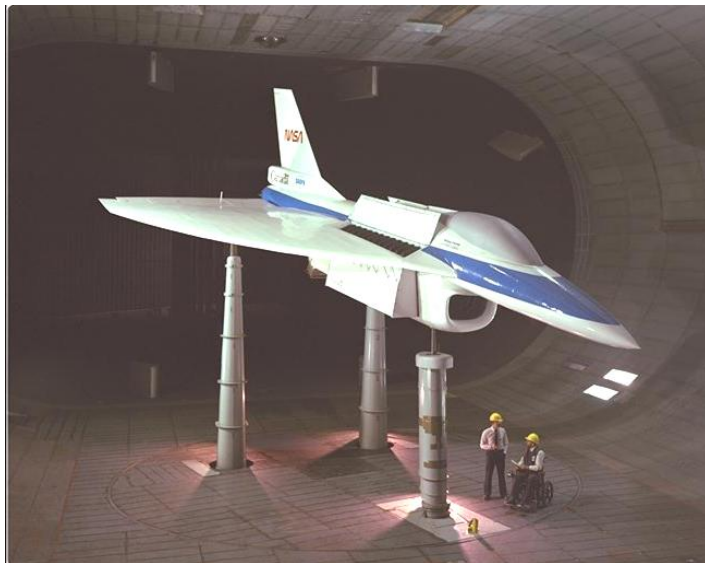

The E-7 Ejector Concept in the Tunnel



The E-7 Ejector Concept Under Construction



## STOL Acoustic Testing in the 40 X 80



- Aerodynamics / Propulsion / Acoustics Integration Tests
- Lockheed Martin S-53 was powered by Williams turbofans
- Cal Poly hybrid wing/powerd-lift model was powered by TPS (high pressure air)

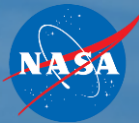

## Small-Scale Testing in the Full-Scale Facility

- Consider small-scale testing in the NFAC if you need large spaces to get unimpeded flow and reduce wall-effects on flow field
- You will want a ground plane, the tunnel's boundary layer is too big

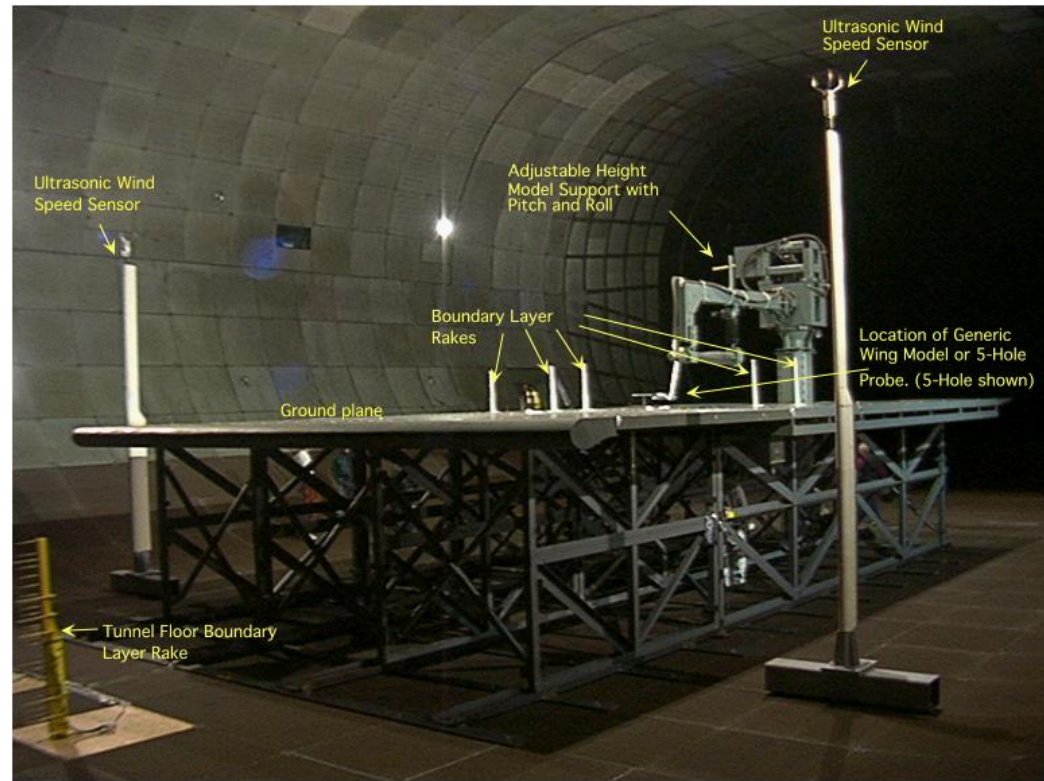

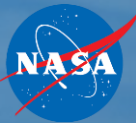

## Small-Scale Testing in the Full-Scale Facility

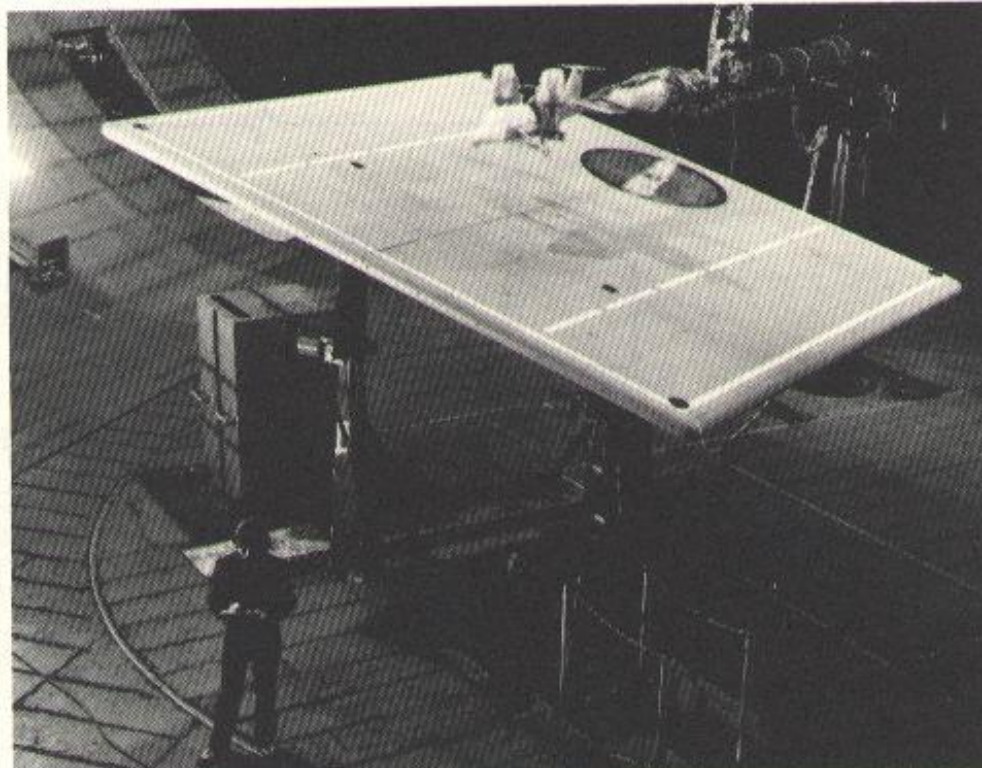

Transition from/to hover flight in off nominal flow fields and orientations



# The Outdoor Aerodynamic Research Facility (OARF)

- Model Check-Out and Thrust Calibrations

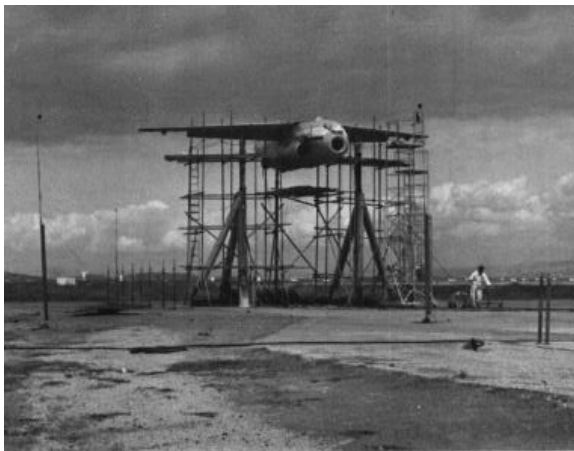

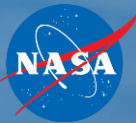

# The Outdoor Aerodynamic Research Facility (OARF)

- Hover Testing In- and Out-of-Ground-Effect



Smoke demonstrates just how large the hover flow field can be

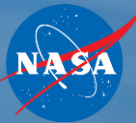

# The Outdoor Aerodynamic Research Facility (OARF)

- Jet Decay Rake Measuring Pressure Distribution of the Lift Fan Jet Exhaust



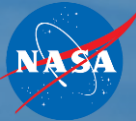

## Airspace / Vehicle Integrated Operations

- The aircraft, its trajectory, airspace, and environment all work together
  - The powered-lift aircraft has the ability to fly off-normal landing approaches. Can we optimize that?





# NM-STAT Noise Mitigation Smart Terminal Area Trajectory (Worst Acronym Ever!)

## The C-17 Noise Measurement Team



September 2005 – A demonstration of low cost testing techniques to measure the noise footprint of STOL approaches in the vicinity of an airport



## NM-STAT Noise Mitigation Smart Terminal Area Trajectory

- The Lakebed Acoustic Array Set Up and Three Types of Landing Approaches

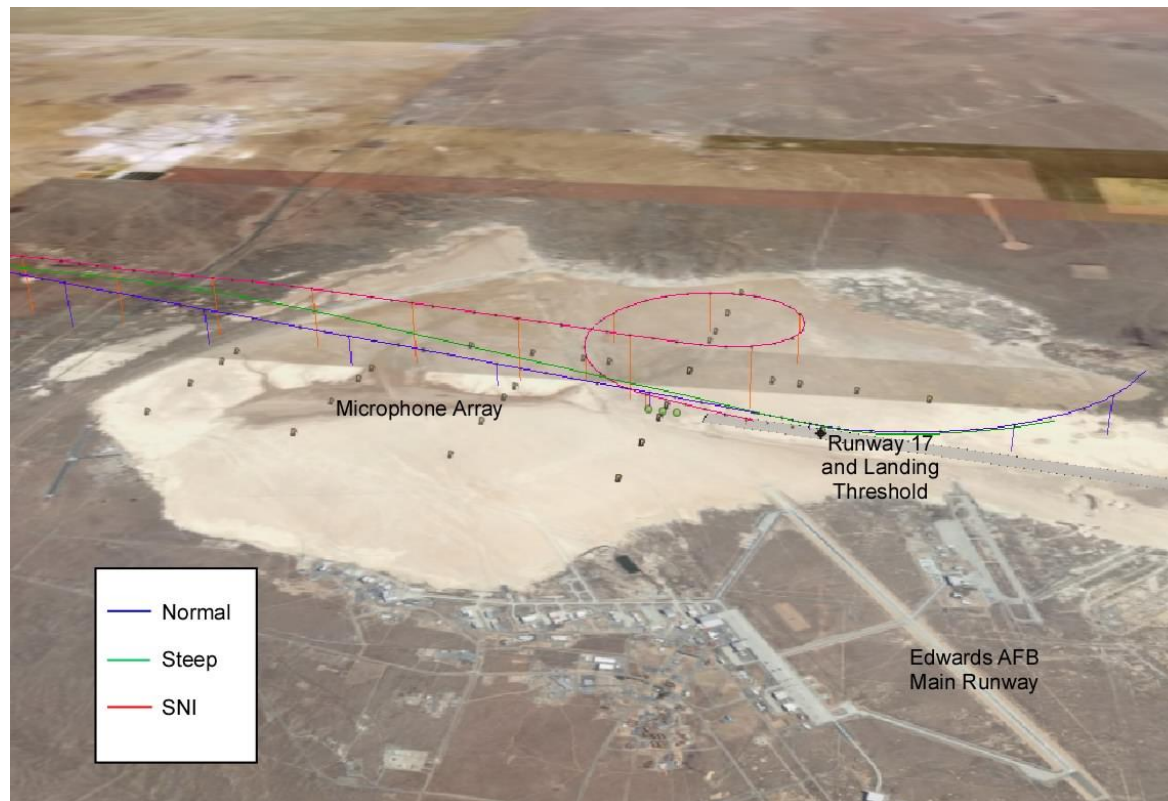

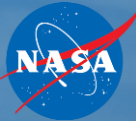

# NM-STAT Noise Mitigation Smart Terminal Area Trajectory

Typical Microphone / Computer Station with Cal Poly Student Operator

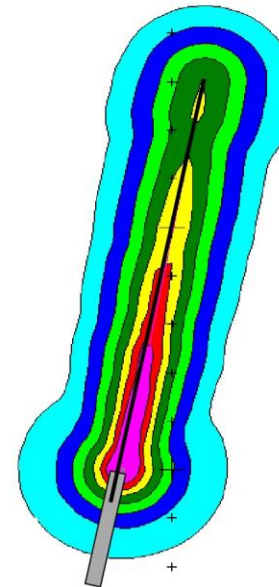

Standard 3-degree Approach

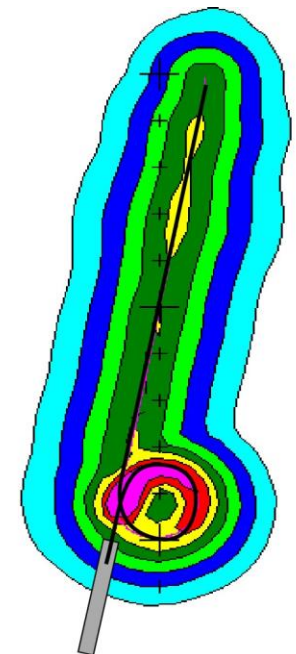

5-degree Spiral Simultaneous Non-Interfering Approach

Acoustic Footprint over adjacent areas

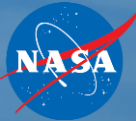

## Summary

- Ames has unique capabilities built on its long history and expertise in VTOL / STOL powered-lift
  - A History of Flying Unique VTOL and STOL Aircraft
  - Large-Scale Tests at the NFAC and OARF
  - Small-Scale Testing
  - CFD for complex VTOL flow fields
  - Acoustics of powered / augmented lift
  - Flight control systems research
  - Development of new displays and procedures to aid the pilot during unique take-off, transitions, and landing
  - Integration of aircraft and trajectory with the airspace and environment in the take-off and landing area

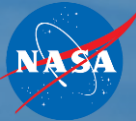

# Contributions to VTOL Powered-Lift State of the Art

- **Scale Effects**

- Analyzed how small-scale testing can be used as a cost-effective data source as long as a limited amount of full-scale testing supplements the database
  - One needs to match the jet decay characteristics for the scaling to be valid

- **Effect of Jet Decay**

- The jet structure effects the entrainment, mixing properties of the secondary flow
- Significant impact to the jet-noise
- Swirl introduced into the jet can bias the flow field

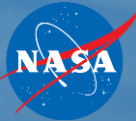

## Future Work That Will Be Needed for UAM

- Flow Field
  - Minimize negative flow effects, entrainment, re-circulation
  - Jet-induced moment predictions are poor
  - Understanding jet decay of lighter disc load fans
  - The optimization of electrical systems to facilitate VTOL aerodynamics
  - Understanding internal flows better
    - Auxiliary systems, especially cooling!
  - Measuring flow field in the presence of other structures
  - Foreign Object Damage (FOD)
- Noise!

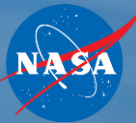

## Take-Away Points

- Ames has unique capabilities built on its long history and expertise in VTOL / STOL powered-lift
- VTOL / STOL powered-lift flight is not trivial, and you'll be amazed how uncooperative the flow field will be

