



Flutter Clearance for Captive Carry Flight Testing of the GO Launcher 1 Inert Test Article Mounted on C-20A Aircraft

CRASTE: June 27, 2018

Natalie Spivey¹, Shun-Fat Lung² & Robert Roglin³

(¹NASA-Armstrong Flight Research Center, Edwards AFB, CA;

²Jacobs Technology, Inc., Edwards AFB, CA;

³Generation Orbit Launch Services, Inc., Atlanta, GA)

- **Presentation will discuss details of NASA Armstrong's flutter clearance airworthiness approach required to clear the GO1 Inert Test Article (GO1-ITA) for captive carry flights**
- **Flutter Clearance Airworthiness Approach**
- **UAVSAR & ITA Comparison**
- **ITA Finite Element Model Development**
- **C-20 + ITA Ground Vibration Test**
- **ITA Moment of Inertia Test**
- **Finite Element Model Update**
- **ITA *mini*-Ground Vibration Test Checkout**
- **Flutter Analysis**
- **Flight Instrumentation**
- **Captive Carry Flutter Flight Testing**





Flutter Clearance Airworthiness Approach



- **Objective: Demonstrate the aeroelastic airworthiness for flight testing of the C-20 in a captive carry configuration with GO's ITA**
- **Requirements: Numerous project requirements, but the main level 1 requirement that drove all the other dynamics related requirements and the flutter clearance work was...**
 - C-20 aircraft with the GO1-ITA installed shall maintain a 20% margin on the flutter boundary
- **Four major tasks for dynamics were executed for airworthiness approach**
 - 1. Finite Element Model (FEM) Development**
 - Multiple ITA FEMs were created with increased complexity over the project life cycle
 - 2. Ground Tests**
 - C-20 + ITA Ground Vibration Test (GVT) – July 2017
 - ITA Moment of Inertia (MOI) Test – Oct. 2017
 - ITA *mini*-GVT Checkout – Nov. 14, 2017
 - 3. Flutter Analyses of C-20 + ITA**
 - Multiple C-20+ITA flutter analyses were performed over the project life cycle as complexity of the FEM increased and FEM was updated with GVT & later MOI data
 - 4. Captive Carry Flutter Flight Testing (envelope clearance)**
 - Supported flight planning, developed control room displays & supported flights

- **C-20 aircraft was structurally modified in 2006 with a fuselage centerline pylon and MAU-12 ejector rack interface to serve as a test bed for a variety of flight research experiments**
 - Unmanned Aerial Vehicle Synthetic Aperture Radar (UAVSAR) pod has flown on centerline pylon for over 10 years
- **Armstrong desired to use past UAVSAR pod analyses as much as possible for comparison by similarity for the ITA clearance \Rightarrow to save cost & schedule**
 - ITA was 2x longer than UAVSAR pod & had significantly higher I_{YY} (pitch inertia) & I_{ZZ} (yaw inertia)
 - UAVSAR was not a good representation of the ITA

UAVSAR & ITA Comparison

	UAVSAR	ITA (initial values)	% Difference
Length (in.)	129.6	262.8	-102.78%
Diameter (in.)	30	25.9	13.67%
Mass (lbm)	1200	1200	0.0%
CG_X (in)	346.95	346.26	0.2%
CG_Y (in)	0.53	0.00	100.0%
CG_Z (in)	10.26	9.14	10.9%
I_{XX} (lb-in ²)	115,558	199,152	-72.3%
I_{YY} (lb-in²)	905,584	5,503,688	-507.7%
I_{ZZ} (lb-in²)	899,509	5,486,416	-509.9%

Significant Differences

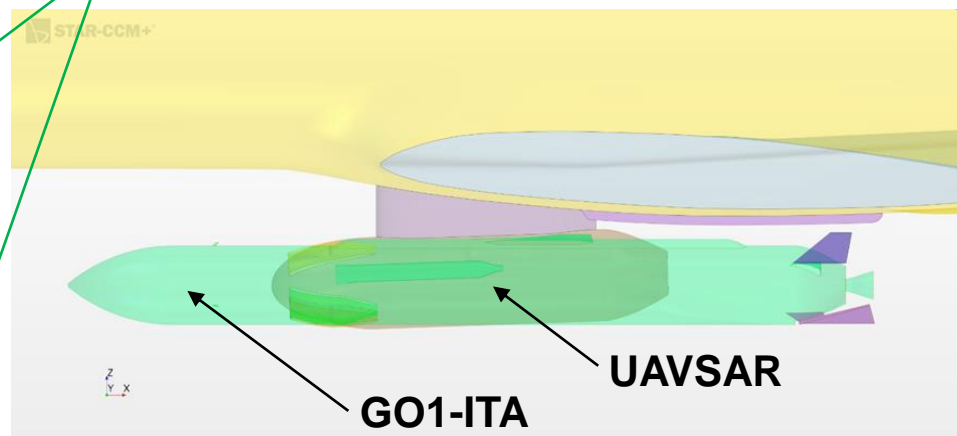

- **Multiple ITA FEMs were created with increasing complexity over the project life cycle**

- Used existing pylon & torque box FEM from UAVSAR FEM

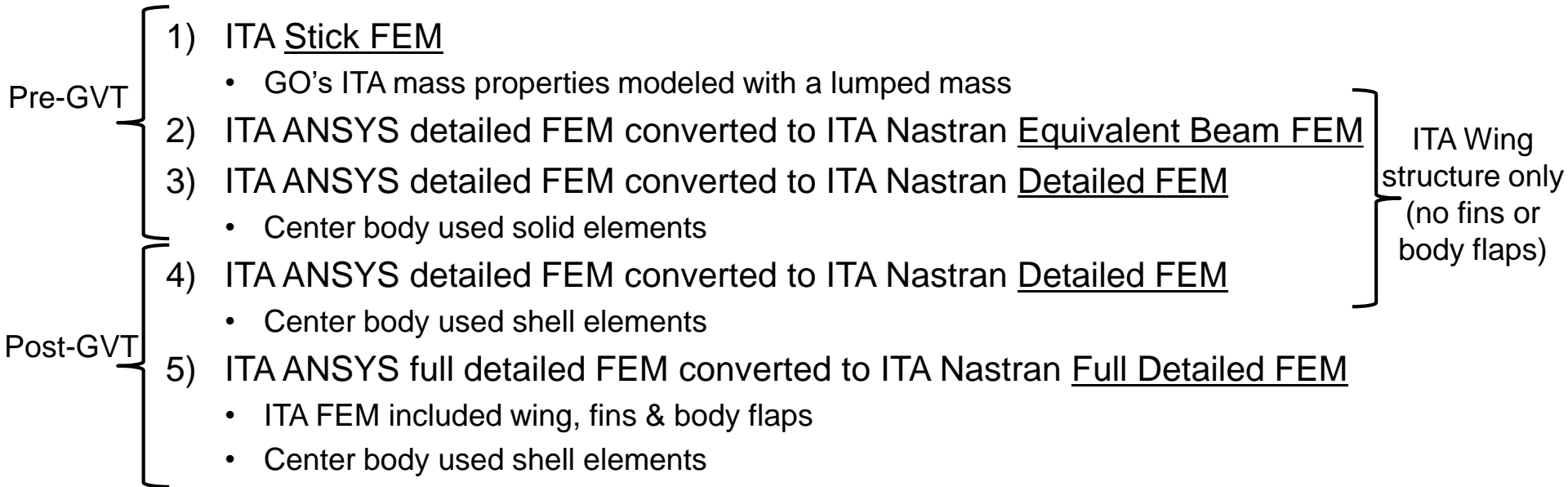

1) Stick FEM

2) Equivalent FEM

3) & 4) Detailed FEM

5) Full Detailed FEM

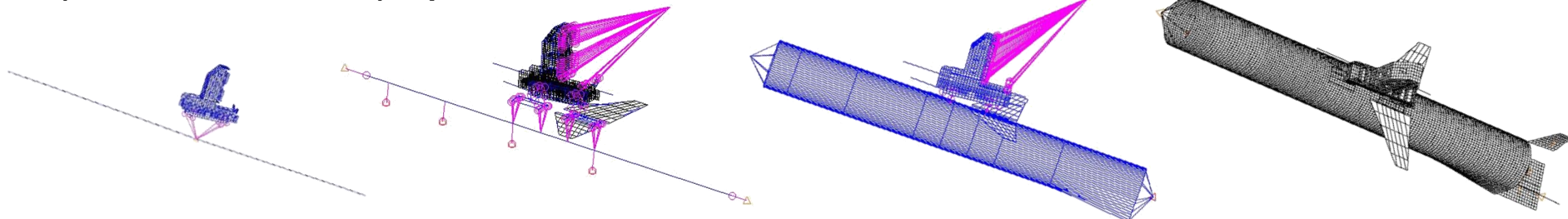

- **C-20 + ITA GVT** conducted for July 5-13, 2017 on TN502 at Armstrong's 703 facility
- **GVT** required to update & validate the ITA FEM
- **Objectives:**
 - Primary Objectives
 - Measure primary frequencies & mode shapes of the ITA rigid body modes (pitch, roll & yaw)
 - Measure first ITA flexible bending frequencies & mode shapes
 - Secondary Objectives
 - Measure ITA frequencies & mode shapes of the control surfaces
 - Measure lower (up to 20 Hz) C-20 frequencies & mode shapes with ITA installed
 - Measure C-20 main gear door frequencies with the doors extended and the ITA installed
- **Setup:**
 - C-20 with empty fuel configuration & on *soft* tires
 - GO's ITA installed in *near* final flight configuration
 - Body flaps & fins were not in the final flight configuration

C-20 + ITA GVT (July 2017)



- **Total of 135 external accelerometer locations measuring \approx 236 DOFs**
 - C-20: fuselage, wings, winglet, engines, T-tail, landing gear & gear doors
 - ITA: center body, wings, fins & body flap
 - Centerline pylon
- **Excitation used electromagnetic shaker(s) & impact hammer**
- **Excitation configurations:**
 - Config. A: 1 Shaker, ITA aft fuselage
 - Config. B: Impact hammer, ITA aft fuselage
 - Config. C: Impact hammer, C-20 Main Landing Gear Doors
 - Config. D: 3 Shakers, C-20 wingtips & ITA aft fuselage

GVT Test Display Model

Green: C-20 airframe
 Blue: Landing gear
 Pink: ITA
 Red: Pylon

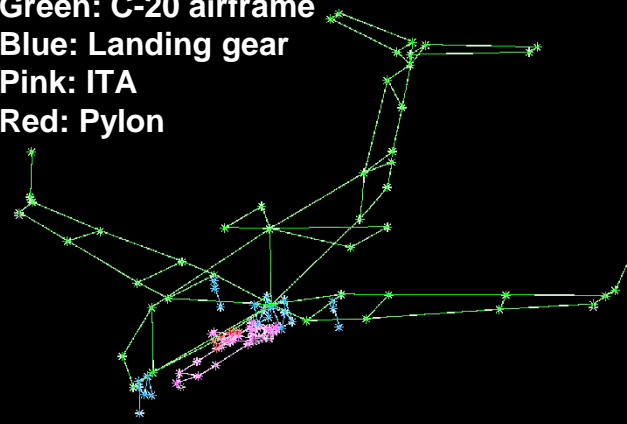

Excitation Locations

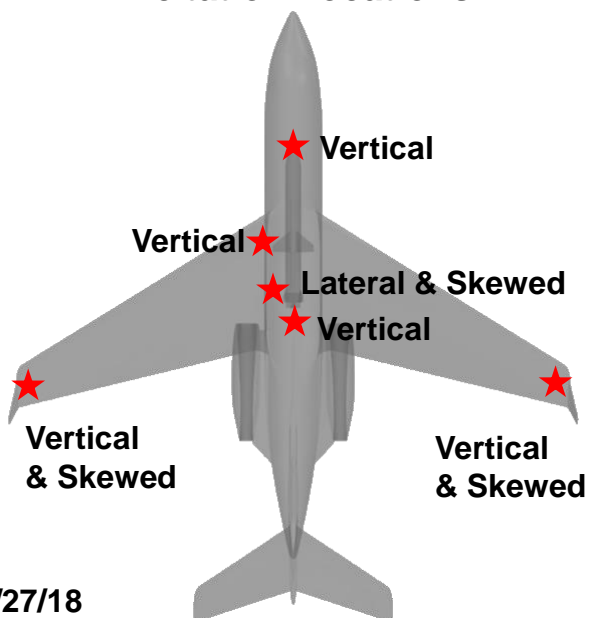

Config. A – ITA Shaker



CRASTE 2018

Config. B – ITA Impact Hammer



- Total of 35 GVT test runs were acquired
- All primary & secondary test objectives were satisfied
- ITA GVT rigid body frequencies were very close together (within ≈ 1 Hz) & much lower than UAVSAR and yaw & pitch modes switched order
 - ITA mode order & frequency \Rightarrow Roll, Yaw, Pitch
 - Two ITA roll modes measured: one clean ITA roll mode & one ITA roll mode coupled with C-20
 - UAVSAR mode order & frequency \Rightarrow Roll, Pitch, Yaw and much higher than ITA (not a good ITA representative)

C-20 + ITA GVT Modes Measured

Mode	Description
1	ITA roll
2	ITA yaw
3	ITA pitch
4	ITA right body flap coupled with slight C-20 mode
5	ITA left body flap coupled with slight C-20 mode
6	ITA wing antisymm
7	ITA fin antisymm In-Phase w/wing antisymm
8	ITA fin antisymm Out-Of-Phase w/wing antisymm
9	ITA wing symm
10	ITA vertical bending
11	ITA fin symm
12	ITA fin fwd/aft symm

ITA GVT: Rigid Body Modes

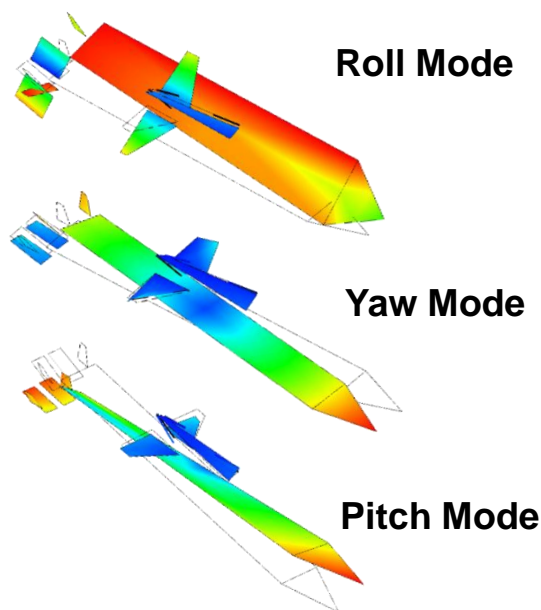

- ITA Moment of Inertia (MOI) testing conducted at GO in Oct. 2017

- GO developed a MOI test stand based on inverted pendulum method utilizing a spring assembly
- Measured roll, yaw & pitch inertia (I_{XX} , I_{YY} , I_{ZZ}) & I_{XZ}
 - Suspected error in roll inertia, I_{XX} which also affected I_{XZ} so project used I_{XX} & I_{XZ} results from updated CAD

ITA MOI Testing



Final GO1-ITA Mass Properties at ITA CG

	Updated CAD Anchored to MOI test data	Measured from MOI test	Sim, Target Values	FEM w/ MOI results	Final Properties	Final Properties	Final Properties for Load Analysis
Weight (lbm)	1,206.7	1,206.8	1,200.0	1203.9	1,206.8	1,206.8	1,206.8
CG_X (in)	99.61	99.61	99.80	99.61	99.61	99.61	99.61
CG_Y (in)	-0.02	-0.21	0.00	-0.208	-0.21	-0.21	-0.21
CG_Z (in)	0.34	0.35	1.36	0.351	0.35	0.35	0.35

Project's Final mass properties from MOI test & CAD updated to match MOI test results

	Updated CAD Anchored to MOI test data (lbm-in ²)	Measured from MOI test (lbm-in ²)	Sim, Target Values (lbm-in ²)	FEM w/ MOI results (lbm-in ²)	Final Properties (lbm-in ²)	Final Properties (lbm-ft ²)	Final Properties for Load Analysis (slug-ft ²)
I _{xx}	204,318	TBD	199,152	179,900	204,318	1419	44
I _{yy}	5,738,382	5,754,859	5,503,680	5,770,000	5,754,859	39964	1242
I _{zz}	5,718,991	5,747,653	5,486,400	5,740,000	5,747,653	39914	1241
I _{xy}	8,224	0	-259	-7,720	8,224	57	2
I _{xz}	62,080	TBD	17,136	71,100	62,080	431	13
I _{yz}	174	0	-14	-2,150	174	1	0

ITA FEM Update Process

- **After the GVT, the FEM model updating process began to match the GVT data and was done three different times with increased FEM complexity & FEM design variables**
 - 1st time: ITA Detailed Post-GVT FEM manually tuned the ITA's center body composite Young's Modulus for matching ITA rigid body modes only
 - 2nd time: ITA Detailed Post-GVT FEM manually tuned the ITA's center body composite Young's Modulus & connection stiffness for matching ITA rigid body modes only
 - 3rd time: ITA Full Detailed Post-GVT FEM (included fins & body flap) manually tuned to adjust the ITA's wings, fins and body flaps stiffness & mass properties
- **After MOI testing, the FEM was updated and manually tuned a final time to better match the ITA mass properties**

ITA Detailed FEM

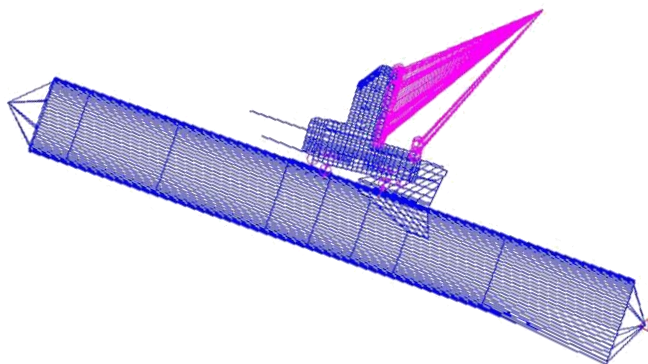

ITA Full Detailed FEM

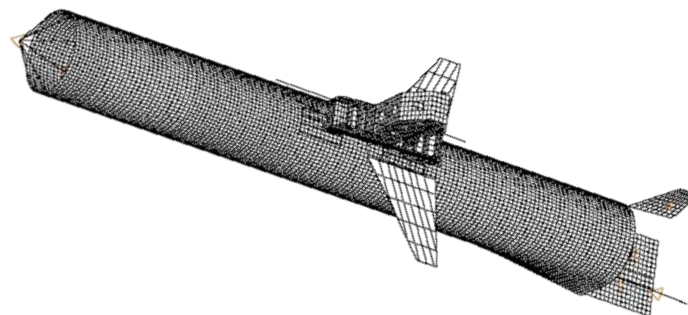

- **C-20 + ITA *mini-GVT* Checkout** conducted for Nov. 14, 2017 on TN502 at 4801
 - Required due to many changes to the ITA since the July GVT
 - Closed several RFAs & put to rest the MOI testing issue with roll inertia, I_{xx}
- **Objectives:** To measure ITA rigid body (roll, yaw & pitch) & ITA fins and body flaps frequencies & mode shapes
- **Setup:**
 - C-20 with empty fuel configuration & tires fully pressurized
 - ITA installed in final flight configuration
 - 24 triaxial accels installed on ITA, centerline pylon and pylon to aircraft connection
- **Results:** All ITA rigid body & control surface frequencies increased

C-20 + ITA *mini-GVT* Checkout (Nov. 14, 2017)



Impact hammer
used for excitation



Comparison: GVTs vs. *Updated FEMs*

- *Mini-GVT* showed all ITA rigid body & control surface frequencies increased, so the final flutter analysis using the final updated FEM was deemed conservative due to the lower analytical frequencies

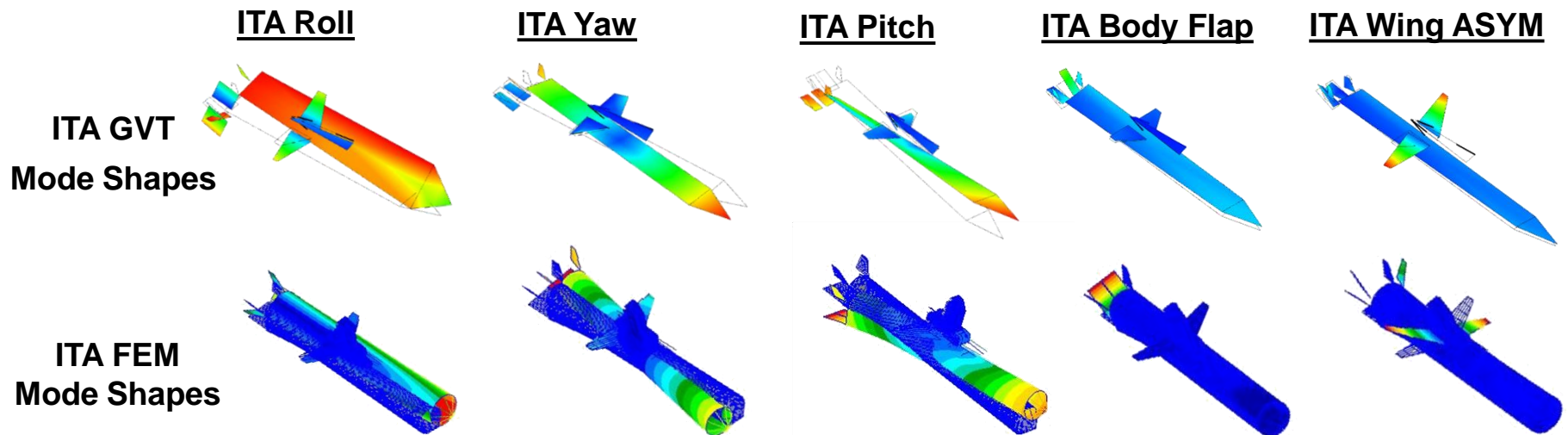

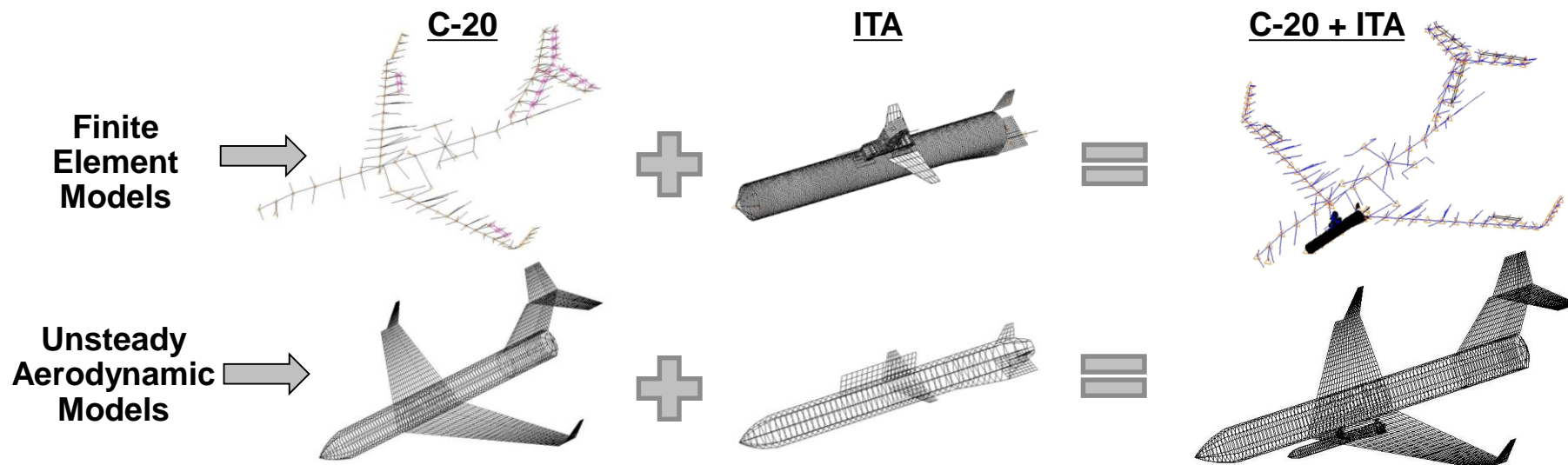

- ITA only flutter analysis was conducted & NO ITA flutter or divergence was found
- Match point flutter analysis done at 0.87M & 0.95M in ZAERO
 - Analysis done with both aircraft heavy & light fuel
- Flutter analysis assumed 0% damping - more conservative
- 20% flutter margin requirement was met with ITA installed
 - Flutter margin & flutter mechanism details are Gulfstream Aerospace Corporation proprietary
 - Final ITA FEM update did not change the flutter results after GVT
- ITA slightly changed the typical C-20 flutter mechanism, but ITA roll modal participation factor was low
 - Past NASA experiments have not changed the C-20 flutter mechanism
 - External stores/pods normally have higher frequencies like UAVSAR frequencies

Flight Envelopes with 20% Flutter Margin

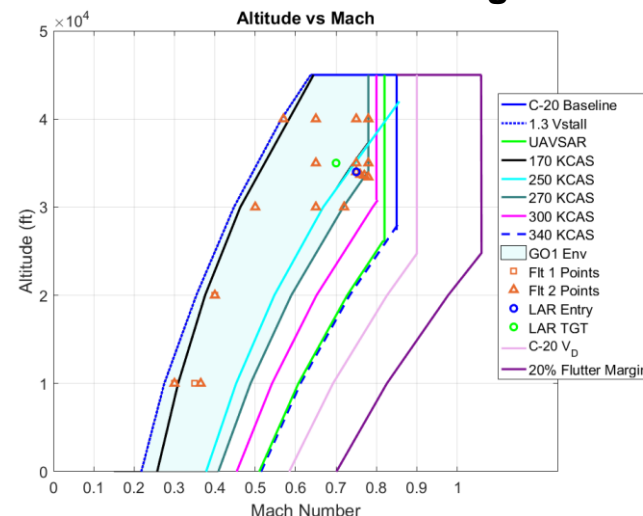

- **C-20 & ITA accelerometers were telemetered from ITA to Armstrong's control room**
 - ITA's instrumentation system provided signal conditioning for both C-20 & ITA accels
- **After Combined System Test (CST) & prior to 1st flight some of the Safety of Test (SoT) ITA accelerometers were changed**
 - ITA accels showed little amplitude response during CST due to accel type & resolution (10 mV/g, $\pm 500g$'s)
 - Replaced ITA nose accels with 2 higher resolution triaxial accels, PCB T356A16 (100 mV/g, $\pm 50 g$'s)
- **C-20 & ITA accels were either Safety of Test (SoT) Go/No-Go or Technically Desired (TD) parameters during envelope clearance flights. All SoT accels had backups**
 - C-20: 9 uniaxial accels, 6 SoT & 3 TD parameters
 - ITA: 8 triaxial accels & 12 uniaxial accels, 2 SoT & 20 TD parameters
 - Pylon: No accels

C-20 Accels

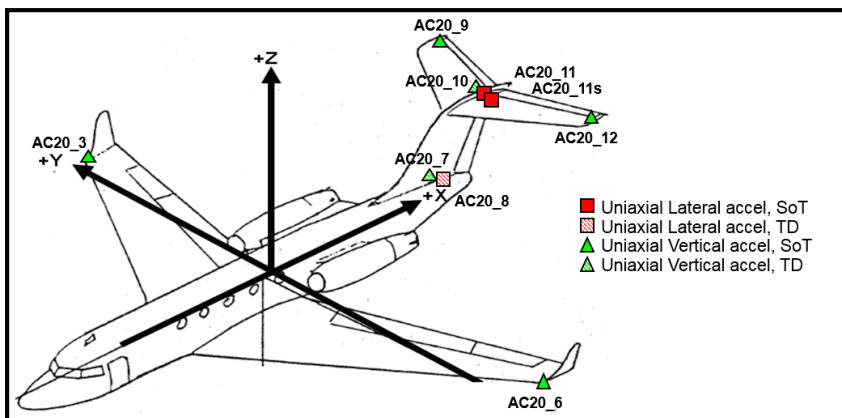

ITA Accels

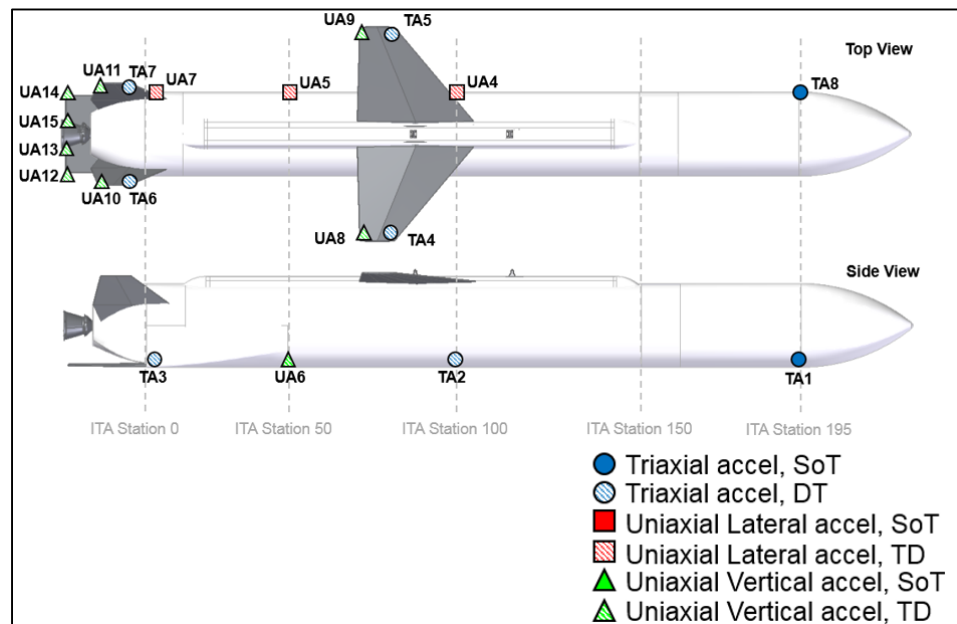



Dynamics Flight Test Approach & Control Room Operations



- **Build-up approach was used for envelope expansion**
 - Dynamics Maneuvers: Steady-state and Raps (not done above 250 KCAS)
- **Flight accels used to assess C-20 & ITA aeroelastic characteristics**
- **Dynamics control room staffing \Rightarrow Required minimum of two, desired four**
- **Control room operations:**
 - Conducted steady-state maneuver, dynamics evaluated data quality then gave clearance to next test point
 - Dynamics 2 & 3: *Conducted IADS time-domain analysis to estimated frequencies & damping (note: analysis failed/could not be computed due to the TM/packet dropouts)*
 - Conducted raps (pitch, roll & yaw), dynamics evaluated data quality then gave clearance to next test point
 - Dynamics 2 & 3: *Conducted IADS frequency-domain analysis to estimate frequencies & damping*
- **After 1st flight control room operations slightly changed**

Initial Plan

1st Flight: Steady-state & Raps

- 40k ft, 0.65M (116 psf)
- 40k ft, 0.75M (155 psf)
- 40k ft, 0.82M (185 psf)

2nd Flight: Steady-state only

- 30k ft, 0.66M (192 psf)
- 30k ft, 0.72M (228 psf)

1st Flight, Clears to 250 KCAS

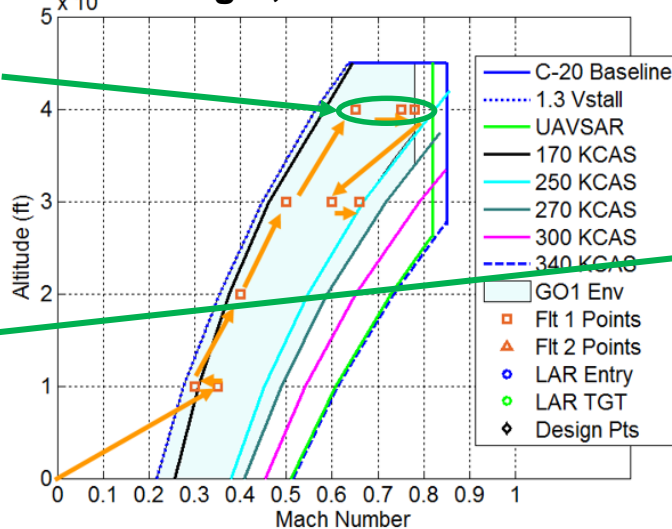

2nd Flight, Clears to 270 KCAS

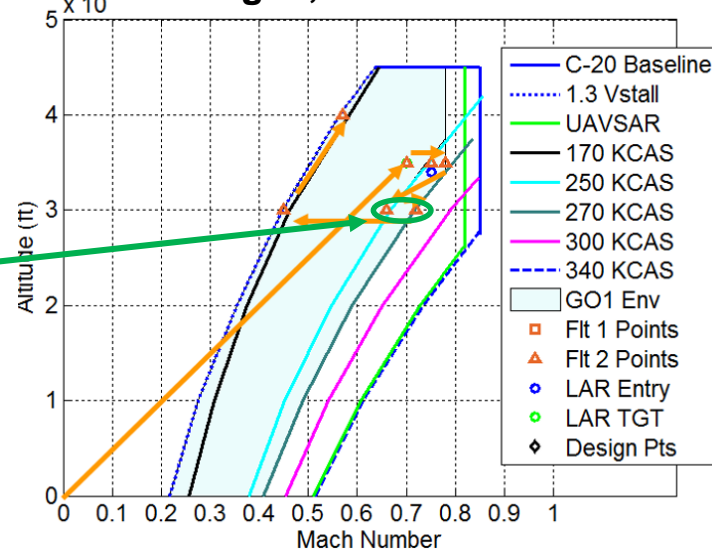

Dynamics Control Room Responsibilities

- Developed control room displays using IADS to monitor real-time C-20 + ITA aeroelastic responses for envelope expansion flights
- Dynamics had 4 displays available in the control room

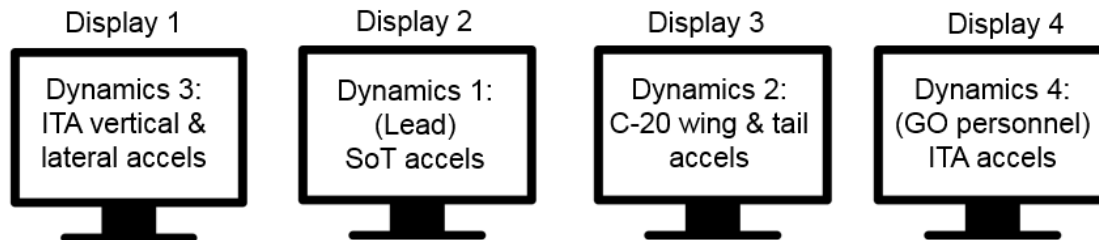

Dynamics Control Room Team



Dynamics 1 (Dynamics Lead)

Responsibilities:

- Monitor all C-20 & ITA Safety of Test accels
- Monitor for diverging oscillations
- Clears test points
- Logs dynamics event markers

Dynamics 2

Responsibilities:

- C-20 wing & tail accels
- Switches between tabs to conduct time & frequency domain analyses to estimate frequencies & damping then log values

Dynamics 3

Responsibilities:

- ITA vertical & lateral accels
- Switches between tabs to conduct time & frequency domain analyses to estimate frequencies & damping then log values

Dynamics 4

Responsibilities:

- ITA accels



Dynamics Control Room – Display Example



- Dynamics 1 (Lead): Monitored all Safety of Test accels using 1st tab “Overall & SoT”
 - Maneuver shown: 30° Flight Angle Launch Abort Release maneuver

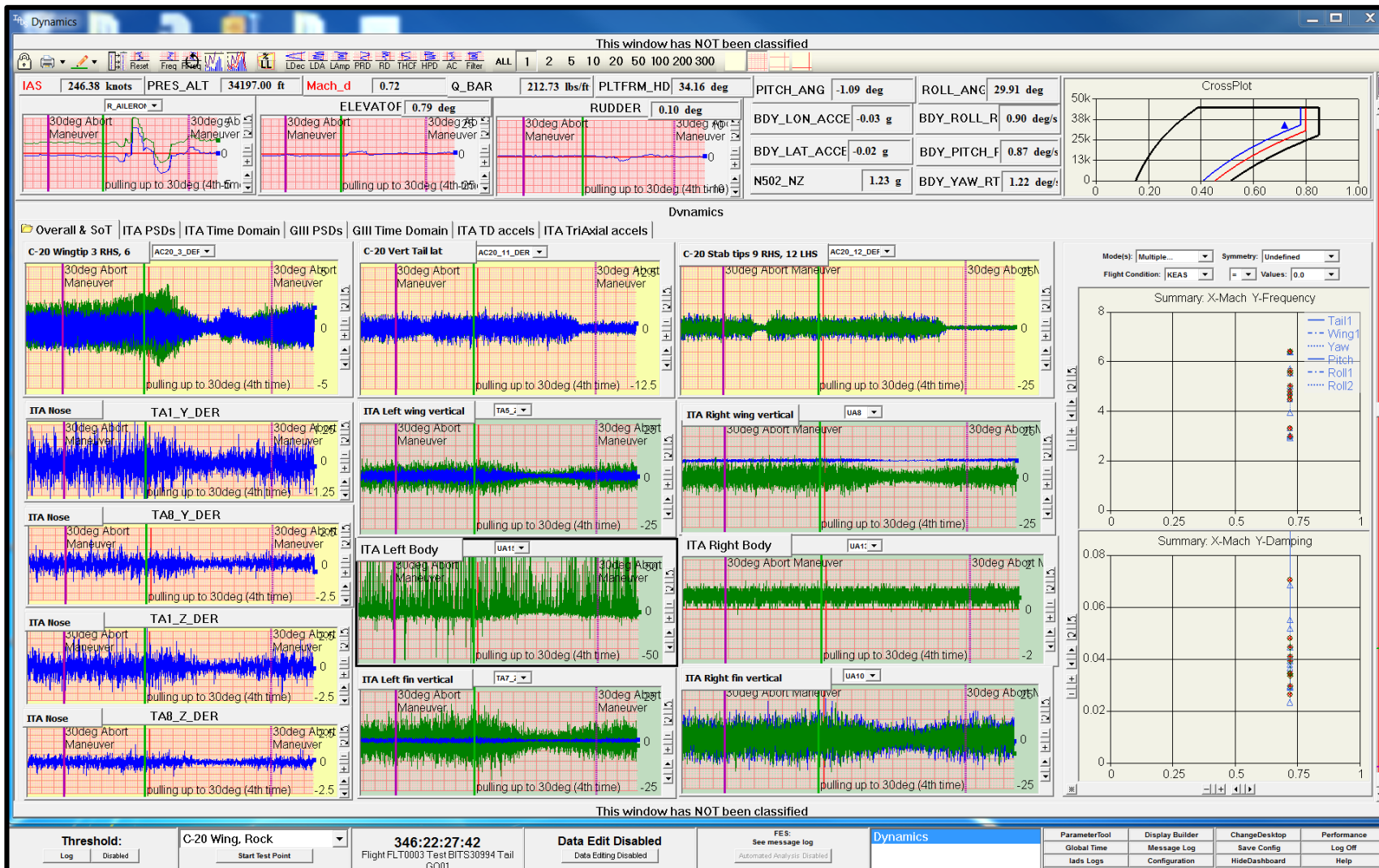



C-20 + ITA Captive Carry Flight Testing



- **Dynamics Observations after 1st flight**

- Flt #1 evaluated modal characteristics during steady-state maneuvers only (highest $Q_{bar} \approx 114$ psf), no raps conducted before RTB was called
- Steady-state maneuvers provided enough broadband excitation to excite both the aircraft & ITA modes of interest (very nice, unexpected)
 - Dynamics evaluated data quality then gave clearance to next test point, then conducted IADS frequency-domain analysis to estimate frequencies & damping
 - Frequencies & Damping followed expected trends
- IADS Time-domain Random Decrement (RD) + Time History Curve Fit (THCF) analysis failed/could not be computed due to the TM/packet dropouts

- **Dynamics Go Forward Plan for 2nd flight**

- Dynamics-continued to evaluate frequencies & damping with PSDs from steady-state maneuvers as higher dynamic pressures were cleared
 - Frequencies & damping were evaluated
 - In flight \Rightarrow Frequencies & damping followed expected trends, so dynamics eliminated rap maneuvers and ITA captive carry flight envelope was cleared

- **Dynamics 3rd flight**

- Monitored accels during the ITA launch abort release maneuver starting with a 15° pitch attitude and the desired 30° pitch attitude

- ITA GVT rigid body frequencies were close together (within ≈ 1 Hz) & much lower than UAVSAR
- *Mini-GVT* showed an increase in the ITA rigid body & control surface frequencies for the final ITA flight configuration which was good for flutter
- Final flutter analysis using FEM updated with MOI data showed adequate flutter margin for flight testing
- A build-up approach was used for envelope expansion flights & dynamics monitored C-20 & ITA accelerometers
 - Dynamics maneuvers ended up being only steady-state test points (no raps)
- ITA captive carry flight envelope was cleared with no aeroelastic issues

