

Development And Qualification Of The Primary Structure Of The Orion European Service Module

Paolo PALMIERI⁽¹⁾, Luigi RUTIGLIANO⁽¹⁾, Secondo OTTAVIANO⁽¹⁾,
David MIOCHE⁽²⁾, Gandolfo DI VITA⁽³⁾, Louis J. GHOSN⁽⁴⁾

⁽¹⁾Thales Alenia Space Italia, Italy, paolo.palmieri@thalesaleniaspace.com, luigi.rutigliano@thalesaleniaspace.com,
secondo.ottaviano@thalesaleniaspace.com

⁽²⁾ArianeGroup, France, david.mioche@ariane.group

⁽³⁾European Space Agency, ESTEC, The Netherlands, gandolfo.divita@esa.int

⁽⁴⁾NASA, GRC, USA, louis.j.ghosn@nasa.gov

ABSTRACT

This paper presents an overview of the development and qualification test campaign for the primary structure of the European Service Module of ORION, the NASA spacecraft which will serve the future human exploration missions to the Moon, Mars and beyond.

Under an agreement between NASA and ESA, the ORION will be powered by a European Service Module (ESM), providing also water and oxygen for astronauts' life sustainability.

The development and qualification of the European Service Module (ESM) is under ESA responsibility with Airbus Defence and Space as the prime contractor.

Thales Alenia Space Italia is responsible for design development, manufacturing, assembly and qualification of the Structure subsystem.

The European Service Module, installed onto the launch adapter, shall support the crew module with its adapter and a launch abort system. It shall sustain:

- A combination of global and local launch loads during lift off and ascent phases
- On orbit loads induced by engine firing for orbital transfers and attitude control.

The ESM structure is based on a core made of Composite Fiber Reinforced Polymer (CFRP) sandwich panels complemented by aluminium alloy platforms, longerons and secondary structures.

A development campaign has been implemented in order to define and validate composite parts' strength allowable values for design: coupon tests at material level, test at component level up to breadboards tests performed on main structural components (composite to metallic joints, and at panels' discontinuities). An incremental approach as defined in [1] has been followed.

A qualification static test campaign at primary structure assembly level has been implemented in order to validate the design against static stiffness and ultimate strength as well as to correlate the structural Finite Element Model (FEM) used for sizing and confirm the margins of safety. The tests have been performed successfully by Thales Alenia Space Italia (TAS-I) on two flight representative structural models (STA1, STA2), in Turin facilities (Italy) between August 2015 and March 2017, with engineering support of technical representatives from Airbus, ESA, NASA and LMCO.

The main development and qualification test activities and associated results are presented and discussed in the paper

1. INTRODUCTION

The Orion spacecraft is meant to bring astronauts back to the Moon and to destinations beyond (e.g. Mars, asteroids). Orion is currently being developed and built for NASA by LMCO and it will be launched on a newly developed heavy launch rocket (Space Launch System). Under an agreement between NASA and ESA, the Orion will be powered by a European Service Module (ESM).

The European Service Module (ESM) provides power, propulsion, thermal control and commodities (water, oxygen, nitrogen) for astronauts' life sustainability in space environment during the mission, from launch through separation prior to re-entry. The ESM can also transport small unpressurized cargo and scientific payloads

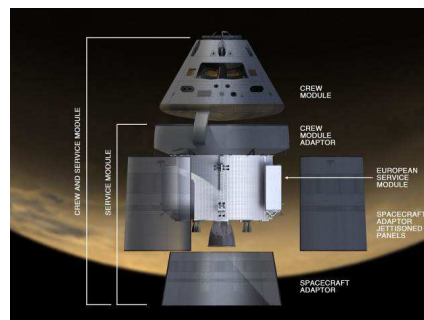

Figure 1. Orion with ESM

The ESM prime contractor and system design responsible is Airbus Defence and Space, while Thales Alenia Space Italia is responsible for the design and integration of the ESM Structure and Micro-Meteoroids and Orbital Debris (MMOD) protection, the Thermal

Control System and the Consumable (Water, Oxygen and Nitrogen) Storage System.

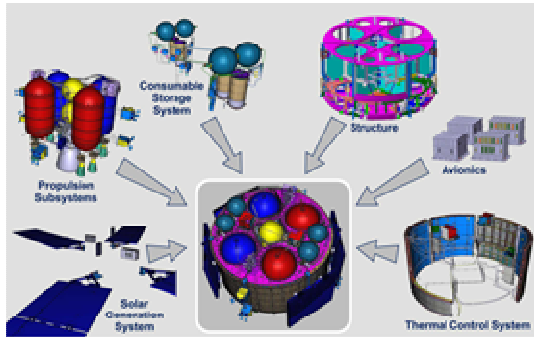

Figure 2. The ESM and its subsystems

2. ESM MECHANICAL ARCHITECTURE

The ESM mechanical architecture is mainly composed of Primary Structure, Secondary Structure and MMOD protections.

The **Primary Structure** main elements are:

- **LONGERONS**
- **CENTRAL CORE:** composed of three main parts
 - Tanks Bulkhead
 - Webs Assembly
 - Lower Platform Assembly
- **OMS-E SUPPORT**

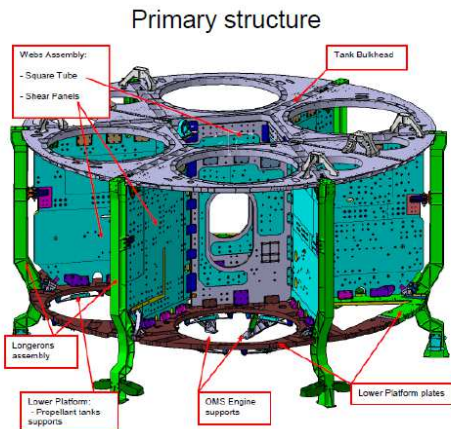

Figure 3. ESM primary structure

The **Secondary Structures** of the ESM are composed by all the structures needed to accommodate and support Auxiliary Thrusters, attitude control Thruster Pods, Solar Arrays, MDPS (Micrometeoroids and Debris Protection System) bumpers, Water Tanks, Gas tanks and Radiators

The **Micrometeoroids and Debris Protection System (MDPS)** of the ESM is meant to protect the ESM equipment from impacts induced by high energy particles which may be encountered by the ESM along the mission.

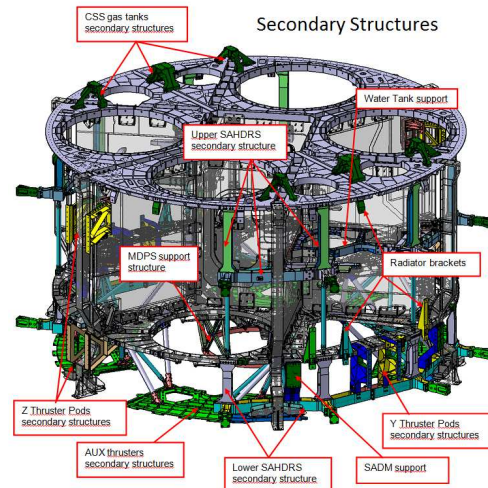

Figure 4. ESM secondary structures

3. STRUCTURE DEVELOPMENT

ESM primary structure Webs Assembly is based on composite parts which required a specific development test campaign; following rules specified in [1], the Carbon-Fibre-Reinforced-Polymer (CFRP) based composite structures have been subjected to a development incremental (“building block”) approach. A test plan has been defined and implemented in order to validate the composite mechanical behaviour both in laminates (unidirectional and multidirectional) and in sandwich panels with aluminium honeycomb core. Composite performance has been also verified after wet conditioning and in presence of defects (such as: debonding, delamination, and after impacts).

The plan included also the verification of adhesive joints mechanical performances.

Finally, some components in flight configurations (breadboards) have been tested in order to check the most critical parts and joints, identify and anticipate any possible issue before going into a detailed final design and to validate the suitability of the mathematical model for accurate composite parts behavior.

The CFRP material selected for structural design was already qualified in TAS-I but a material characterization test campaign has been performed to complement the available data and cover all the ORION-ESM project needs (e.g. A-basis allowable strength values, knock down factors for defects) and configurations included in ESM structure design (e.g. potted inserts allowable strength). The following tests have been performed by TAS-I:

- **material characterization at lamina level:**
 - 0° Tensile Strength (dry and wet conditions)
 - 90° Tensile Strength (dry and wet)
 - 0° Compressive Strength (dry and wet)
 - 90° Compressive Strength (dry and wet)
 - In-plane Shear Strength
 - Inter Lamina Shear Strength (dry and wet)

- 0° Tensile Modulus
 - 90° Tensile Modulus
 - 0° Compressive Modulus
 - 90° Compressive Modulus
 - In-plane Shear Modulus
 - Bearing strength
 - Cured Ply Thickness
 - CTE
 - Fiber/Resin/Voids content
- material characterization at sandwich panel level:
 - Long Beam Flexure
 - Edgewise Compression
 - Edgewise Compression with delamination, debonding and impact (for damage tolerance)
 - Flatwise Tension
 - characterization of potted inserts
 - characterization of bonded joints (hot and cold bonding adhesives in dry and wet conditions)
 - lap shear
 - flatwise

Material characterization test results demonstrated good strength capability of the selected CFRP material, in line with or better than estimated allowables utilized in the preliminary design.

Properties of the material obtained during the tests, with relevant statistical basis, have been considered in the detailed design and FEM analyses.

Pictures of the coupon test specimens are shown in the figures 5 and 6.

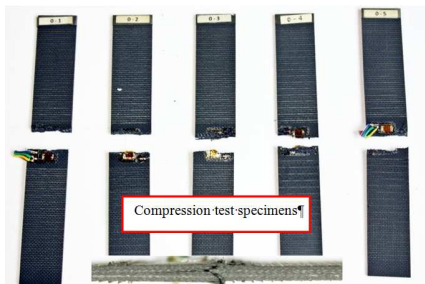

Figure 5. Composite test specimens (example of lamina characterization test)

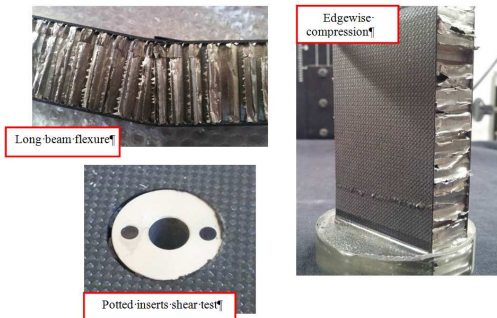

Figure 6. Composite test specimens (examples of sandwich characterization tests)

Following material characterization, a breadboard test campaign has been performed to support the design activities of major interfaces (composite to metallic joints) and anticipate potential issues due to uncertainties in the FEM analyses

A breadboard test named “**BB1 reduced**” has been performed and repeated twice; a first attempt with a preliminary design has been done, then the available margins have allowed optimizing the joint and saving mass. The expected behavior has been confirmed by a repetition of the test.

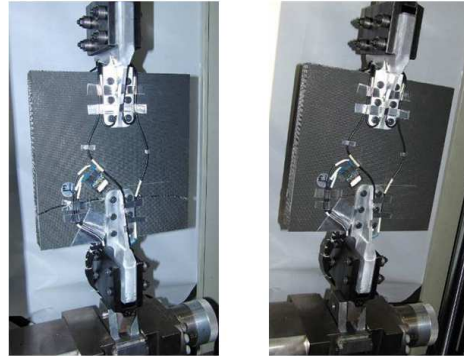

Figure 7. BB1 “reduced”

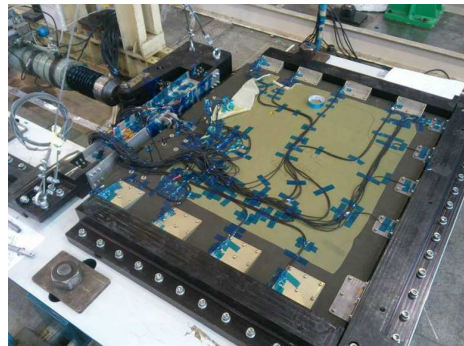

Figure 8. BB1 “complete”

Other breadboards, named “**BB1 complete**” (entire panel with relevant interfaces), **BB2** (long beam flexure with laminated skin thickness discontinuity) and **BB3** (joined panels section with tank interface and portion of large cutout), have been performed with the objective of evaluating the critical failure modes, increasing the confidence on FE modeling and relevant capability to predict the structural behavior of the composite parts, mitigating risks for the need of a later re-design.



Figure 9. BB2

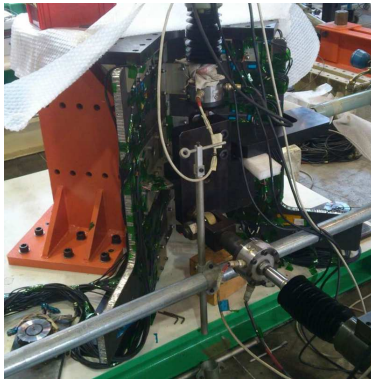

Figure 10. BB3

The performed tests have met all relevant success criteria and they showed good design margins.

One additional breadboard, named BB4, has been manufactured and tested in order to verify the design of a main primary structure joint between the Longerons and Central Core. These development activities were deemed necessary to anticipate possible unforeseen behavior under cyclic loading and dynamic vibration.

Two test articles have been manufactured and subjected to the following tests:

- Fatigue test of single joint with the following test objectives:
 - characterize the life capability of the joint under flight representative load spectrum
 - Evaluate the friction coefficient at different load levels (to check for possible non linearity): at BoL, in between and at EoL
- Dynamic testing of a panel with n.4 joints with the following test objectives:
 - Evaluate potential non linearity as a function of the radial load (bearing preload)
 - Evaluate potential non linearity due to geometrical tolerances
 - Anticipate possible unexpected dynamic behavior during ESM system level dynamic testing and support relevant explanation.

A description of the manufactured test article is shown in figures 11 thru 13.

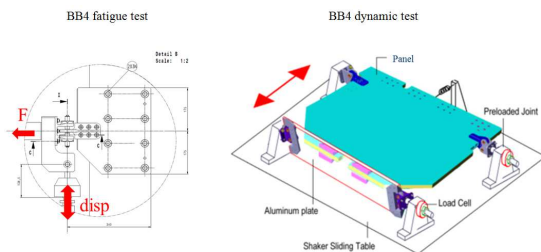

Figure 11. BB4 test articles

The performed tests have met all relevant success criteria and demonstrated design robustness against fatigue and no unexpected dynamic behavior:



Figure 12. BB4 Fatigue test

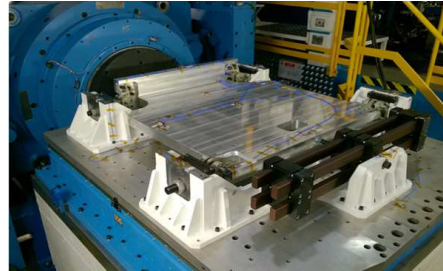

Figure 13. BB4 Dynamic test

4. STRUCTURE VERIFICATION

The overall ESM mechanical system verification is under Airbus responsibility. TAS-I is responsible for ESM structure design and verification. Static stiffness and structural strength has been verified by the mean of two main test articles:

- 1) STA-1 (First Structural Test Article). This first test article, a representative of the ESM preliminary design (post-PDR), has been used to verify the Static Stiffness requirements (global and local) and provide early validation of the mathematical models for the stress/strength analysis.

Note: STA-1 article has been subsequently outfitted with equipment dummies and used by Airbus to become part of an integrated ORION STA subjected to a set of vibration and acoustic tests for dynamic verification. Moreover, the STA1 is being used by LMCO inside a complete test article for structural qualification of other elements of ORION stack

- 2) STA-2 (Second Structural Test Article). This structural model, a fully representative of the flight hardware, has been the basis for the structure subsystem qualification. STA-2 test article has been subjected to a static test up to limit (max. flight load) and 1.4xlimit (i.e. ultimate) loads, in order to verify all structural requirements and complete/confirm the validation of the Finite Element Models used for stress analysis and margin calculations.

Note: qualification was focused on main failure modes (lowest margins of safety of each structural component) and using ESM structure symmetry and parts similarity, when possible, to limit the amount of the loading test cases.

The test campaigns were conducted by TAS-I with engineering support provided by NASA/Lockheed Martin for aspects relevant to the CMA simulator (customer furnished equipment). NASA, Lockheed Martin, Airbus and ESA engineering representatives were also present to support test results evaluation and participated in discussions and decisions about anomalies detected during the test campaign.

4.1. STA-1 Test Campaign Summary

A test campaign has been performed on the first structural qualification model (S-STA1) with the following objectives:

- Support the verification of Structure Subsystem stiffness requirements:
 - ESM global stiffness
 - propellant tanks mounting I/F stiffness
 - Main Engine mounting I/F stiffness
- Check the global load path and stress distribution by applying significant loads allowing the preliminary validation of the FEM.
- Check the structural integrity and increase the confidence that the composite panels and main interfaces were produced / assembled in conformance with the design.

The S-STA1 test article was made of a complete primary structure of the ESM, connected to specifically designed secondary hardware simulators with the purpose of duplicating the interface stiffness and allow for a better representativeness of the test setup as compared to the flight conditions:

- Spacecraft Adapter (SA) simulator, placed below the ESM; procured by TAS-I based on physical properties of the flight item as provided by NASA/Lockheed Martin
- Crew Module Adapter (CMA), placed on the top of the ESM; designed and manufactured by Lockheed Martin based on physical data of the flight item

Note: thanks to the selected test article configuration, it was possible to define test load cases with the highest possible representativeness to flight conditions and to verify the majority of the requirements directly from the measured test data. For the remaining verification cases, the FE model was correlated against test measurements and the requirements were closed by analysis.

Pictures of the S-STA1 test article are shown in figure 14 and 15.

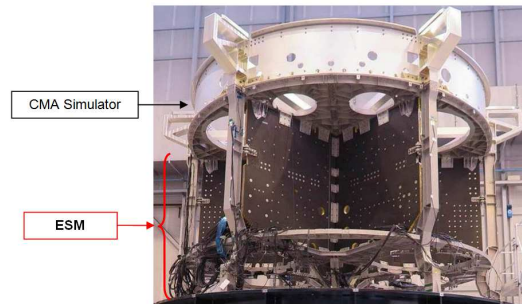

Figure 14. S-STA1 test article

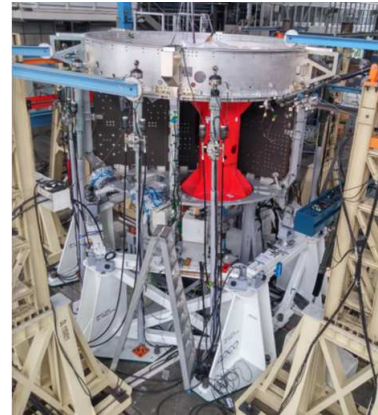

Figure 15. S-STA1 test article (including test support equipment)

The STA1 mechanical test set-up consisted of:

- Support equipment (loading fixtures) to introduce the required loads into the test article at selected interfaces:
 - a) CMA Loading Fixture
 - b) Propellant Tank's Loading System
 - c) Main Engine Loading System
- A total of **27 Hydraulic jacks** have been installed to apply load components on the loading fixtures. Up to 22 jacks were used simultaneously for the more complex test cases.

The test setup was complemented by a set of instrumentation (strain gauges and displacement transducers) and a Data Acquisition System to acquire the data from the test instrumentation and provide them in real time to test engineers during the test execution.

A total of **139 displacement transducers** (113 on ESM + 26 on CMA) to measure deformation and distortions during the load application and **316 acquisition channels for strain gauges** (184 mono-axial, 44 biaxial and 29 rosettes) were installed on the test article to monitor the strain readings and to convert the data to the corresponding stresses at those locations.

Pictures of the S-STA1 test setup with the supporting frame are shown in figures 16, 17 and 18.

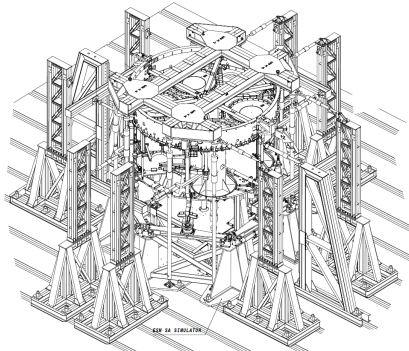

Figure 16. S-STA1 test setup drawing

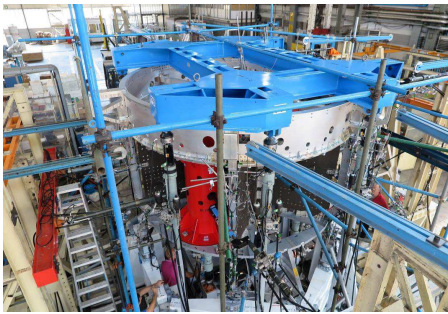

Figure 17. S-STA1 test setup

A total of 10 stiffness test cases have been performed:

- ESM global stiffness (6 load cases): DESIGN LIMIT level unitary loads at (FX, FY, FZ) and moments (MX, MY, MZ) applied at CMA interface
- propellant tanks mounting I/F stiffness (1 case): DESIGN LIMIT level unitary axial load (FX) applied on one tank
- Main Engine mounting I/F stiffness (3 cases): DESIGN LIMIT level unitary loads (FX, FY, FZ) applied at Main Engine interface

A total of 5 strength check cases have been performed with the aim of introducing significant stress in the structure to verify load paths and check for any anomaly in the ESM assembly.

Test engineers evaluated the sensors readings during the test to check in real time for any discrepancy with respect to test predictions (based on FEM analysis of STA1 configuration).

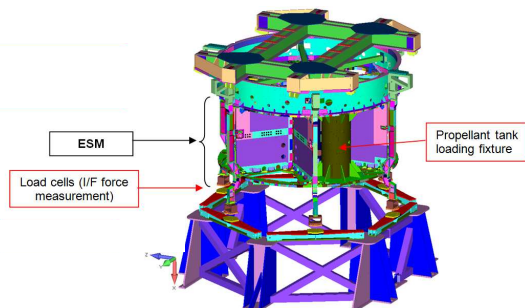

Figure 18. S-STA1 stress FEM

The ESM structural test article stress, displacement, interface forces was checked and any anomaly detected during test results readings was investigated by inspecting the test article and instrumentations (e.g. potentially failed/misplaced sensors or inverted sensors channels on the DAS), or even by FEM correction (mesh quality, coherence with hardware, representativeness of features like bolted connections) or by test predictions correction (typing errors). Overall behavior (displacement and strain) was generally in line with predictions and linear up to 100% of the applied test loads. Some discrepancies have been found and they have been worked out during model correlation activities.

ESM FE Model was finally validated against test measurements.

STA1 test allowed to correlate as well the CMA simulator (as provided by Lockheed Martin)

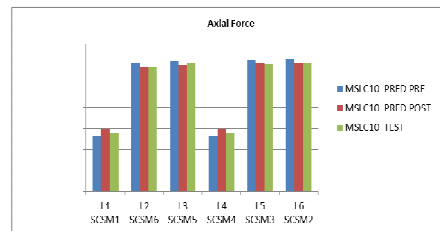

Figure 19. S-STA1 Typical force distribution at the base of the longerons before and after FEM correlation

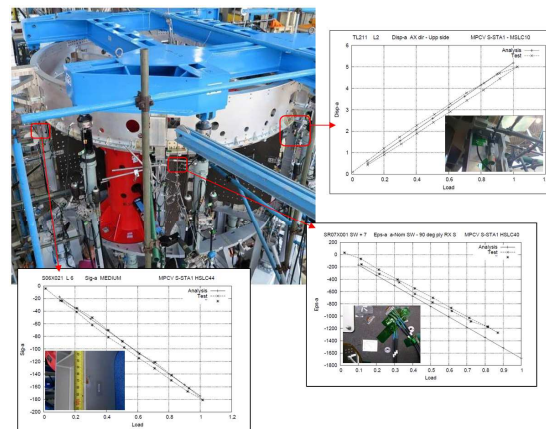

Figure 20. S-STA1 Typical plot "measurement vs predictions" for stress and displacement at few ESM locations

The performed test campaign was fully successful:

- it allowed to demonstrate design compliance to requirements,
- it showed a general consistency between predictions and measurements (load path, stress distribution),
- it provided information for FEM correlation activities and achievement of test success criteria.
- it provided information about areas for potential design improvement

4.2. STA-2 Test Campaign Summary

A test campaign has been performed on a qualification model (S-STA2) of the ESM primary structure with the following objectives:

- Support the following verification of Structure Subsystem requirements:
 - Static qualification test performance
 - Ability to sustain applicable loads
 - Transmit launch loads
 - Sustain the load from the distancing system
 - Minimum margin of safety for metallic and composite parts
 - Pitch and Yaw actuator mounting I/F stiffness
- Verify global load path and stress distribution allowing the final validation of the structure FEM.

The STA2 structure hardware was fully representative of (identical to) the Flight Unit in terms of parts, interfaces, manufacturing processes and fasteners. Composite panels included all features (cutouts, discontinuities, inserts for equipment even if not necessary to be loaded during the test) of the flight hardware.

STA2 test article included also all latest design and loads modifications mandated by the project after STA1.

Pictures of the S-STA2 test article are shown in figure 21.



Figure 21. S-STA2 test article

For STA2, the test setup was significantly more complex than STA1 due to a huge number of load introduction points and the various locations to be monitored for stress and displacement.

Additional simulators, in particular for the secondary structures, have been introduced as compared to the STA1 test campaign to allow correct introduction of loads into primary structure interfaces with the secondary structures to reach the required stress level on various part of the ESM primary structure, needed to achieve strength verification.

The STA2 mechanical test set-up consisted of:

- support equipment (loading fixtures) meant to introduce the required loads into the test article at selected interfaces:
 - CMA Loading Fixture
 - Propellant Tank's Loading Fixture
 - Main Engine Loading Fixture
 - Water tanks Loading System
 - Helium tanks Loading Fixture
 - UPC payload loading Fixture
 - Radiator interfaces Loading System
 - RCS Thruster Pods interfaces loading System
 - Separation Springs Loading Fixture
 - Solar Array loading Fixture
 - Thrust Vector Control interfaces loading Fixtures
- A total of **72 Hydraulic jacks** have been installed, to apply various load components on the loading fixtures. Up to 52 jacks were used simultaneously for the more complex test cases.

Pictures of the S-STA2 test setup are shown in figures 22 thru 24.

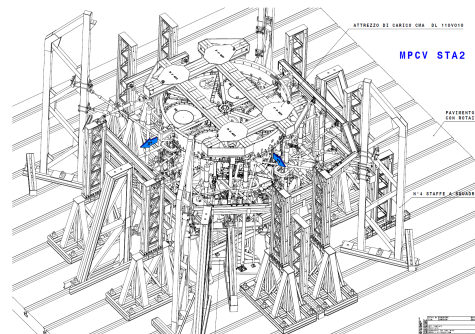

Figure 22. S-STA2 test setup drawing

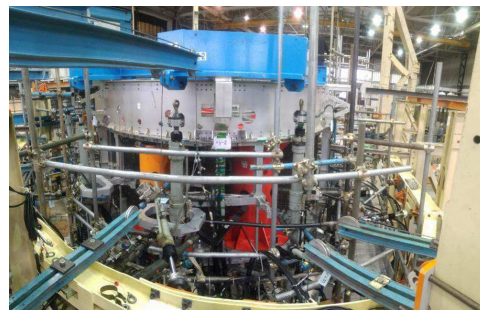

Figure 23. S-STA2 test setup



Figure 24. S-STA2 test setup (bottom view)

The test setup was complemented by a set of instrumentation (strain gauges and displacement transducers) and a Data Acquisition System, to acquire the data from the test instrumentation and provide them in real time to test engineers during the test execution.

A total of **71 displacement transducers** (56 on ESM + 15 on CMA) to measure deformation and distortions during the load application and **438 acquisition channels for strain gauges** (428 mono-axial, and 5 biaxial) were installed on the test article to measure stress.

A total of 12 test load cases (8 Global and 4 Local), covering 52 Failure Modes, have been defined with the aim of reaching limit and ultimate loads in various parts of the structure to achieve structural qualification.

- **QSLC11** (Tank Bulkhead strength and main interface vs Webs Assembly)
- **QSLC21** (Tank Bulkhead and main interface vs Solar Array secondary structure)
- **QSLC30** (Longerons and main interface vs Webs Assembly)
- **QSLC40** (Longerons strength)
- **QSLC50** (Lower Platform and main interface vs Solar Array secondary structure)
- **QSLC60** (Webs Assembly Square Tube Panels)
- **QSLC70** (Webs Assembly Shear Panels)
- **QSLC80** (Webs Assembly Shear Panels)
- **QSLC90** (Main Engine Support)
- **QSLC200a** (upper Radiator brackets interface)
- **QSLC200b** (lower Radiator brackets interface)
- **QSLC201** (RCS Thrusters PODS interface)

All these load cases have been run up to the limit load levels. As yielding can occur while going to the ultimate loads, the number of cases which could be run up to ultimate (qualification) level had to be limited. Nevertheless, by optimizing the test sequence, test engineers were able to maximize the number of cases verified up to qualification level: 9 test cases, representing 40 Failure Modes, over 12 were brought up to Ultimate loads.

For other cases, representing 12 Failure Modes of the 52, the measurement data collected were enough to allow FE Model validation and to reach final qualification levels by the correlated FEM based on test.

Typical charts of predictions vs measurements, including few examples of FEM correlation, are shown in figure 25 thru 27.

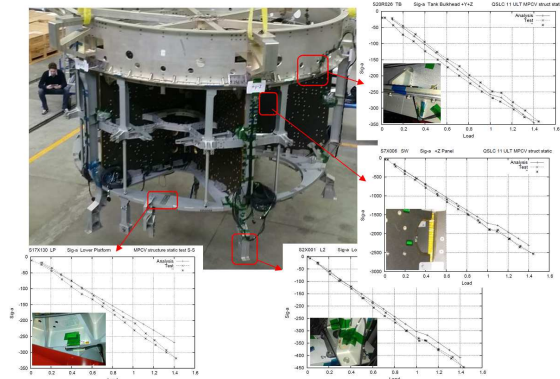

Figure 25. S-STA2 Typical plot “measurement vs predictions” for stress

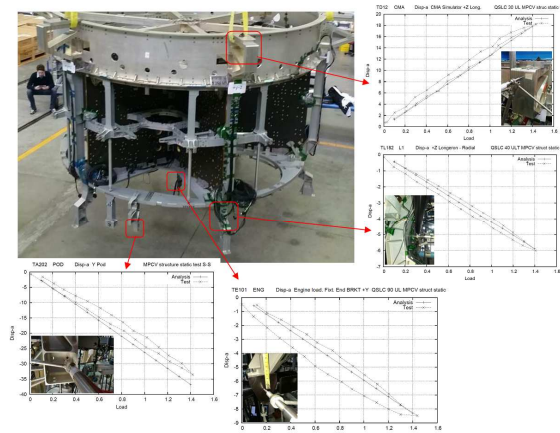

Figure 26. S-STA2 Typical plot “measurement vs predictions” for displacement

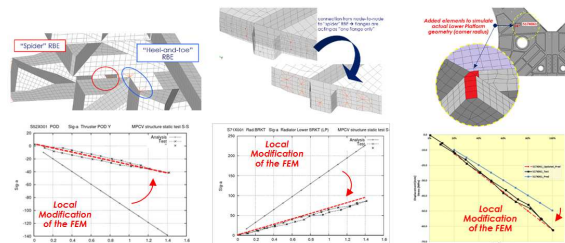

Figure 27. S-STA2 Typical plot “measurement vs predictions” for displacement

Complementary to strength verification cases, two stiffness test cases (not previously covered by STA1) have been also performed on STA2 test article:

- TVC Pitch actuator interface stiffness: tested at DESIGN LIMIT level load (along actuator direction)
- TVC YAW actuator interface stiffness: tested at DESIGN LIMIT level load (along actuator direction)

Stiffness at TVC actuator interfaces has been found similar or slightly better than the minimum requirement.

The STA2 test campaign was fully successful: no detrimental deformation has been observed at Limit Load level and no structural failure has been detected during qualification/ultimate load application.

The performed tests allowed to demonstrate design compliance to requirements, showed a consistency between predictions and measurements (load path, stress distribution), providing information for final FEM correlation activities and allowed the confirmation or updating of the structure margins of safety.

Based on test results exploitation and the subsequent analytical work, the ESM structure was confirmed to be able to withstand the applicable flight loads with relevant safety factors.

These successful test campaigns have been the basis for achieving a significant milestone in the ESM project: Structure Subsystem QR which has declared the ESM structure design fully satisfactory with respect to the applicable structural requirements.

5. CONCLUSIONS

The European Service Module of the NASA Orion Spacecraft is developed and qualified/verified by the European Space Agency with Airbus Defense & Space as the prime contractor.

The ESM Structure Subsystem, including the MMOD protection system, is designed and manufactured by Thales Alenia Space Italia (TAS-I).

The ESM Structure Subsystem Development has been based on a building block approach, from coupon testing (for CFRP material characterization) up to breadboard testing of main structural components and joints.

The ESM Structure Subsystem Qualification has been based on two test articles, representative of flight hardware in terms of design and manufacturing processes:

1. STA-1:
used for early static tests and models validation and correlation. Test performed mid-2015.
It has undergone a static test to verify the stiffness requirements and get early validation of the mathematical model for stress/strength analysis
2. STA-2
used for Structural Qualification (Limit and Ultimate Static Test). Testing was performed on February/March 2017.
It has been used for the structural qualification of the structure sub-system reaching up to ultimate loads, in order to verify all the structural strength requirements and get full validation of the mathematical model for stress/strength analysis and finally confirm the structural design margins of safety

ACKNOWLEDGEMENTS

All parties involved (TAS-I, Airbus, ESA, NASA, Lockheed Martin Corporation) has provided a significant and valuable contribution in such achievement, thanks to their technical competence and teamwork.

Mechanical teams from companies and agencies were all involved and supporting the ESM structural qualification since the test definition phase up to the test attendance, the test data exploitation and analysis and issues resolution.

Test facility engineers and technicians were a pillar for meeting the test success criteria within the tight project schedule.

This close cooperation, together with a highly dedicated team (including design engineers, test engineers, test laboratory technicians, manufacturing workers) were key contributors to the success of ESM structural qualification.



6. REFERENCES

1. MIL-HDBK-17/1F, Department Of Defense Handbook: *Composite Materials Handbook - Polymer Matrix Composites Guidelines For Characterization - Vol. 1, Chapter 2.*