



Evaluation of a Variable Thickness Hybrid Composite Bull Gear

Kelsen LaBerge (ARL)

Joel Johnston (USRA)

Robert Handschuh (NASA GRC)

Gary Roberts (NASA GRC)

May 16th, 2018 – AHS Forum 74



- **Motivation**
- **Background**
- **Past efforts**
- **Bull gear design**
- **Static Torsion Experiments**
- **Dynamic and Endurance Experiments**
- **Conclusions**
- **Future work**



- Reducing drive system weight is always desired
- Future Vertical Lift platforms are expected to have increased speed, range, and payload requirements
- Advanced vertical lift platforms require the ability to change rotor speed to satisfy these requirements
- Multi-speed transmission components increase transmission weight and complexity
- **Hybrid (composite/steel) gears are being investigated as a technology to enable weight neutral multi-speed transmissions**



What is a Hybrid Gear?

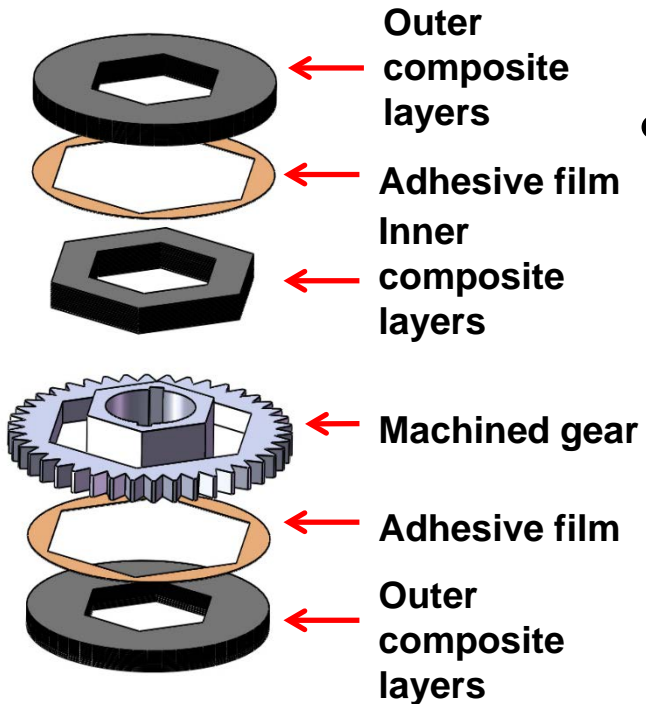
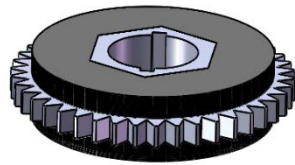

- Replaces steel gear web with lightweight carbon fiber composite
- Loads transferred through adhesive bonds, mechanical interlocks, or fasteners (or any combination)



U.S. ARMY
RDECOM

UNCLASSIFIED

Past Hybrid Gear Efforts



Endurance and dynamic experiments



Loss-of-lubrication experiments

Small-Scale Experiments

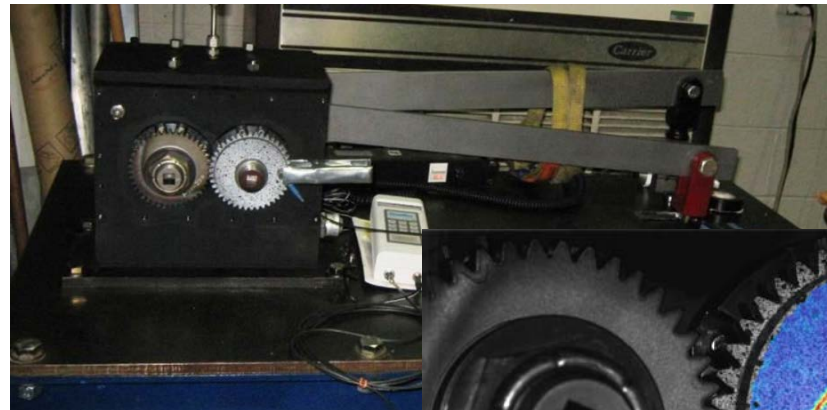

Static torsion experiments

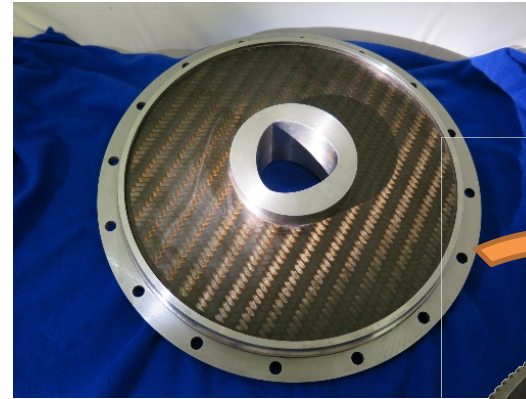
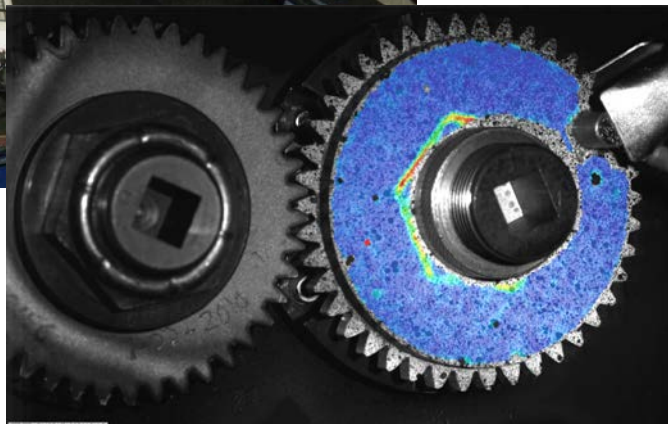

Dynamic and endurance experiments (limited to 3300 hp in previous configurations)

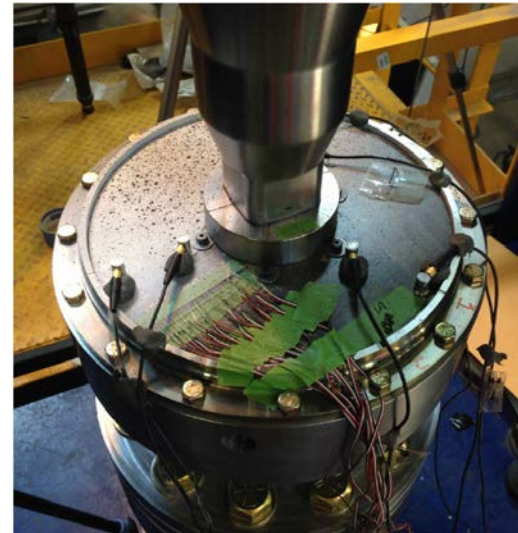

Static torsion experiments

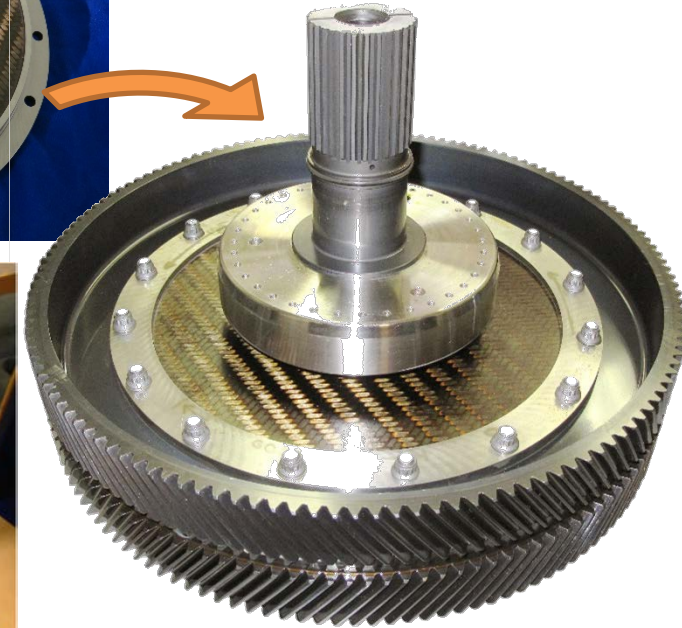

Full-Scale Bull Gear Experiments



U.S. ARMY
RDECOM

UNCLASSIFIED

Variable Thickness Bull Gear Design



Exploded View of Hybrid Web

Composite Sections



Metallic Adapters

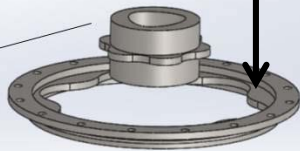

Composite Section

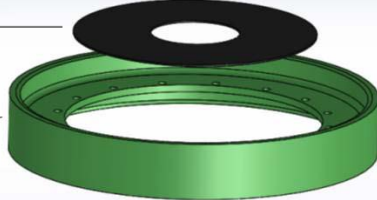

Existing Bull Gear

Torque Transfer Mechanisms

Mechanical interlock

Adhesive bond at axial steel/composite interface
(Cytec MTA-241 film adhesive)

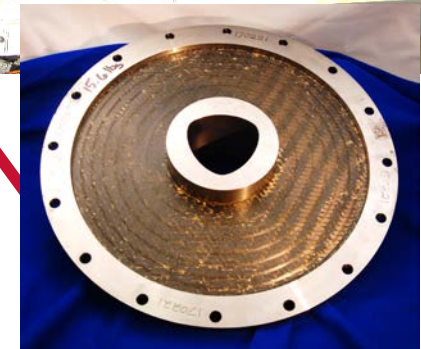
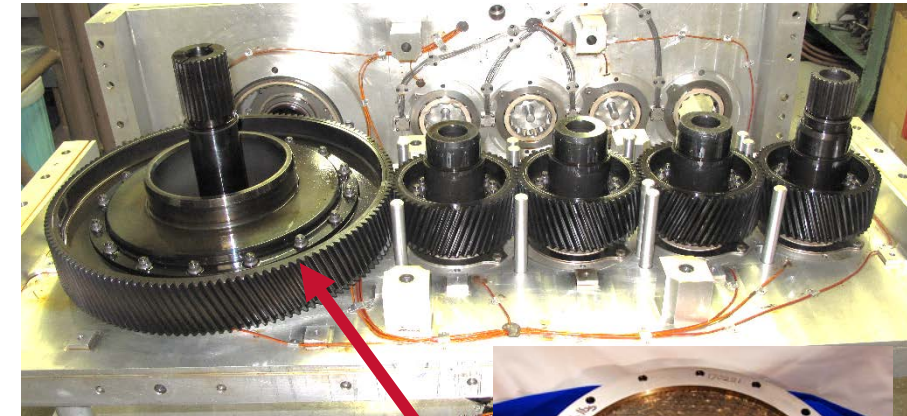

Triaxial Braid Architecture

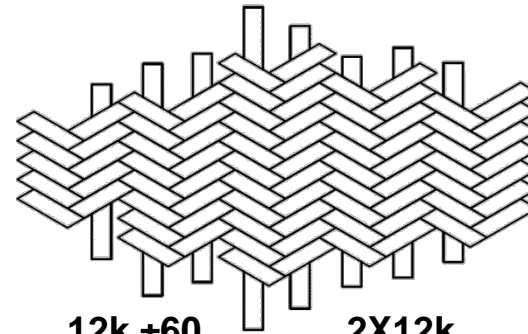

12k ±60
bias yarns

2X12k
axial yarns

A&P Technology

Braided prepreg composite information

- T-700 SC carbon fibers
- Prepreg 0°, +/- 60° braided architecture
- Equal fiber volume in all directions
- Tencate TC-250 resin with 56% fiber volume

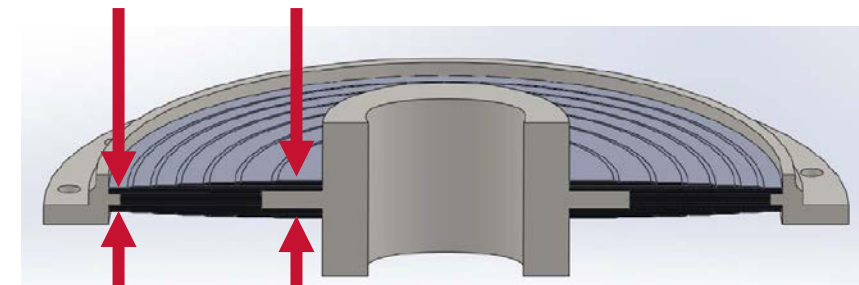

0.417 in

0.667 in

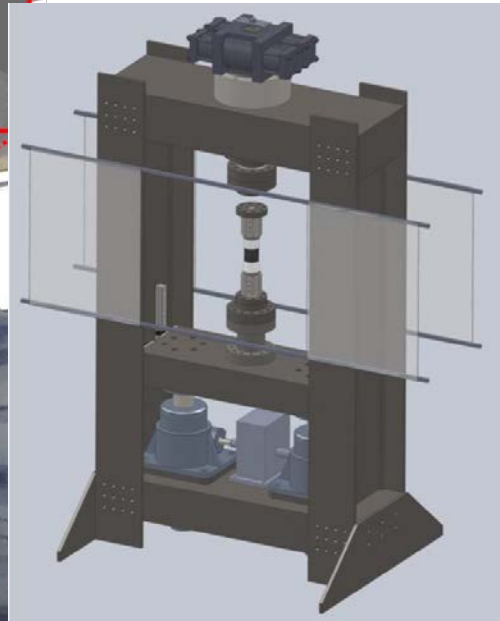
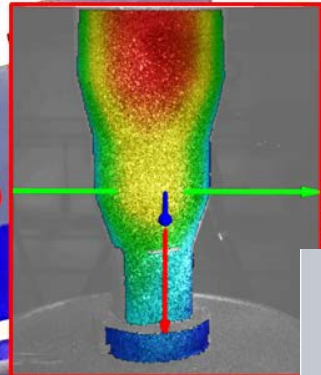
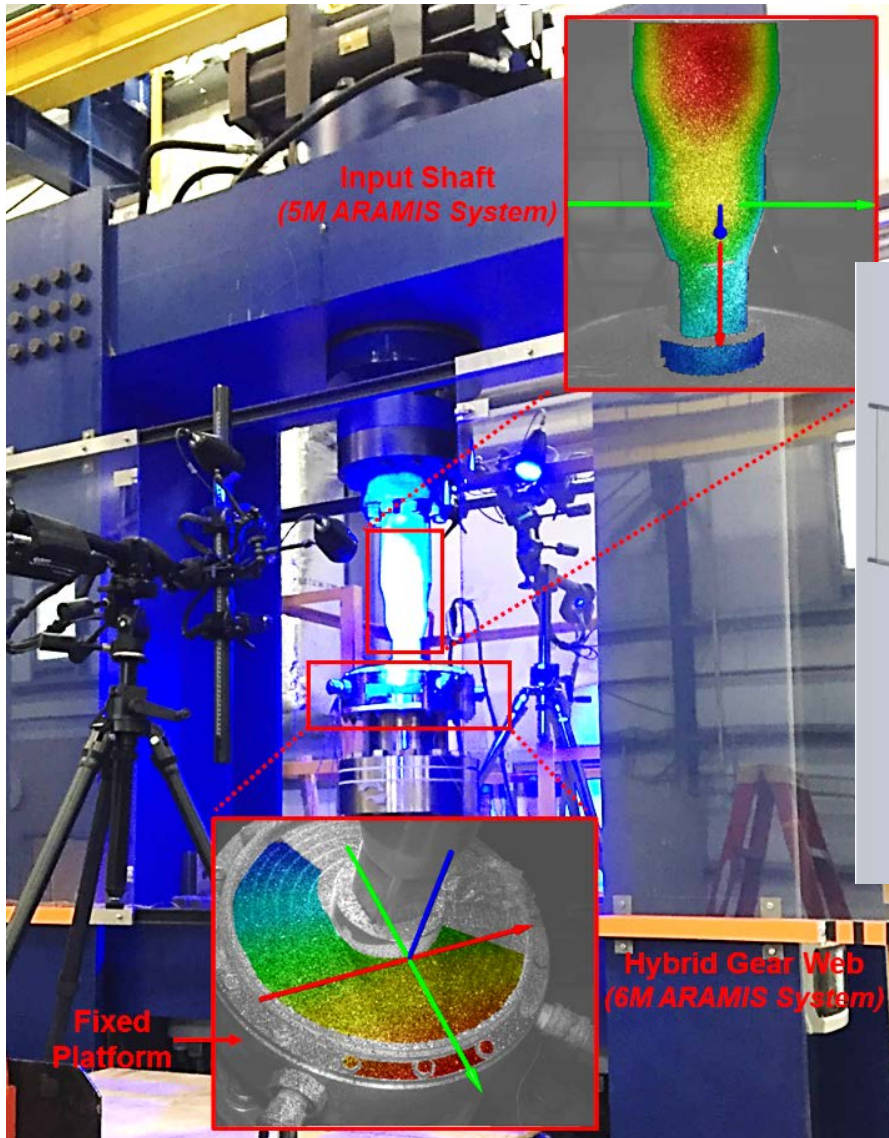

Equipment

- 90° rotational range
- Maximum torque of 240,000 in-lb (27,100 N-m)
- Outer flange held stationary
- Shaft used to apply torque through a square polygon
- 0.2°/min rotation applied through a hydraulic rack and pinion actuator
- Torsion increased until failure or maximum torque is reached

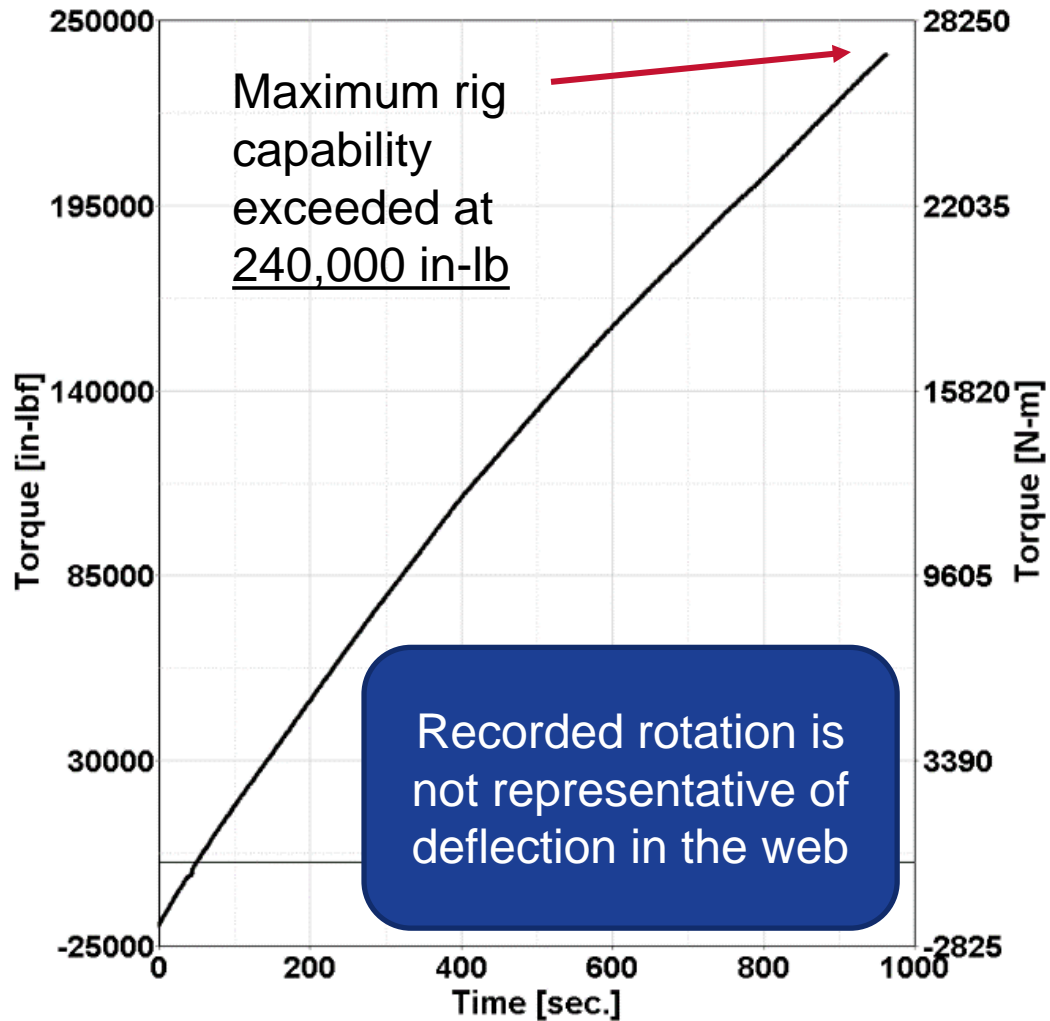

- Experiment discontinued after maximum rig capability was reached

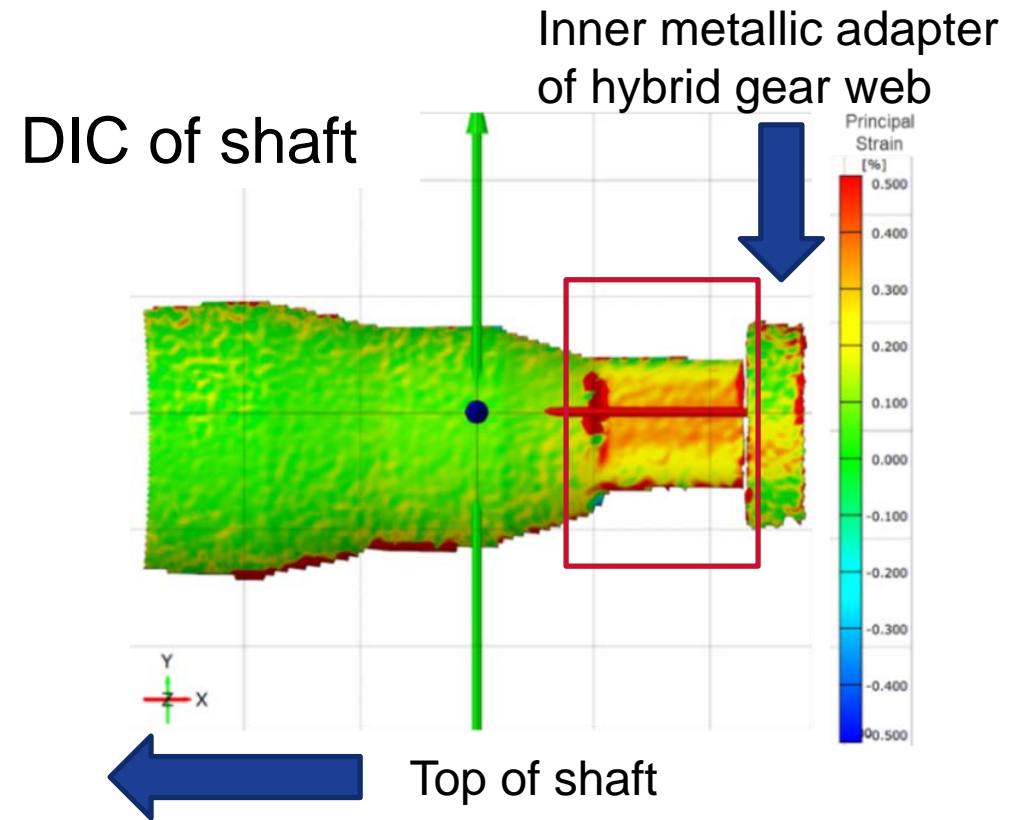



U.S. ARMY
RDECOM

UNCLASSIFIED

Results – Static Torsion Experiment

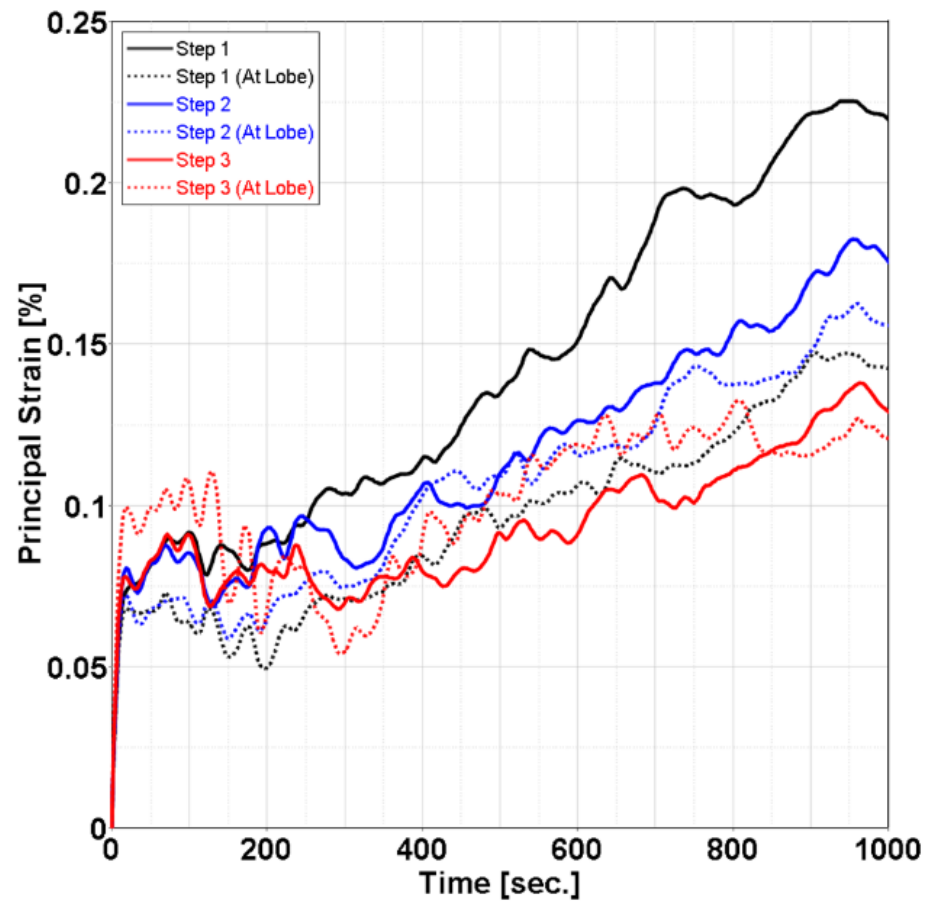
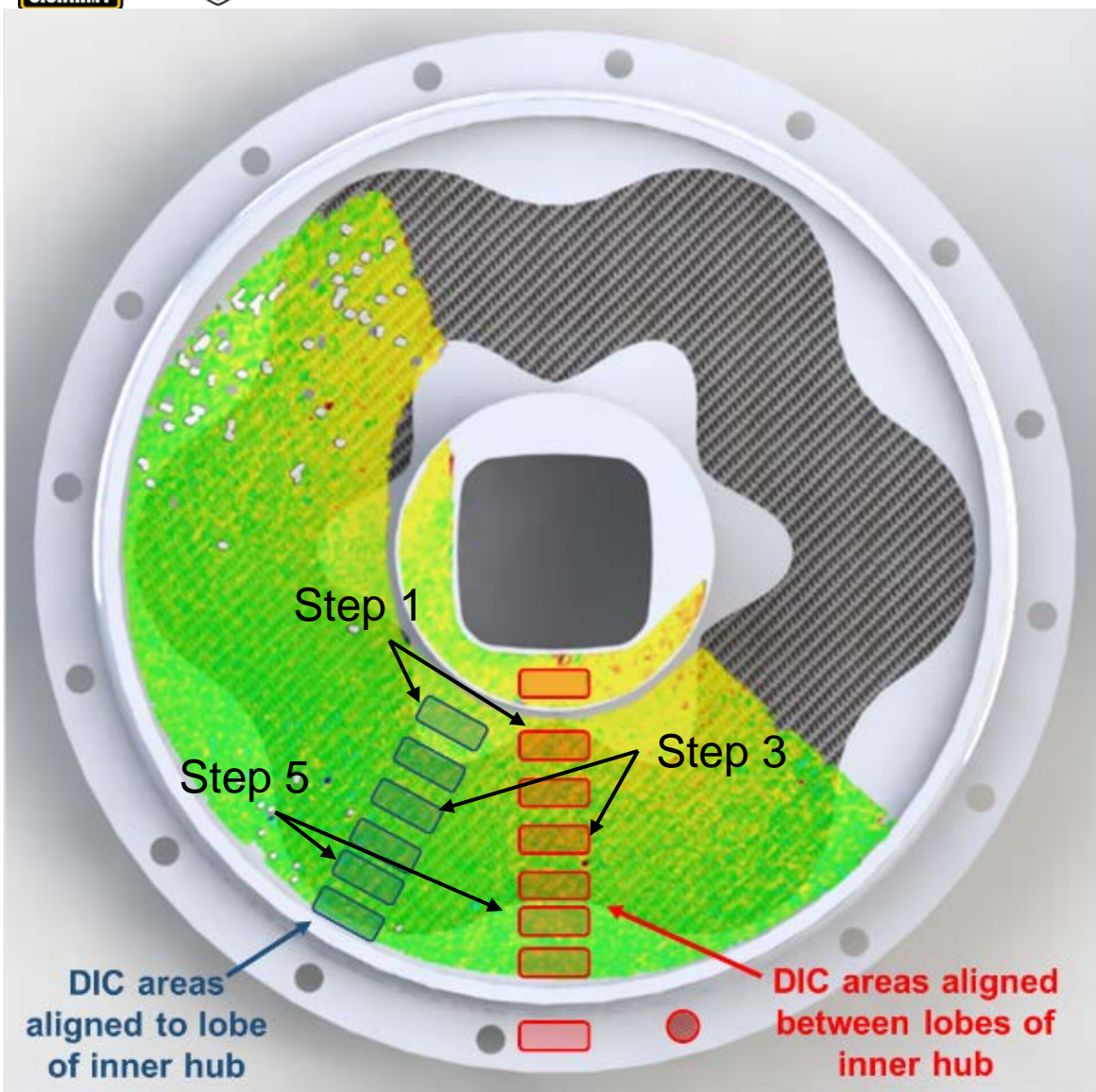

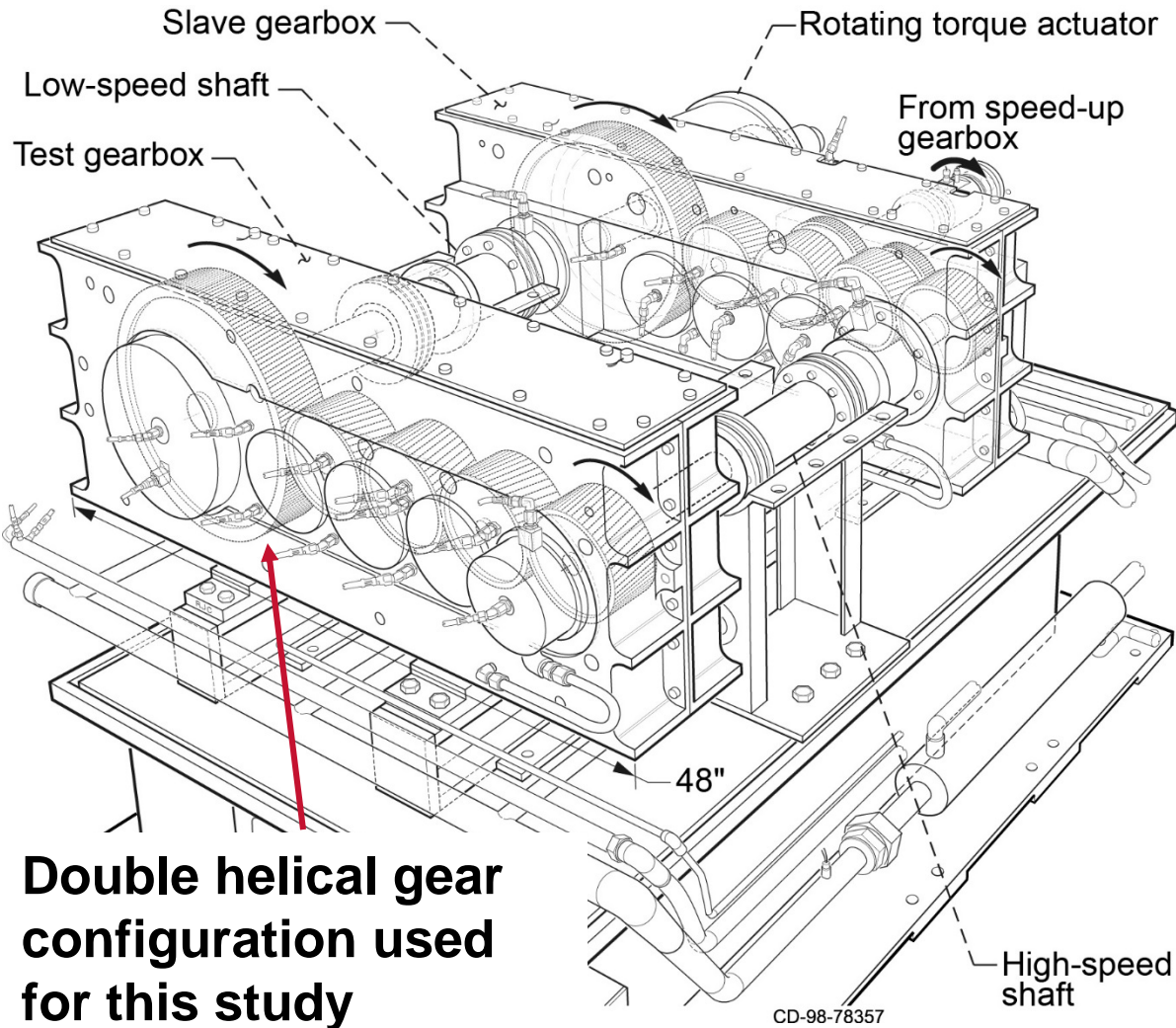

Double helical gear configuration used for this study

High-Speed Helical Gear Train Rig at NASA Glenn Research Center

• Rig Capabilities

- Max Power: 5000 HP
- Input Pinion: 15,000 RPM at 21,000 in-lbs
- Bull Gear: 5475 RPM at 58,400 in-lbs
- Up to 250°F oil inlet temperature

• Instrumentation

- Axial and radial vibration monitoring at bull gear bearing housing
- Proximity sensors for monitoring bull gear orbit
- Thermocouples at several locations

- Oil Inlet Temperature: 120°F



U.S. ARMY
RDECOM

UNCLASSIFIED

Results – Dynamic Experiment



Condition Number	Speed RPM	Torque in-lb (N-m)	Power hp (kW)
1	900	5000 (570)	70 (50)
2	900	10000 (1130)	140 (110)
3	900	15000 (1700)	210 (160)
4	1800	5000 (570)	140 (110)
5	1800	10000 (1130)	290 (210)
6	1800	15000 (1700)	430 (320)
7	2700	5000 (570)	210 (160)
8	2700	10000 (1130)	430 (320)
9	2700	15000 (1700)	640 (480)
10	3600	15000 (1700)	860 (640)
11	3600	19300 (2180)	1100 (820)
12	4500	19300 (2180)	1380 (1030)
13	4500	38600 (4360)	2760 (2060)
14	4500	58400 (6600)	4170 (3110)
15	5400	19300 (2180)	1650 (1230)
16	5400	38600 (4360)	3310 (2470)
17	5400	58400 (6600)	5000 (3730)

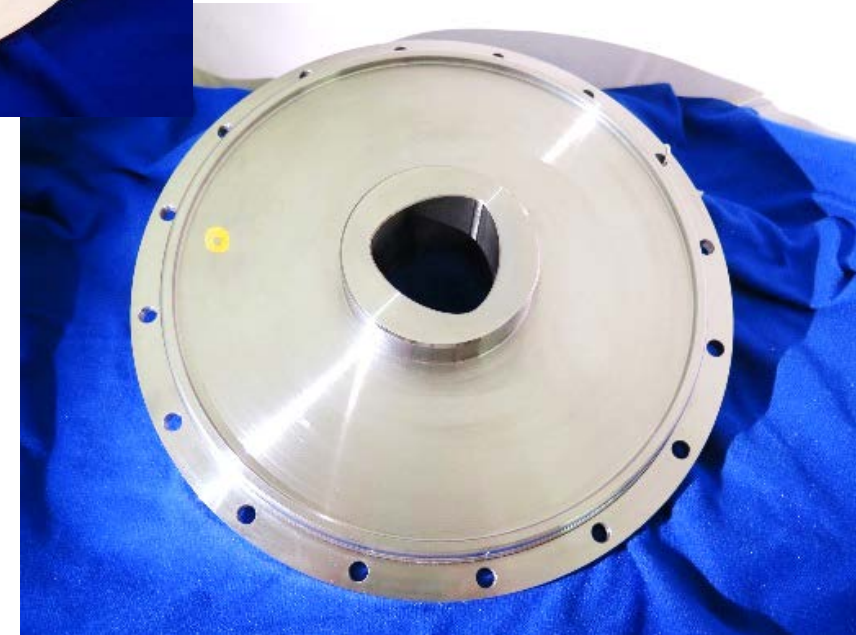
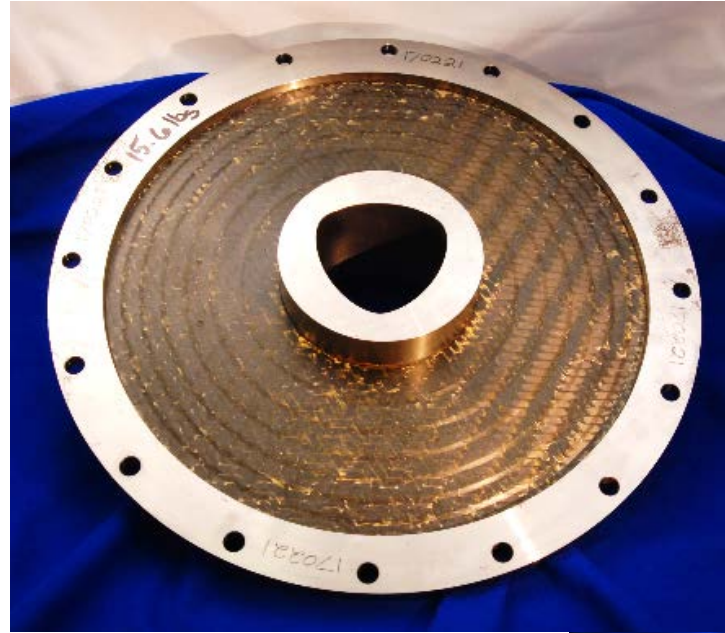



RMS Vibration Level

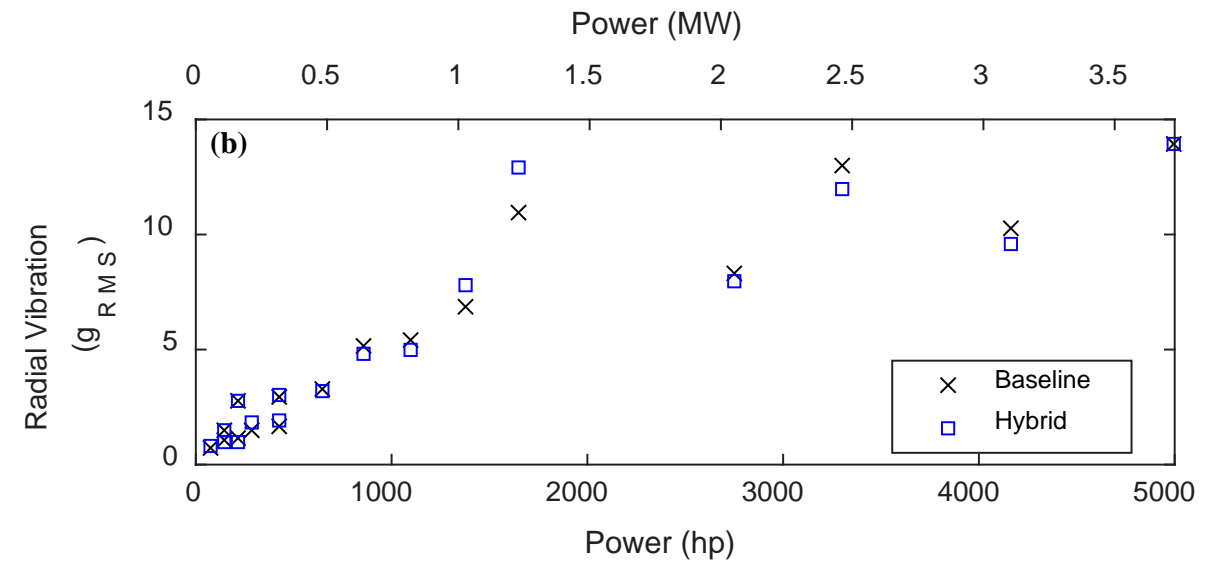
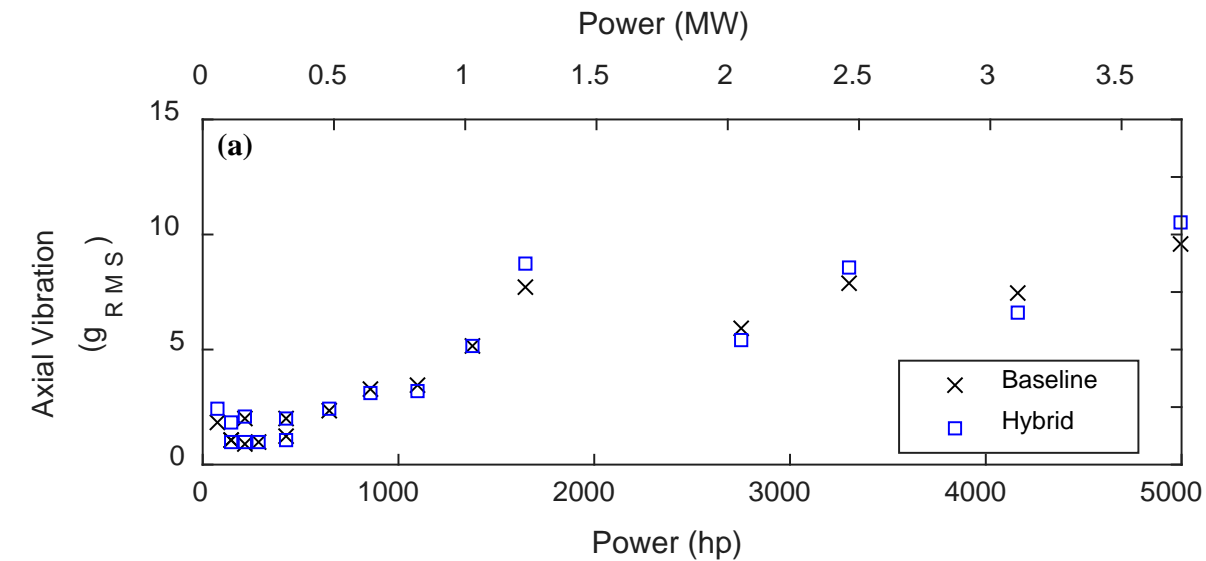



Results – Dynamic Experiment



Mesh Frequency Magnitude Time Synchronous Averaged Signal

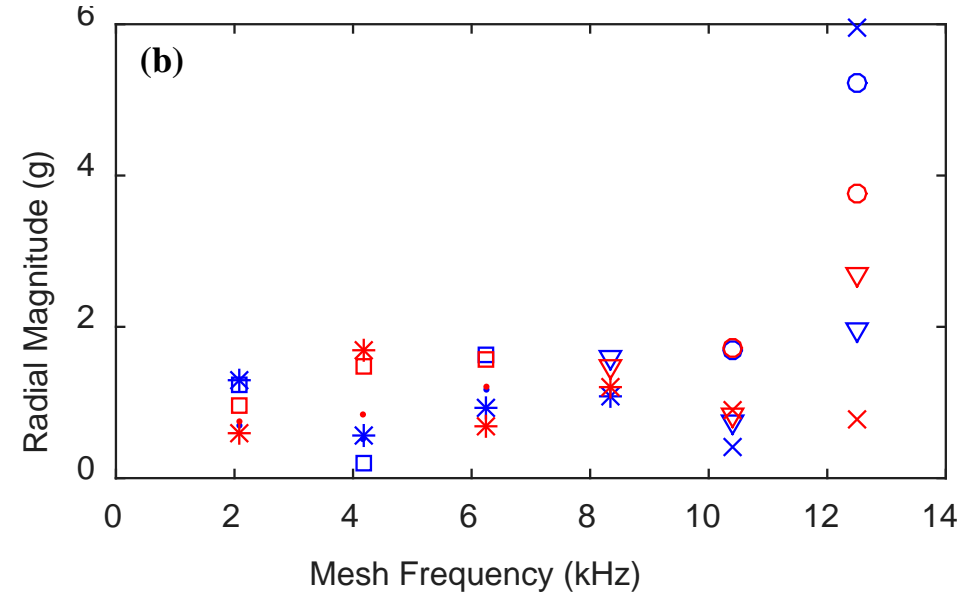
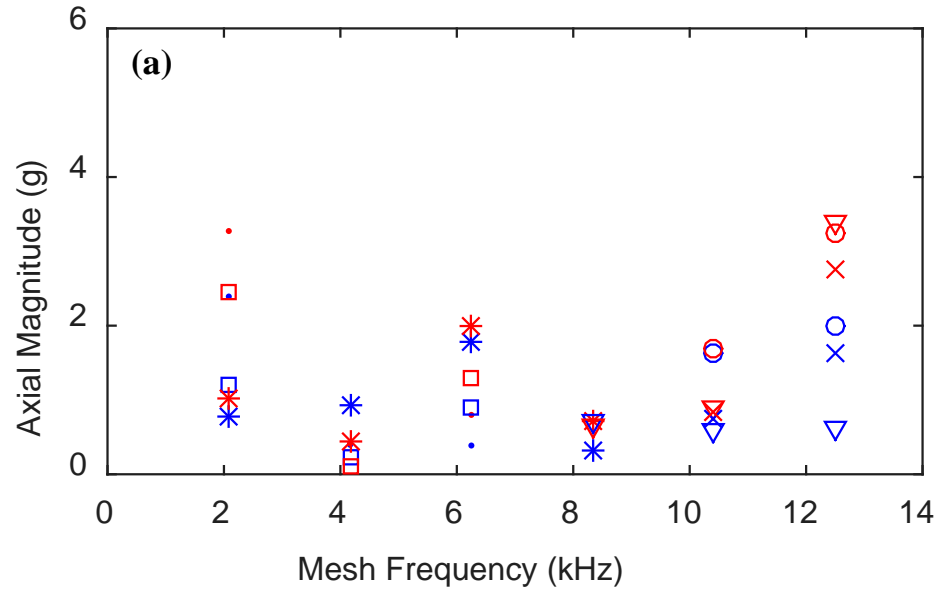

- Baseline - 5000 (in-lb)
- Hybrid - 5000 (in-lb)
- Baseline - 10000 (in-lb)
- Hybrid - 10000 (in-lb)
- * Baseline - 15000 (in-lb)
- * Hybrid - 15000 (in-lb)
- ▽ Baseline - 19300 (in-lb)
- ▽ Hybrid - 19300 (in-lb)
- × Baseline - 38600 (in-lb)
- × Hybrid - 38600 (in-lb)
- Baseline - 58400 (in-lb)
- Hybrid - 58400 (in-lb)



Temperature Differential

$$\Delta T = T_{\text{bull_fling}} - T_{\text{oil_inlet}}$$

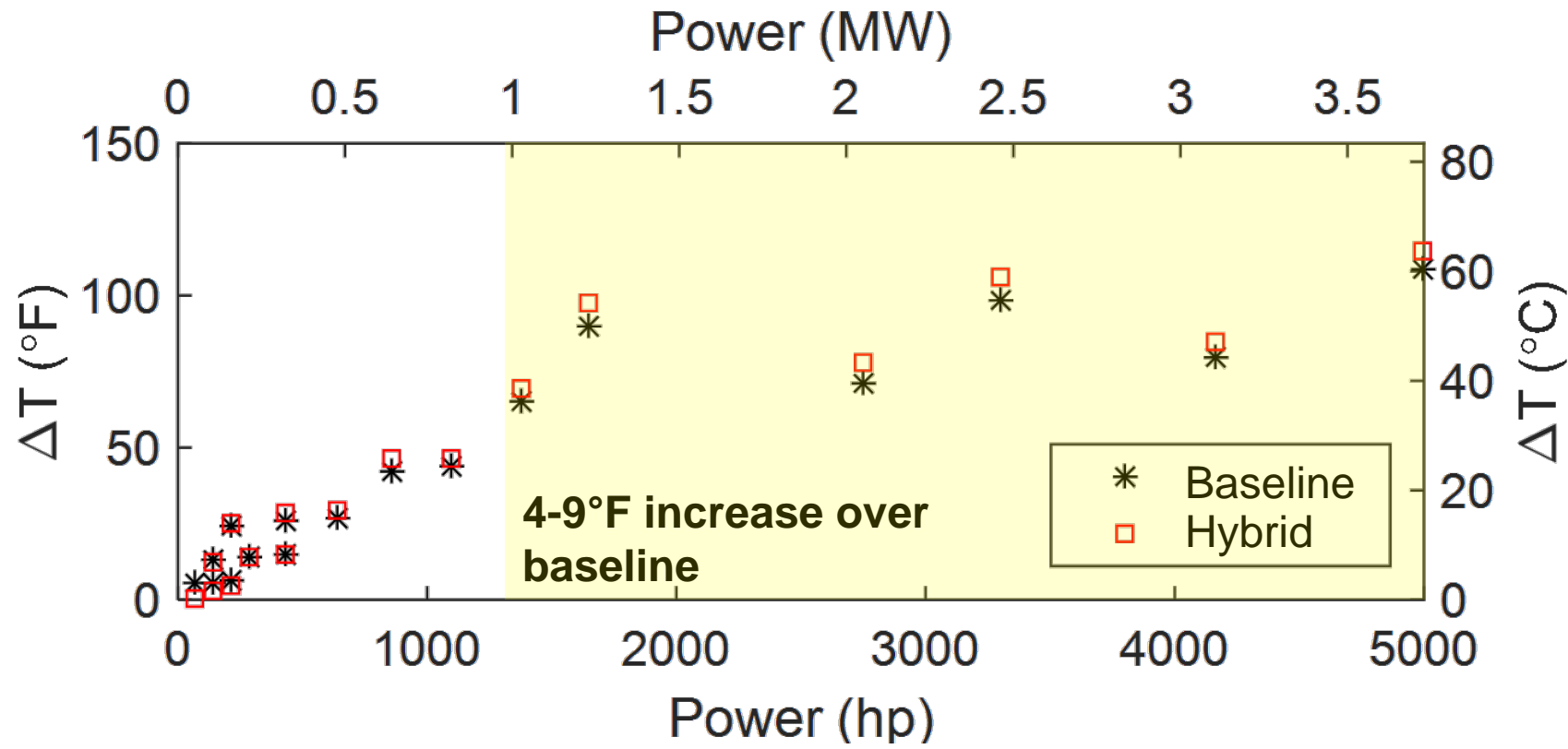



Results – Endurance Experiment



- **Goal – To accumulate a million cycles at full power (5000 hp)**

Gear Orbit

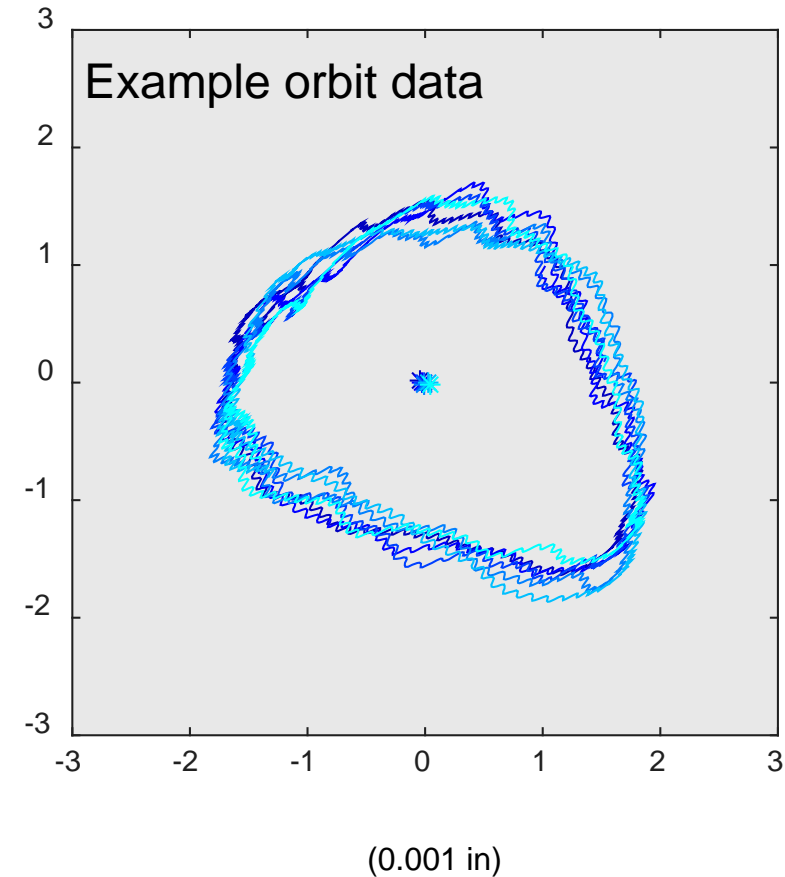



Results – Endurance Experiment



- **Goal – To accumulate a million cycles at full power (5000 hp)**

Experiment discontinued after ~530,000 cycles at 5000 hp

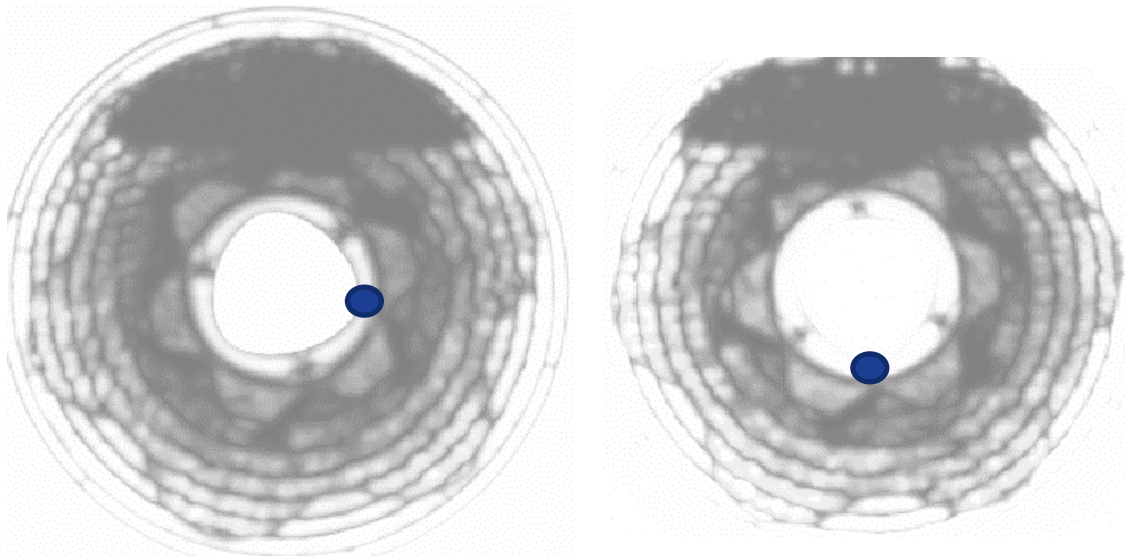

Gear Orbit

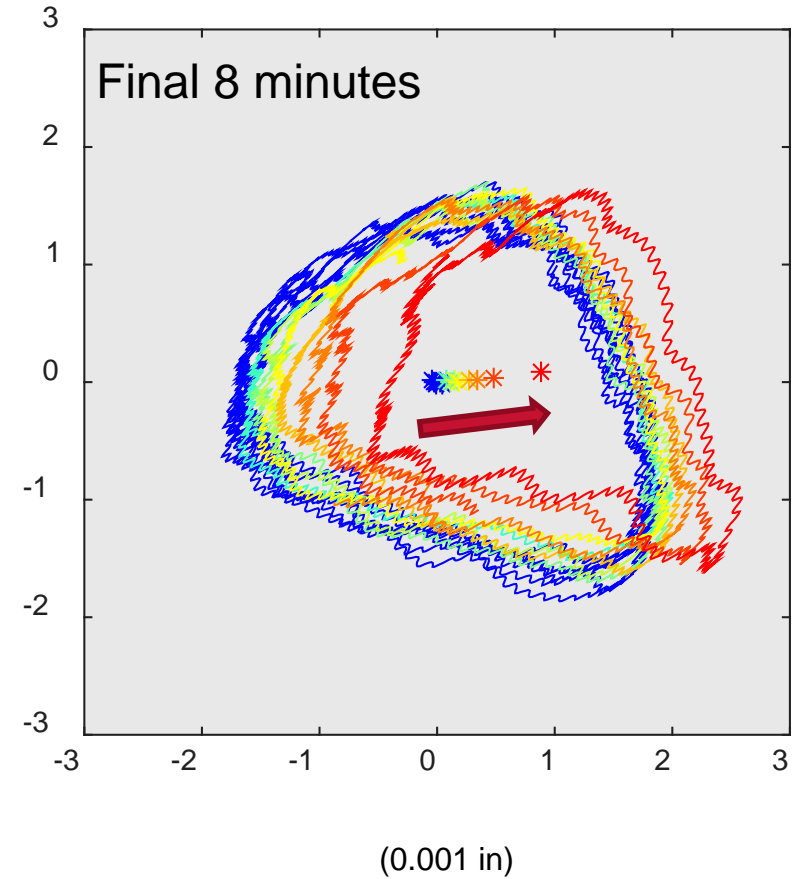

- Test article axial flange offset by 0.0625 in.
- First assembly attempt resulted in a gearbox that could not be rotated by hand
- Modifications made to eliminate the problem

Unexpected axial loading during the experiment may be the source of the increase in fling off temperature.

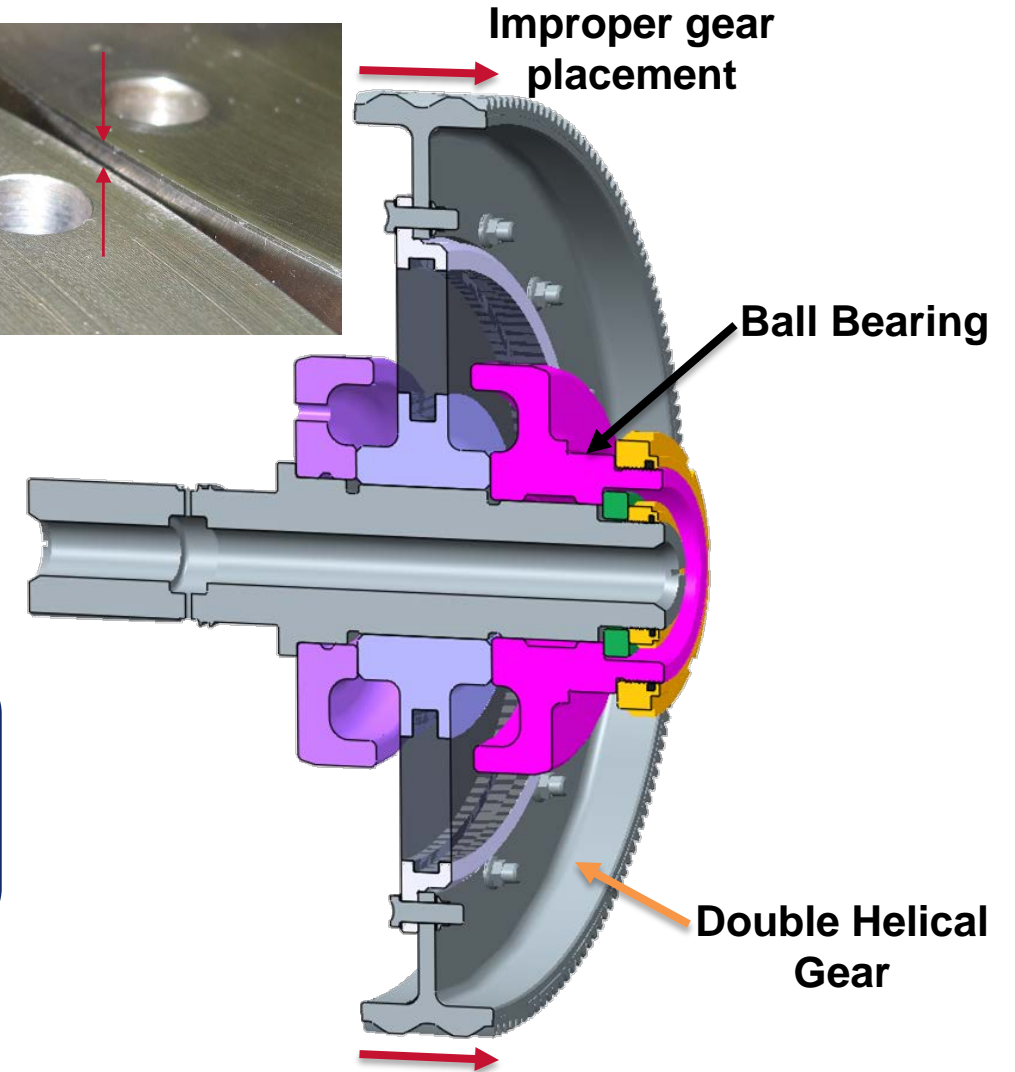
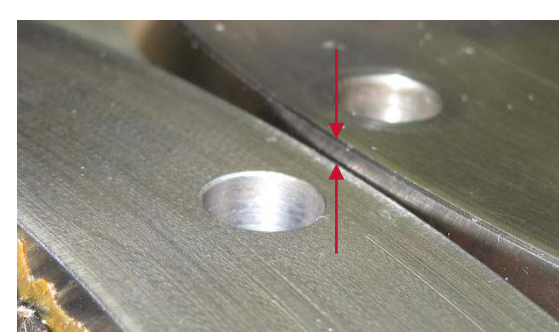



Conclusions



- **Variable thickness hybrid gear design far exceeded performance of previous designs in static torsion experiments**
- **Hybrid gears can be used for high-power applications up to 5000 hp**
- **Vibration during the variable thickness hybrid gear experiments was comparable to baseline experiments**
- **The design is sensitive to axial loading**
- **While a failure occurred, it was benign in nature and did not result in a loss of torque or damage to other major rig components**



- **The authors plan to repeat these experiments with a gear of the same design (without axial flange offset)**
- **DIC data from static torsion experiments is being used to validate a finite element model of the gear web**
- **An all composite web is being designed to eliminate the metallic adapters**



Questions?

Acknowledgements:

- **A&P Technology** 
- **Sig Lauge – Technician support**
- **NASA Revolutionary Vertical Lift Technology**