

# Acoustic Directivity of the DGEN Aero-propulsion Research Turbofan at Multiple Farfield Array Locations

Dan Sutliff / LTV / GRC

AIAA Aviation Forum

26-June-2018

National Aeronautics and Space Administration  
Aeronautics Research Mission Directorate  
Advanced Air Vehicles Program  
Advanced Air Transportation Technology Project  
Aircraft Noise Reduction Technical Challenge



# OUTLINE

- I) DART Overview
- II) Baseline Data
  - a) Spectral Content
  - b) Repeatability
- III) Symmetry
  - a) Circular Array
  - b) Linear Array
- IV) Conclusion



# I) DART Overview

# DGEN380 Turbofan Engine

2 spool, geared fan (3.32 ratio), unmixed, separate flow exhaust  
 Centrifugal compressor, LP turbine (43,000 rpm), HP turbine (52,000 rpm)  
 14 inch diameter fan, 14 fan blades (13,000 rpm)  
 Thrust 560 lbf, 7.6 BPR, 1.2 FPR, 5.3 OPR, 28.7 lb/s  
 Inlet mass flow,  $V_{tip} = 785$  fps subsonic tip speed

## GEARED-DOWN FAN

Wide chord blades  
casted fan

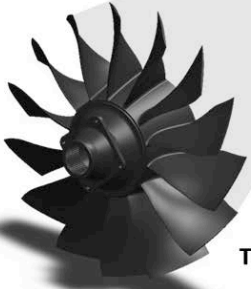

14 blades

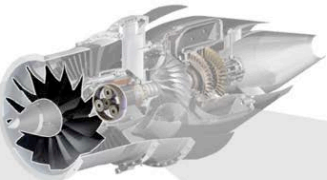

Epicyclical Gearbox with  
rafters



Ratio: 3.32

The Low Pressure Spool consists of:

- LP turbine and LP shaft (43'000 rpm)
- Gearbox
- Fan (13'000 rpm)

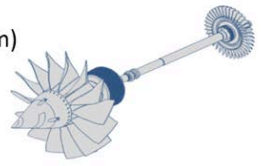

Low component count/easy disassembly  
 Drawings Available



# Background

April 2017 DART entry at “ANCF” location provided installation checkouts and baseline acoustic/performance data.

## A 2<sup>nd</sup> entry occurred to accomplish several goals:

- 1) Operate DART in center location (relocated cabling/fuel, etc)
- 2) Evaluate an existing noise reduction technology.  
Limited time frame & need experience (walk before run)
  - a. MDOF liner (NIT/GFIT/ANCF/9x15 – *flight test?*)
  - b. Inlet (limits potential of attenuation – validate predictions)
- 3) **Evaluate symmetry of acoustic directivity and add linear array in preparation for potential 9x15/14x22 WT entries.**
- 4) **Compare fixed arrays (10ft arc, 88” linear) to overhead array (impact of PBS farfield).**
- 5) Develop work flow for incorporating DART standard acoustic data into DADS.
- 6) Obtain limited performance op line information.
- 7) Establish research/operational procedures and polices.

**Testing occurred in Apr, Aug 2017**



# DART in AAPL

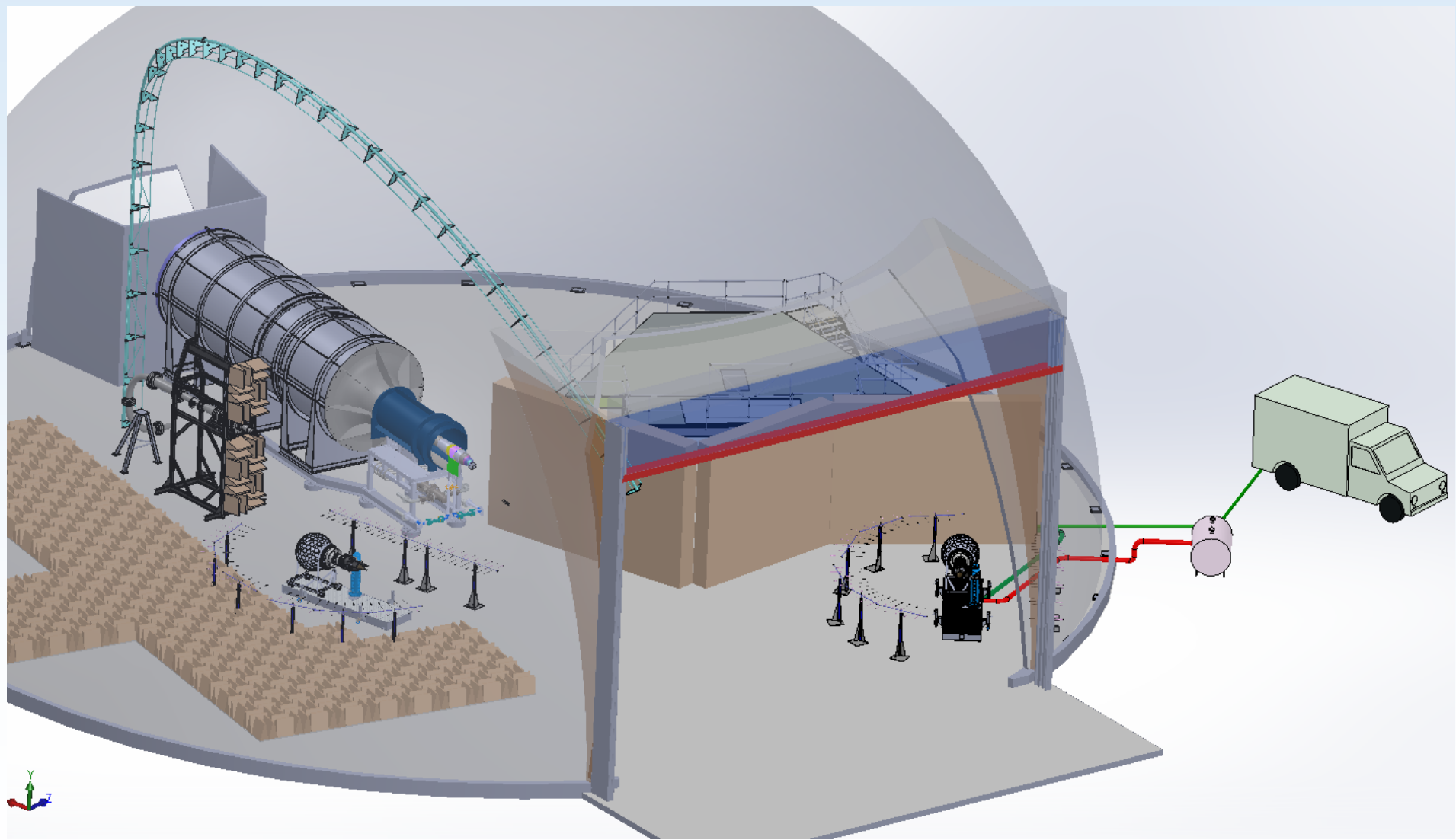



# Farfield Acoustic Directivity Evaluation - Background

## Desire to install DART in 9x15 / 14x22 Wind Tunnel

- Pylon would be on traverse side (acoustic measurement)
- Sideline vs Circular Array (azimuthal angle)

**GOAL:** Show acquiring data on pylon side is acoustically acceptable

## Define & Determine Farfield (ideally PBS outdoor arena to “complete”)

- Acoustic farfield (based on wavelength – complex projection)
- Geometric farfield based on engine length (simple projection)

## Overhead/Close-In Array comparisons and projection methodology

- OA little more into the geometric farfield but azimuthal angle variations!
- CA provides more diagnostic/research information (inlet/exhaust separation)
  - less attenuation (R,T,H, etc) & space/availability
- Geometric farfield arrays – point source EPNL calculation (not research)

**GOAL:** utilize CA advantages but develop methodology for projecting to farfield or determining when acquiring data in geometric farfield is required



# Configurations Tested August-2017

## PART II (arrays)

DATE	DGEN Config	Location	ARRAY	OTHER	THRUST
28-Apr-17	Baseline Inlet	ANCF	10ft arc - LHS	---	ON
4-Aug-17	Baseline Inlet	Near Center	10ft arc - LHS	Overhead Array	ON
7-Aug-17	Baseline Inlet	Near Center	10ft arc - LHS	Overhead Array	Locked Out
8-Aug-17	Baseline Inlet	Near Center	10ft arc - RHS	Overhead Array	Locked Out
10-Aug-17	Baseline Inlet	Near Center	Linear Array- RHS	Overhead Array	Locked Out
11-Aug-17	Baseline Inlet	Near Center	Linear Array- LHS	Overhead Array	Locked Out

STND FADEC Sweep:  
30 sec

Point	RPMc(%)
1	idle
2	50.0%
3	60.0%
4	70.0%
5	80.0%
6	90.0%
7	92.5%
8	95.6%*
9	50.0%
10	95.6%*
11	idle

DATA Acquisition:  
200 kHz @ 15 sec  
BW Filter 50Hz – 50kHz

\*safety restrictions limit max  
achievable speed with temp  
Lesson learned!





## II) Baseline Data

- a) Spectral Content
- b) Repeatability



# Forward Mic Array Spectral Summation @ 92.5% RPMc-Fan

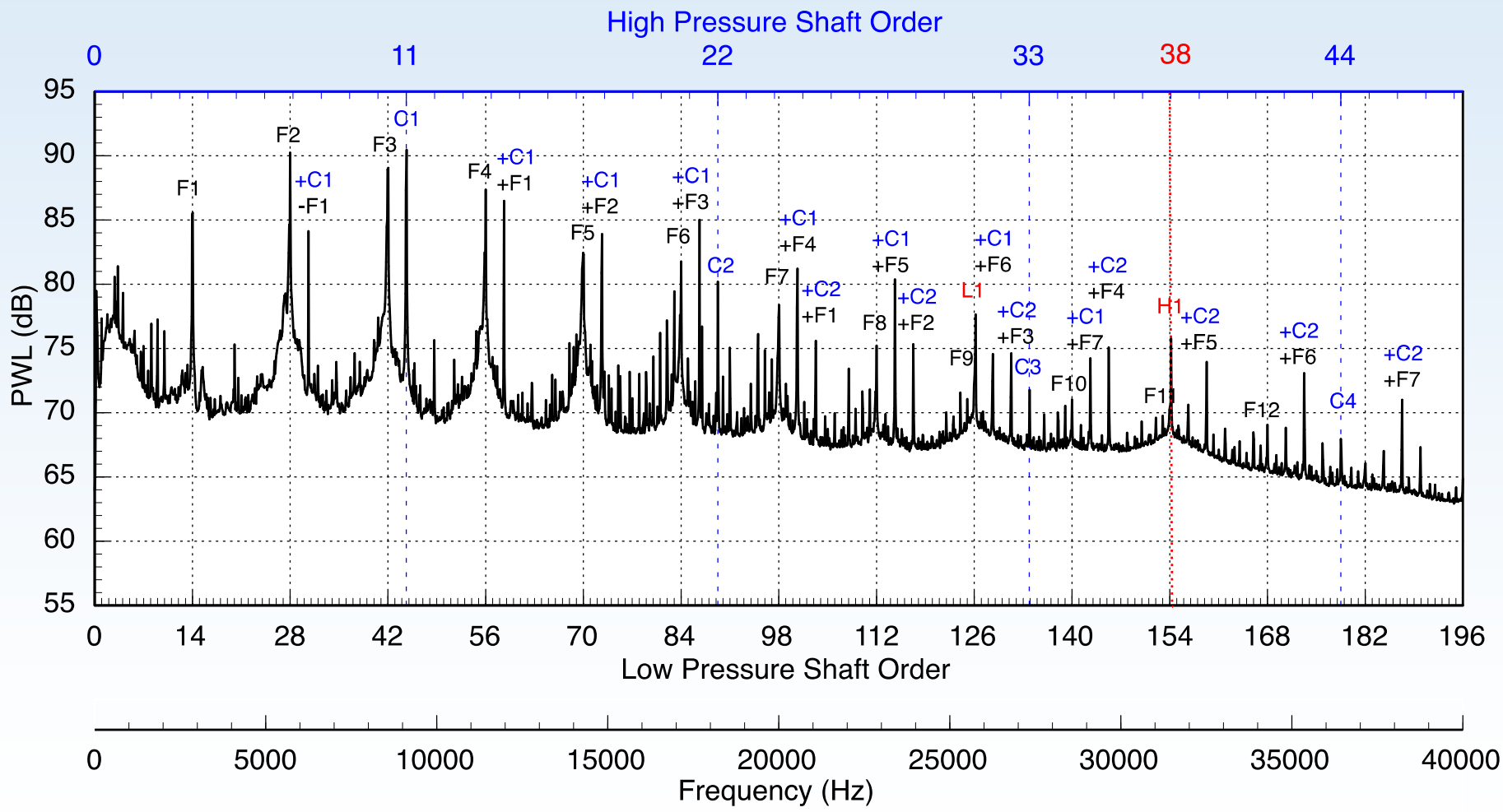



# Aft Mic Array Spectral Summation @ 92.5% RPMc-Fan

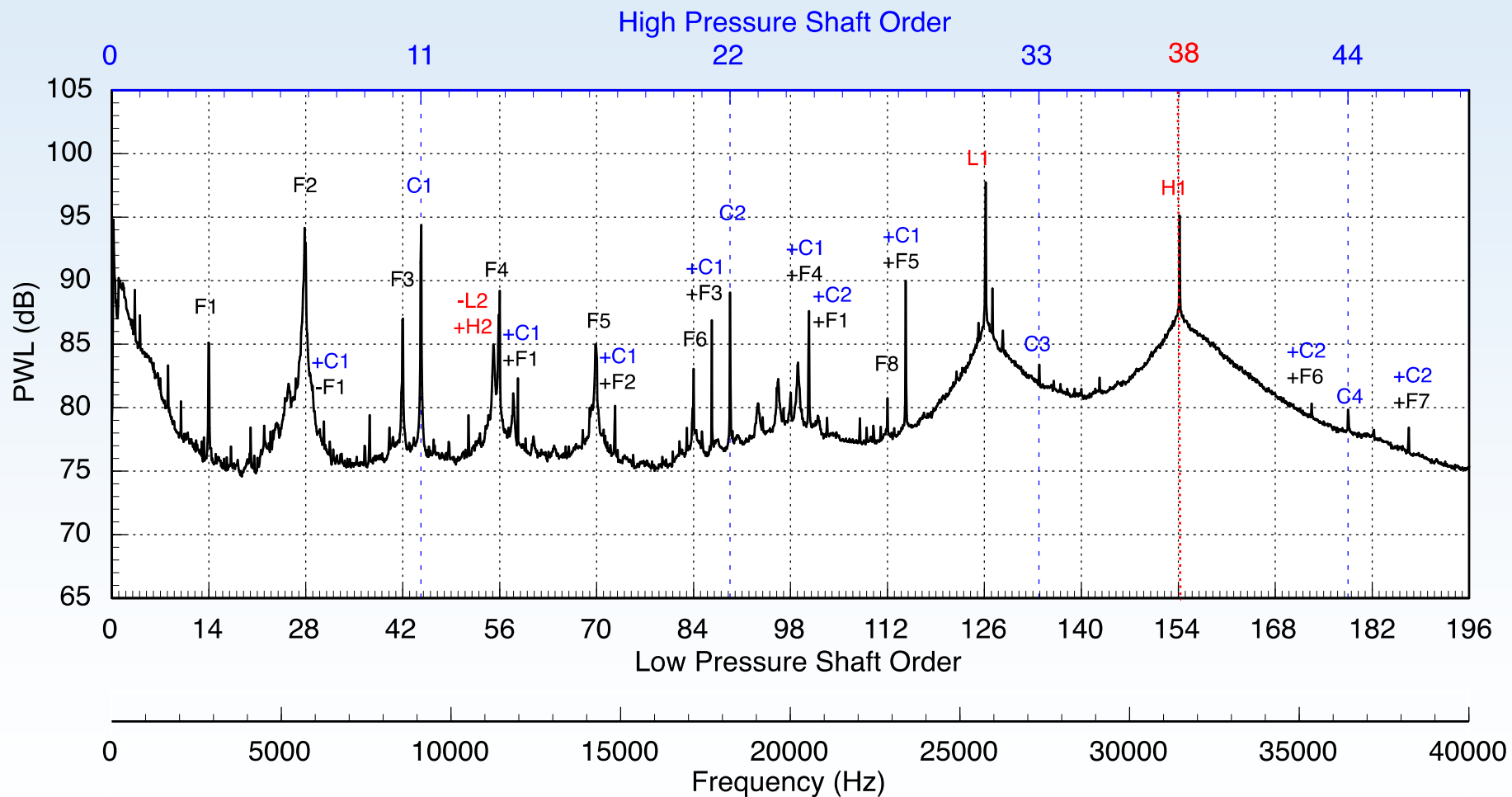



# 92.5% Fan-RPMc

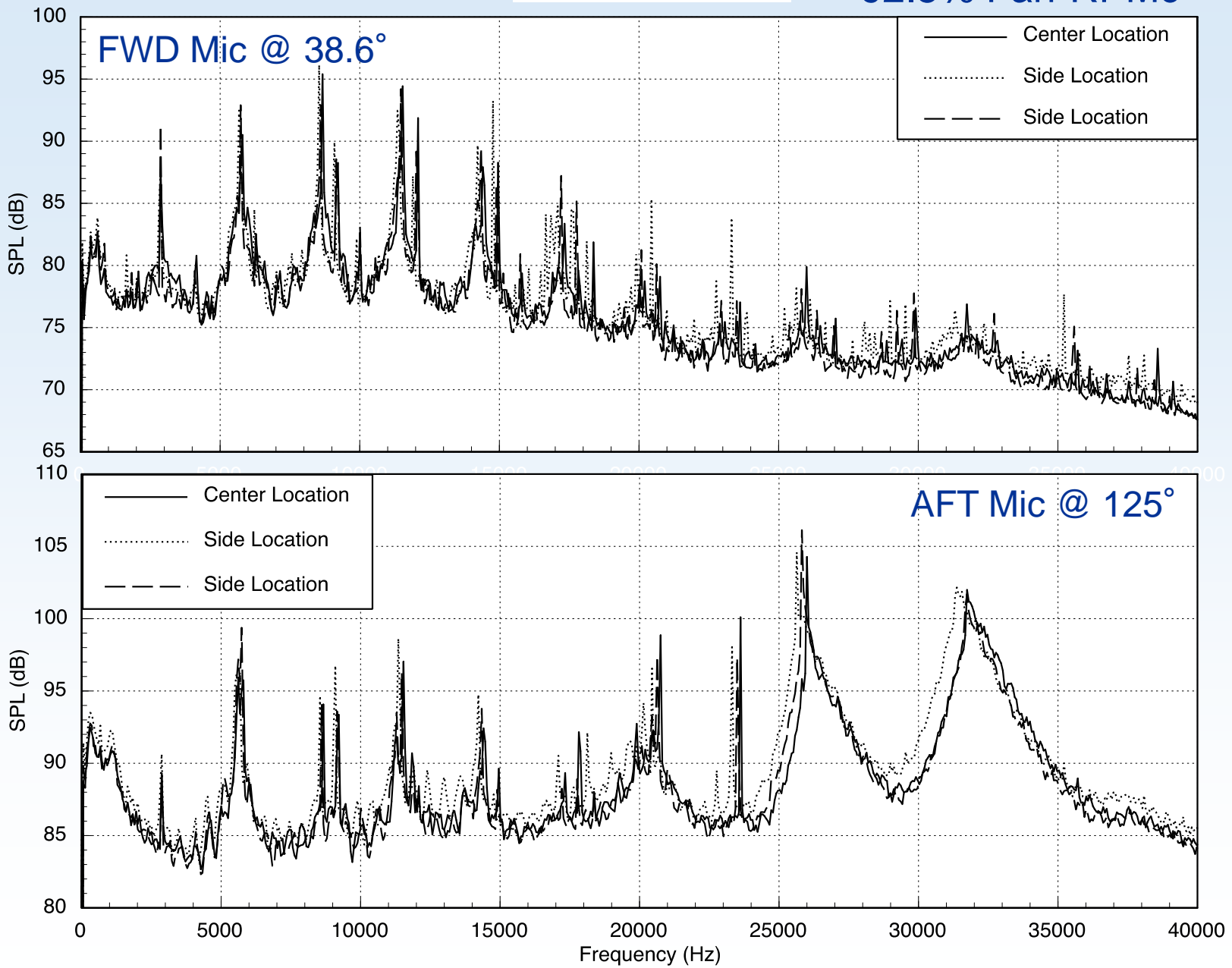
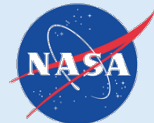

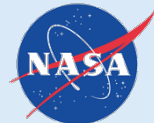

# 10-ft Arc Array Dimensions

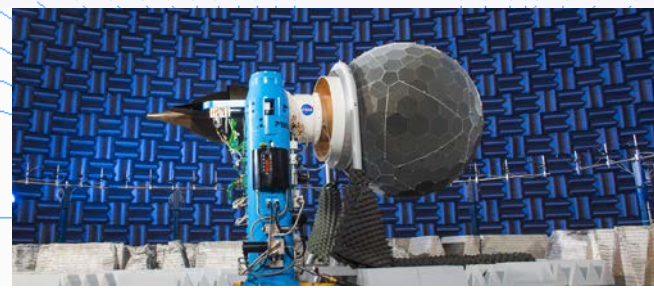
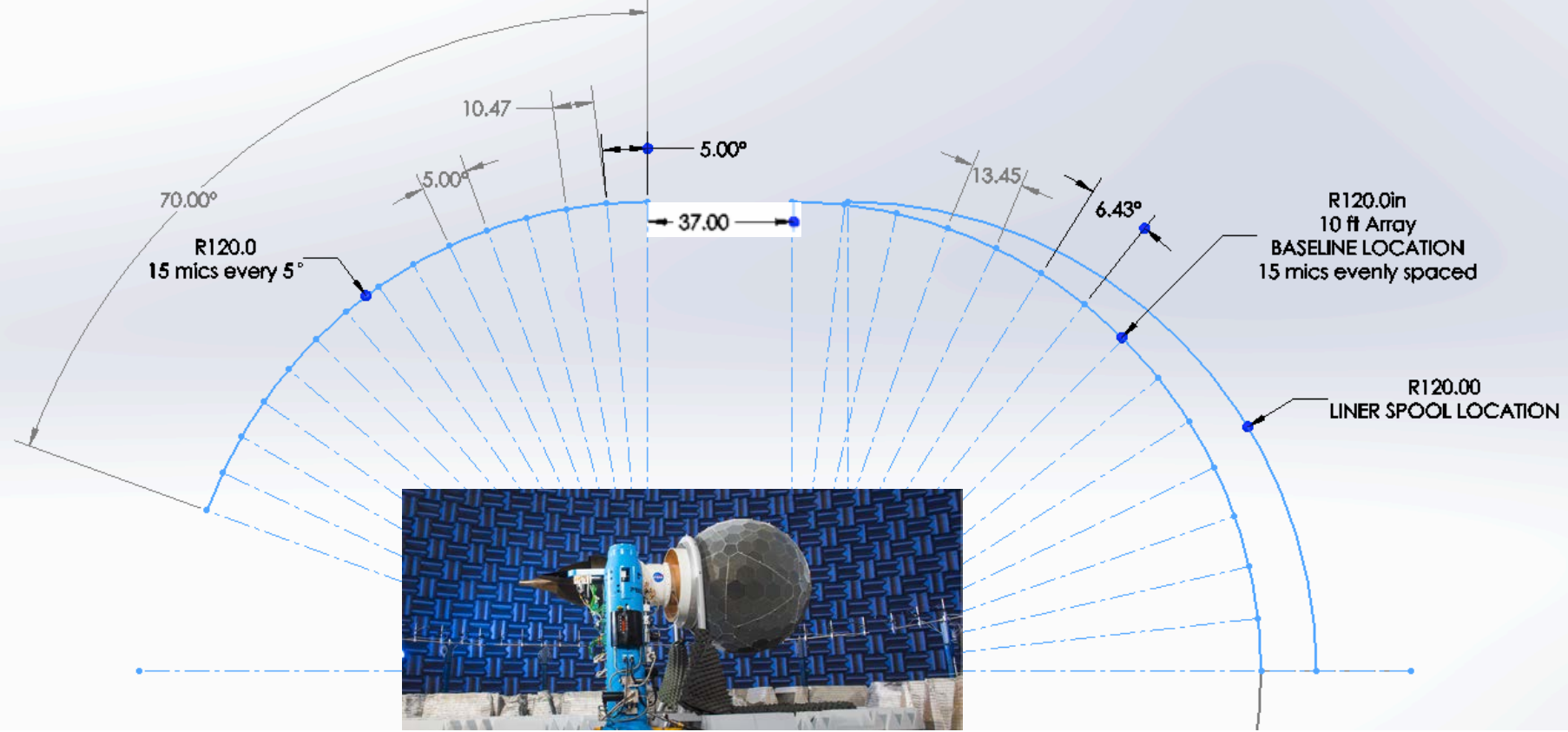
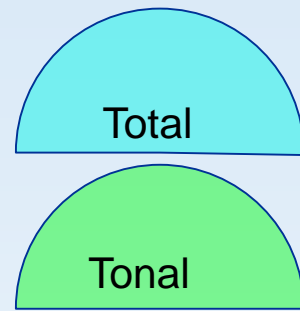
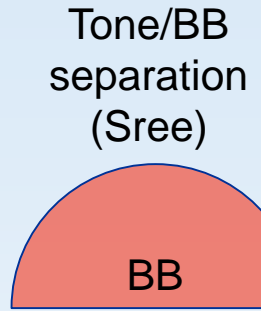
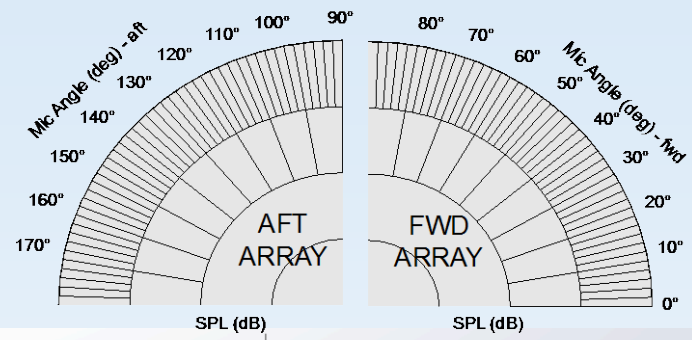



# Baselines Comparison

92.5% RPMc OASPL : 100 Hz to 40kHz

- L1 – ANCF location
- L2 – Near Center
- STD – standard inlet length
- EXT – Extended inlet length
- ON – Pylon free
- OFF – Pylon locked

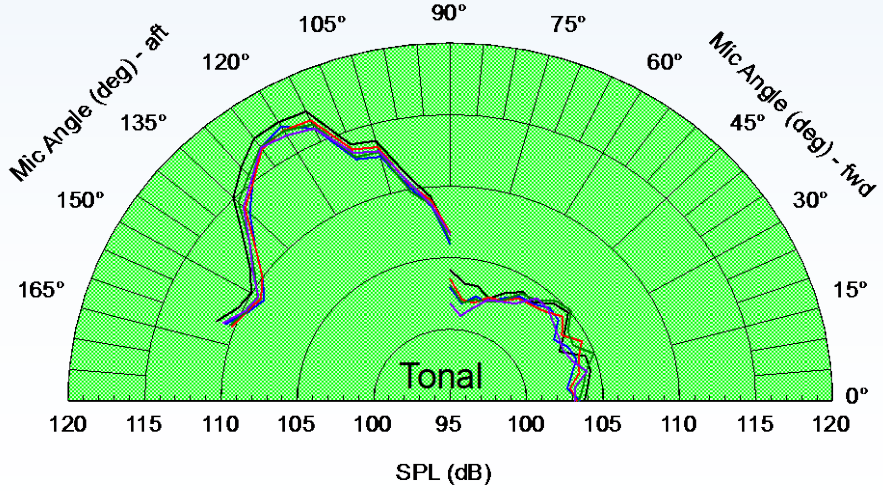
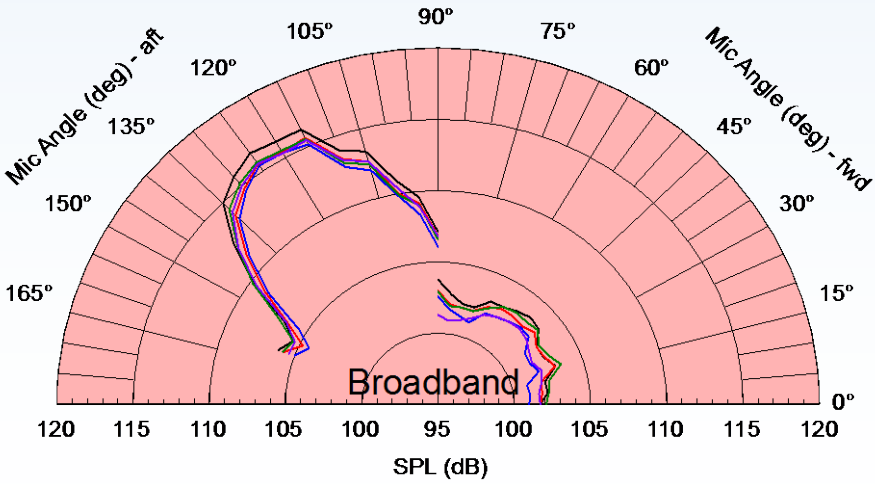
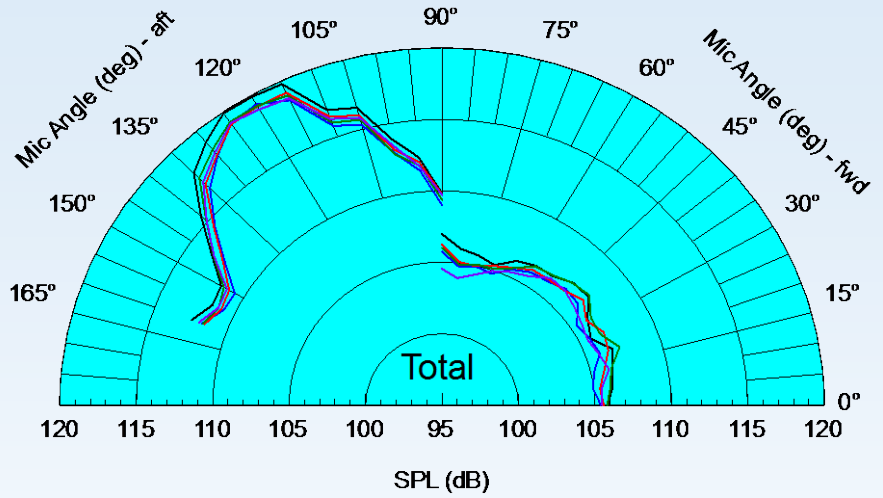
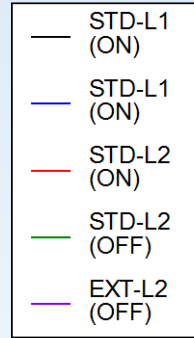

# Baselines Comparison

92.5% RPMc OASPL : 1 kHz to 10 kHz

L1 – ANCF location

L2 – Near Center

STD – standard inlet length

EXT – Extended inlet length

ON – Pylon free

OFF – Pylon locked

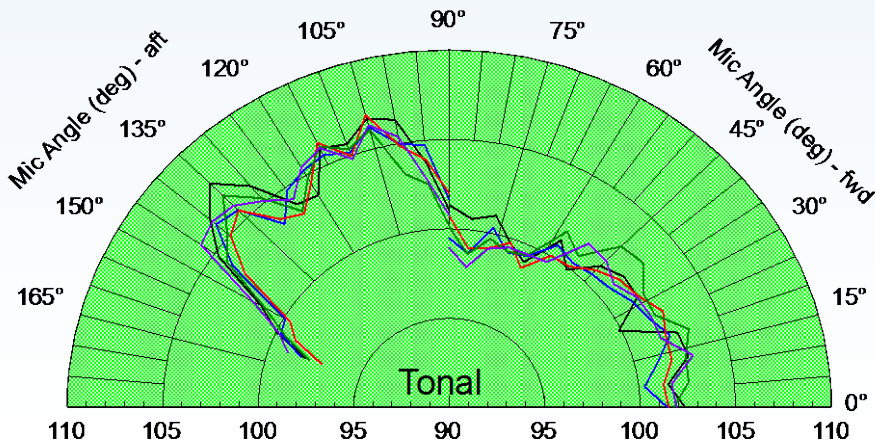
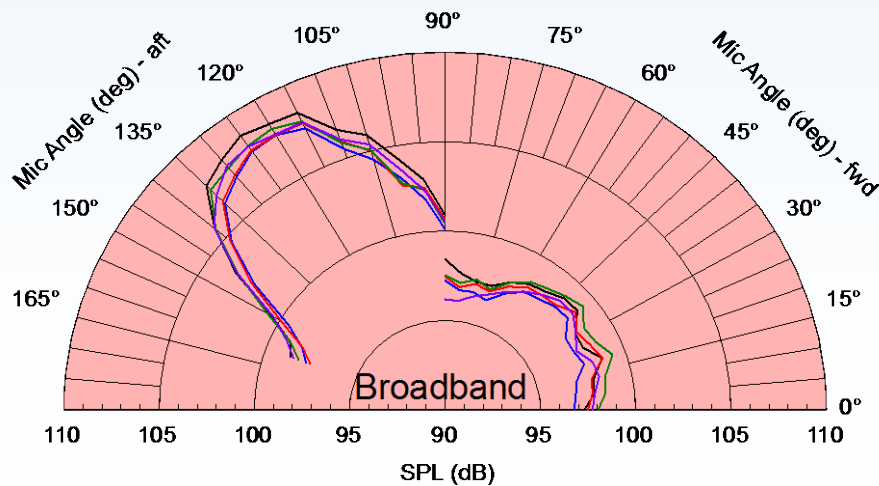
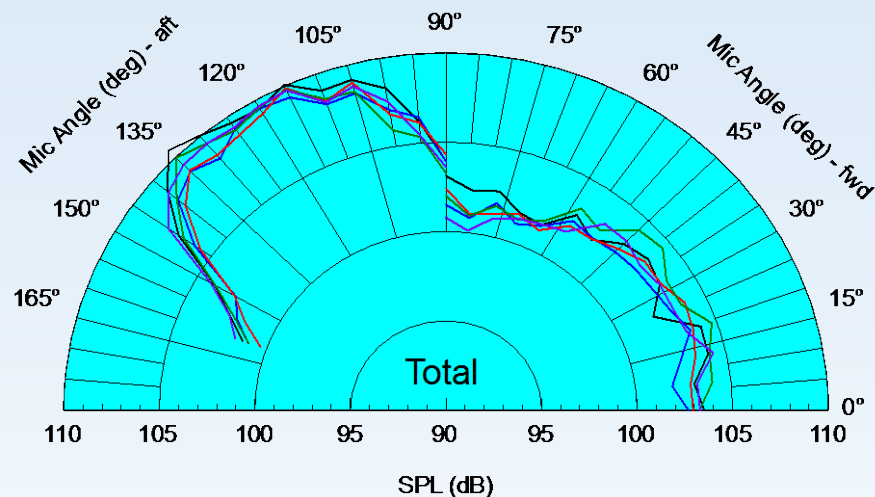
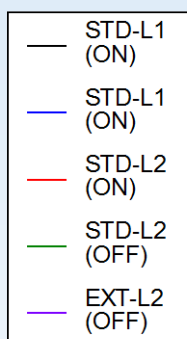

# Baselines Summary Comparison

92.5% RPMc

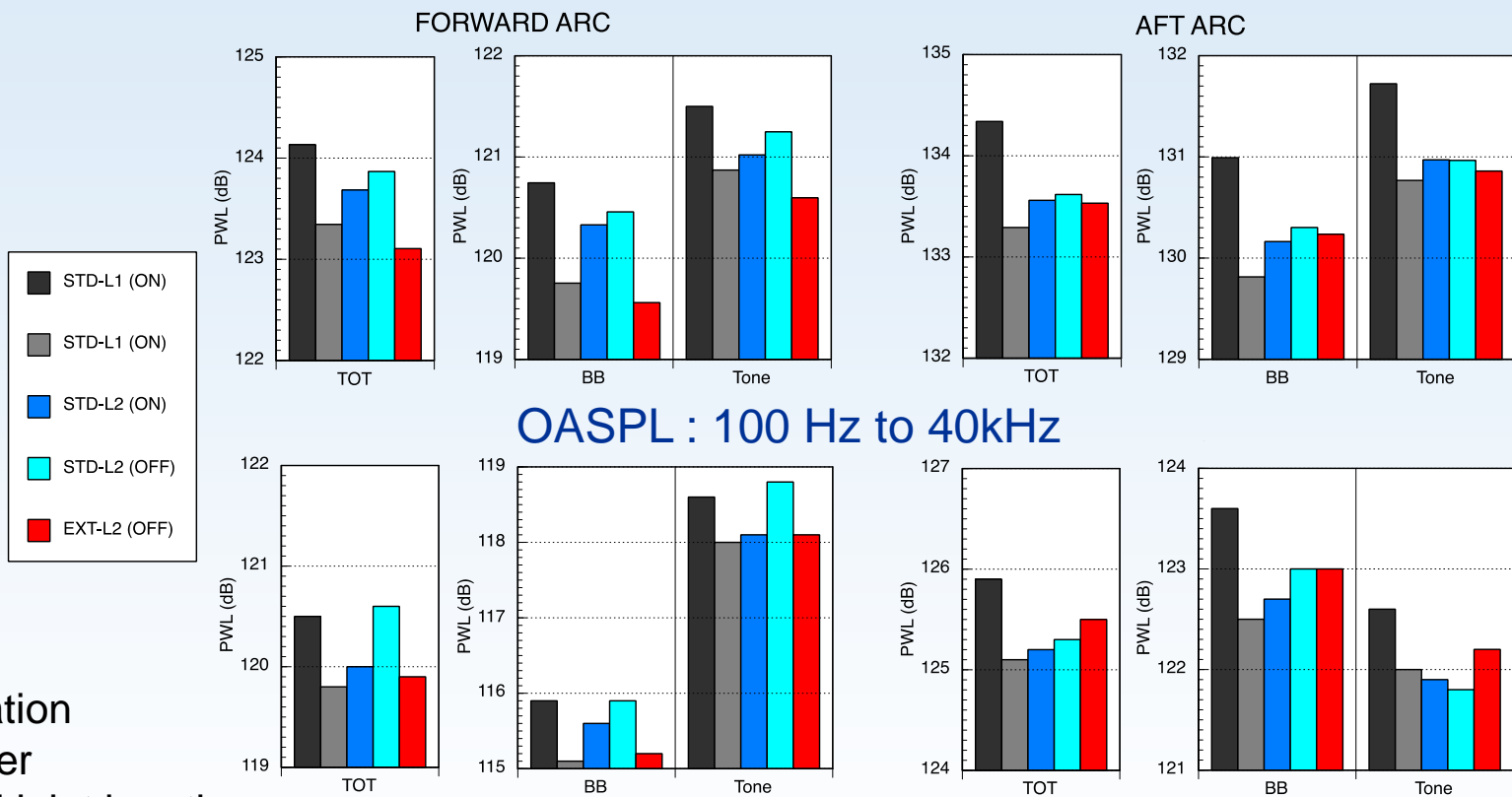

L1 – ANCF location  
 L2 – Near Center  
 STD – standard inlet length  
 EXT – Extended inlet length  
 ON – Pylon free  
 OFF – Pylon locked

OASPL : 100 Hz to 40kHz

OASPL : 1 kHz to 10 kHz

NO CORRECTIONS APPLIED!





# Fundamental and Harmonic Tones Directivity Isolation

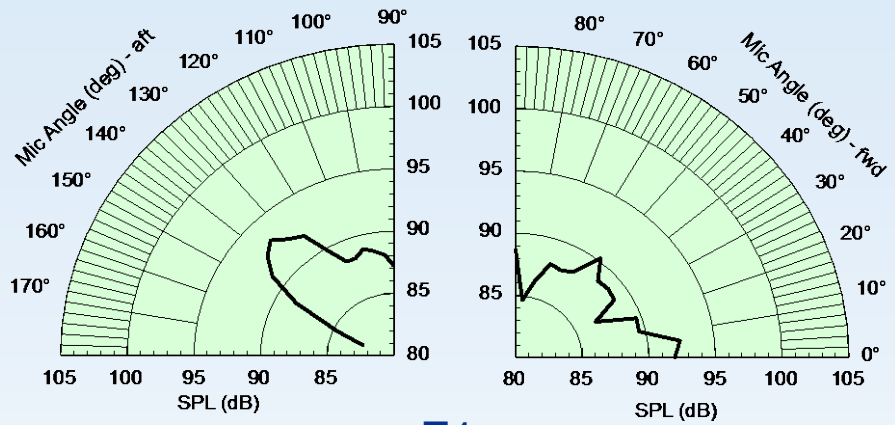

F1

C1

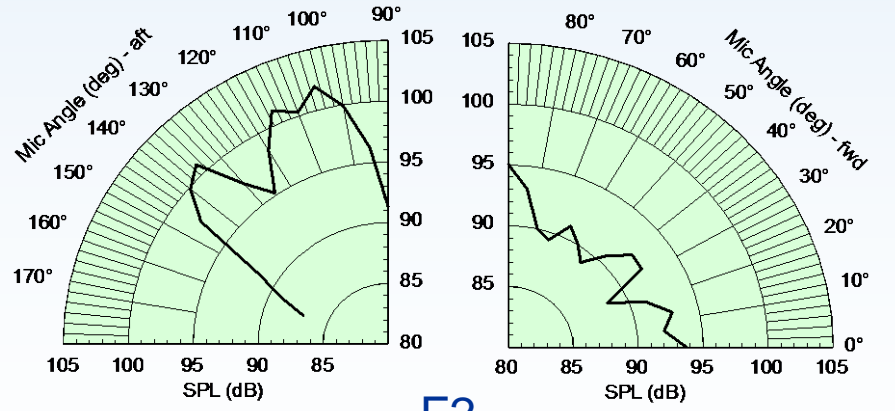

F2

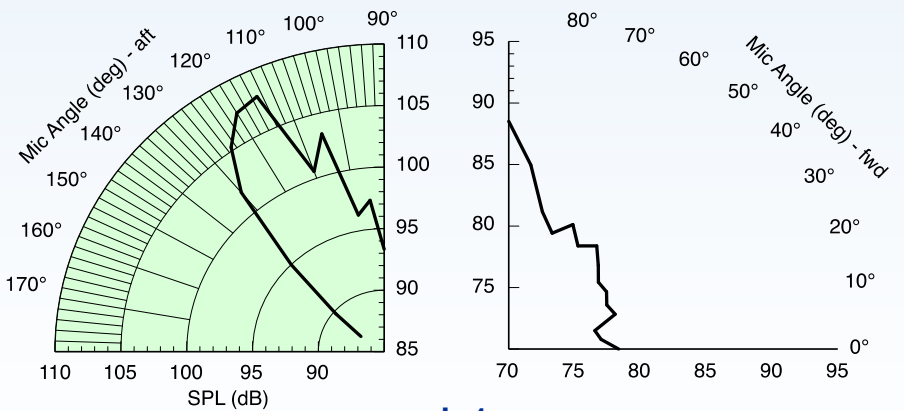

L1

(F1,F2,F3,F4,C1,C2,L1,H1)

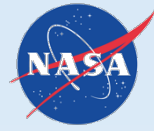

# Interaction Tones Directivity Isolation

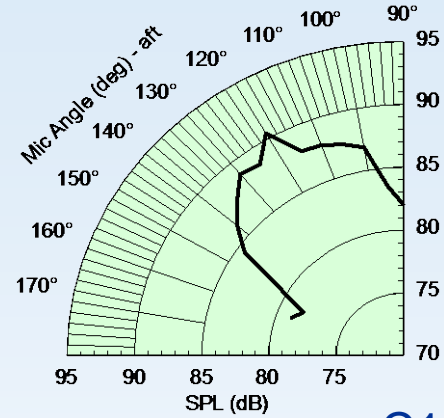

C1-F1

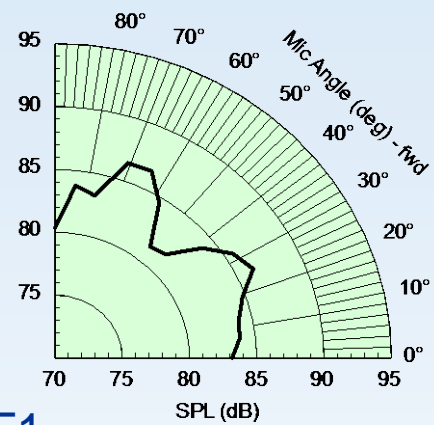

C1-F2

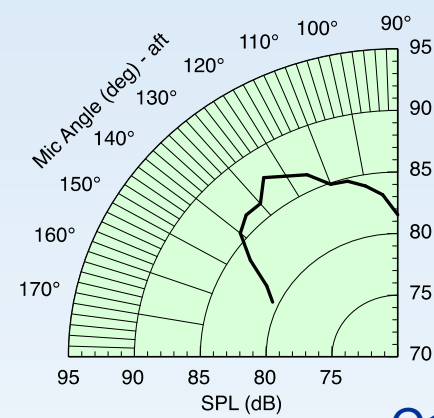

C1+F1

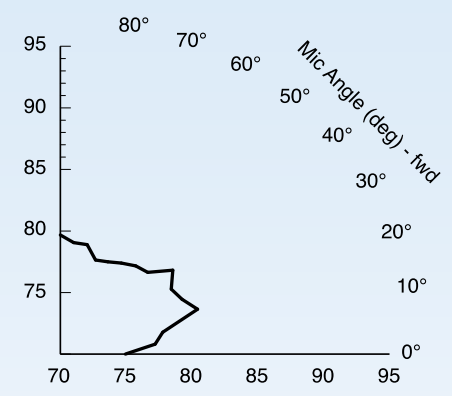

C1+F2

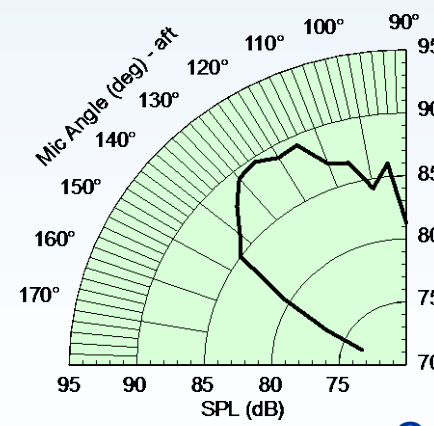
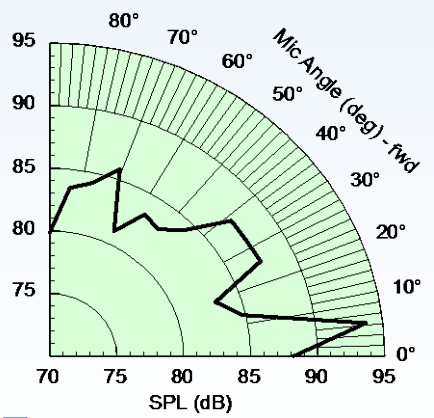

(C1+/- F1, C1+/- F2, C2+/- F1)



# III) Symmetry

- a) Circular Array
- b) Linear Array



# 10-ft Arc Array Dimensions

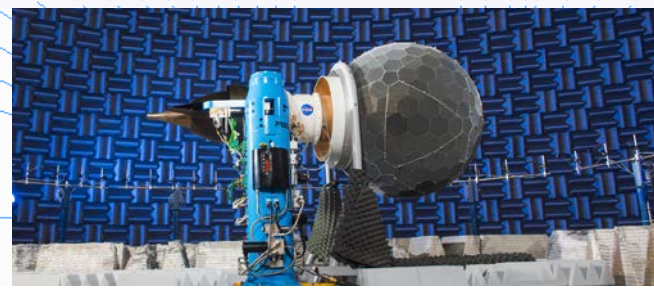
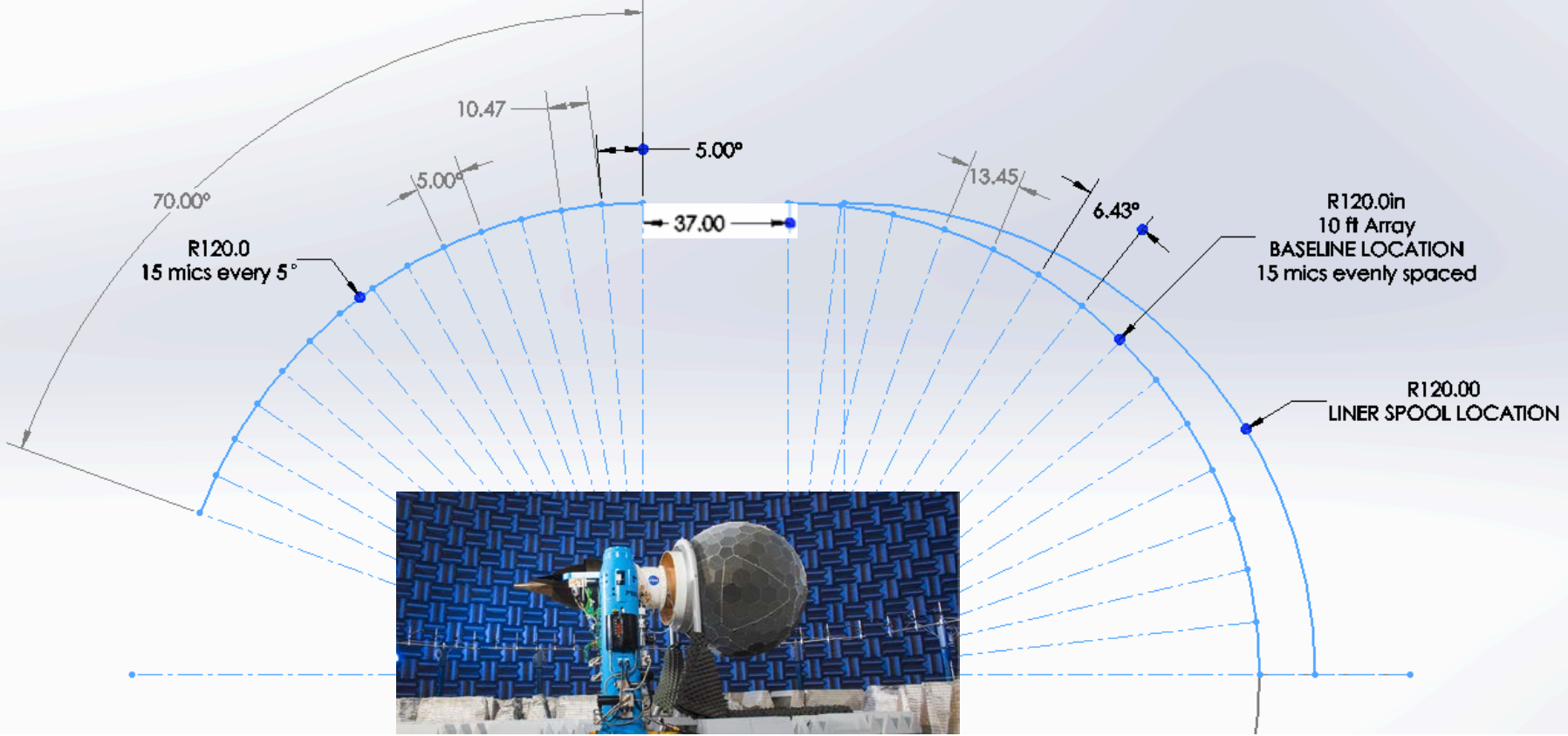
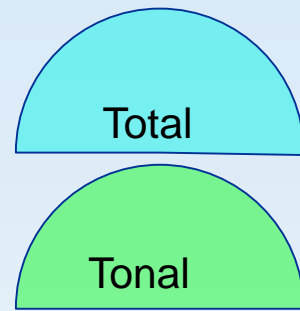
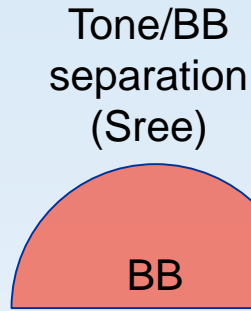
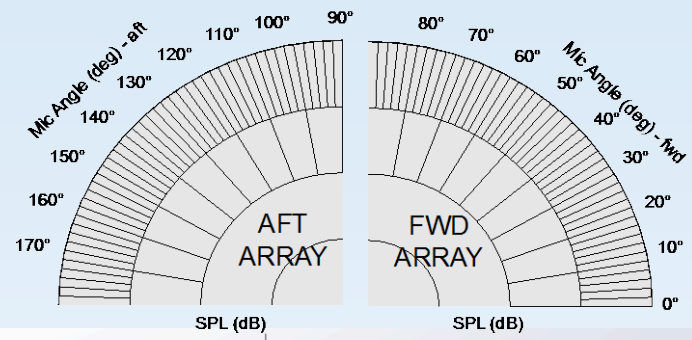

# Symmetry Comparison

Left Hand Side (LHS)

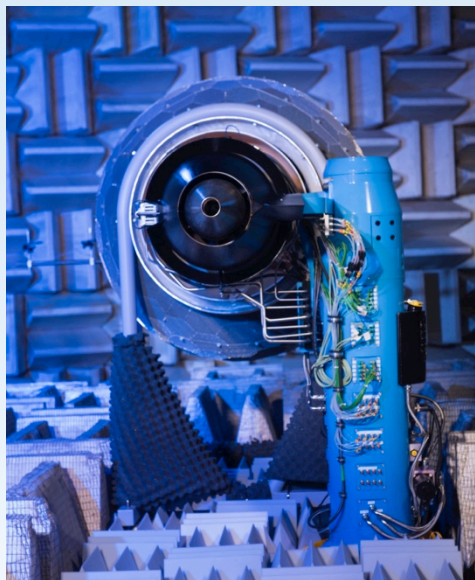

Right Hand Side (RHS)

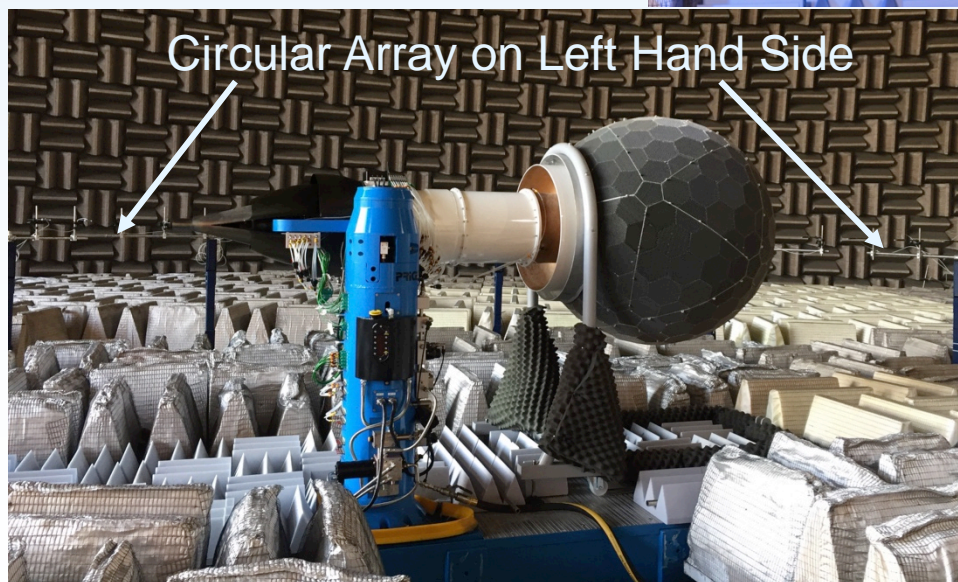

# Symmetry Comparison

LHS

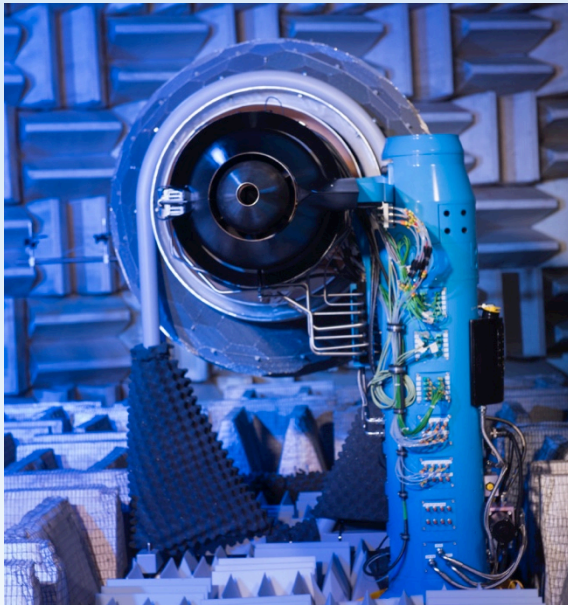

RHS

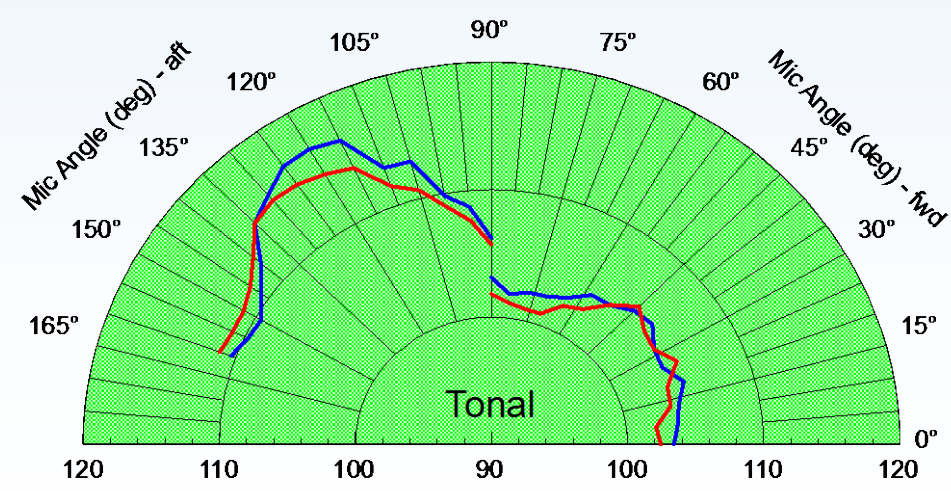
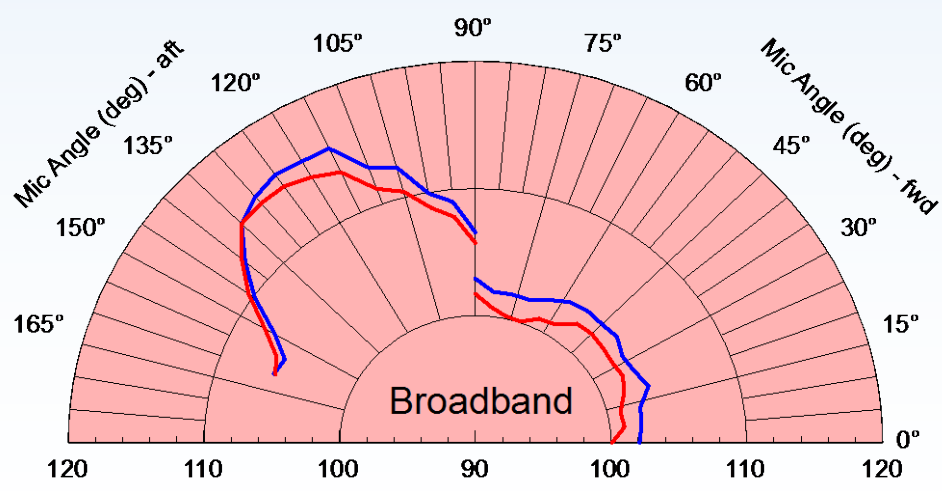
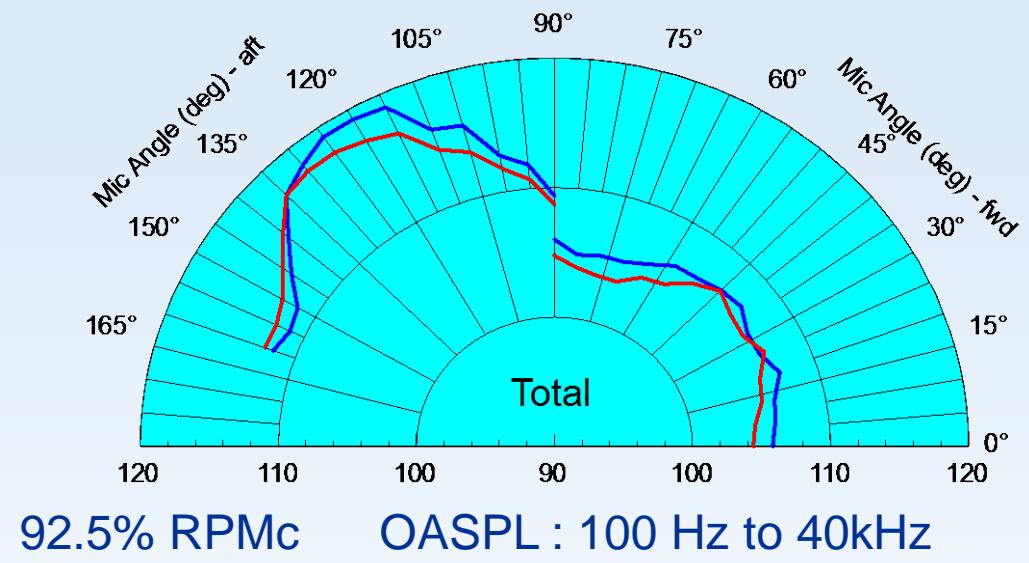

NO CORRECTIONS APPLIED!

(88" traverse in 9x15 WT)

# Linear Array

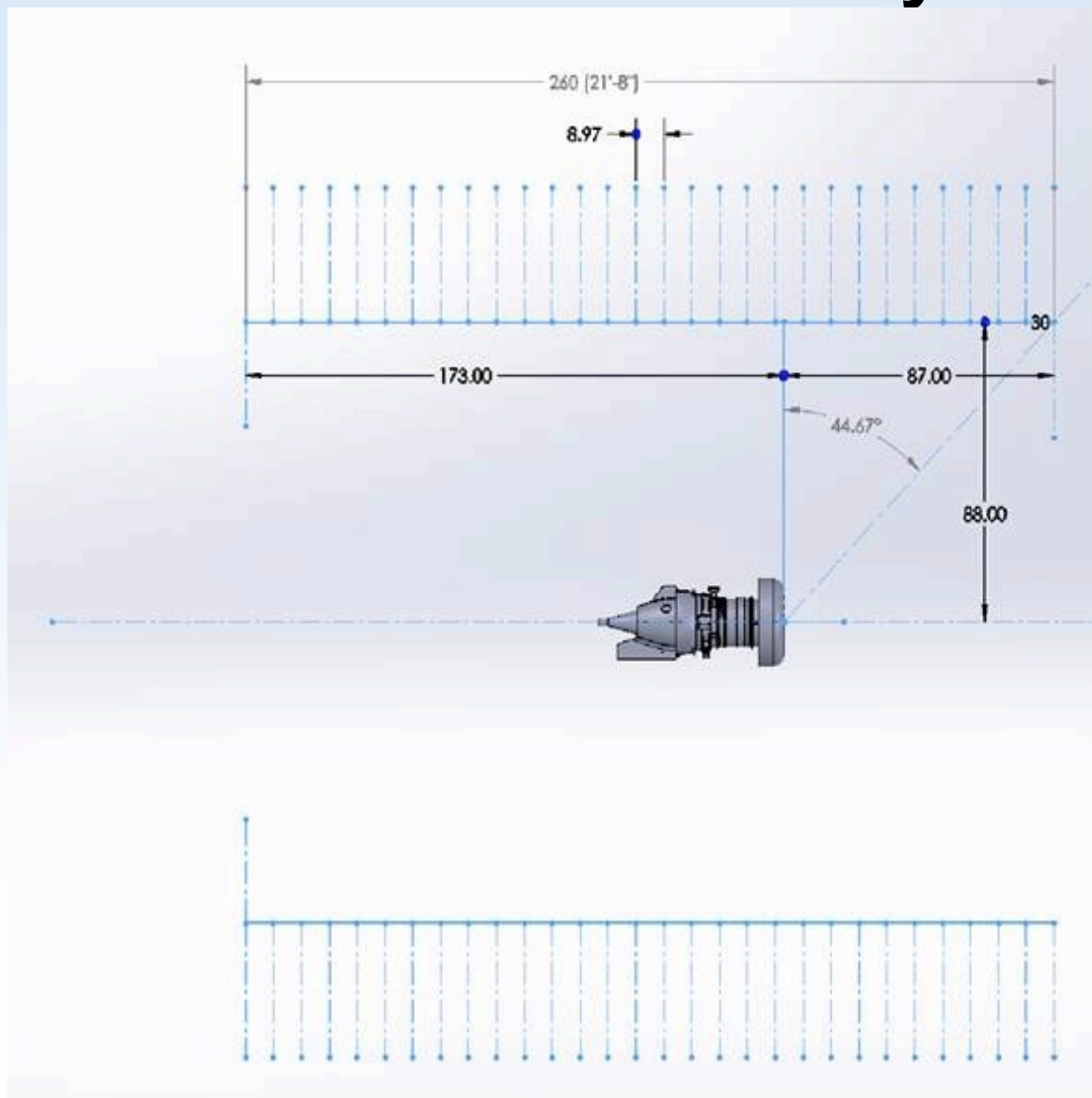

Mic	Inches
1	0
2	8.97
3	17.94
4	26.91
5	35.88
6	44.85
7	53.82
8	62.79
9	71.76
10	80.73
11	89.7
12	98.67
13	107.64
14	116.61
15	125.58
16	134.55
17	143.52
18	152.49
19	161.46
20	170.43
21	179.4
22	188.37
23	197.34
24	206.31
25	215.28
26	224.25
27	233.22
28	242.19
29	251.16
30	260.13

# Symmetry Comparison

92.5% RPMc

OASPL :  
100 Hz to 40kHz

LHS



RHS

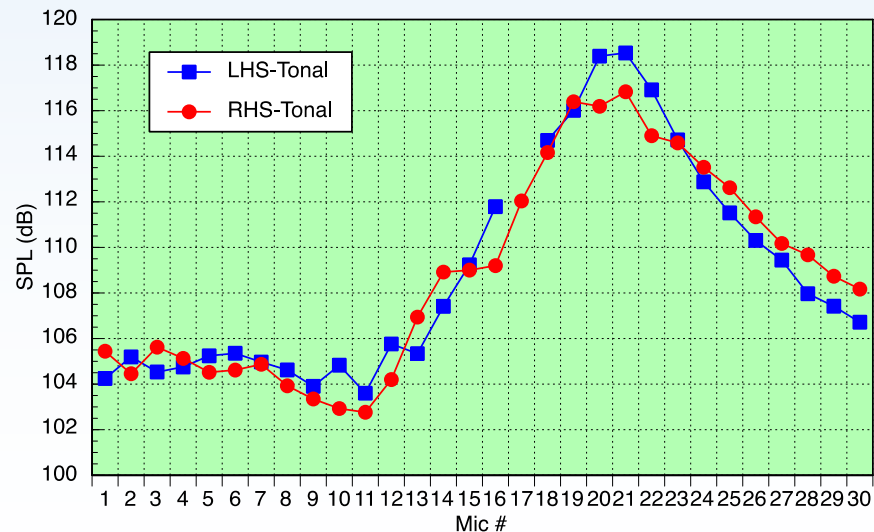
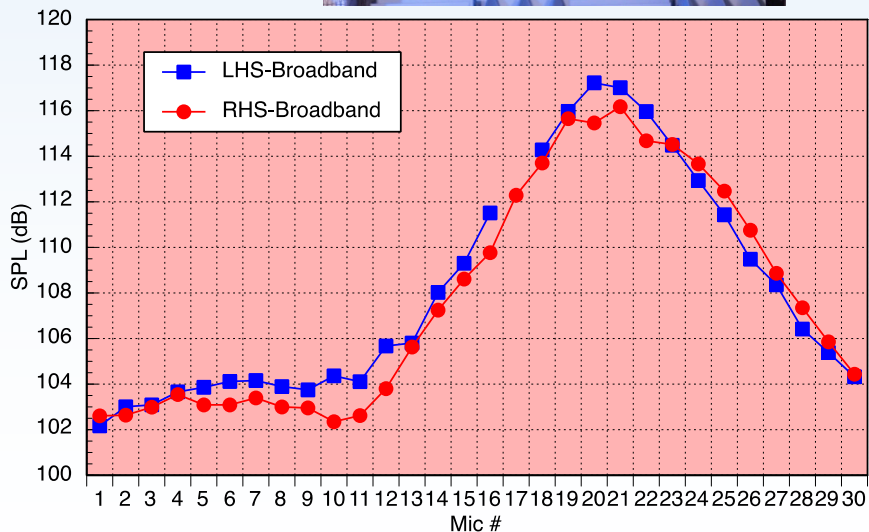
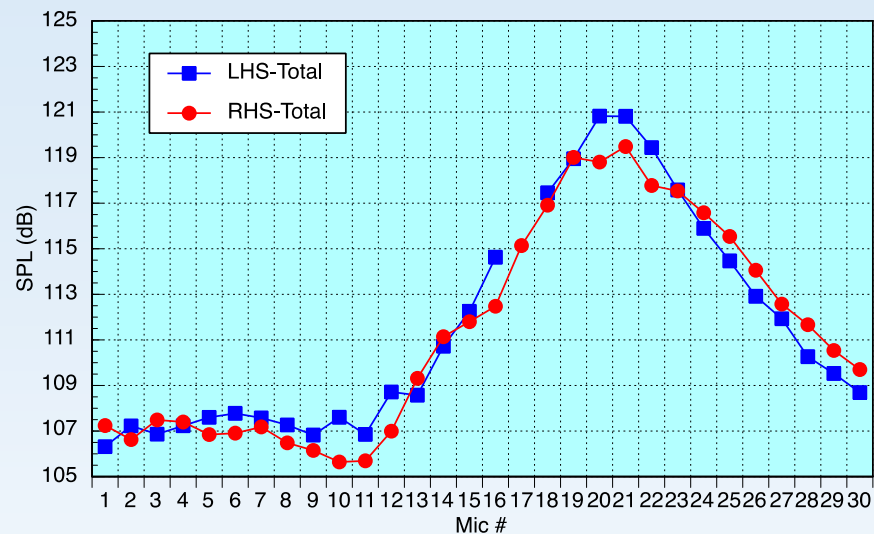

**NO CORRECTIONS APPLIED! (Including R)**





# IV) Conclusion



# Acoustic Directivity of the DGEN Aero-propulsion Research Turbofan at Multiple Farfield Array Locations

## Acoustic Data Acquired from DART

- Repeatability is typical
- Symmetry is acceptable

Companion Paper Comparisons to Overhead Array @  
Location #2 – projection to a common distance.

Part of an Proposed Effort to Compare & Define Geometric/  
Acoustic Farfield

- Wind Tunnel?
- Outdoor Facility?

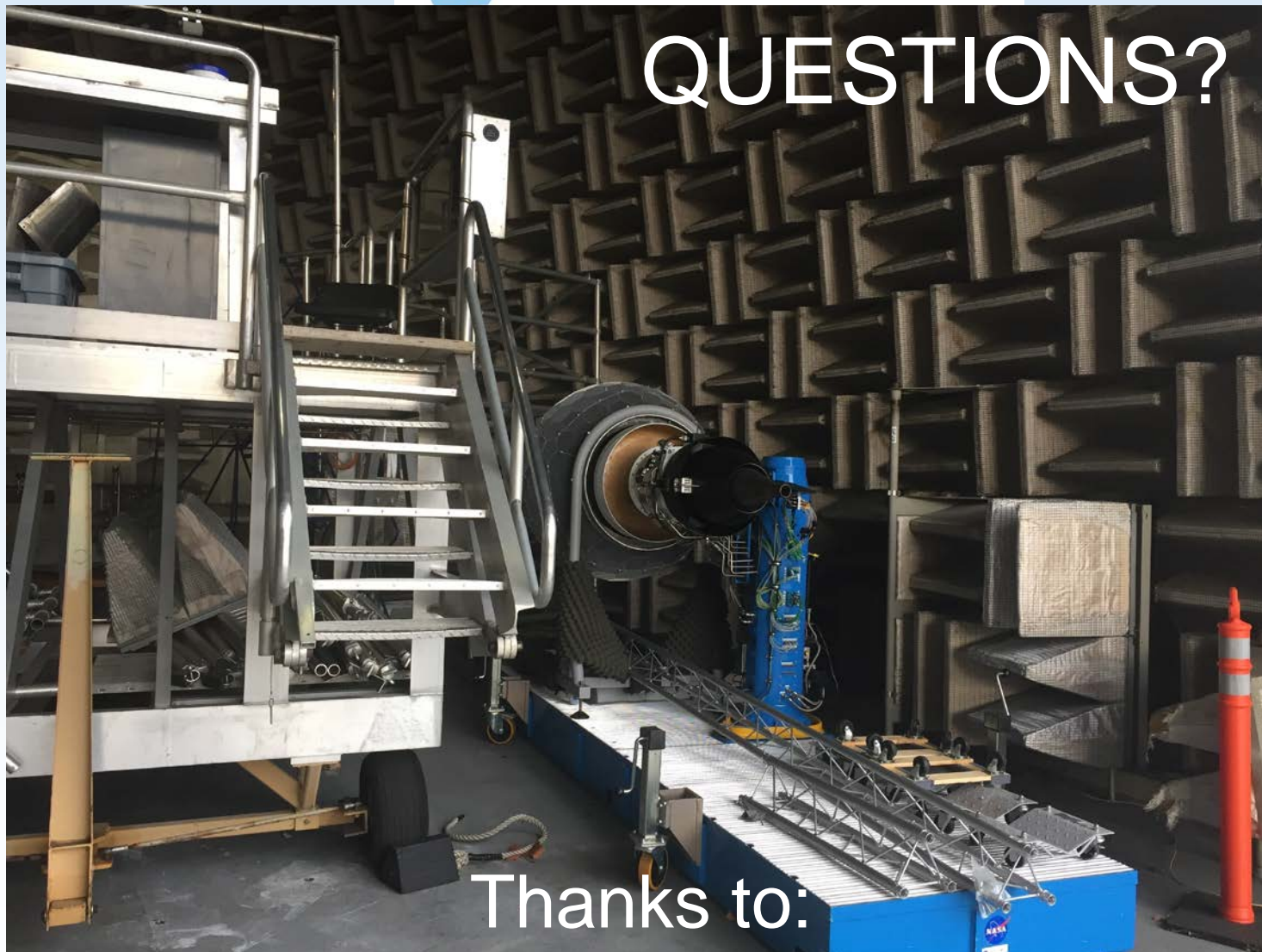

Thanks to:

**Price Induction, SA & TFOME Staff @ AAPL**