



Diagnostic for Verifying the Thrust Vector Requirement of the AEPS Hall-Effect Thruster and Comparison to the NEXT-C Thrust Vector Diagnostic

Gabriel F. Benavides, Jonathan A. Mackey, Robert E. Thomas,
and Drew M. Ahern

NASA Glenn Research Center, Cleveland, OH, USA 44135

54th AIAA/SAE/ASEE Joint Propulsion Conference
9 July 2018, Cincinnati, Ohio

Diagnostic for Verifying the Thrust Vector Requirement of the AEPS Hall-Effect Thruster and Comparison to the NEXT-C Thrust Vector Diagnostic

1. Motivation for Diagnostic Development
2. Diagnostic Design Objectives
3. Prior Thrust Vector Diagnostics
4. Pre-Design Analysis
5. Design
6. Initial Diagnostic Measurements
7. Summary

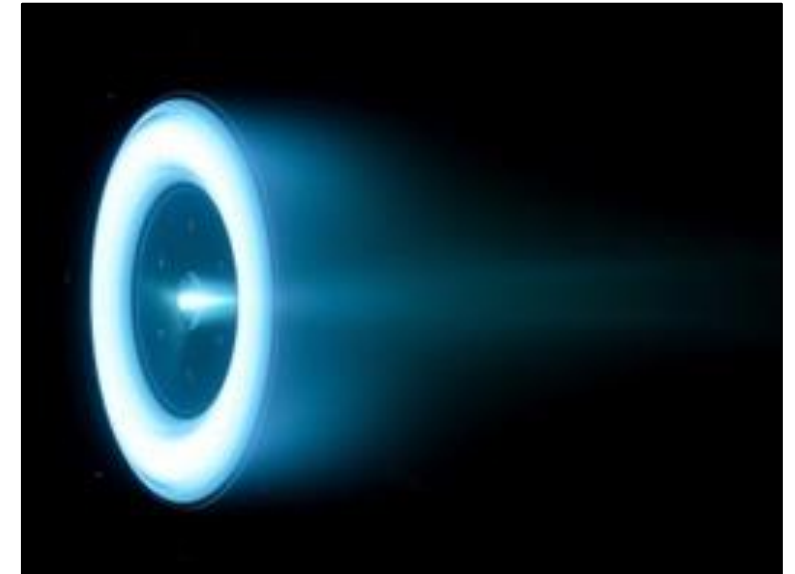

Hall Effect Rocket with Magnetic Shielding (HERMeS) Technology Development Unit (TDU)

Motivation for Diagnostic Development

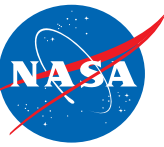

12.5-kW Advanced Electric Propulsion System:

- The Advanced Electric Propulsion System (AEPS) contract will develop and qualify the 12.5-kW Hall thruster system for the Power and Propulsion Element (PPE) of NASA's Gateway.

Need for thrust vector characterization:

- Assess the Engineering Development Unit (EDU) thrust vector behavior over the 23khr duration test.
 - BOL, EOL, transients, drift, etc.
- Verify the EDU behavior satisfies all AEPS thruster specification requirements related to the thrust vector.
- Assess the thrust vector by a minimally intrusive method such that no requirements related to test facility or conditions are violated.

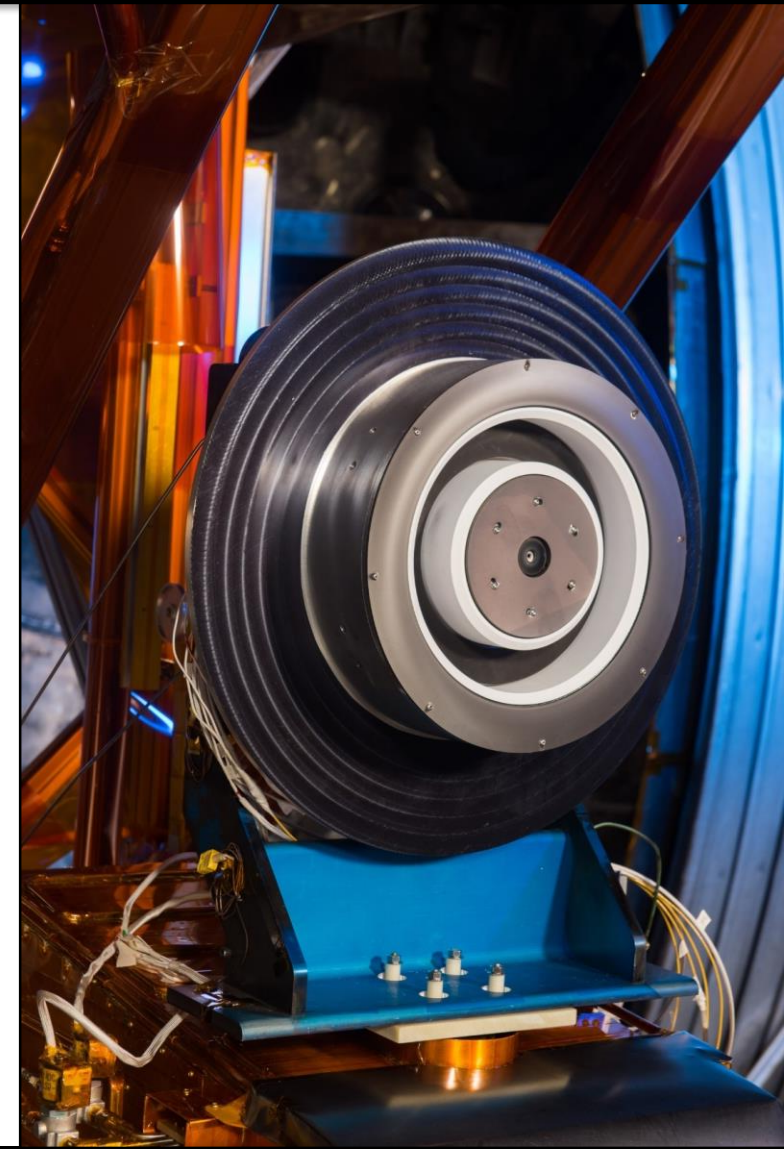

AEPS Requirements and Design Objectives

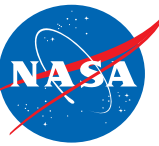

I. AEPS contract requirements:

- I. The thrust vector offset from the mounting surface normal vector shall not exceed 1.5° over the entire throttling range and over the lifetime of the thruster.
- II. All thruster components shall maintain the required voltage standoff capability in the presence of a facility carbon backsputter rate of $2 \mu\text{m}/\text{hr}$ for 23 khrs.

II. Diagnostic design objectives:

- I. Must have sufficient accuracy and resolution to track a thrust vector deviation of $\leq 1.5^\circ$.
- II. The diagnostic must provide an absolute thrust vector measurement relative to the thruster's mounting surface normal vector.
- III. The diagnostic must survive the test facility environment for >23 khr of thruster operation.
- IV. The diagnostic needs to be capable of taking measurements as frequently as every 5 minutes.
- V. The diagnostic needs to be operable over the EDU thruster's entire throttling range.
- VI. Implementation of the diagnostic shall not increase the facility lifetime average backsputter rate above $2 \mu\text{m}/\text{hr}$.

Prior Thrust Vector Diagnostics

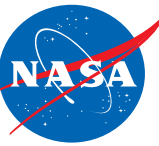

I. Diagnostic consisting of an array of graphite rods.

- Tracking current collected on the rods provides an estimate of thrust vector relative to the array.
- Successfully implemented for NSTAR and NEXT gridded ion thrusters by both JPL and NASA GRC.

II. Diagnostic consisting of mechanical thrust stand.

- Direct thrust vector measured by repeatedly orienting thruster relative to thrust stand in a well defined way.

III. Diagnostic consisting of an array of plasma probes swept through exhaust plume.

- Mapping ion densities/energies in the plume provides an estimate of thrust vector relative to the swept array.
- Successfully implemented for Langmuir probes, retarding potential analyzers, and Faraday probes.
- Compatible with existing probe hardware.

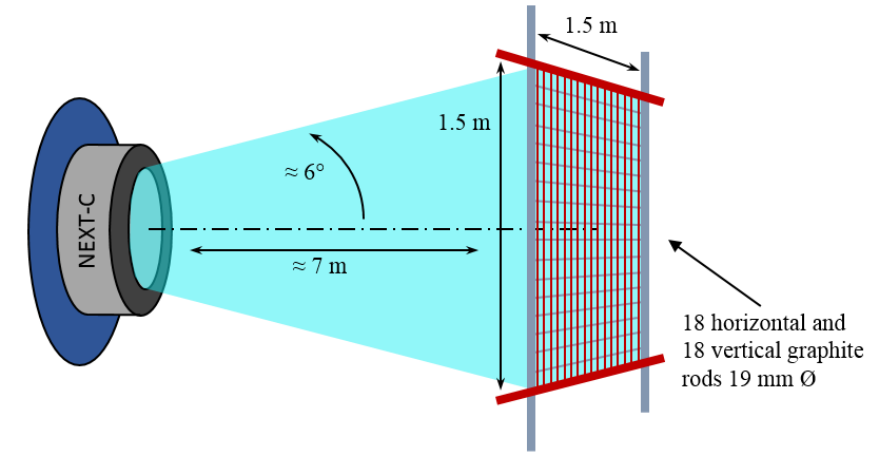

NEXT DEV-C Thruster in VF-16

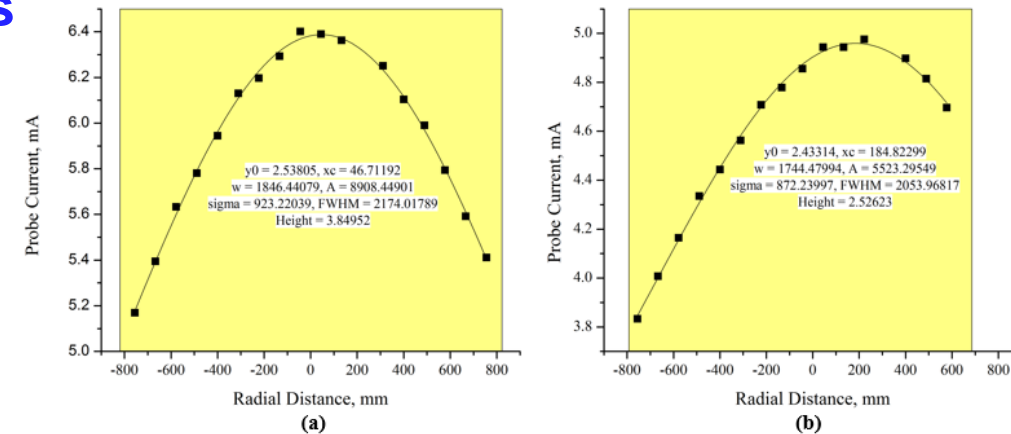

Thrust Vector Diagnostic Selection

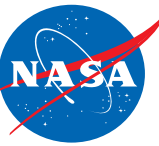

- I. Diagnostic consisting of an array of graphite rods.**
 - Array has potential to increase the facility carbon backscatter rate beyond AEPS requirement of $2 \mu\text{m}/\text{hr}$ for 23 hrs.
 - Placing array to satisfy the backscatter requirement only allows for $\pm 7^\circ$ collection angle.
- II. Diagnostic consisting of mechanical thrust stand.**
 - Not well suited for 23 hr long duration testing, requires re-orienting thruster on stand.
 - Not compatible with existing test hardware.
- III. Diagnostic consisting of an array of plasma probes swept through exhaust plume.**
 - Compatible with existing hardware, backscatter rate, testing duration, and can sweep large angles.
 - Retarding potential analyzers are difficult to calibrate and slow to collect data. Faraday probes are relatively simple and relatively faster.
 - Further investigate a swept Faraday probe based system.

Pre-Design Analysis

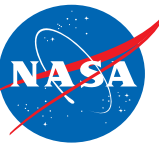

- I. Use existing Faraday probe data to help design thrust vector diagnostic system.
 - Collected Faraday probe (FP) data on AEPS Technology Development Unit 1 (TDU-1).
 - Collected data at a range of radial locations and angular sweeps.
 - Current density plots (right) show typical profiles representative of the TDU-1 Hall thruster.

- II. Profiles are characterized by a main peak with a recessed center region, giving the appearance of two overlapping peaks.
 - Recessed center is a result of the annular nature of the Hall thruster.
 - Raw data center has been calculated from numerical integration and curve fitting various profiles.
 - Most simple profiles but do not deal with center recession well, motivating an exclusion region or weighted fitting methods.

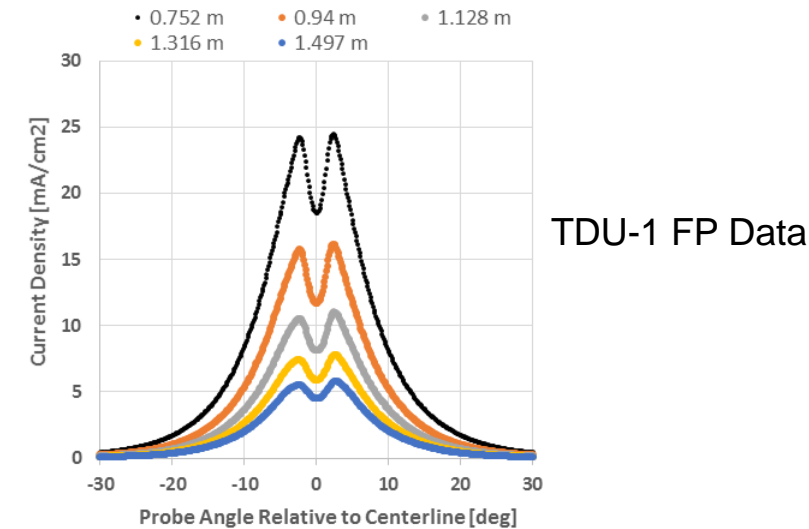

TDU-1 FP Data

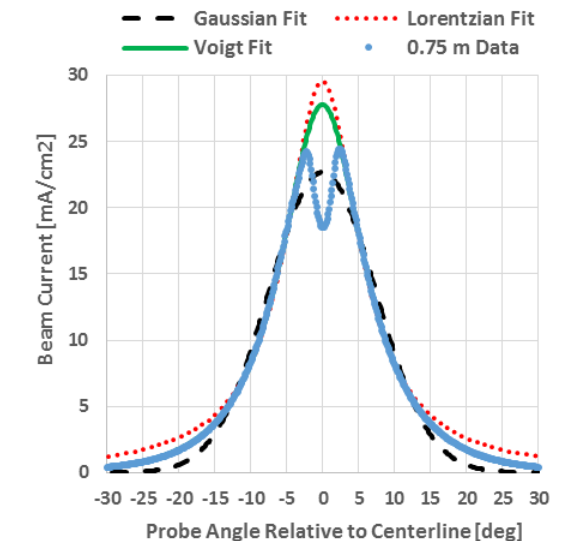

Curve Fitting
FP Data

Pre-Design Analysis (cont.)

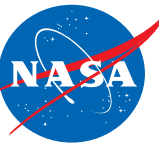

- Evaluated TDU-1 FP data subset with three variables of interest:
 - Collection range large and small:
 - Small $\pm 7^\circ$, possible with graphite rod diagnostic or swept probe arrays.
 - Large $\pm 15^\circ$, only possible with swept probe arrays.
 - Center $\pm 3^\circ$ recess handling condition:
 - Include in curve fit.
 - Exclude from curve fit.
 - Fitting profiles investigated:
 - Gaussian, Lorentzian, and Pseudo-Voigt (combination of Gaussian and Lorentzian).
- Data sets selected as asymmetric to emphasize fitting errors.

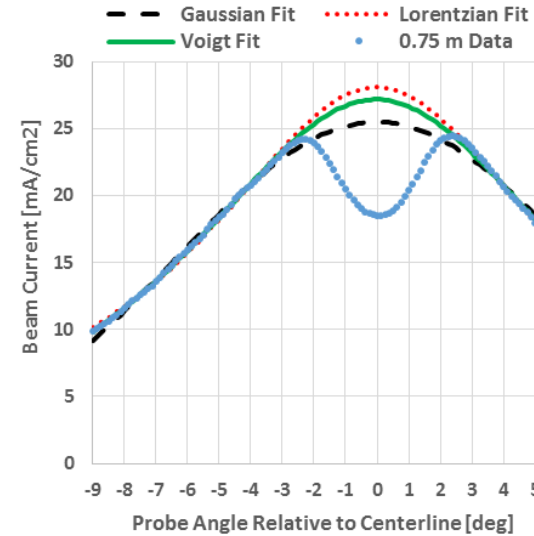

TDU-1 FP Data +5 to -9°

	Resulting Fitting Error [deg]		
+/- 3 deg	Gaussian	Lorentzian	P-Voigt
Including	0.436	0.523	0.436
Excluding	0.048	0.041	0.035

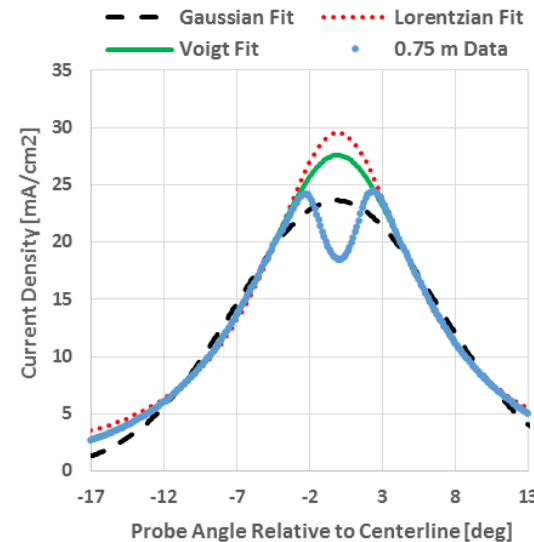

TDU-1 FP Data +13 to -17°

	Resulting Fitting Error [deg]		
+/- 3 deg	Gaussian	Lorentzian	P-Voigt
Including	-0.061	0.048	-0.042
Excluding	-0.072	0.019	-0.006

Fitting Error = Curve Fit Center - Num. Int. Center

Pre-Design Analysis (cont.)

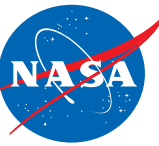

- Evaluated TDU-1 FP data subset with three variables of interest:
 - Collection range large and small:
 - Small $\pm 7^\circ$, possible with graphite rod diagnostic or swept probe arrays.
 - Large $\pm 15^\circ$, only possible with swept probe arrays.
 - Center $\pm 3^\circ$ recess handling condition:
 - Include in curve fit.
 - Exclude from curve fit.
 - Fitting profiles investigated:
 - Gaussian, Lorentzian, and Pseudo-Voigt (combination of Gaussian and Lorentzian).
- Data sets selected as asymmetric to emphasize fitting errors.

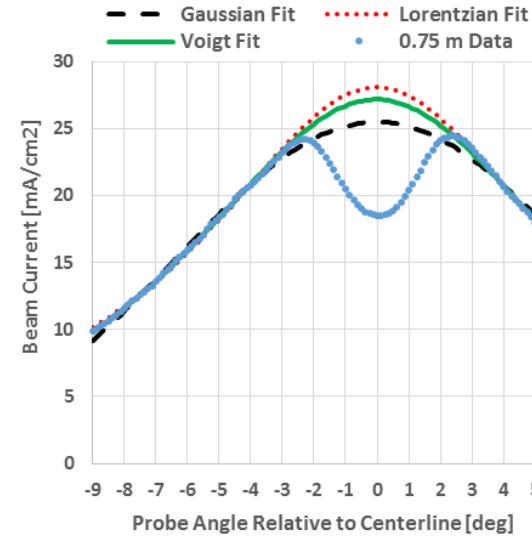

TDU-1 FP Data +5 to -9°

+/- 3 deg	Resulting Fitting Error [deg]		
	Gaussian	Lorentzian	P-Voigt
Including	0.436	0.523	0.436
Excluding	0.048	0.041	0.035

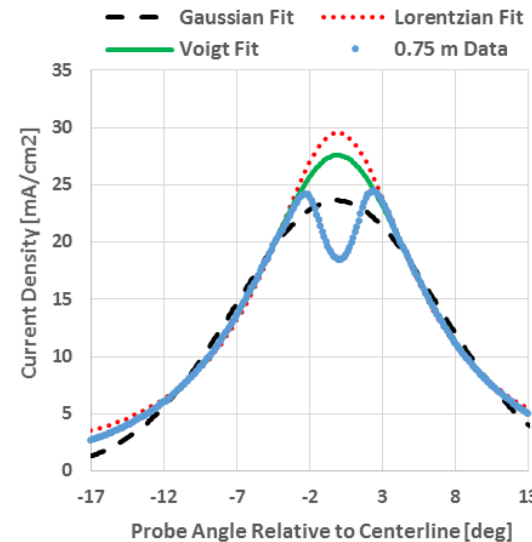

TDU-1 FP Data +13 to -17°

+/- 3 deg	Resulting Fitting Error [deg]		
	Gaussian	Lorentzian	P-Voigt
Including	-0.061	0.048	-0.042
Excluding	-0.072	0.019	-0.006

Fitting Error = Curve Fit Center - Num. Int. Center

Pre-Design Analysis (cont.)

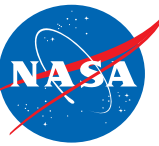

- Evaluated TDU-1 FP data subset with three variables of interest:
 - Collection range large and small:
 - Small $\pm 7^\circ$, possible with graphite rod diagnostic or swept probe arrays.
 - Large $\pm 15^\circ$, only possible with swept probe arrays.
 - Center $\pm 3^\circ$ recess handling condition:
 - Include in curve fit.
 - Exclude from curve fit.
 - Fitting profiles investigated:
 - Gaussian, Lorentzian, and Pseudo-Voigt (combination of Gaussian and Lorentzian).
- Data sets selected as asymmetric to emphasize fitting errors.

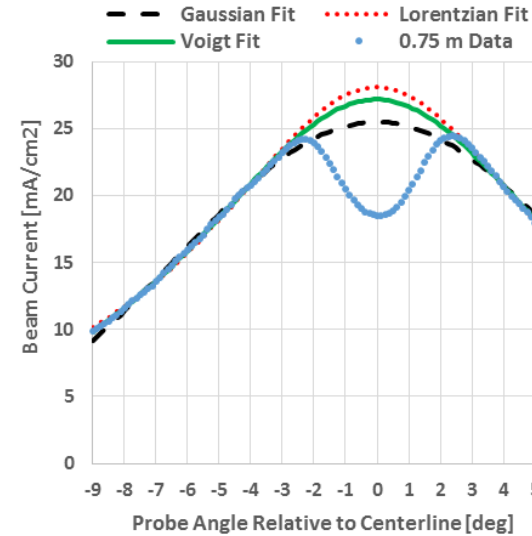

TDU-1 FP Data +5 to -9°

	Resulting Fitting Error [deg]		
+/- 3 deg	Gaussian	Lorentzian	P-Voigt
Including	0.436	0.523	0.436
Excluding	0.048	0.041	0.035

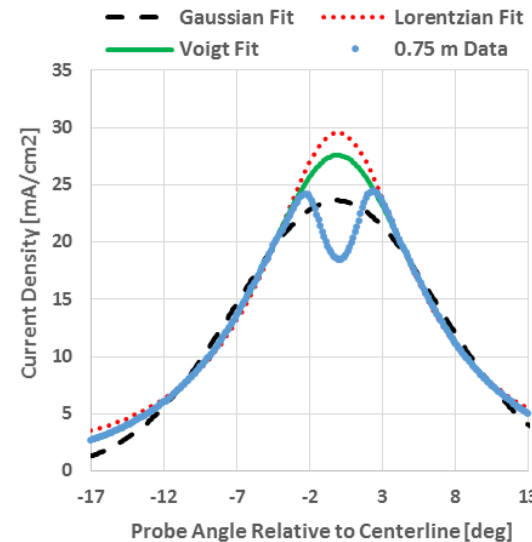

TDU-1 FP Data +13 to -17°

	Resulting Fitting Error [deg]		
+/- 3 deg	Gaussian	Lorentzian	P-Voigt
Including	-0.061	0.048	-0.042
Excluding	-0.072	0.019	-0.006

Fitting Error = Curve Fit Center - Num. Int. Center

Pre-Design Analysis (cont.)

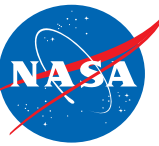

- Evaluated TDU-1 FP data subset with three variables of interest:
 - Collection range large and small:
 - Small $\pm 7^\circ$, possible with graphite rod diagnostic or swept probe arrays.
 - Large $\pm 15^\circ$, only possible with swept probe arrays.
 - Center $\pm 3^\circ$ recess handling condition:
 - Include in curve fit.
 - Exclude from curve fit.
 - Fitting profiles investigated:
 - Gaussian, Lorentzian, and Pseudo-Voigt (combination of Gaussian and Lorentzian).
- Data sets selected as asymmetric to emphasize fitting errors.

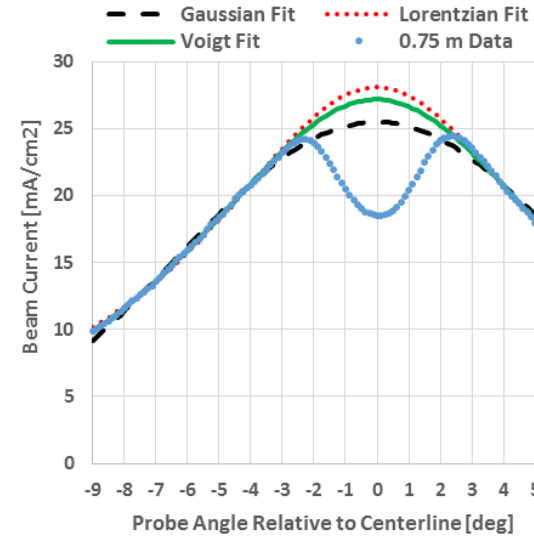

TDU-1 FP Data +5 to -9°

	Resulting Fitting Error [deg]		
+/- 3 deg	Gaussian	Lorentzian	P-Voigt
Including	0.436	0.523	0.436
Excluding	0.048	0.041	0.035

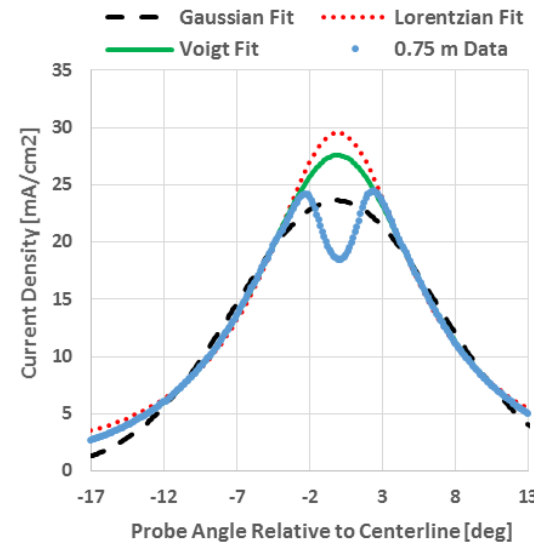

TDU-1 FP Data +13 to -17°

	Resulting Fitting Error [deg]		
+/- 3 deg	Gaussian	Lorentzian	P-Voigt
Including	-0.061	0.048	-0.042
Excluding	-0.072	0.019	-0.006

Fitting Error = Curve Fit Center – Num. Int. Center

Pre-Design Analysis Summary

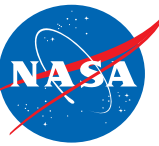

- Given available TDU-1 FP data analysis, the design should ideally:
 - Collect over an angle of at least $\pm 15^\circ$.
 - Use some means to exclude the central recessed region.
 - Use either a numerical integration or Pseudo-Voigt fitting technique.
- Diagnostic constructed of graphite rods does not match the design analysis.
 - Small collection angle, excluded central region represents significant portion of data, long distance to probe emphasizes facility interaction.
- Diagnostic constructed from direct measurement with a thrust stand is not practical for 23 khr test or existing hardware.
- Probe sweep diagnostic is the most practical to satisfy design analysis, design objectives, and AEPS requirements.

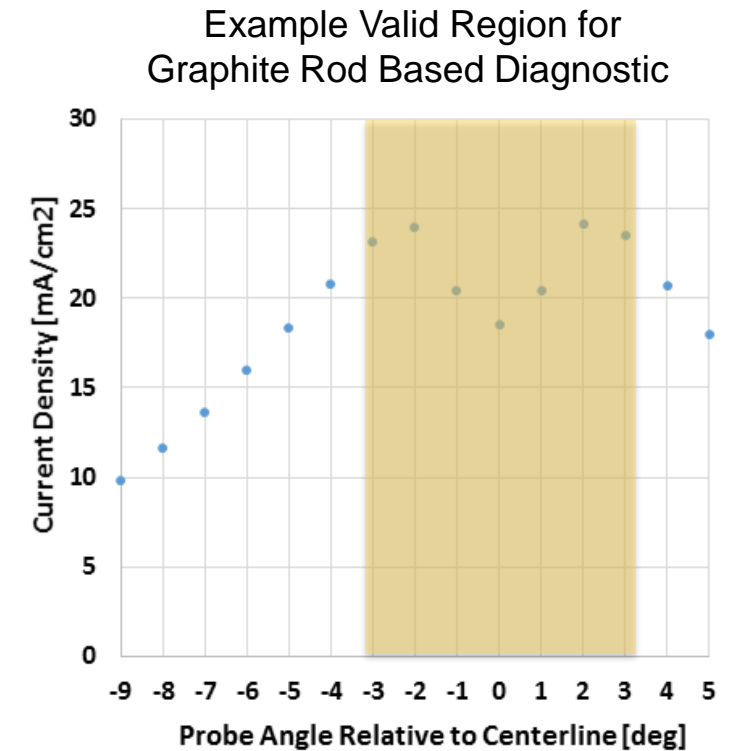

Design Overview



- Thrust vector diagnostic as implemented consists of three main components and an analysis code:
 - I. Thrust Vector Probe (TVP)
 - » Array of Faraday probes mounted on a curved support bracket.
 - II. Thrust Vector Electronics (TVE) package
 - » Data acquisition (DAQ) system and control system for DAQ and stages.
 - III. Thrust Vector Reference (TVR) system
 - » Optical alignment system, inclination tracking system, rotary and linear stage encoders, and stage homing systems.
 - IV. Analysis Code
 - » Use TVR alignment data to correct raw FP data, calculate thrust vector orientation, estimate orientation uncertainty, and compare thrust vector deviation to thrust stand data.

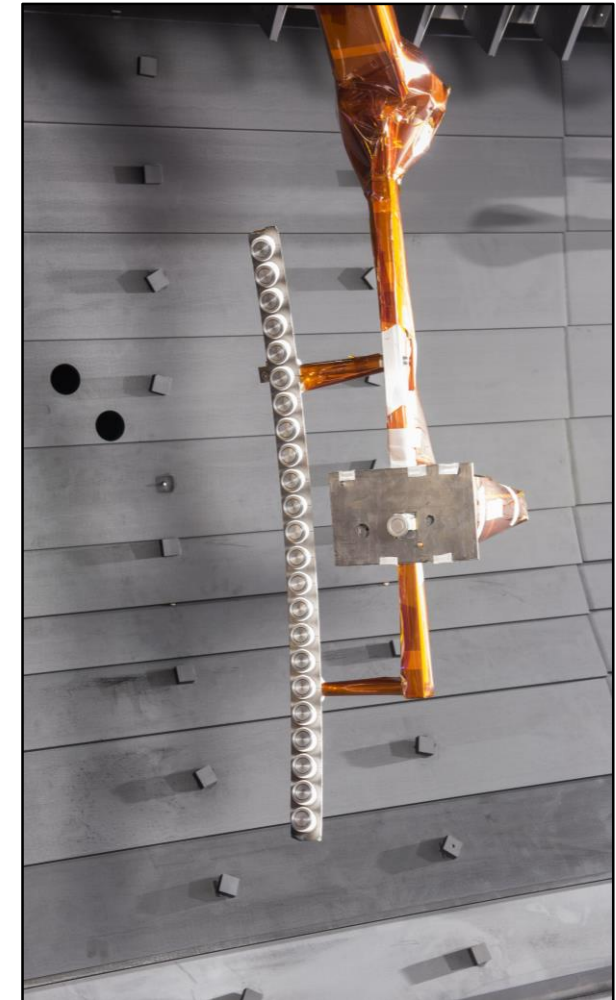

Coordinate System



- When convenient both rectangular and spherical coordinates are used.
 - **Origin** is the intersection of the cathode centerline with the plane of the inner-front pole cover.
 - **X-axis** points opposite gravity.
 - **Z-axis** is the horizontal component of the mounting structure normal vector.
 - **Y-axis** satisfies R.H.R.
 - **Polar angle** φ is relative to X-axis zenith direction.
 - **Azimuthal angle** θ is relative to the Z-axis.
 - **Radius** is fixed at 1 meter.

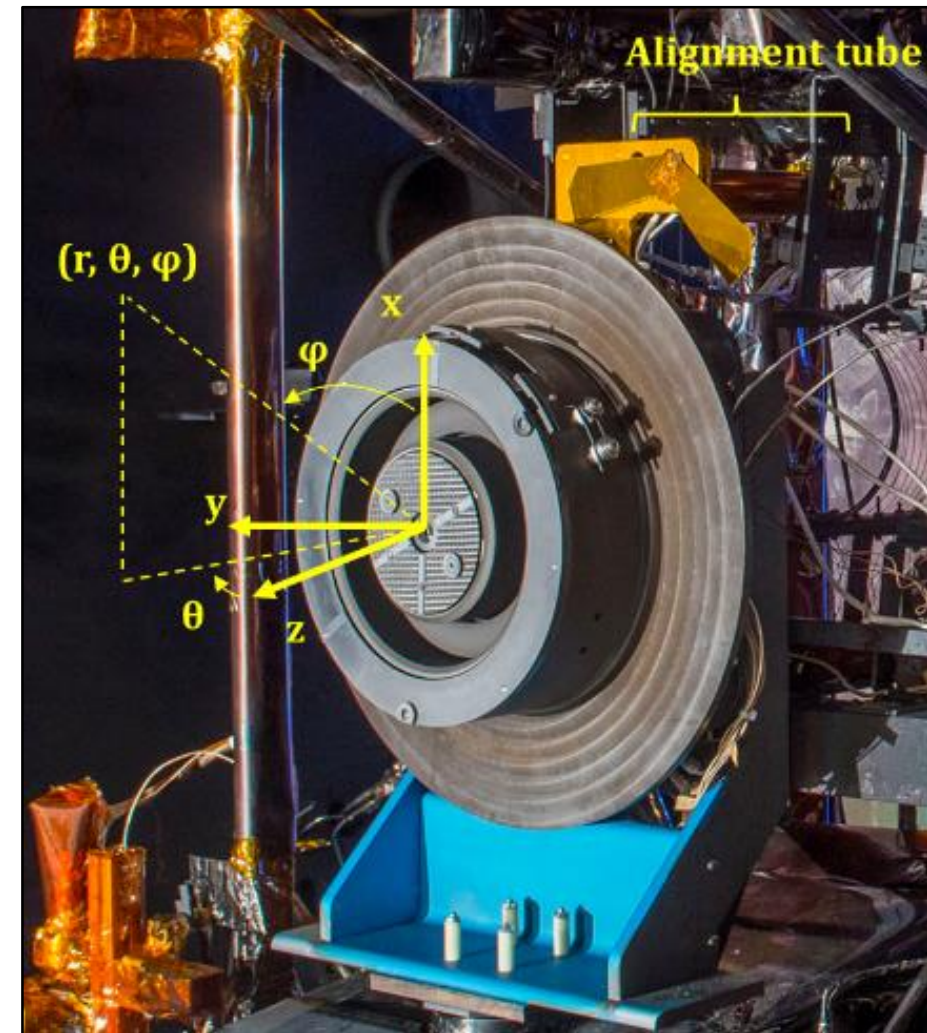

Thrust Vector Probe



- Array of 23 Faraday probes mounted on a 1 meter arc.
- Mounting structure canted 7.5° to account for stand-off distance from the rest of the probe package.
- Faraday probes composed of collector, guard ring, alumina isolators, and mounting hardware.
- Probes positioned vertically every 2° for $\pm 22^\circ$ range.
- Probes oriented with normal vector pointing to the nominal coordinate system origin.
- Guard and collector are biased to $-30V$ relative to facility.
- 61 conductor wire harness composed of twisted shielded pair, shields tied to facility at feed-through.

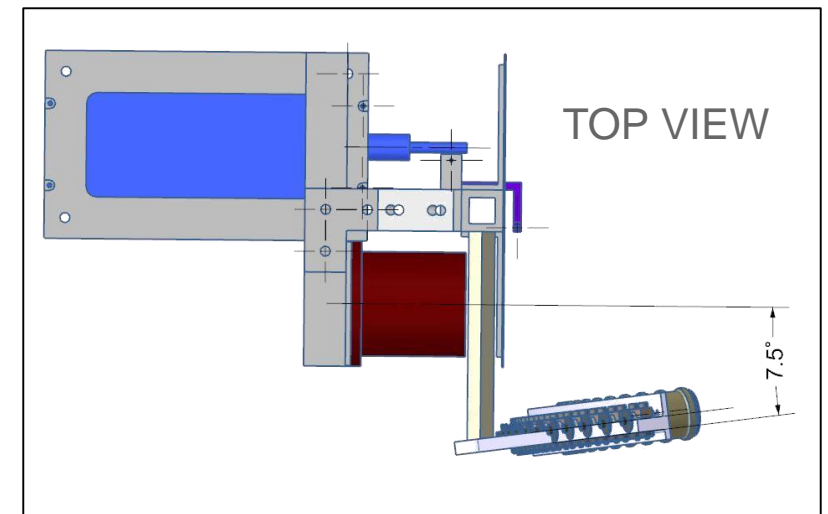
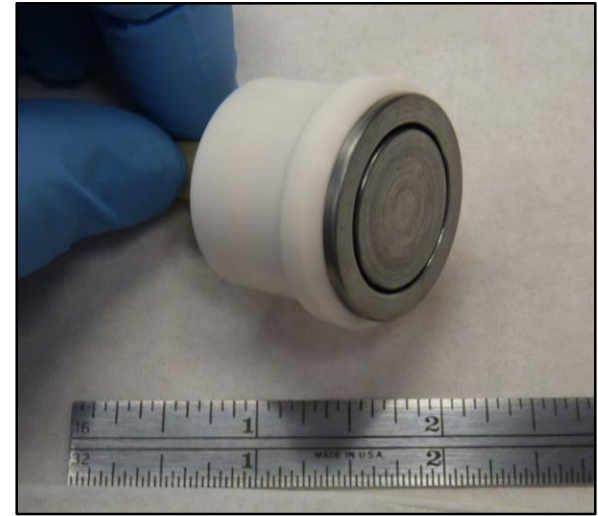

Thrust Vector Electronics Package



- Connectorized rack-mount package contains hardware.
- Two 16 bit DAQs.
 - One DAQ for guard signals and one DAQ for collector signals.
- Two 30 W, 60 V DC power supplies.
 - One supply for guards and one for collectors.
- 100 Ω shunts, 3:1 voltage dividers, and diode over-voltage protection boards.
 - Every guard and every collector has its own channel.
- Four Type-K thermocouples placed on various locations on the TVP.
- LabVIEW control software to operate DAQ, motion stages, and perform preliminary analysis.

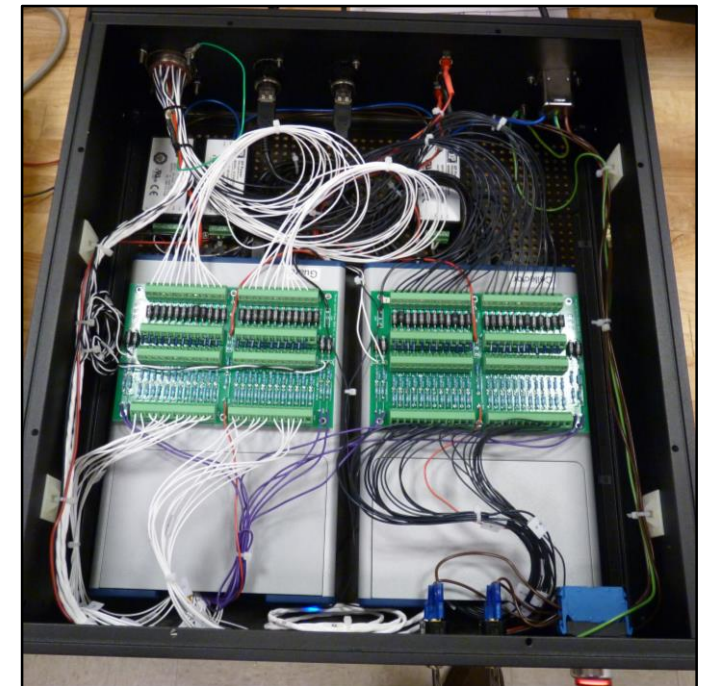

Thrust Vector Reference (TVR) System



- Motion platform composed of a linear stage, and a rotary stage.
 - Linear stage has $<20 \mu\text{m}$ encoder resolution.
 - Rotary stage has <20 arc sec encoder resolution.
- Reference system also consists of an external optical alignment verification system and an internal inclination alignment system.
 - Optical system can provide absolute alignment verification at a single alignment point.
 - Inclination system can provide relative alignment verification at any probe position.

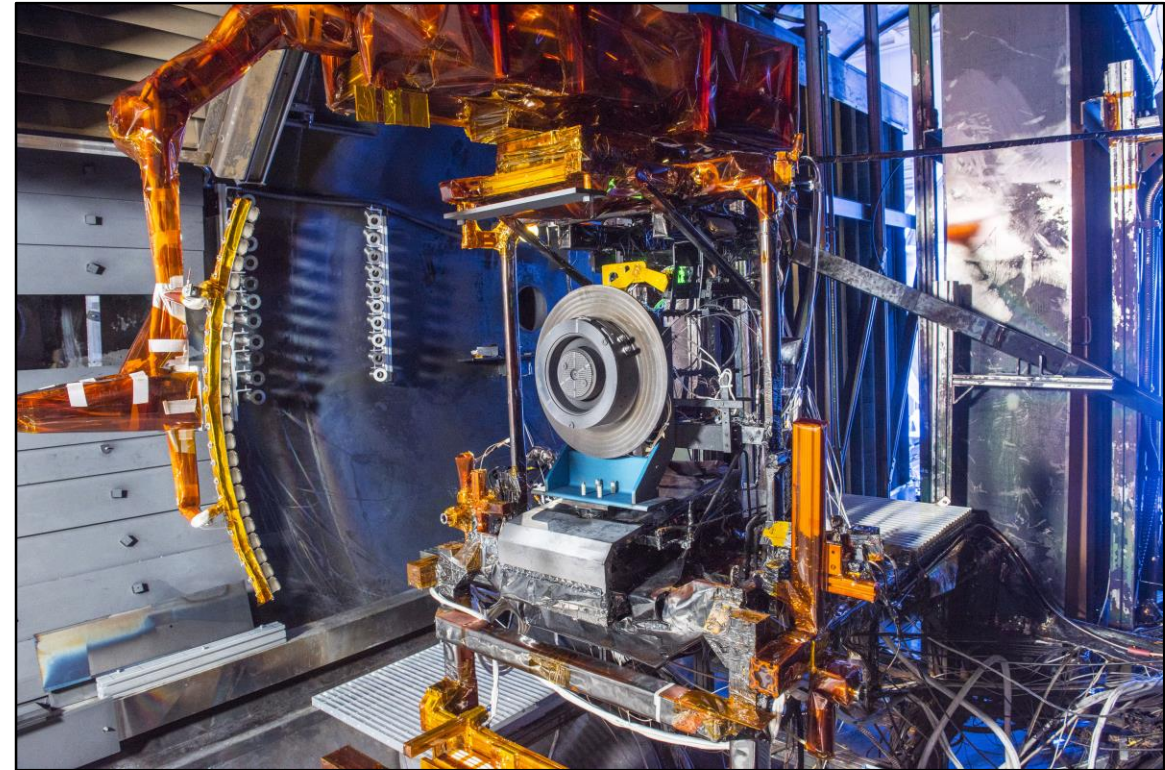

TVR- Optical Alignment System

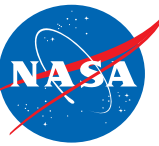

- External verification system consists of four main components:

- Alignment telescope outside of facility, downstream of thruster.
- TVP alignment pin.
- TDU mounting structure.
- Alignment reticle assembly on mounting structure.

- Telescope can be leveled and aligned with mounting structure normal.
- System has been demonstrated both in air and in vacuum (right).
 - System capable of tracking changes in θ and φ as small as 0.05° .

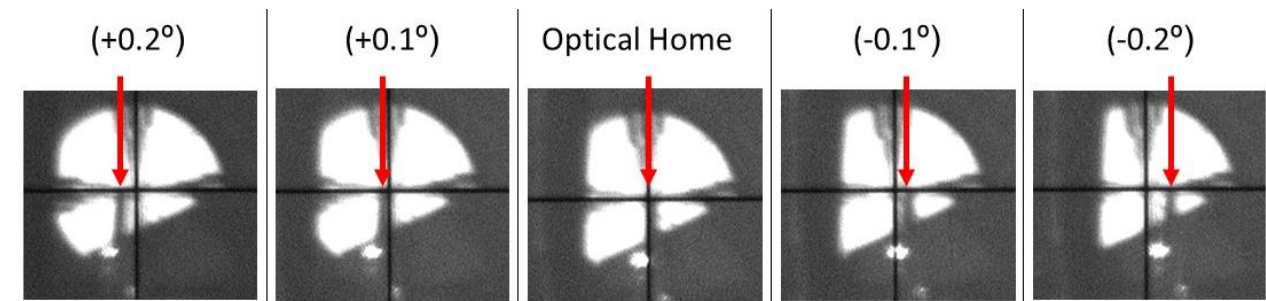
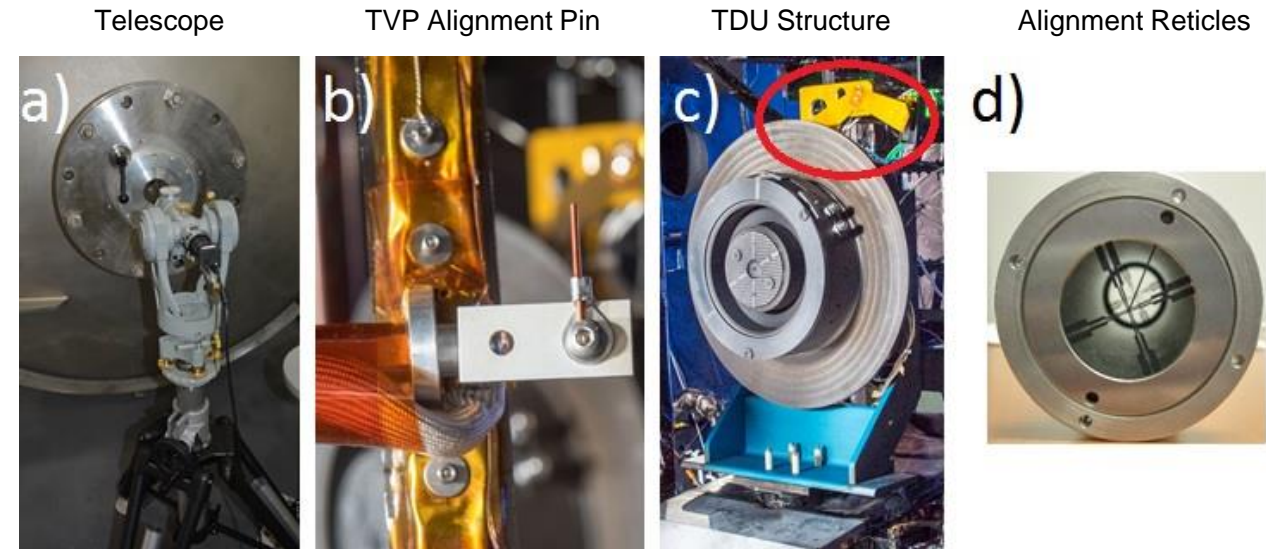

TVR- Inclinometer Alignment System

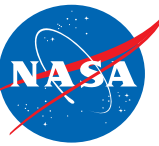

- Internal inclination system consists of a set of electrolytic tilt sensors mounted on probe arm.
 - 1 mV/arc sec sensitivity.
 - Three inclinometers track two orthogonal orientations with redundancy.
 - Probe assembly centerline can be determined to a high level of accuracy (orange arrow, right).
- System has been demonstrated both in air and in vacuum (right).
 - Raw data is curve fit, background corrected, and analyzed to find centerline orientation.
 - Centerline orientation of dataset shown is: [0.999,-0.015,0.012]

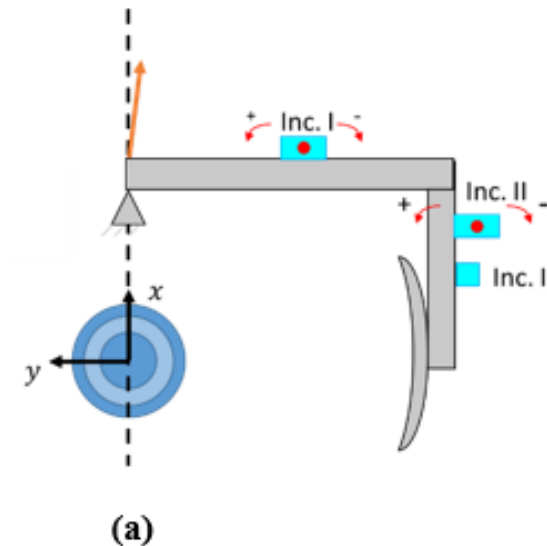

Raw Data & Regression

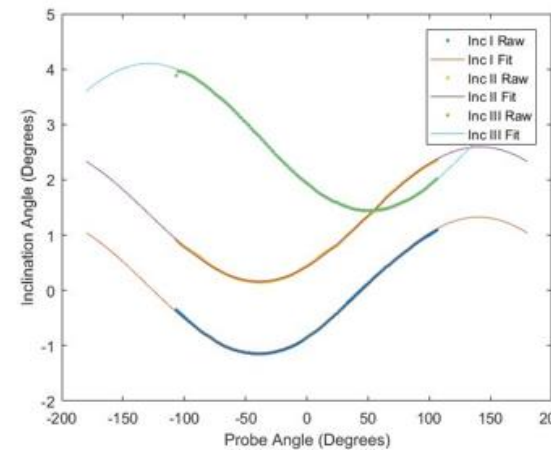

(a)

Background Subtracted

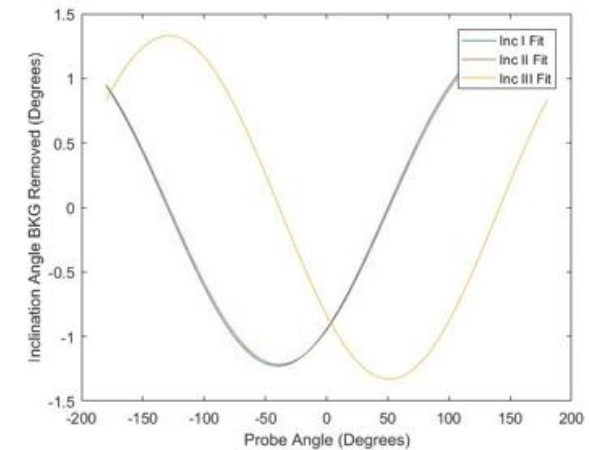

(b)

Initial Measurements

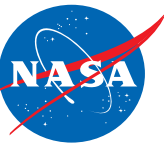

- FP data of scans produces normalized contour plots of Sweep angle (θ) and Probe angle ($90^\circ - \varphi$).
- Preliminary “uncorrected” data is shown for 300, 400V, and 600V operation (right).
 - Profile shows smaller divergence of plume at 600V than 300V.
 - Plume center not yet quantitatively characterized.

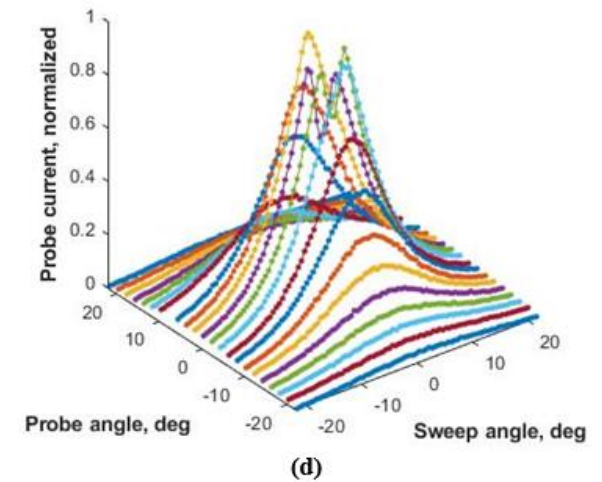
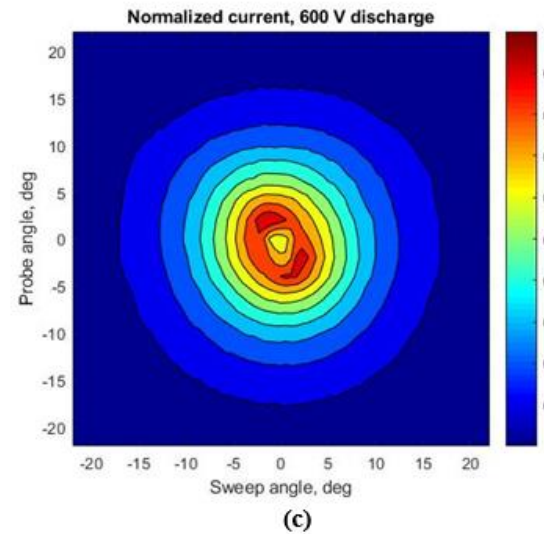
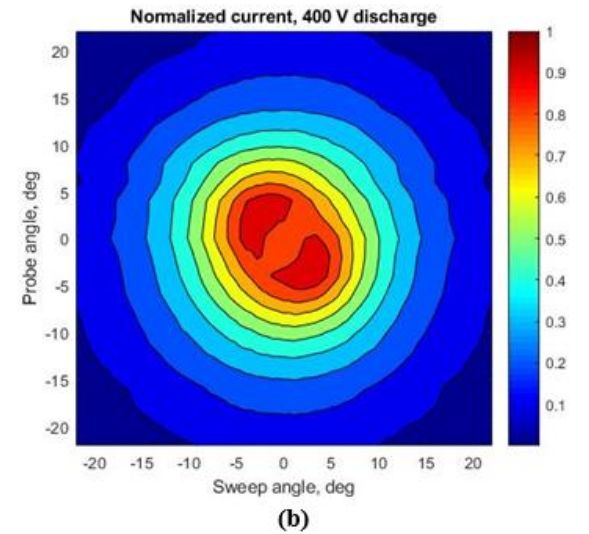
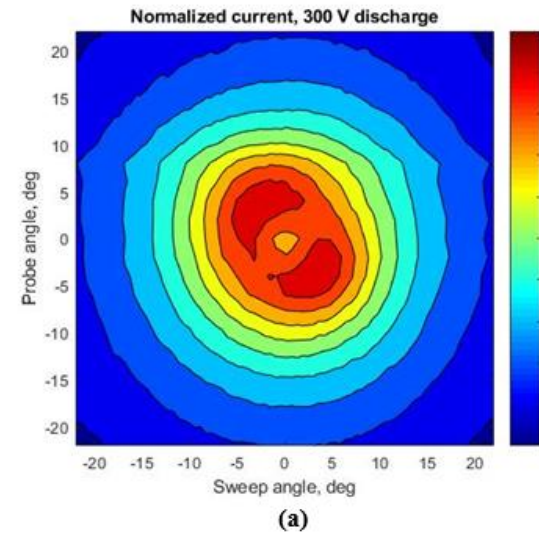

Summary



- Limited design analysis has helped determine the best approach to satisfy AEPS requirements for the EDU long duration testing.
- A Faraday probe array thrust vector diagnostic has been designed, installed, and a preliminary checkout has been completed.
- A preliminary data-set has been collected and qualitatively interpreted to demonstrate system functionality of all critical components.

Acknowledgments



- The authors would like to thank the Space Technology Mission Directorate through the Solar Electric Propulsion Technology Demonstration Mission Project for funding the development of this diagnostic as well as for providing funding for the development of the HERMeS Hall thrusters.

Questions?