



Autonomous Power Controller For the NASA Human Deep Space Gateway

Jeffrey Csank, James Soeder, Jeffrey Follo, Matthew Muscatello, Marc Carbone,
and Yu Hin (Billy) Hau

NASA Glenn Research Center
Cleveland, OH

2018 International Energy Conversion Engineering Conference

APS-02. Space Systems Power Management and Control

July 10, 2018

Cincinnati, OH

Agenda



- **Future of Human Exploration**

- Lunar Orbiting Platform – Gateway (LOP-G)
- Challenge of deep space human exploration

- **Autonomous Power Control**

- What is autonomous power control
- Autonomous power control architecture
- Ongoing efforts in autonomy for power
- Demonstration results

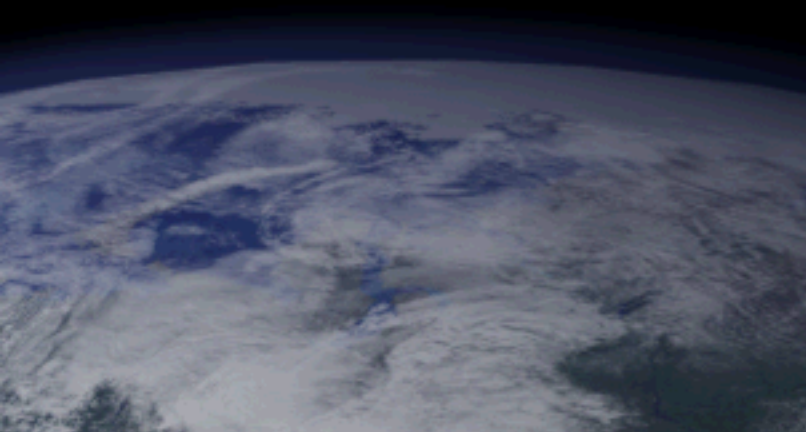
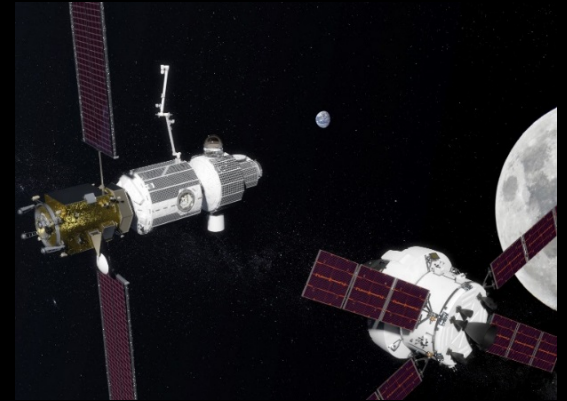

NASA's Vision of Future of Human Exploration

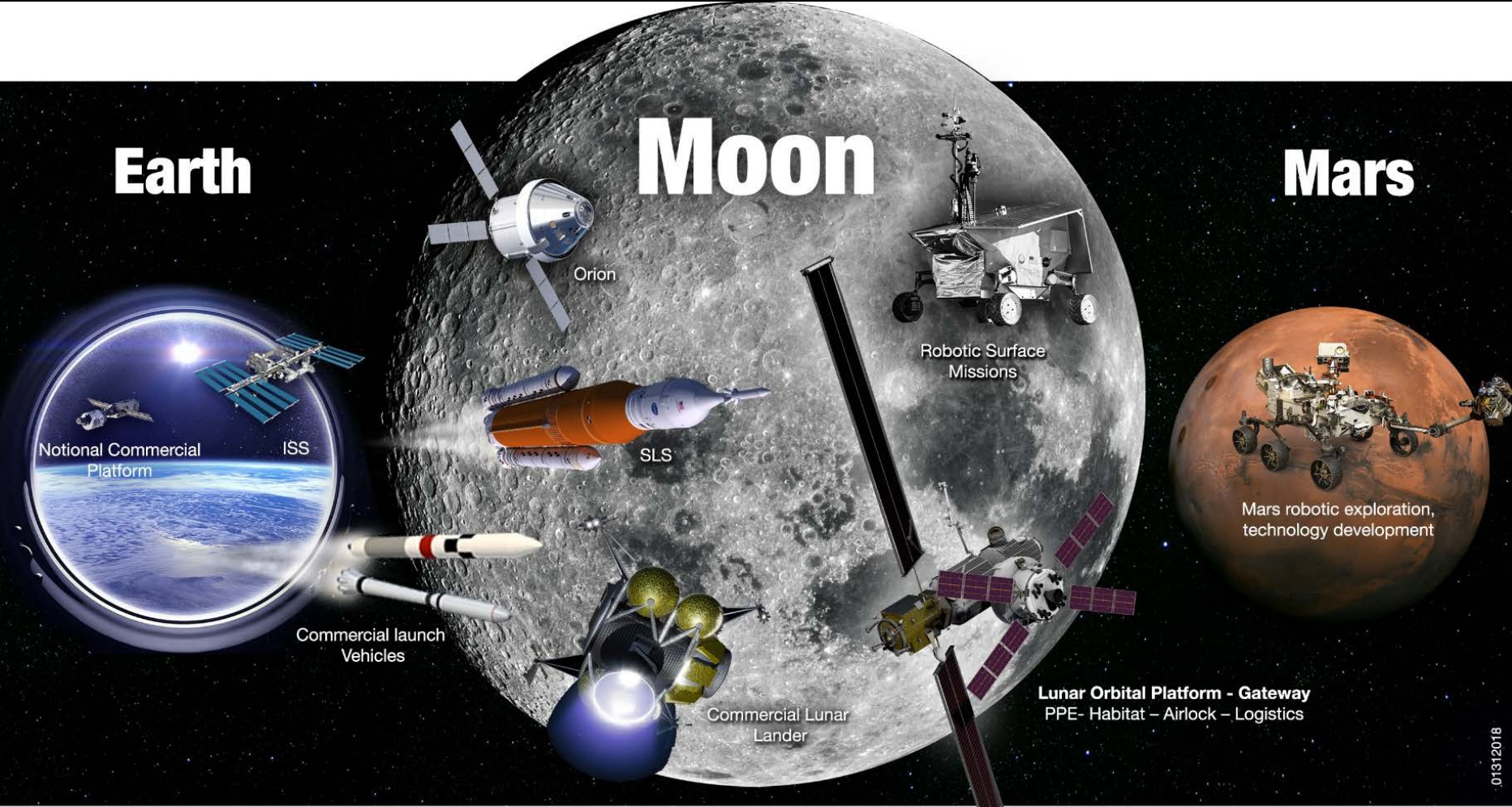

Earth

Moon

Mars

Notional Commercial Platform

Commercial launch Vehicles

Orion

SLS

Commercial Lunar Lander

Robotic Surface Missions

Lunar Orbital Platform - Gateway
PPE - Habitat - Airlock - Logistics

Mars robotic exploration, technology development

In LEO
Commercial & International partnerships

In Cislunar Space
A return to the moon for long-term exploration

On Mars
Research to inform future crewed missions

Lunar Orbiting Platform - Gateway



- **Docking station for deep space exploration and consists of**
 - PPE
 - Habitat
 - Airlock
- **NRHO Orbit**
 - Earth eclipses
 - Moon eclipses
- **Used as a staging ground for robotic and crewed lunar surface missions and for travel to Mars**

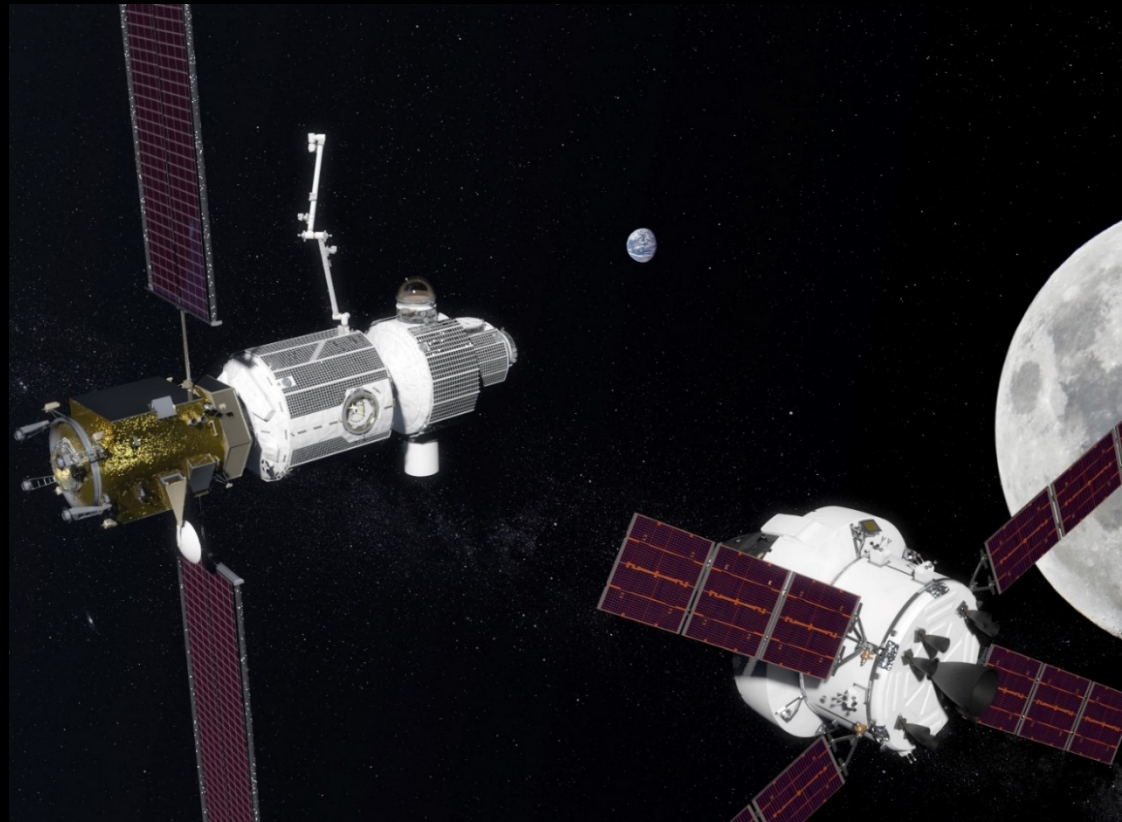



Human Space Exploration

- **International Space Station (Low Earth Orbit)**
 - Distance – 71,322 km
 - One-Way Light Time – 0.24 seconds (TDRS)
- **MARS**
 - Distance 54.6 Million km to 401 Million km
 - One-Way Light Time – 3.04 min to 22.29 min

Ability to communicate and control the spacecraft in real-time becomes a major issue



Traditional vs Autonomous Spacecraft Architecture



Traditional Spacecraft Architecture

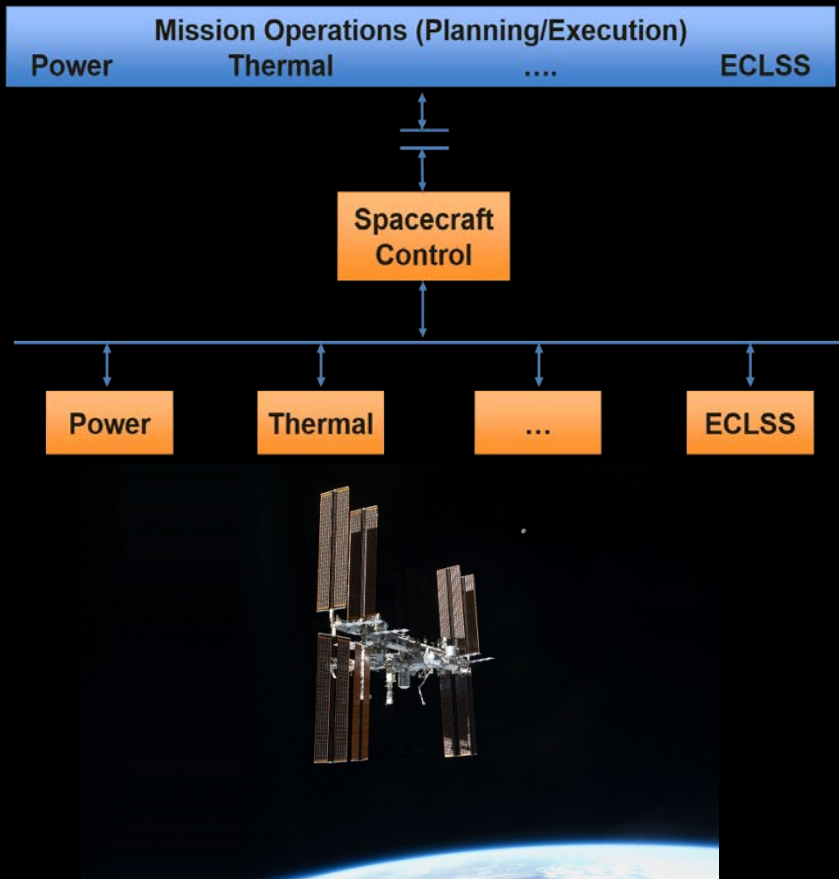

Autonomous Spacecraft Architecture

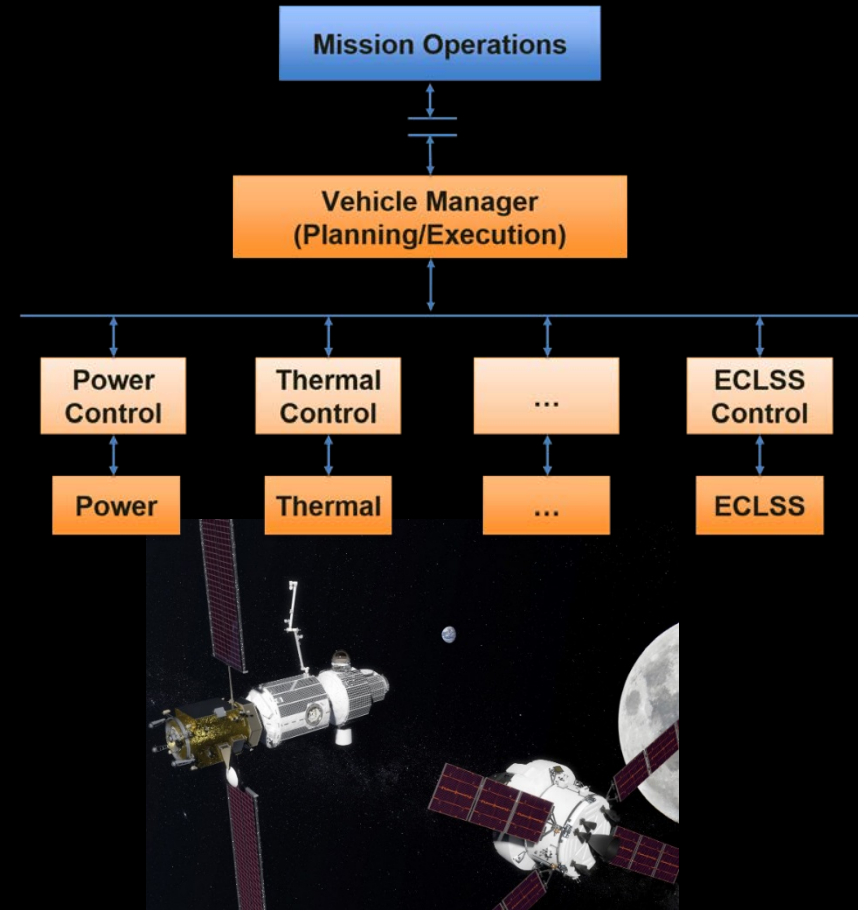

Rely on automation and autonomous systems technology to safely operate spacecraft



Autonomous Power Control

What is an Autonomous Power System?

- **Power System Needs**

- Operate safely at all times
- Service the highest priority loads within the constraints of the generation and distribution system
- Permit humans to consent to any operations / actions during habitation

- **Power System Control Needs**

- Interact with the System (Vehicle) Manager to safely execute the mission
- Oversee/control the power system to provide desired capability without human intervention

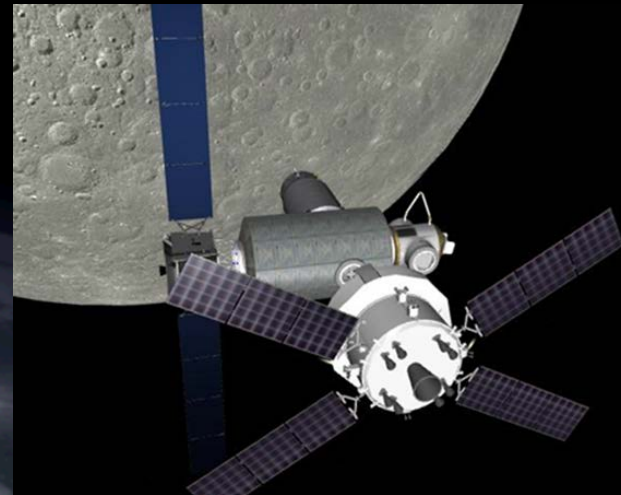

Vehicle Autonomous Power Control Architecture



- **Mission Operations**
 - Monitors vehicle operations
 - Adjusts long term mission objectives
- **Vehicle Manager**
 - Plan vehicle operation (Load Schedules, etc) to achieve mission objectives
 - Coordinate vehicle subsystems
- **Autonomous Power Controller**
 - Forecast energy availability and provide power to the highest priority loads
 - Safely operate the EPS hardware.
- **Reactive Layer (Full Digital Control)**
 - Provides close-loop control of the EPS hardware
 - Protect EPS from hard faults (safe the system)

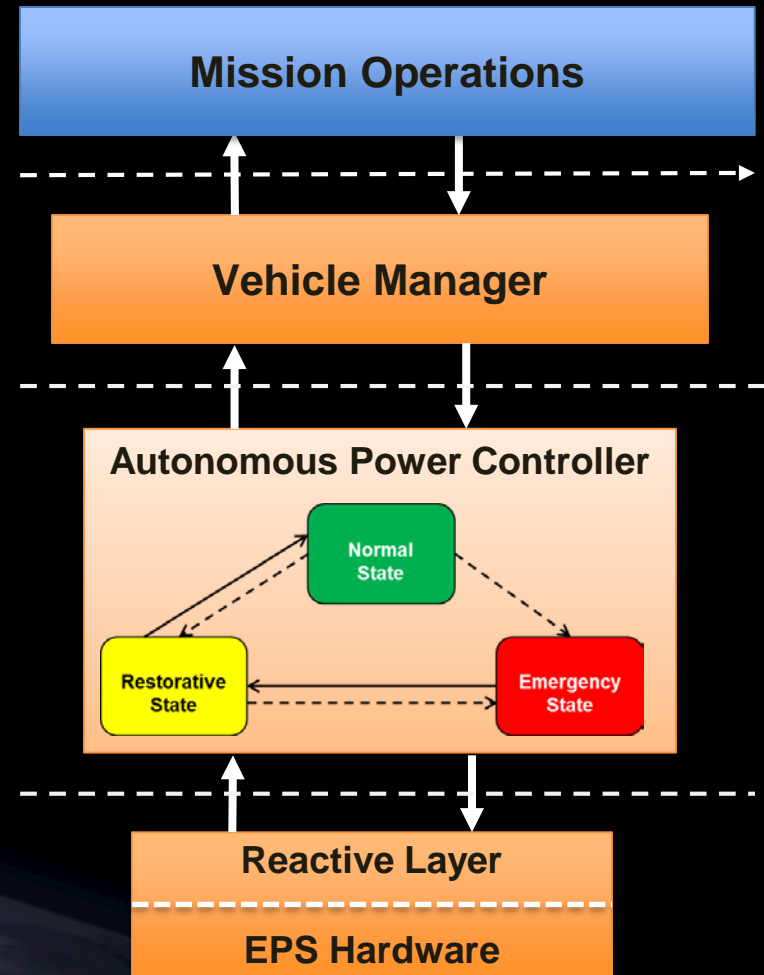



Autonomous Control State Diagram

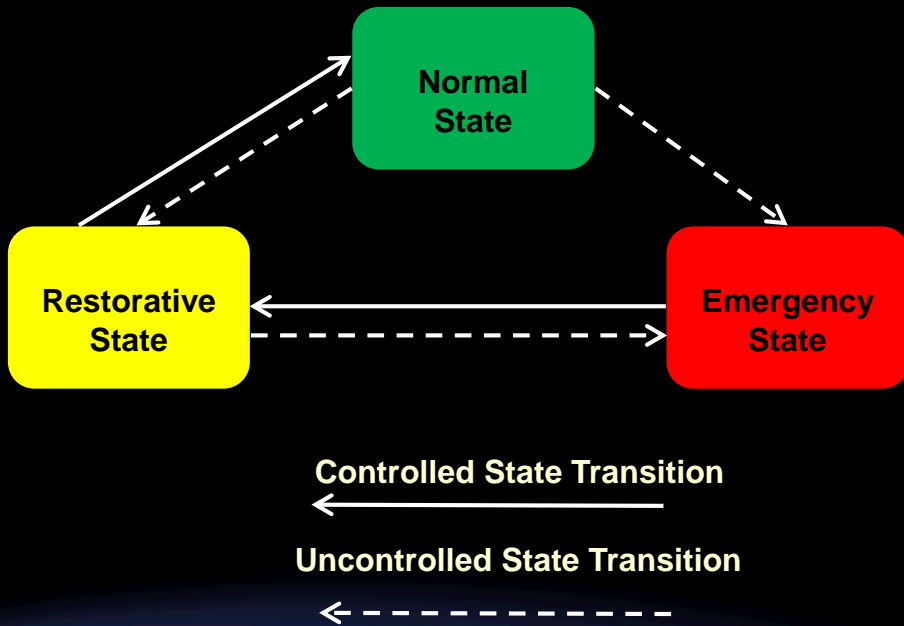

Normal State:

- System operating properly
- Calculates and provides an energy availability and power profile
- Analyzes proposed load schedules
- With no failures, continue indefinitely.

Emergency State:

- Failure has occurred in the EPS
- Reactive control will respond to any immediate faults and temporarily put the system in safe mode.
- APC reconfigures the system

Restorative State:

- System is in a reduced power state and may not be servicing the complete normal load
- APC can perform all the operations of the normal state, with reduced power constraints.

Autonomous Power System



Autonomous Power Controller

Electrical Power System

Note: Future Capability

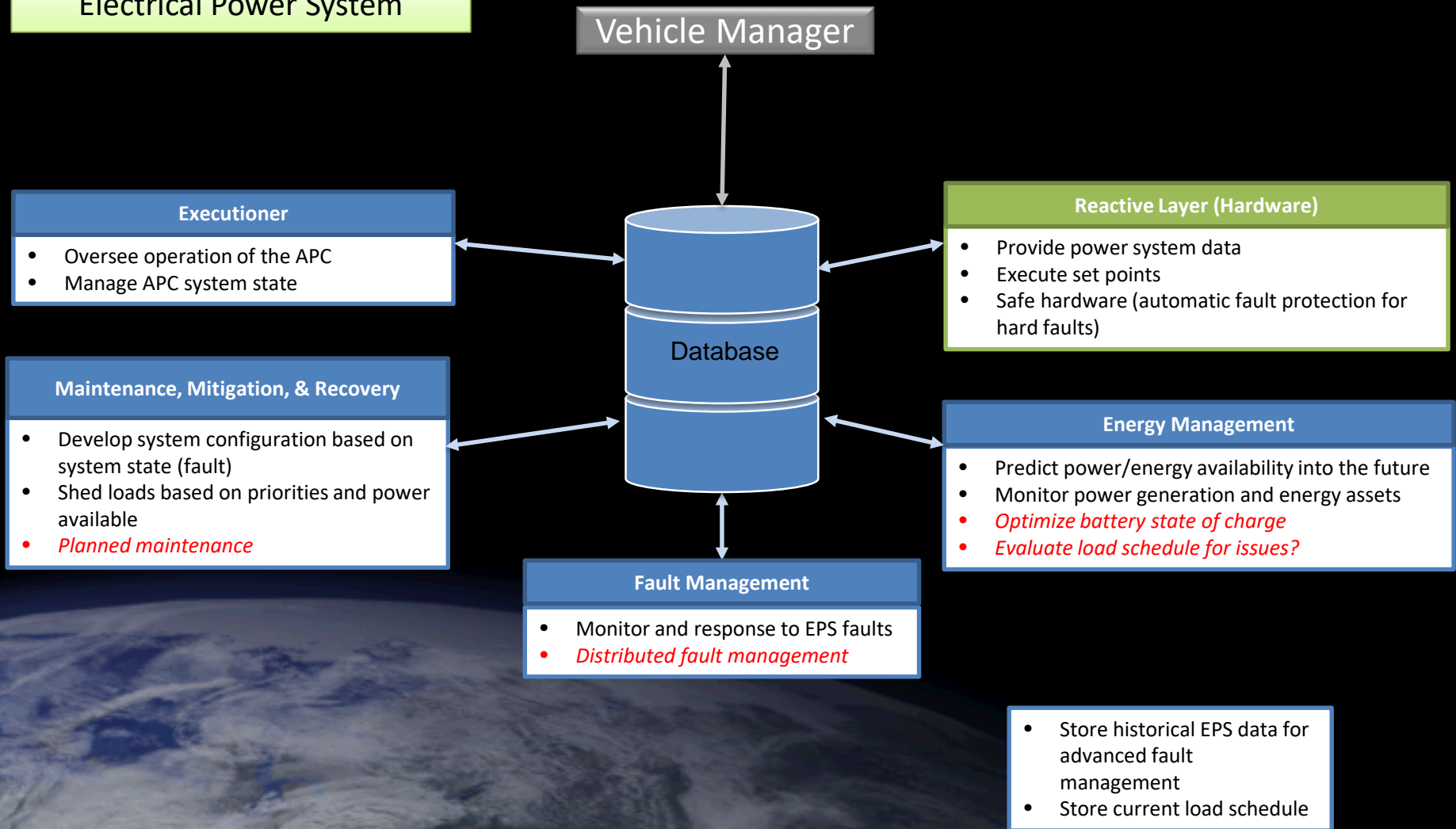



Autonomous Power Control Verification

EPS 2-String System Architecture

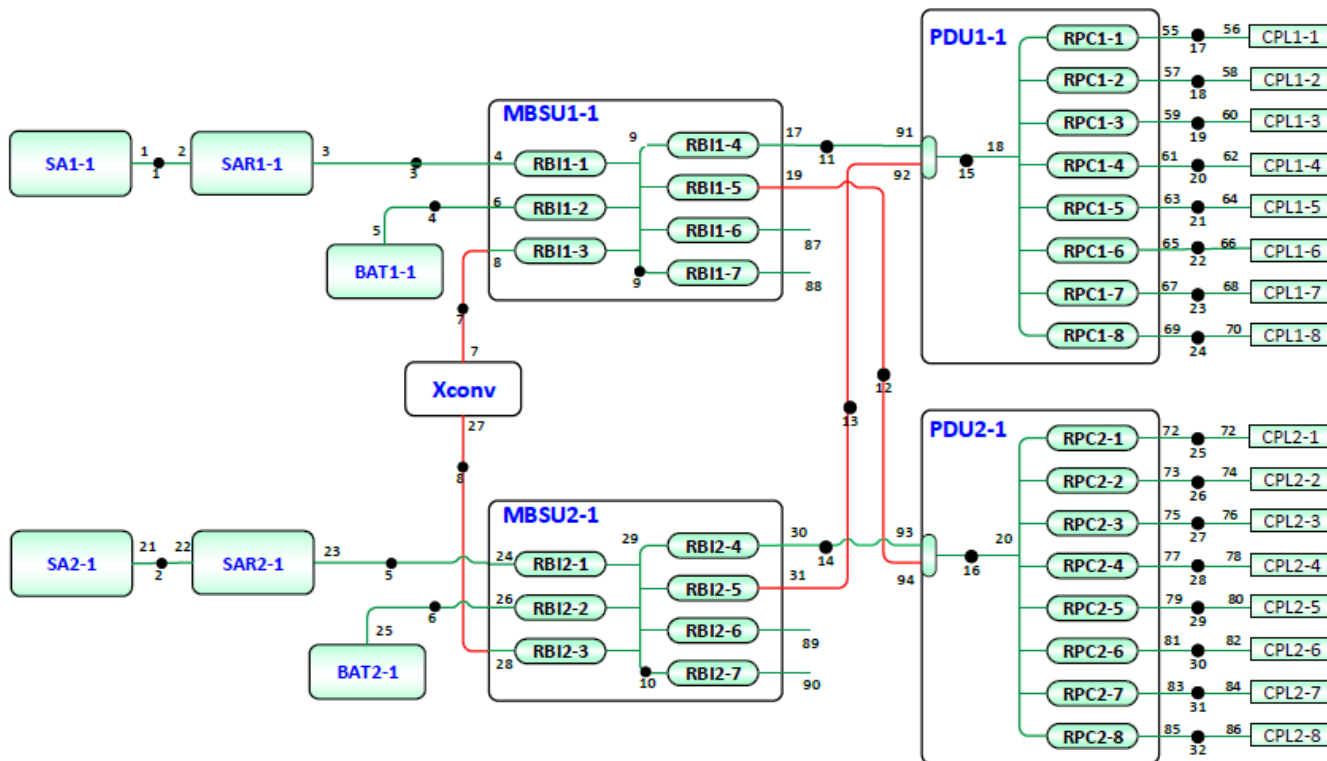

Power System Ratings	Peak	Nominal
RPC Current Rating (Amps)	4	3.2
RPC Power Rating @ 120V (kW)	0.48	0.384
PDU Current Rating (Amps)	32	24
PDU Power Rating @ 120V (kW)	3.84	2.88
Total Power to Loads (kW)	7.68	5.76

System Integration Capability

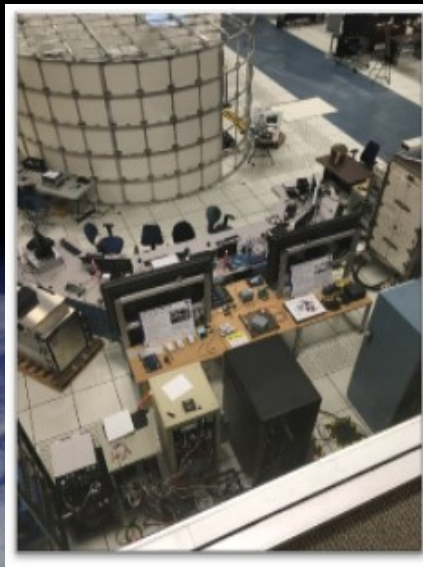
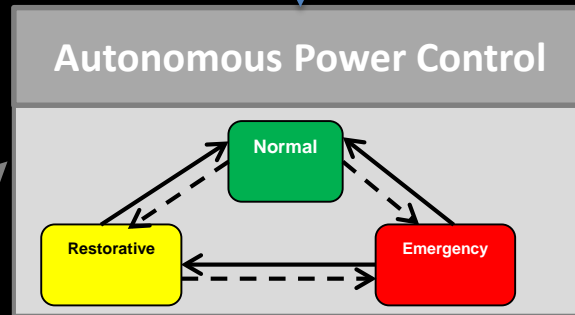

JSC iPAS Test Bed

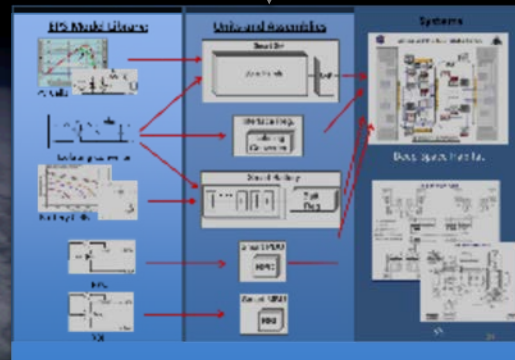

GRC Real Time Simulation



GRC Deep Space Vehicle Power System Test Bed

Demonstrations



Normal Mode

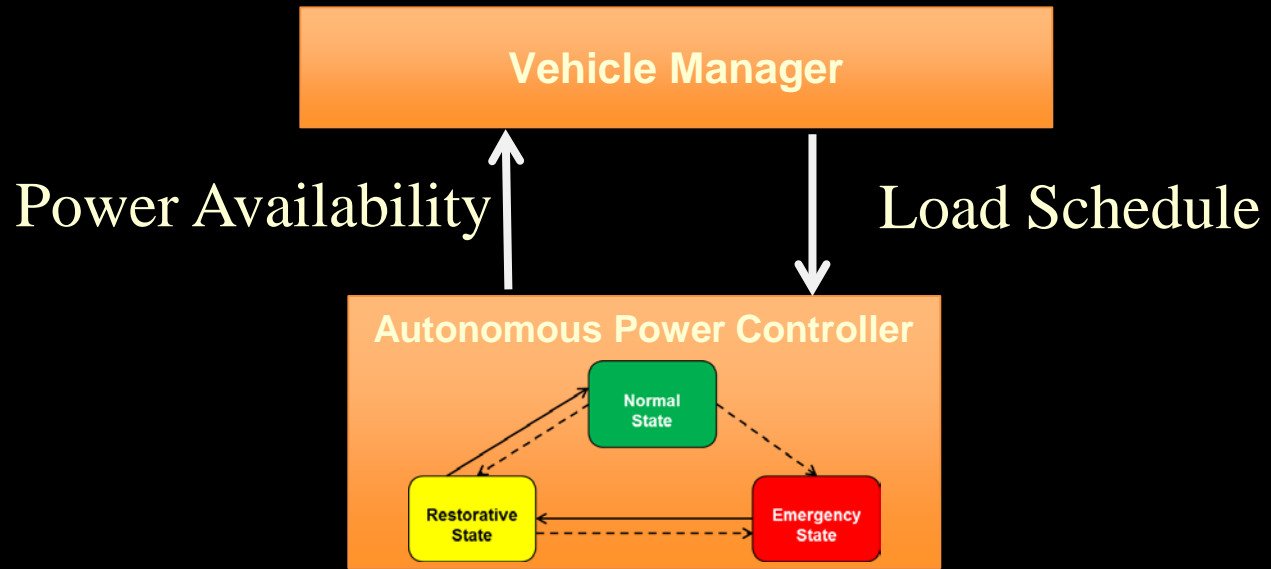

Fault Mode

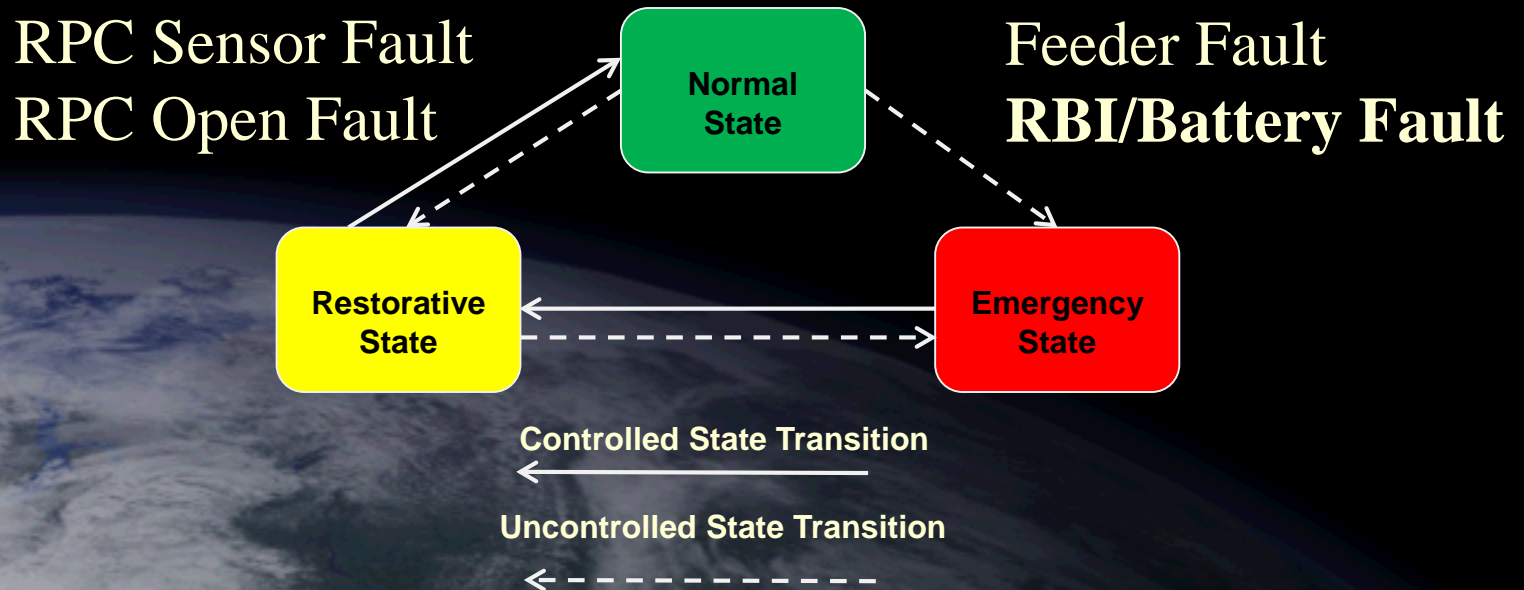



Normal Mode

- VM Requests Energy Availability Profile
- APC responds

time	Peak (kw)	Nominal (kw)	PDU1	PDU2
1	7.68	5.76	Null	Null
2	7.68	5.76	Null	Null
3	7.68	5.76	Null	Null
4	7.68	5.76	Null	Null
...				
24	7.68	5.76	Null	Null

Total energy (kW tu)

138.24



RBI Battery Fault Response

- Send VM updated energy profile.
- VM creates and proposes a new load schedule

time	Peak (kw)	Nominal (kw)	PDU1	PDU2
1	7.68	2.88	Null	Null
2	7.68	2.88	Null	Null
3	7.68	2.88	Null	Null
4	7.68	2.88	Null	Null
...				
24	7.68	2.88	Null	Null

Total energy (kW tu) 69.12

Conclusion



- **Intelligent Power Systems capability is required for long term operation far from earth**
- **Initial autonomous power controller using real-time simulations and hardware in the loop has been demonstrated for simplified hardware configuration.**
- **Technology to operate proposed deep space exploration vehicles can be extended for use with Hybrid Electric Airplanes and operating micro-grids.**

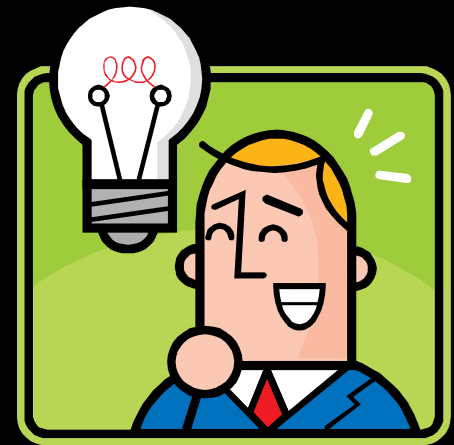

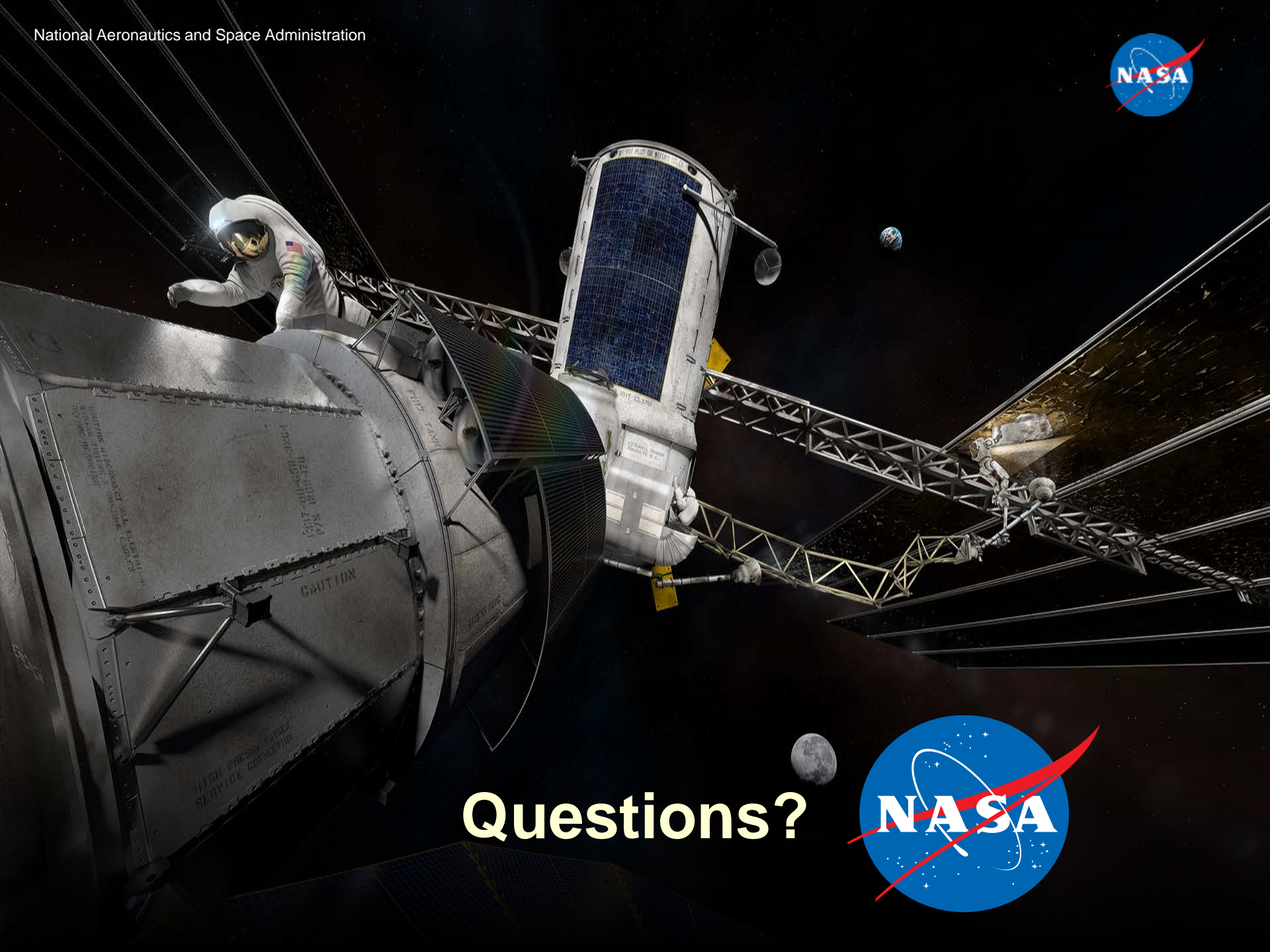

Questions?

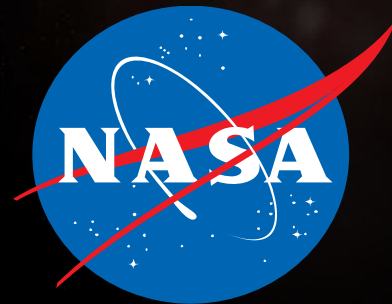

Autonomous Power Control Architecture (Conceptual)

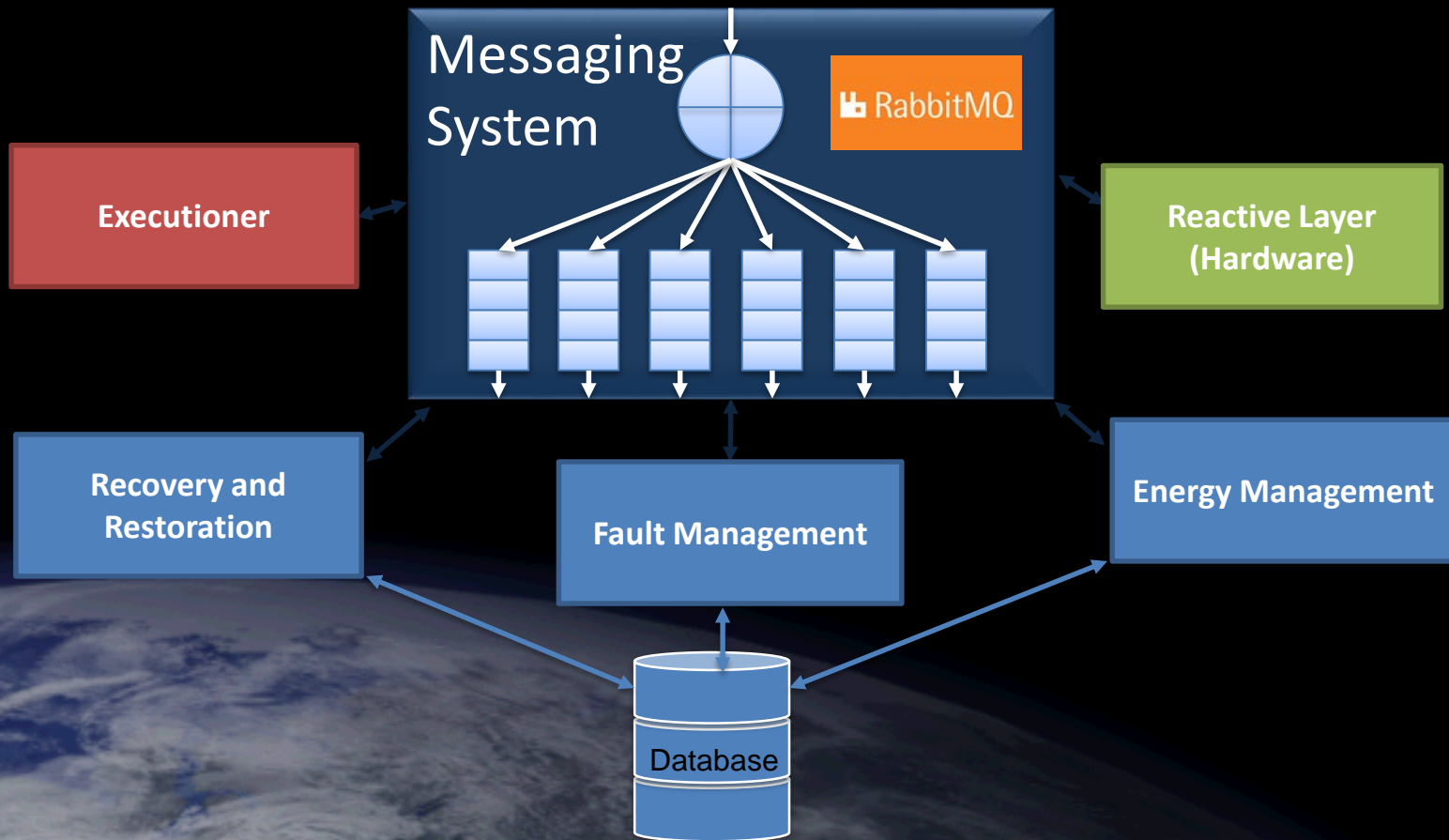

Typical Spacecraft Control Architecture

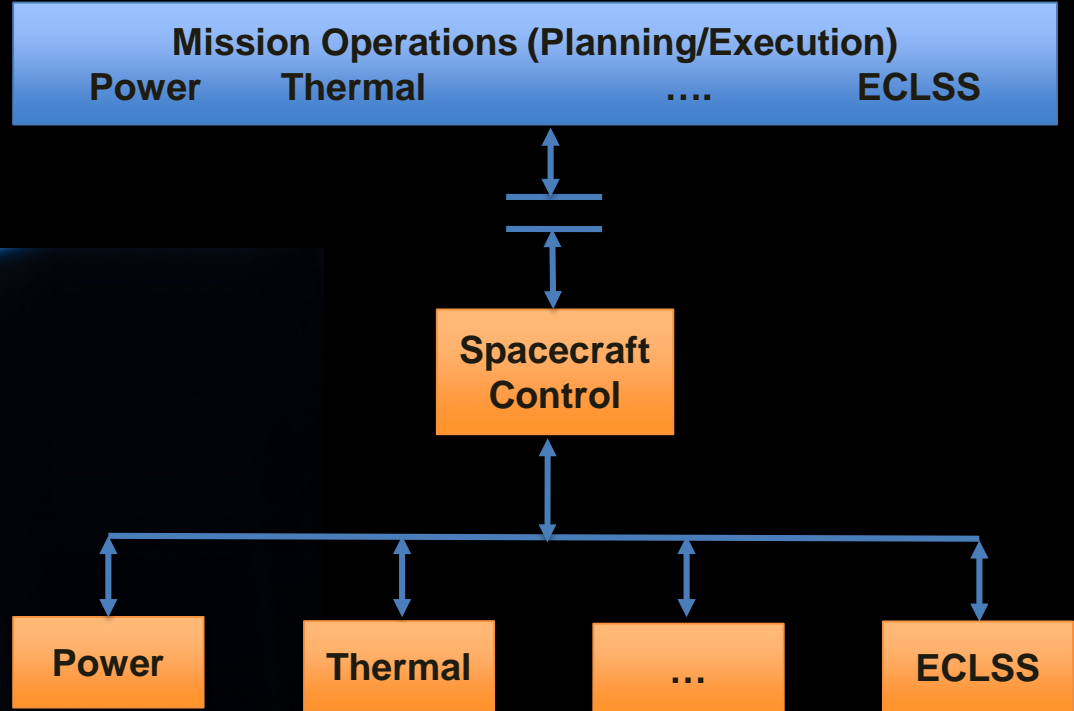
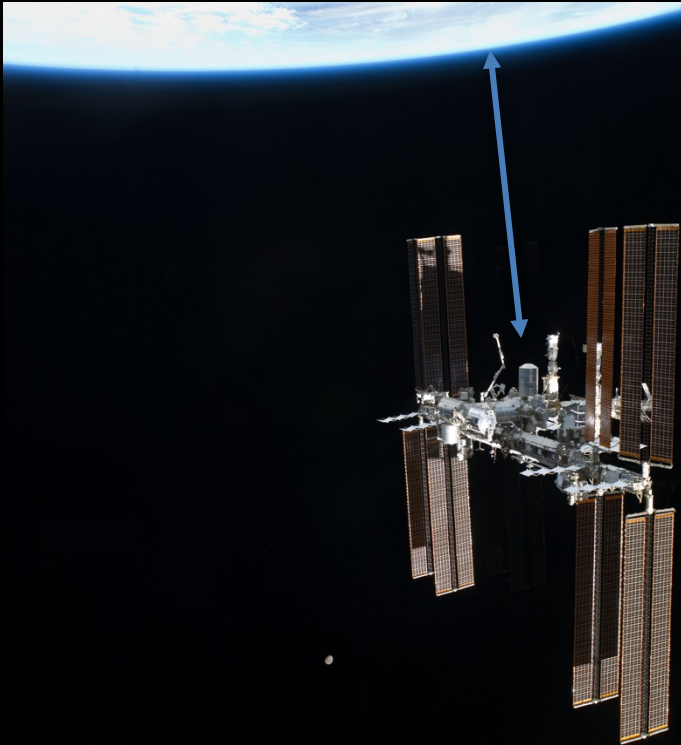

Autonomous Power System (Conceptual)



Autonomous Power Controller

Electrical Power System

Note: *Future Capability*

