

Iodine Hall-Effect Electric Propulsion System Research, Development, and System Durability Demonstration

Gabriel F. Benavides, Hani Kamhawi, Jonathan A. Mackey, and Thomas W. Haag
NASA Glenn Research Center, Cleveland, OH, 44135, USA

and

Gustavo C. C. Costa
Vantage Partners, LLC, Cleveland, OH, 44135, USA

AIAA/SAE/ASEE Joint Propulsion Conference
9 July 2018, Cincinnati, Ohio

AIAA-2018-4422

1. Project Objectives / Motivation
2. Iodine-Compatibility of Feed System and Test Facility Materials
3. Iodine-Compatibility of Cathode Materials
4. Vacuum Facility Improvements for Iodine Handling
5. Demonstration Test Setup
6. Demonstration Results
7. Summary



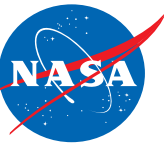

Advanced In-Space Propulsion (AISP) Iodine Hall-effect Thruster (IHT) Project

1. Demonstration of a 600W Hall-effect thruster iodine EP system.
 2. Mature the critical propulsion system components to TRL 5+.
 3. Perform long-duration integrated system testing with iodine.
- **Leveraged Small Business Innovative Research (SBIR) R&D:**
 - Iodine compatible 600W Hall-effect thruster (BHT-600-I)
 - Modular power processing unit (*not delivered prior to test*)
 - Iodine compatible cathodes and feed system components
 - **Tasks address critical Technology Gaps and Risks**
 - BHT-600 engineering/material changes for iodine compatibility
 - Iodine propellant metering
 - Iodine feed system and spacecraft material interactions
 - Wear testing >1000 hrs for both thruster and cathode

Motivations for Iodine

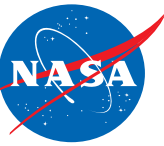

- Iodine or xenon Hall-effect thruster yield similar demonstrated performance.
- Iodine stores at 3X the density of xenon.
- Iodine stores at sub-atmospheric pressure, permitting conformal storage vessel designs.
- Lower cost and greater abundance than xenon.

Iodine Properties:

- Density at 25°C: **4.93 g/cm³**
- Vapor pressure at 25°C: **0.3 torr**
- Atomic weight: 126.904 g/mol
- Cost/kg: \$250 bulk (Sigma-Aldrich)
- Abundance: 4.9×10^{-5} % earth crust
- NFPA: Health 3, Fire 0, Reactivity 0

Xenon Properties:

- Density at 25°C: **1.6 g/cm³**
- Vapor pressure at 25°C: **~2500 psi**
- Atomic weight: 131.293 g/mol
- Cost/kg: \$1,200 (Source ??)
- Abundance: 2×10^{-9} % earth crust
- NFPA Rating: 0, 0, 0

Increased Opportunities for Small Spacecraft

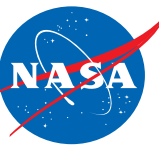

EELV Secondary Payload Adapter (ESPA)

- Qualified in early 2000s
- 6 x 180 kg S/C per ring + primary payload
- 4 x 300 kg S/C per ring + primary payload
- Rings Slots can be further allocated to pairs or groupings of smaller satellites.
- May be stacked such as 11 Orbcomm S/C launched on Falcon 9

ESPA in-process of requalification for increased mass, though same volume

- 6 x 220 kg S/C (1/4" bolt flange)
- 6 x 322 kg S/C (5/16" bolt flange)
- 4 x >>454 kg S/C

ESPA-class S/C may soon dominate market and number of operational S/C on-orbit

Increasing S/C mass, but not volume, encourages increased S/C mass density.

Iodine propellant is 3X more dense than xenon, but provides similar performance, enabling increased delta- v capability within existing spacecraft volume constraints.



11 Orbcomm-OG2 satellites launched on December 21st, 2015.

Source: <https://www.orbcomm.com/en/networks/satellite/orbcomm-og2>



INVESTIGATIONS

Iodine Compatibility of Feed System and Facility Materials

Iodine Compatibility of FS and Facility Materials



- Feed System, Facility, and Coating Materials Studied
 - SS316, SS304, Ti-6Al4V (Ti Grade 5), A36 (Low Carbon Steel), Al-6061-T6
 - Coatings: Silcotek Silcolloy 1000, Silcotek Dursan (Silicon Based Coatings)
- Material testing will continue Summer 2018
 - Including nickel alloys (Hastelloy C-276 and Inconel 625)
 - Implement test apparatus improvements
 - Add second test apparatus including thermal balance for kinetic data
- Publication: *Chemical, Structural, and Microstructural Changes in Metallic and Silicon-Based Coating Materials Exposed to Iodine Vapor*, NASA/TM-2017-219498

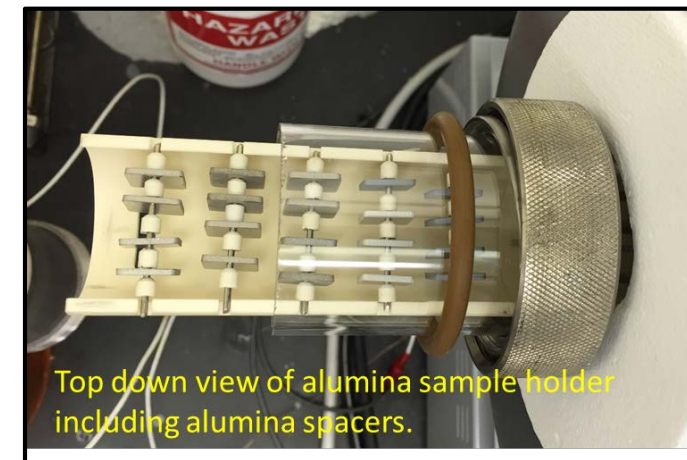
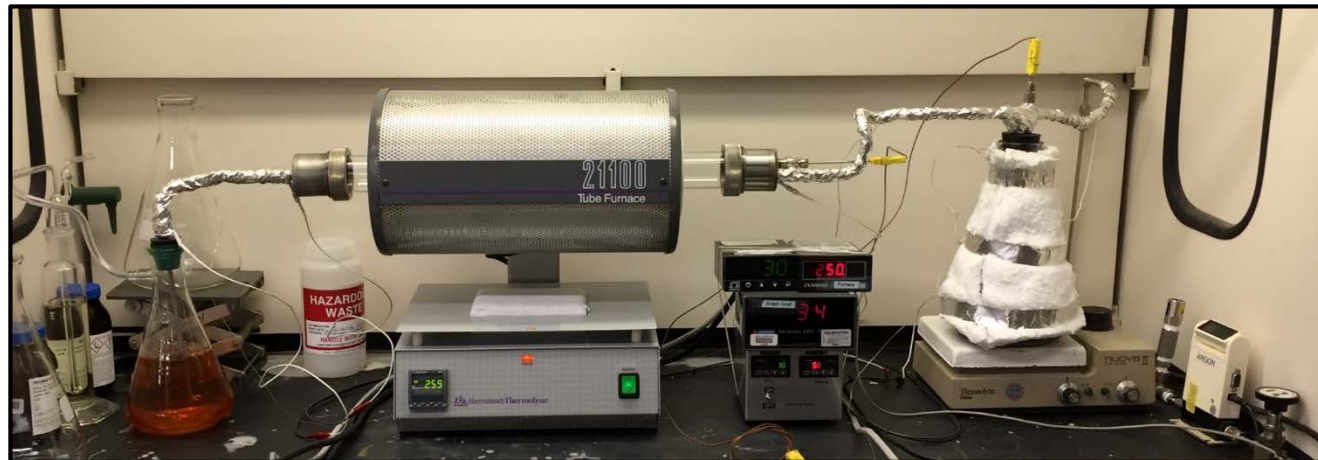

Iodine Compatibility of FS and Facility Materials

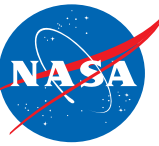

Uncoated material coupons

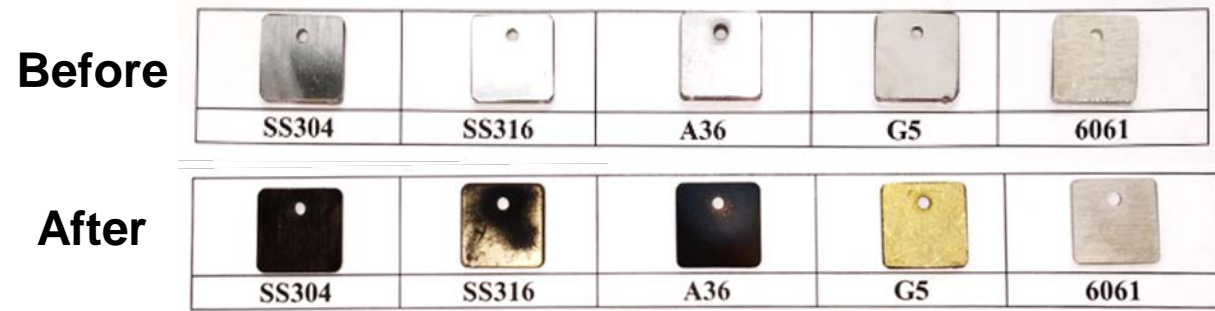

Material	Δ [mg/cm ²]
SS304	0.206
SS316	0.111
A36 Steel	1.514
Ti Grade 5	0.010
Al 6061-T6	0.101

Silicon coated coupons



Material	Δ [mg/cm ²]
SS304	-0.007
SS316	-0.011
A36 Steel	-0.002
Ti Grade 5	-0.007

Iodine Compatibility of FS and Facility Materials

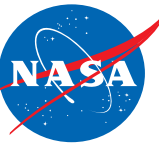

Key Test Results:

- Uncoated Ti and Al showed significant mass loss (corrosion bi-products volatile)
- Corrosion 316SS < SS304 < A36 (by measured mass gain)
- Coated samples showed no statistically meaningful mass change, except for one outlier

Conclusion: Silicon coatings resilient against I₂ and useful for lab and maybe flight applications to prevent/slow iodine reactivity with surfaces.

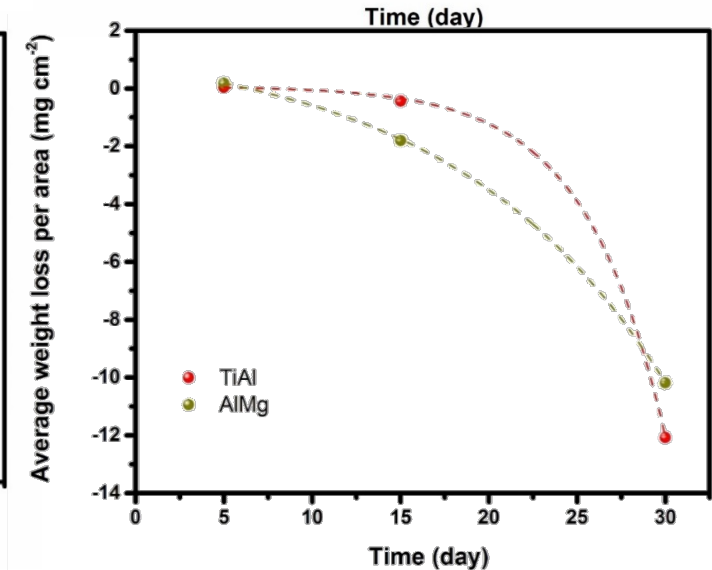
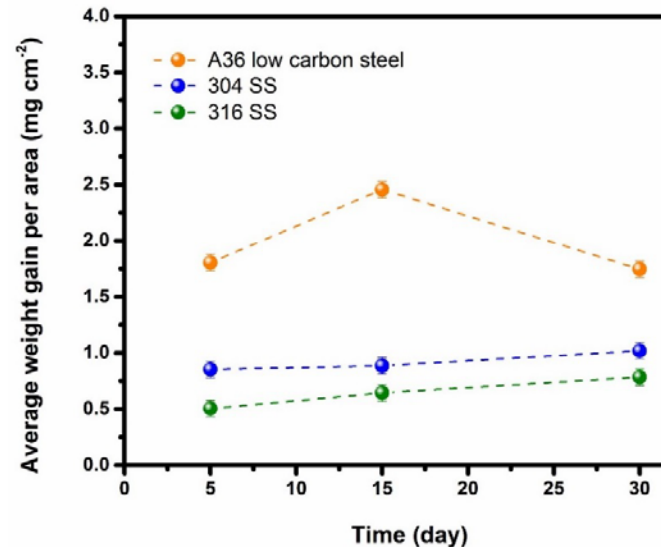
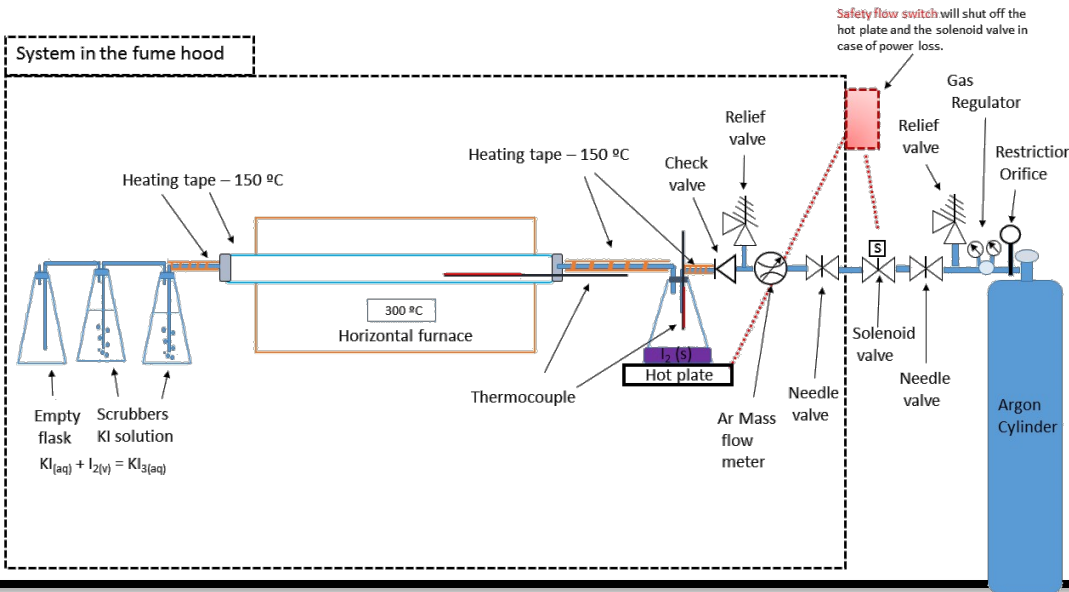
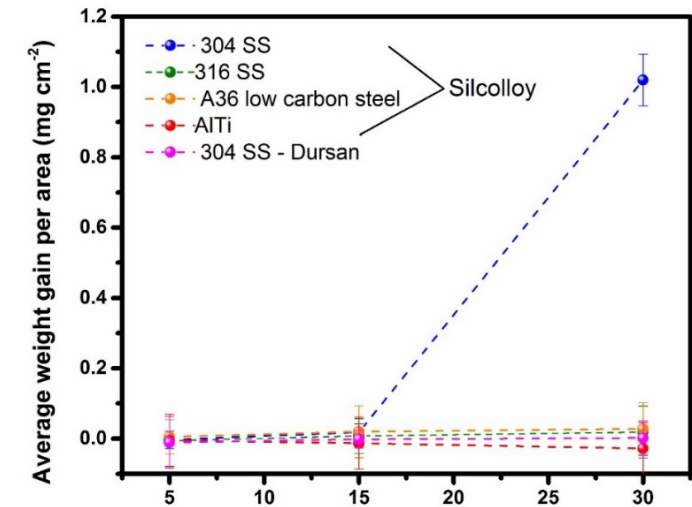

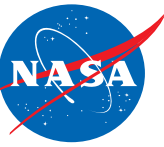

INVESTIGATIONS

Iodine Compatibility of Cathode Materials

Cathode Iodine Compatibility Test Summary

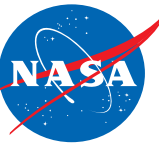

- Performed a series of material investigations with GRC in-house manufacture BaO cathodes assemblies to elucidate why/when BaO based cathode components/operation degrades with iodine.
- Cathode testing supportive of AISP project (1000 hr) and iSAT project (10 hr)

<u>Test #1</u>	<u>Test #2</u>
<ul style="list-style-type: none">• Evaluate Cathode Tube• Orifice Plate• Sheathed Heater & Shield• Held @ 1000 °C by cathode heater	<ul style="list-style-type: none">• Evaluate Cathode Tube• Orifice Plate• Sheathed Heater & Shield• Add BaO based Emitter• Held @ 1000 °C by cathode heater
<u>Test #3</u>	
<ul style="list-style-type: none">• Evaluate Cathode Tube• Orifice Plate• Sheathed Heater & Shield	<ul style="list-style-type: none">• BaO based Emitter• Add Plasma / Current Extraction• Different Cathode Configurations

Cathode Iodine Compatibility Test Setup

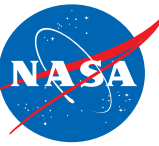

External



Vacuum chamber bulkhead

Hastelloy tubing

Xenon feed for baseline evaluation of cathodes

GRC Vacuum Facility 2 (VF2)

Internal



Heated Feed Line

High sensitivity internally heated MKS pressure sensor (inconel wetted parts)

GRC iodine resistant and heated solenoid valves

~600 g iodine tank

Cathode Assembly

Cathode I₂ Compatibility Test #1

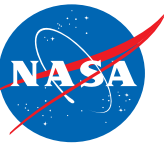

Test #1

- Evaluate Cathode Tube
- Orifice Plate
- Sheathed Heater & Shield
- Held @ 1000 °C by cathode heater



- Test #1 indicated no observable interactions over 24 hour test duration between iodine and cathode orifice or tube.
 - No deposition of iodine compounds observable
 - No material corrosion, cracking or other surface changes observable
- Results were qualitative, but deemed sufficient to proceed with emitter evaluations.
 - Should emitter testing prove positive, quantitative material interactions studies desired with materials group to better anticipate long-term material stability.

Cathode Test #2 (Add BaO Emitter)

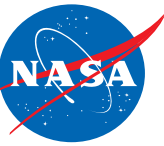

Indicated the BaO insert impregnate reacted with the iodine and resulted in insert degradation (50 hour duration).

- Significant deposition of impregnate material on the downstream surfaces of the cathode.
 - ~50% reduction of effective cathode orifice diameter.
 - Reduced effective gap between cathode and keeper plate.
- Almost complete depletion of impregnate at emitter downstream surface
 - Result is more “difficult” ignition and reduced life.
- Formation of dendritic structure on upstream end of insert was observed.

BaO impregnate demonstrate poor compatibility with iodine.

Before test photo

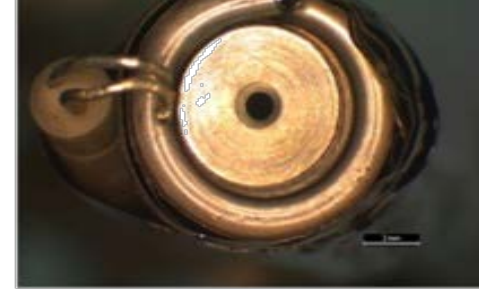

Orifice plate partially clogged and coated



Accumulation of barium and iodine containing compound



Cathode Test #3a→3d (Configuration Changes)

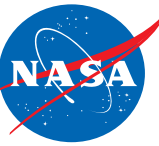

BaO cathode assembly tests with current extraction (Support iSAT)

- Objective to attain a cathode configuration that can operate on iodine within the constraints of the iSAT PPU and meet the iSAT mission requirements.
 - Cumulative operation >8 hours, ignition voltage <600 V, operating voltage <30V.
- **Cathode configuration #3a:**
 - Based on iSAT baseline design.
 - Ignition voltage on xenon 25V, but on iodine >500V and ignition erratic.
 - After iodine exposure, xenon ignition voltage >500V.



BHT-600-I

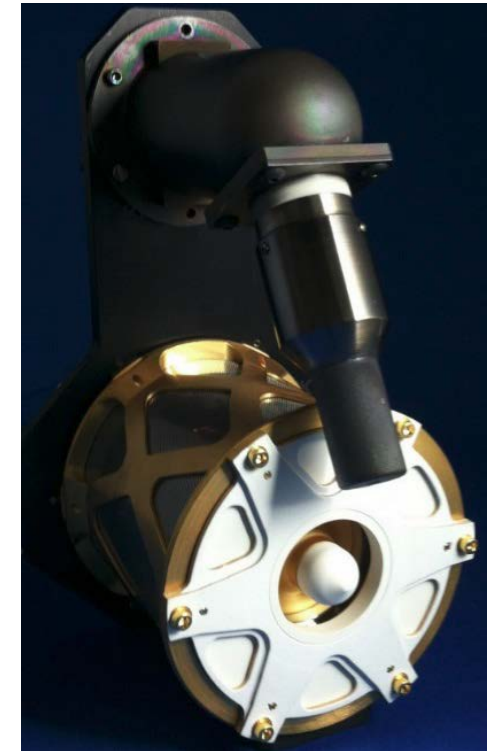

Cathode Test #3a→3d (Configuration Changes)

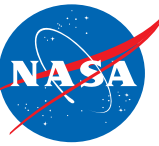

- **Cathode configuration #3b and #3c:**
 - Changes were made to cathode-keeper gap, anode plate, emitter, and test setup.
 - Ignition on xenon ~500V, ignition on iodine ~1000V (4 ignitions achieved).
 - Longest iodine operation 7min, keeper 0.5A, anode 2.0A.
 - Final xenon ignition required ~1200V.
- **Cathode configuration #3d:**
 - New BaO emitter, new keeper tube with additional vent holes
 - Operated ~5 hrs @ 3A on xenon to condition (ignition ~10-50V, nominal)
 - Repeatable iodine keeper ignition (14 ignition cycles) was achieved (250-500V)
 - **Stable discharge operation (current extraction) was not achieved.**

Continued iodine cathode development activities are required.

For the purposes of the long duration iodine durability test, a xenon cathode was implemented.

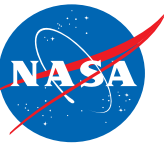

TEST FACILITIES IMPROVEMENTS

Iodine Compatibility of Vacuum Test Facility

Test Facility Iodine Compatibility

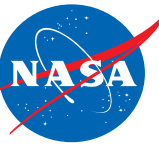

- GRC Vacuum facilities constructed from SS304, thus subject to iodine corrosion.
- Corrosion downstream of plume impingement on wall is evident.
- Natural oxide layer slows corrosion elsewhere, but continuously removed by plume, thus chambers should be lined.
- Low carbon steel is common in facility test equipment such as stages.
 - Bushings corrode
 - Bearings seize
 - Motors fail
 - Test equipment must be custom build with anticipation of iodine.
 - **As such, plume characterization was not able to be performed.**

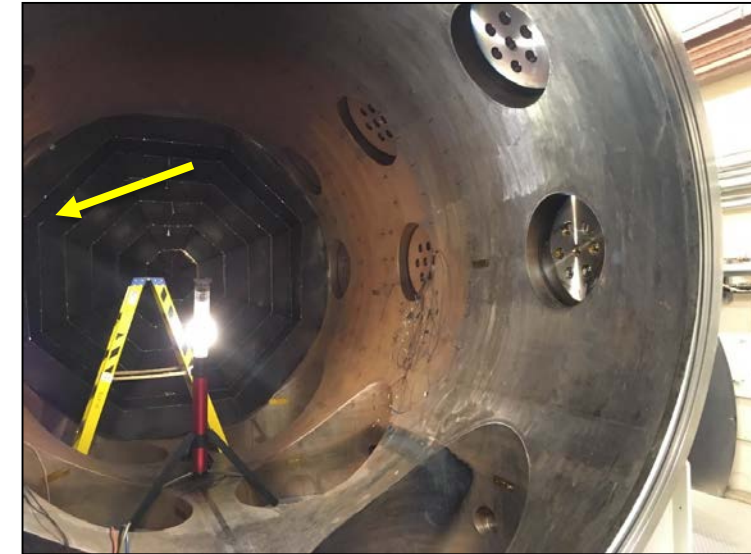

VF7 Corrosion Following Early Iodine Testing

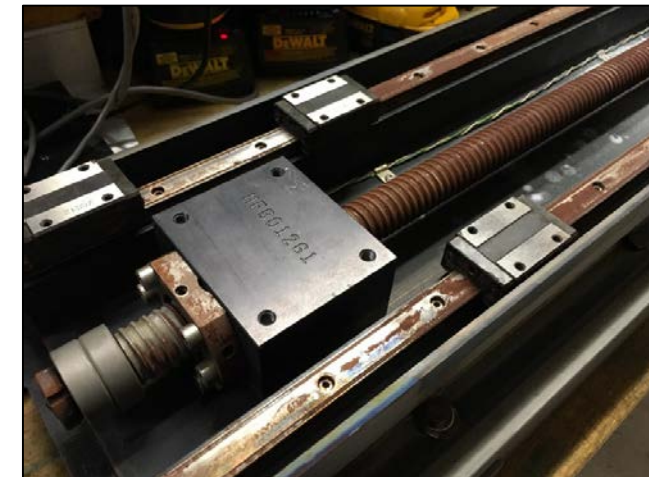

Test Facility Improvements

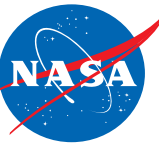

- Chamber lined with graphite in regions exposed to iodine plume.
- Graphite does not chemically react with iodine.

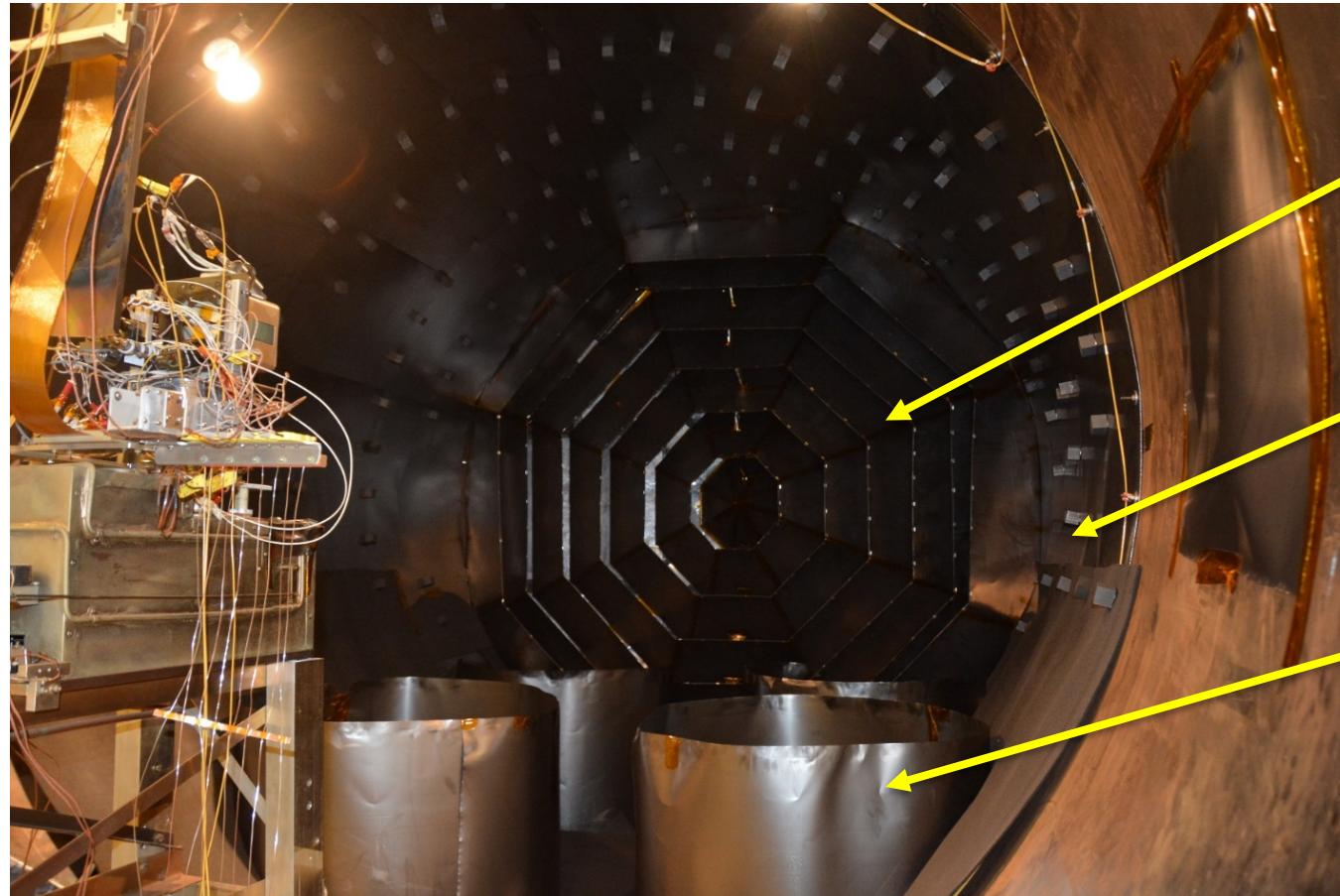

Graphofoil
Covered Aluminum
Target

Graphofoil
Lined Walls

Graphofoil
Smoke Stacks

Test Facility Improvements

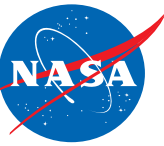

Graphite Felt
(Proved problematic, felt
absorbs iodine, slowed
decontamination post-test)

Future: Recommend
Grafoil or Graphite Plates

Test Facility Improvements

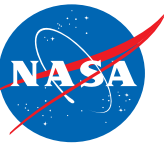

Post-Test Iodine Collection

- During testing, iodine collects on ODP LN2 cooled chevrons.
- How to extract post-test?
 - Short tests → vent to roof through pump
- 1000+ hr test → >10 kg iodine
- Disposable iodine cold trap installed between chamber and Stokes 149 pump
 - PVC Structure
 - LDPE Tubing
- Chilled with 50/50 Glycol/H2O using PolyScience 9712 Chiller
 - Cooled → -20 °C
 - Recover ~90+% iodine
- Future testing could implement a permanent solution where iodine can be recovered.

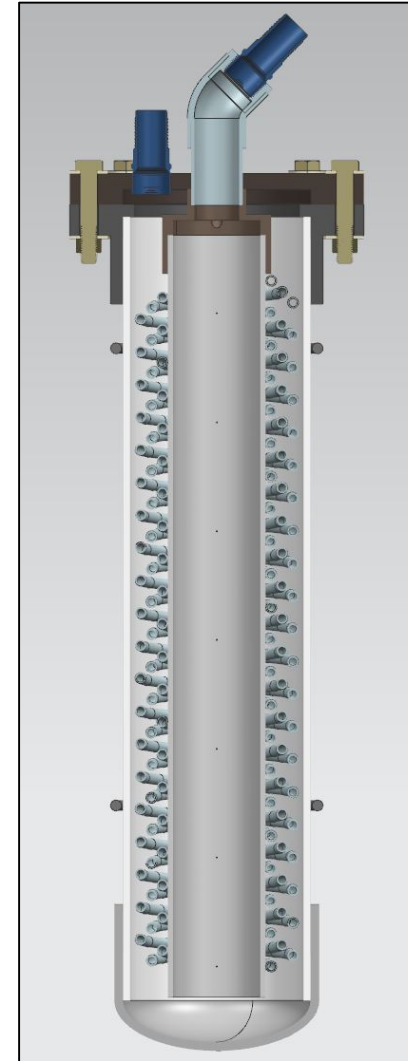



EXPERIMENTAL SETUP

Long Duration Iodine HET Demonstration

AISP IHT Durability Demonstration Test Setup

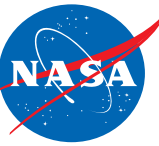

Busek BHT-600-I Hall-effect Thruster

- Busek BHT-600 with material and coating changes to improve iodine compatibility

GRC In-House Heritage Cathode Design

- BaO-CaO-Al₂O₃ impregnated emitter

GRC In-House Iodine Feed System Design

- 10 kg nominal iodine load
- Limited to 5 kg due to lack of availability of loading equipment to melt iodine.
- Reloaded iodine halfway through test.

GRC In-House Iodine Valve Design

- Integral Cartridge Heater

Laboratory Power Supplies

Laboratory Xenon Feed System

All 316 SS Components Coated in Silicon



Durability Demonstration Test Setup

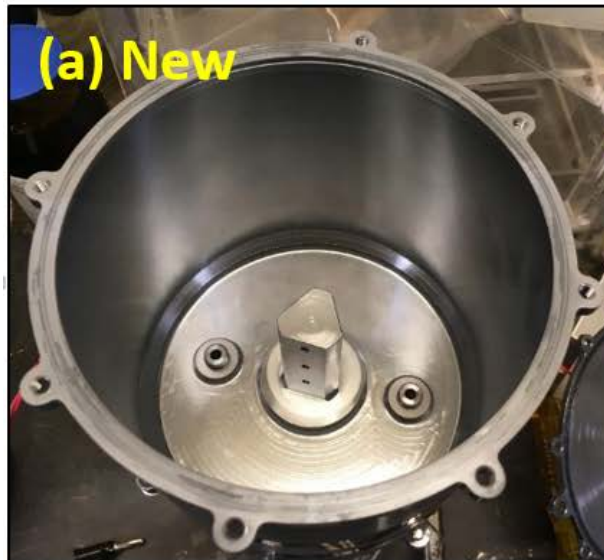
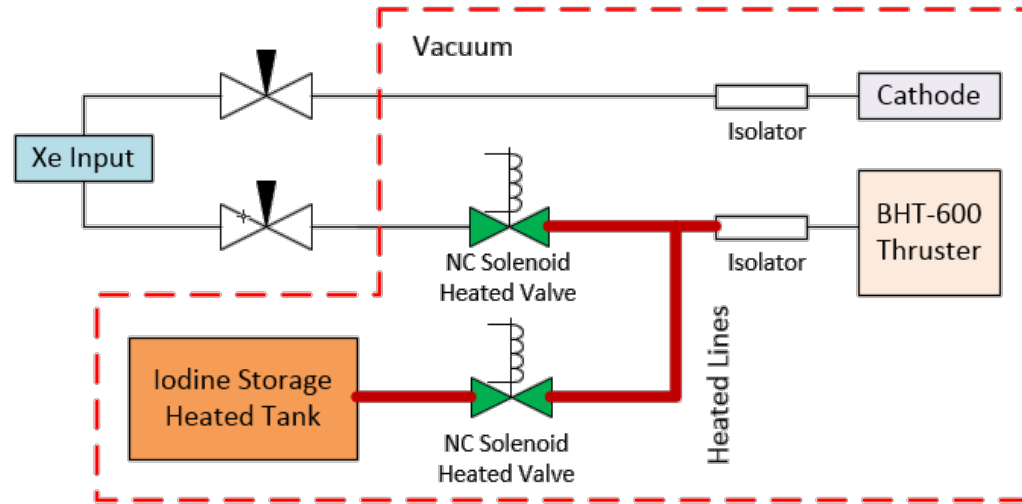
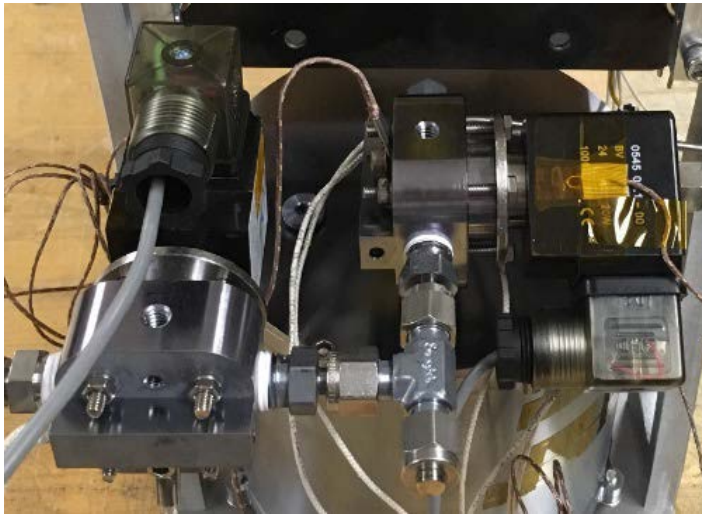
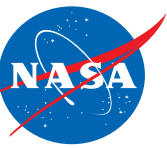

Durability Demonstration Test Setup

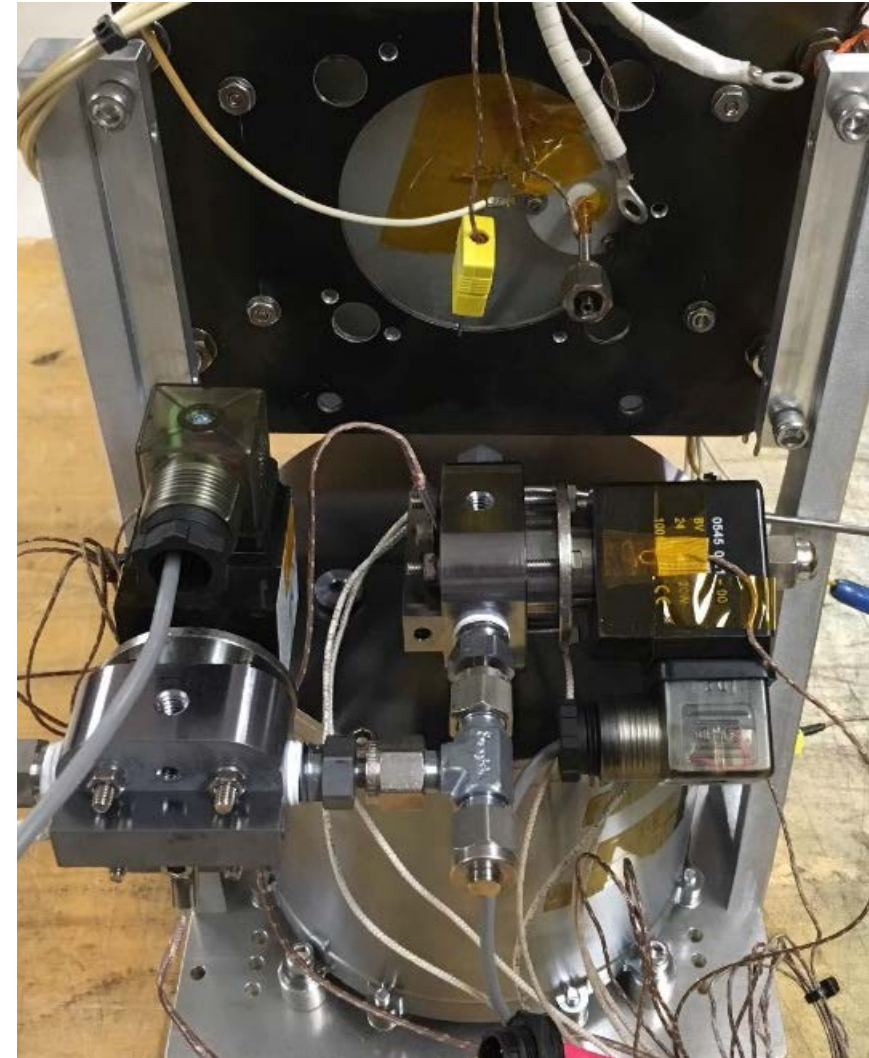
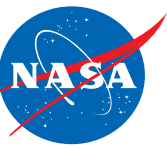

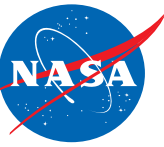

EXPERIMENTAL RESULTS

Long Duration Iodine HET Demonstration

(Iodine-fed discharge, xenon-fed cathode)

1,174-Hour Iodine EP Durability Test

Objective: Demonstrate >1000 Hours Operation with Iodine Propellant

- 29 June - loaded 5 kg iodine (99.99+%), 50% packing fraction.
- 25 July – xenon baseline and iodine EP demonstration initiated.
 - Operated at 300V, 2A (~2.5 mg/s iodine, 0.2 mg/s xenon)
 - BOT Thrust ~41 mN, Isp ~1550 sec
- 18 Aug – iodine exhausted, completed first 576 operational hours.
- 21 Aug – LN2 failure, uncontrolled
- 20 Sept – 5 kg iodine loaded
- 25 Sept – xenon checkout
- 26 Sept – demonstration resumed
- 02 Oct – shutdown, electrical short
- 23 Oct – thruster repaired
- 30 Oct – demonstration resumed
- 18 Nov – demonstration completed

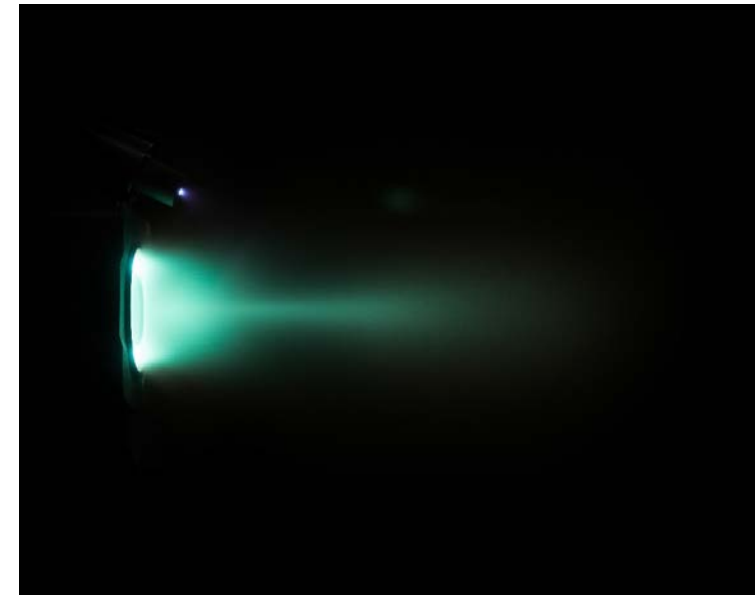

Iodine vs Xe Thrust to Power [mN/kW]

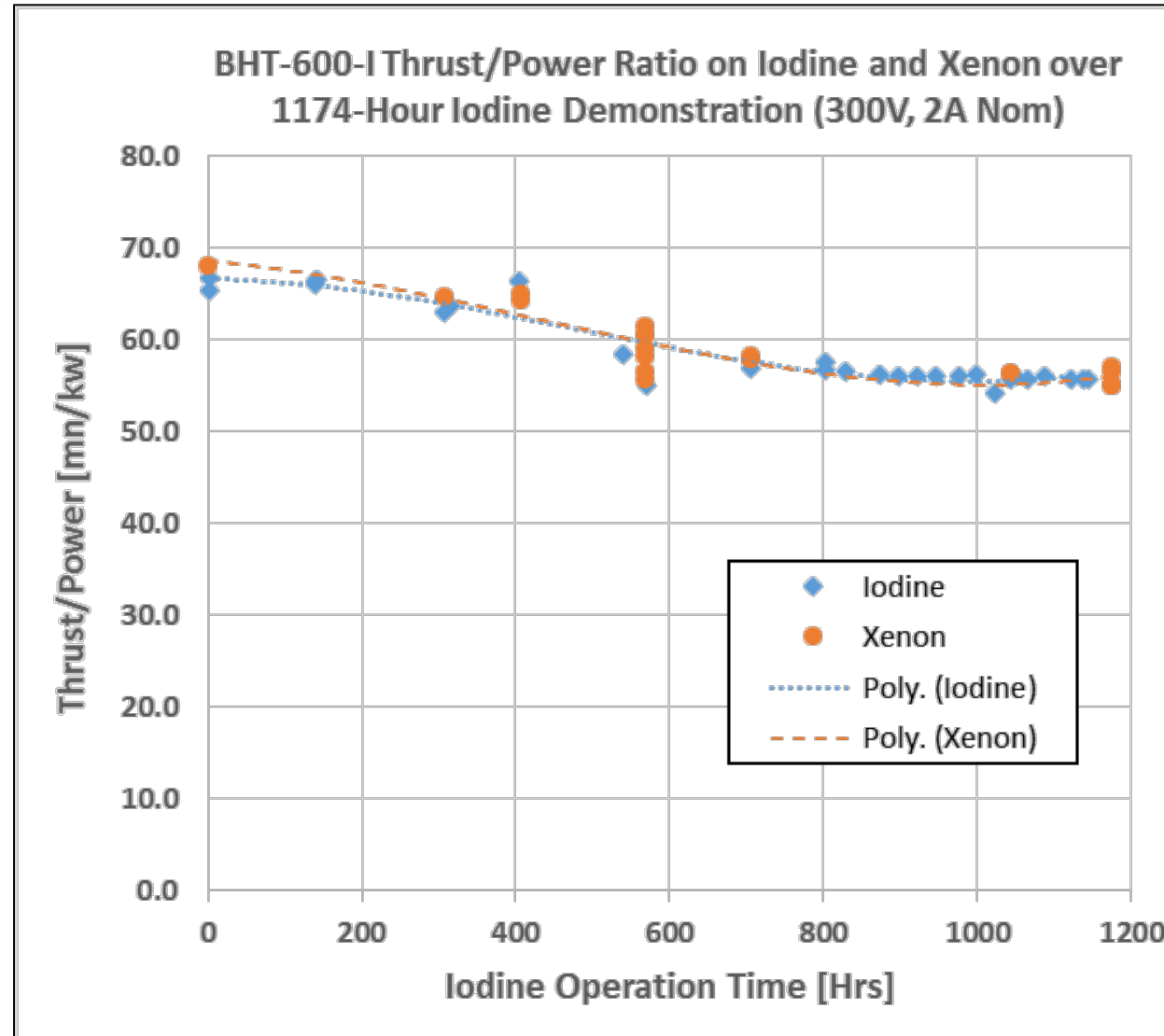
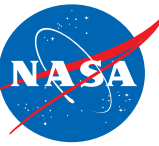

BOT*

Thrust ~41 mN

Isp ~1550 sec

567 hrs*

Thrust ~38 mN

Isp ~1430 sec

EOT*

Thrust ~35 mN

Isp ~1420

*xenon measurements

Failure Investigation at 705 Hrs

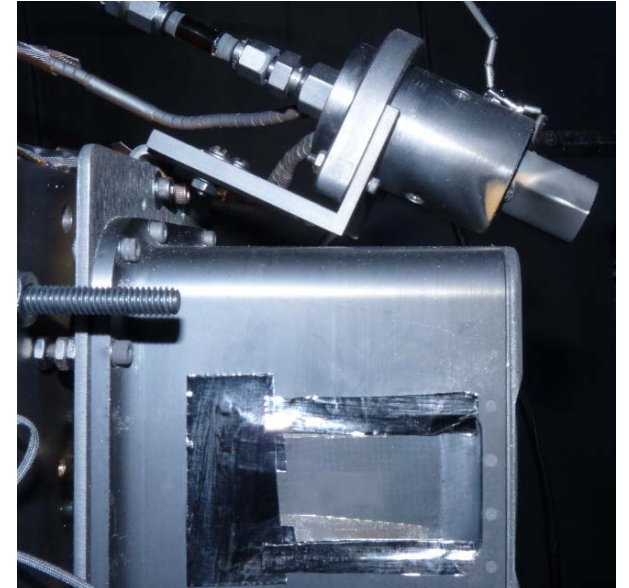

- Corroded ring terminal connecting wire to anode. Replaced ring terminal without removing system from thrust stand. Demonstrates need to be methodical in selection of every component in an iodine system, especially high temperature regions.
- Degradation of body materials at hottest thruster surfaces demonstrates need to carefully consider alloying elements in body materials, not just bulk material.

Power Spectral Density Results - Xenon

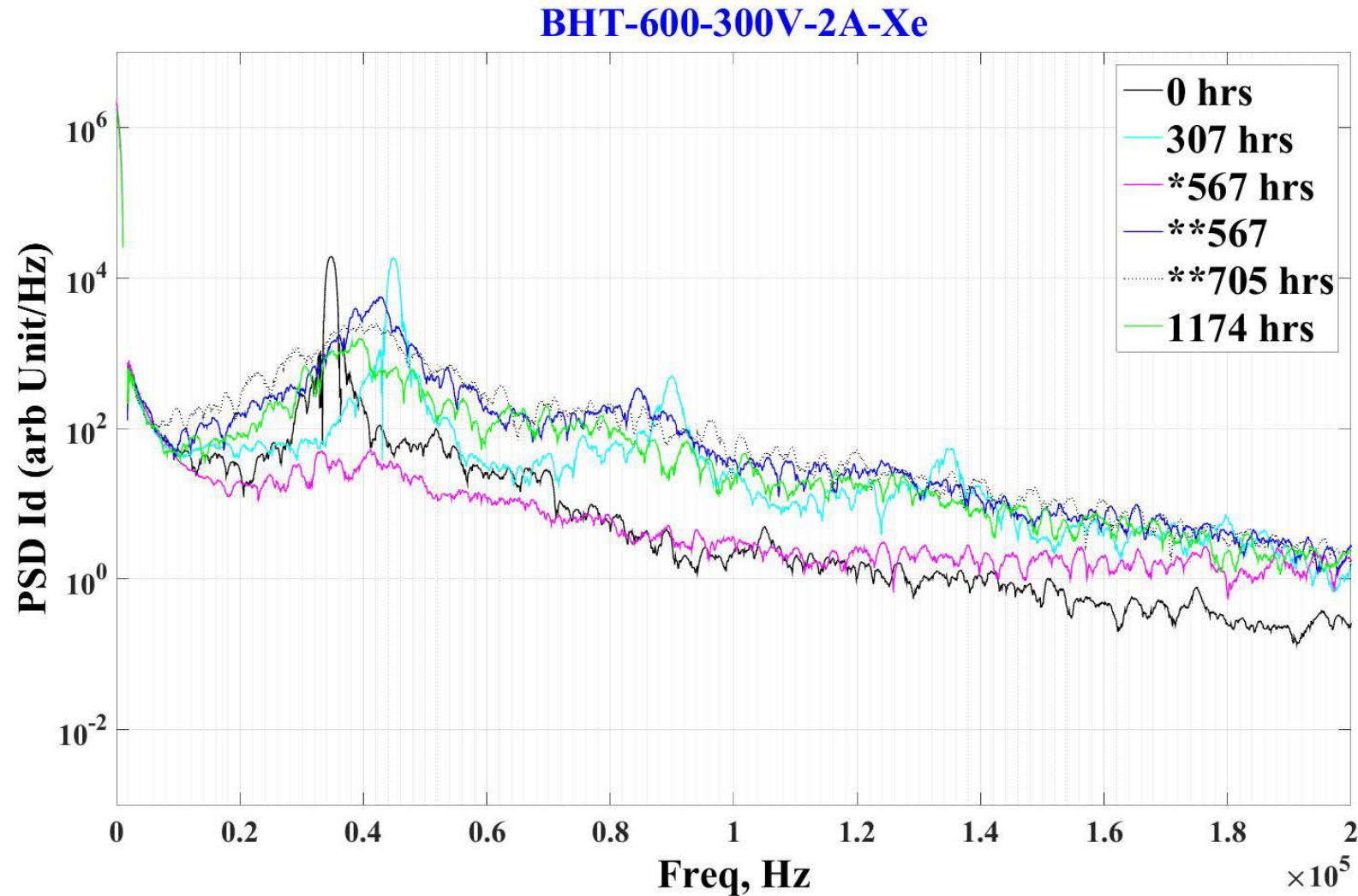
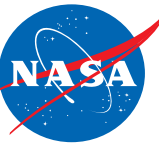

Power Spectral Density Results – Iodine

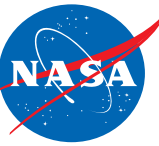

BHT-600-300V-2A-I2

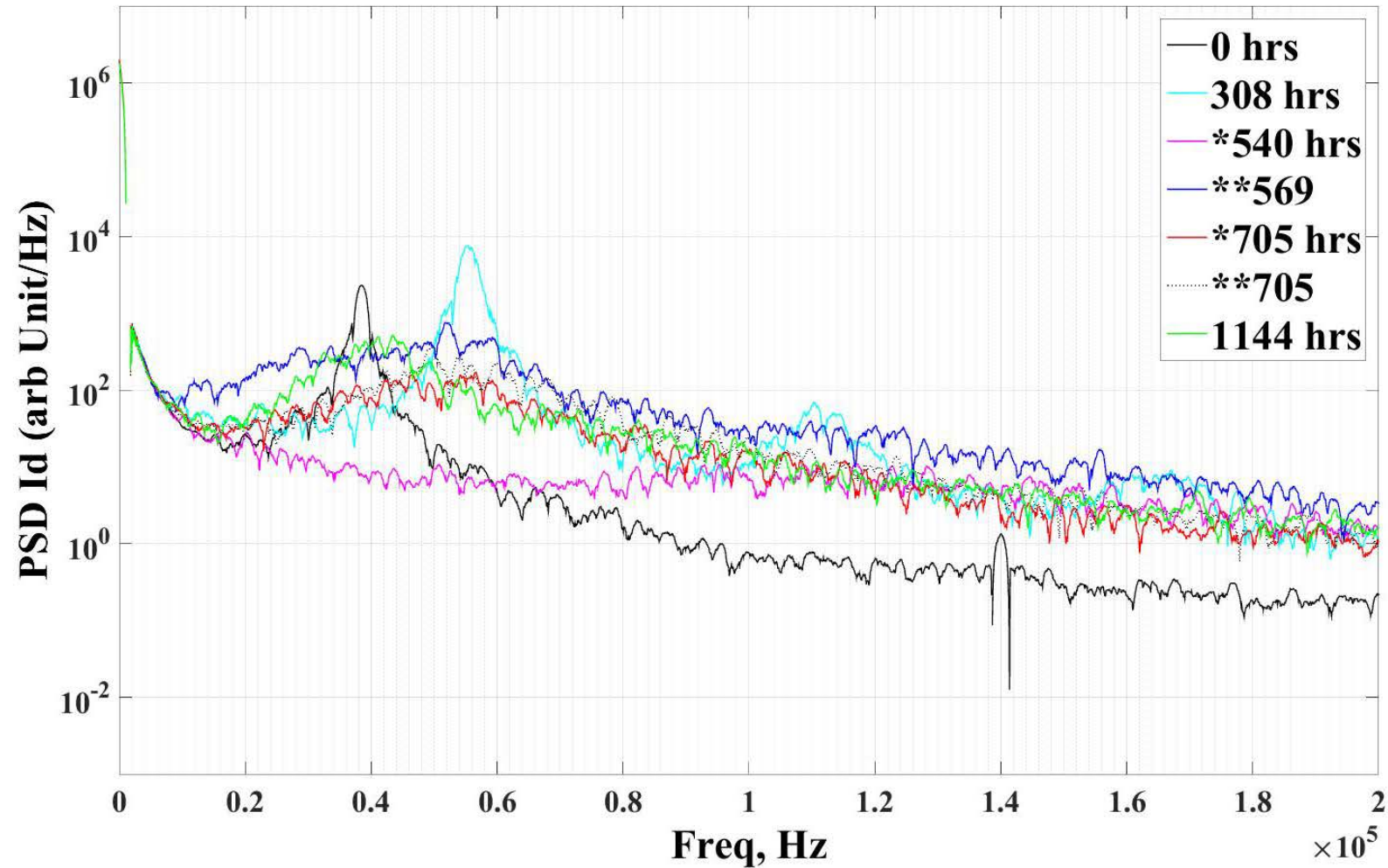

PSDs Comparison Between Xe and I₂



- PSDs show changes in thruster electrical behavior throughout demonstration.
- Iodine and xenon PSDs consistent.
- PSD profiles at 567, 705, and 1174 hours very similar, may indicate that the discharge channel profile has progressed close to its EOL profile.

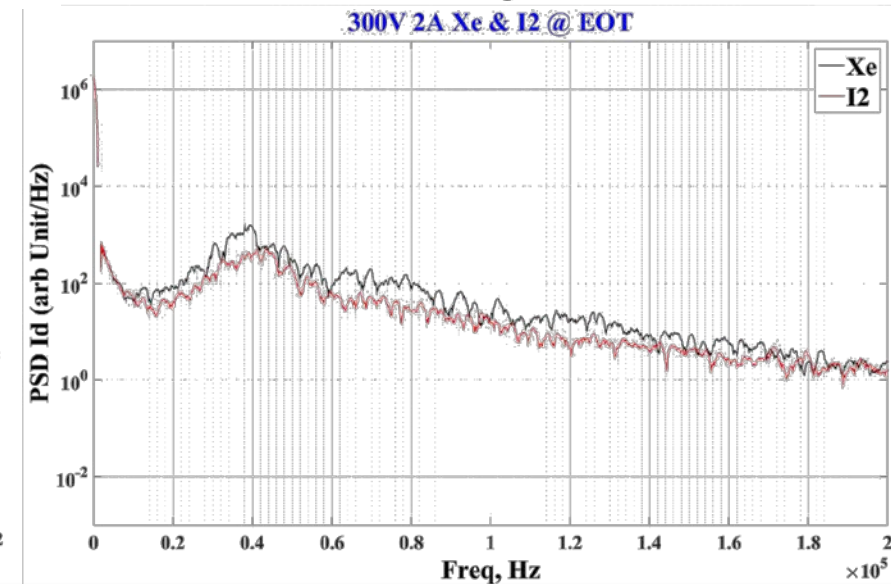
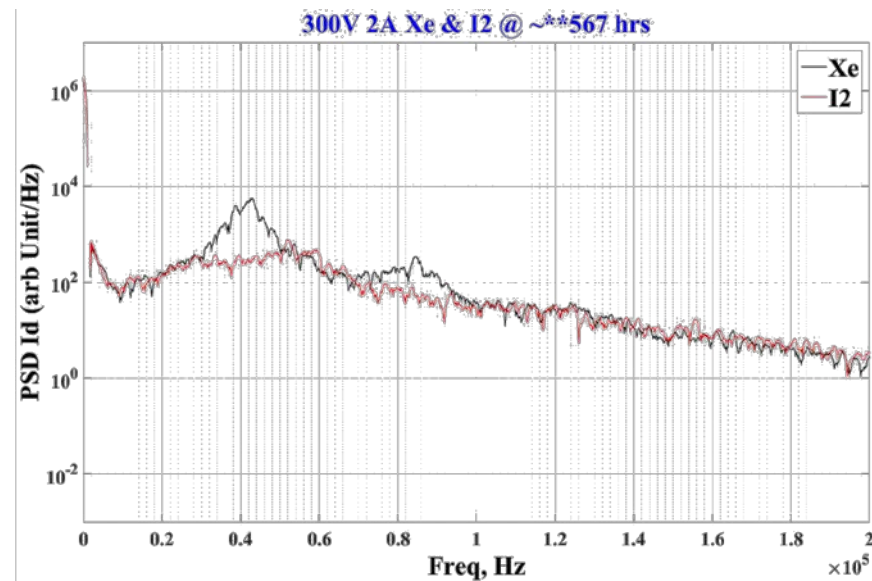
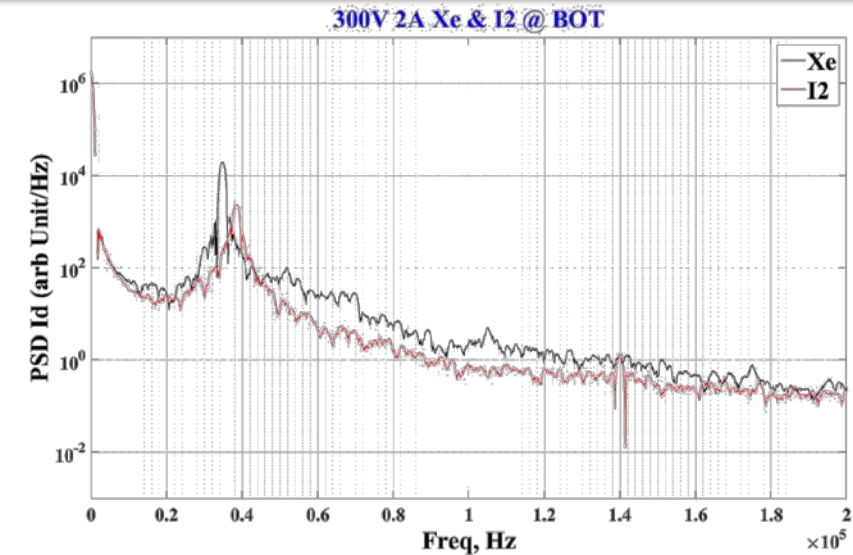

Conclusions

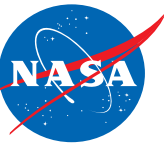

- ✓ Hall-effect thruster (HET) performance is similar between xenon and iodine propellant in all respects GRC has thus far investigated.
- ✓ Implementation of an iodine HET with xenon cathode seems attainable in the near-term for a demonstration mission.
 - Ground demonstration of a long-life all-iodine HET propulsion system may be 10-20 years off due to cathode development challenges.
- Beyond system demonstration, many iodine EP concerns still exist such as S/C interactions, how to acceptance test, etc.
 - Many of these concerns are engineering issues requiring investment, not unsolvable roadblocks.
 - However, deviation from standard practice (i.e. test like you fly) will be necessary to implement iodine, such as acceptance testing prior to flight with xenon, rather than iodine.
- Further investment in iodine resistant facilities is desirable.
- Question: “Given the risks and known challenges, does iodine offer sufficient mission value to justify increased or continued investment?”
 - Further iodine EP mission studies needed to clarify future iodine technology development goals.