

## NASA IceCube: CubeSat Demonstration of a Commercial 883-GHz Cloud Radiometer

Jaime Esper, Dong Wu, Brian Abresch, Brooks Flaherty, Chris Purdy, John Hudeck, Juan Rodriguez, Ted Daisey, Scott Heatwole, Robert Stancil, Thomas Johnson, Alexander Coleman, Negar Ehsan, Kevin Horgan, Jeffrey Piepmeier

NASA Goddard Space Flight Center  
8800 Greenbelt Rd, Greenbelt MD 20771; +1 (301) 286-1124  
Jaime.Esper@nasa.gov

### ABSTRACT

On April 18 2017, NASA Goddard Space Flight Center's IceCube 3U CubeSat was launched by an ATLAS V rocket from Cape Canaveral Air Force Station on board a Cygnus resupply spacecraft, as part of NASA's CubeSat Launch Initiative. Onboard IceCube was an 883 GHz radiometer tuned to detecting ice content in clouds, marking the first time such frequency was used from low-Earth orbit. IceCube successfully demonstrated retrieval of ice water path, *generating the first ever global cloud ice map at 883 GHz*. Its success provides valuable lessons on how to approach a severely resource-limited space mission and provides great insight into how this experience can be applied to future high-risk, "non-class" missions for NASA and others. IceCube marks the first official NASA Earth Science CubeSat technology demonstration mission. The spacecraft was completed in about 2.5 years starting April 2014 through launch provider delivery in December of 2016. The mission was jointly funded by NASA's Earth Science Technology Office, after competitive selection, and by NASA's Earth Science Directorate. IceCube began its technology demonstration mission in June 2017, providing a pathway to advancing the understanding of ice clouds and their role in climate models; quite a tall order for a tiny spacecraft.

### SCIENCE MOTIVATION AND TECHNOLOGY DEMONSTRATION OBJECTIVE

Ice clouds play a key role in Earth's climate system, primarily through regulating atmospheric radiation and interacting with dynamic, energetic, and precipitation processes. Sub-millimeter wave remote sensing offers a unique capability for improving cloud ice measurements from space, due to its great depth of cloud penetration and volumetric sensitivity to cloud ice mass. At around 874 GHz ice cloud scattering produces a larger brightness temperature depression than at lower frequencies, which can be used to retrieve vertically-integrated cloud ice water path (IWP) and ice particle size. This effect was measured with the Compact Scanning Sub-millimeter wave Imaging Radiometer (CoSSIR) airborne instrument developed at NASA's Goddard Space Flight Center (GSFC). CoSSIR was a conical and cross-track imager with six receivers and eleven channels centered at 183, 220, 380, 640 V&H, and 874 GHz. CoSSIR measurements from NASA's ER-2 aircraft showed that the selected channel set was capable of accurately retrieving IWP in a wide dynamic range between  $\sim 10 \text{ g/m}^2$  and  $10,000 \text{ g/m}^2$  after validation against cloud radar and lidar<sup>1</sup>, with large brightness temperature depression centered at around 874 GHz (Figure 1).

The objective of the IceCube project was to retire risks associated with development of 874-GHz commercial

receiver technology for future Earth and space remote sensing instruments, by raising its Technology Readiness Level (TRL) from 5 to 7.

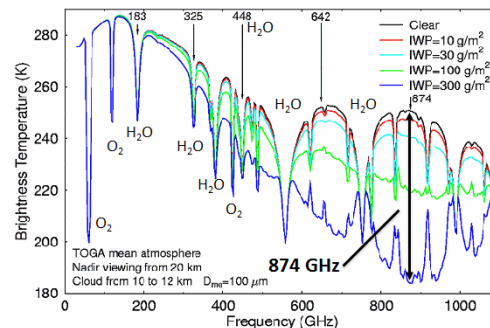

**Figure 1: CoSSIR measurements of ice clouds were used to successfully demonstrate retrieval of ice water path (IWP) and ice particle median mass-weighted ice particle size ( $D_{me}$ ). The 874 GHz data proved to have the greatest sensitivity to ice.**

### Status

IceCube entered its commissioning phase upon release from a NanoRacks dispenser onboard the International Space Station on 16 May 2017, and began its technology demonstration mission about a month later. The spacecraft continues to operate as of this date, although the primary mission was only slated to last for

one month. It continues to provide valuable data on technology performance and global ice cloud content.

The project has successfully demonstrated, on a 3U CubeSat in a Low-Earth Orbit (LEO) environment, a commercial receiver's performance with a calibration uncertainty of  $\sim 3K$ . The mission not only demonstrated the radiometric technology, but as a bonus has also *generated the first ever global cloud ice map at 883 GHz*. The receiver technology used was initially developed by Virginia Diodes Inc. (VDI), under NASA's SBIR Phase II program. The center frequency was optimized for this receiver at 883 GHz (with the lower sideband at 874 GHz).

In what follows, we summarize the as-built system, the lessons learned during integration and test, what was learned during operations, and finally provide a preview of science results. IceCube's miniature instrument is expected to provide a pathway to advance the understanding of ice clouds and their role in climate models.

### RADIOMETER INSTRUMENT OVERVIEW

Key performance parameters of the IceCube radiometer are shown in Table 1. The Radio Frequency (RF) receiver is comprised of an offset parabola reflector with feedhorn, mixer, stable oscillator, RF multiplier chain, Intermediate Frequency (IF) chain, video amplifier, and detector. There are also supporting circuit boards including the instrument Power Distribution Unit (iPDU) and Command and Data Handling (C&DH), which is shared with the spacecraft. The radiometer has a noise figure of 15 dB with a Noise Equivalent Differential Temperature (NEDT) of 0.15 K for a 1-second dwell time. The instrument is both externally and internally calibrated using views of deep space and an internal IF noise source and reference state.

**Table 1: Key IceCube Radiometer Parameters**

Category	Value
Frequency Band	862-886 GHz with $f_c$ at 883 GHz
Input RF Channel	V Polarization
NEDT	0.15 K
Calibration Sources	Noise Diode/Reference Load (internal)
IF Band	6-12 GHz
IF Gain	50-55 dB
A/D Sampling	10 KHz
Integration Time	1 second
Mass	$\sim 1$ kg
Power	$\sim 6$ Watts

The instrument is shown in Figure 2, and a simplified block diagram is shown in Figure 3. The radiometer front-end is comprised of an 883 GHz local oscillator (LO). Intermediate frequency (6-12 GHz) calibration by noise injection provides the means of discriminating the calibration state of front-end components, referenced to extended observations of space. The RF input to the mixer is a GSFC-designed antenna, which is a straightforward  $\sim 2$  cm offset-fed paraboloid yielding a 1.7-degree half-power beam-width. At nadir, the main beam covers a  $\sim 10$  km 3-dB footprint from a 400 km satellite orbit altitude. With a ground track velocity of approximately 7 km/sec, a 1-second output sampling period provides 0.7 to 1.4 times Nyquist sampling rate of the antenna main beam.

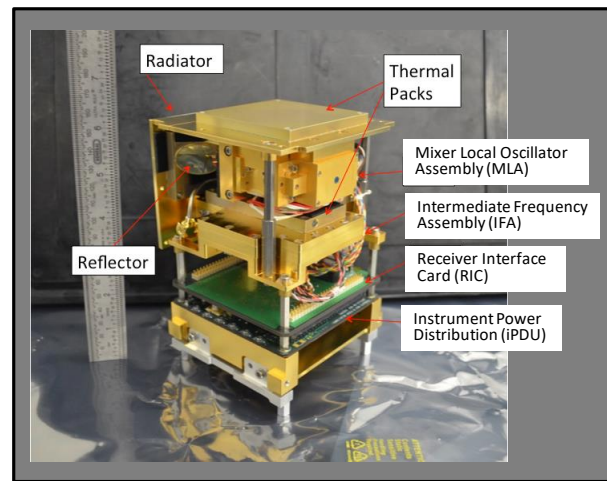

**Figure 2: IceCube Miniature Radiometer**

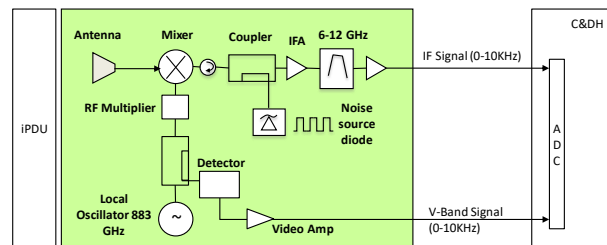

**Figure 3: Simplified radiometer block diagram**

Calibration of the radiometer is achieved by both internal electronic and external natural target means. Externally, the primary target is space, which is viewable by pointing the antenna beam above the Earth's limb and provides the absolute offset of the system. Internal calibration of the receiver is carried out by the IF stage, which is used during and between external views of space. The noise source coupled into the IF path is used to estimate IF section gain. An illustration of the vehicle observations over an orbit is shown in Fig. 4.



**Figure 4: Typical operations over one orbit, with alternate Earth/space views for calibration**

### SPACECRAFT OVERVIEW AND SUBSYSTEM LESSONS

The instrument was accommodated in a 3U CubeSat, following the general volume and mass guidelines of the CubeSat specification standards (CubeSat Design Specification Rev. 12, Cal Poly SLO). Ultimately requirements levied by the NanoRacks Dispenser used to deploy the vehicle from the International Space Station (ISS) were used (NR-SRD-029 Rev. 0.36 and NR-SRD-052 Rev. 0.1). This allowed for slightly more mass (maximum 4.8 kg instead of 4.0 kg). The spacecraft layout is shown in Figure 5, and the mass and volume allocations are shown in Table 2.

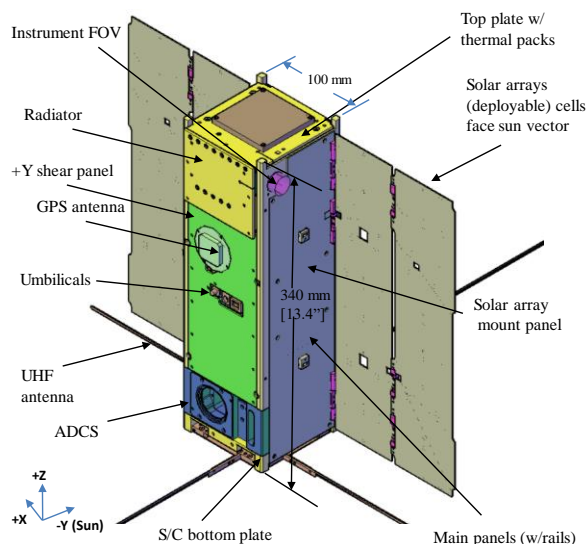

**Figure 5: IceCube 3U spacecraft layout**

The original idea was to use Commercial-Off-The-Shelf (COTS) components with proven flight heritage, but that proposition was not quite as valid once electrical

incompatibilities were discovered, even within components provided by the same vendor. Only one bus system card was to be custom manufactured at GSFC, and was necessary to provide data interface to the instrument and other bus components. The resulting high-level block diagram is shown in Figure 6.

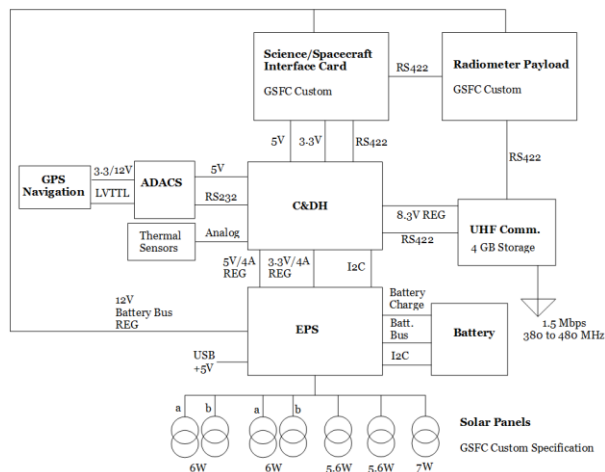

**Figure 6: Simplified Block Diagram with GSFC In-House Radiometer and Science Interface Card**

**Table 2: IceCube mass and volume allocations**

Component	Mass (kg)	Volume (U)*
Payload	0.8	1.3
Structure and Mechanisms	0.9	1.7
RF Communications	0.2	
Electrical Power	1.4	
Guidance, Navigation, and Control	0.9	
Command and Data Handling	0.2	
Thermal Control	0.1	
<b>Total</b>	<b>4.5</b>	<b>3</b>

\* 1U = 10x10x10 cm Cube, with a mass < 1.33 kg

Following is a more detailed description of each spacecraft subsystem, with an emphasis on highlighting issues discovered during their respective Integration and Test (I&T). With this the authors hope to convey some of the pitfalls inherent to components intended for general use, i.e., “COTS”, that may or may not meet specific safety, reliability, or interface requirements. Care should be exercised in ensuring all documentation is provided prior to purchase, and that it is clearly written so as to avoid any miss-understandings during I&T and operations. With NASA testing practices in mind, care should also be exercised not to “over-test” a component that is intended for single or limited use (more on that later). Finally, any known modification

expected of a COTS component immediately renders such component inoperable as a true “COTS” part, and both schedule and budget should be planned accordingly to account for the necessary modifications and accompanying non-recurring engineering that must take place. After all, a quote that states we “shall deliver modifications as required” will not account for the extra expense the project can and will incur when those modifications are not delivered on-time, even if the vendor’s price for the part remains fixed.

### Structure and Mechanisms

The primary structure of the spacecraft is comprised of custom machined aluminum walls, cross plates, and closeout panels. The bus electronics stack uses a threaded rod and spacer combination to tie the various printed circuit boards together. Interface brackets are used to join the science payload to the spacecraft bus. Mechanisms include two double deployable solar arrays and a deployable Ultra-High Frequency (UHF) antenna with two elements. Detailed assembly procedures helped guide the integration process and the system went together mechanically without any significant issues.

During testing, issues were encountered with the deployable solar arrays and separation switches. For the solar arrays, the rate of deployment was impacted by hinge misalignment which was directly related to alignment of the interfacing surfaces. Shimming techniques were used to improve deployment performance. Issues were also addressed relative to the solar array burn wire release system. The resistors used to initiate the release had a shorter life than anticipated and required replacement. Post replacement, extra care had to be taken throughout the remainder of testing to preserve their integrity.

Separation switch issues were related to tolerances and switch failure. Upon initial fitting into the dispenser, the switches did not engage properly with the dispenser rail. Since the design did not allow for switch position adjustment, the switch levers were slightly deformed to obtain the necessary engagement. Post vibration, one of the three switches failed and required replacement. New switches were workmanship tested and the faulty switch was replaced. This, coupled with the discovery of debris inside the dispenser from IceCube’s staking adhesive, required spacecraft disassembly and resulted in additional vibration testing to demonstrate launch vehicle compliance.

In hindsight, IceCube roller-type mechanical separation switches should have *all* undergone workmanship (vibration) testing prior to integration into the spacecraft due to their inherent unreliability and

criticality: any *one* (out of three) switch failures could have prevented the spacecraft from powering-up resulting in mission failure. Alternative approaches to the ISS (or launch vehicle) 3-inhibit requirement using *mechanical switches* should be considered a high-priority in the CubeSat community. At the very least, use of sealed switches is a must to prevent debris or external contaminants from entering and jamming the mechanism.

### Thermal Design

IceCube implements a passive thermal control system (except for heaters). The instrument is power-cycled to keep it from running too warm, and the spacecraft makes use of operational heaters on the battery pack, since it has the tightest temperature limits of all components. The spacecraft has two thermal control zones: the first zone consists of the bus plus the instrument electronics, and the second zone consists of the Mixer LO Assembly (MLA) / Intermediate Frequency Assembly (IFA) part of the instrument. The MLA/IFA zone is isolated from the rest of the spacecraft with the use of ULTEM™ spacers and low emissivity coatings such as iridite and gold plating. The MLA/IFA components are thermally coupled to dedicated radiators that use a tailorably emittance coating to reject heat to space. The spacecraft uses the +Y panel coated with Composite Coating Silver (CCAg), and the uncoated solar array mounting panels as radiators. Figure 7 shows the radiator locations.

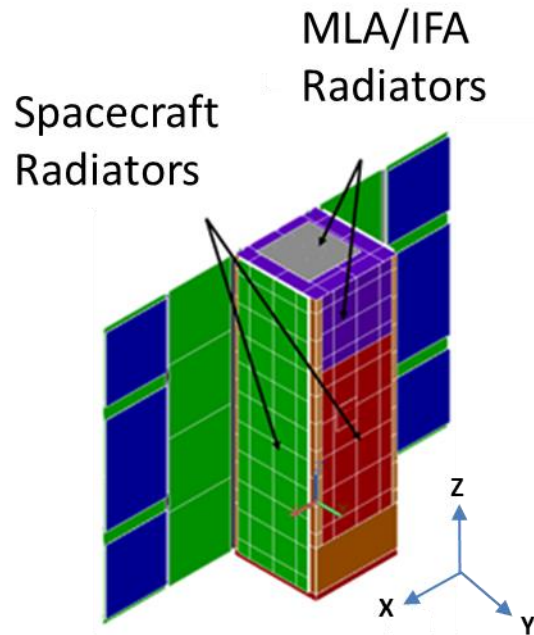

Figure 7: Radiator Locations



For optimal science performance, the temperature of the instrument needs to remain below 30°C. The instrument was designed to be power-cycled operationally in order to keep it within its desired temperature range, and because of reliability concerns with the COTS battery (maintaining a sufficiently low depth of discharge). The design implements the use of Phase Change Material (PCM) in order to dampen the transient temperature response, with the initial goal of maintaining a stability of 20°C ±1°C. Although this tight control was not met, as the mass of the system was ultimately too low to finely control the transient response when going from day to night, it did help dampen the temperature response. The PCMs were installed with indium as the interface material in order to improve heat transfer. Two methods were implemented to control the duty cycle of the instrument. Simply, the first was to turn on the instrument during the day portion of the orbit and to turn it off during the night portion of the orbit. The second was to turn on when the instrument dropped below a temperature threshold (16°C), and to turn off when it went above a temperature threshold (initially 25°C, later changed to 30°C). Both control methods were used in flight, and both worked well and kept the instrument running between 16°C and 29°C, which yielded satisfactory science.

The spacecraft electronics boards use a threaded rod and aluminum spacer combination for mounting. Although this simplifies mechanical integration, it makes for a less efficient heat transfer path from the boards to the cold radiator. Nonetheless, this proved sufficient to meet requirements during worst case thermal conditions. A more robust alternative from the thermal point of view would have required the use of card locks to directly mount the edge of each board to the aluminum walls of the spacecraft. The L3 Cadet radio was mounted with a coat of Nusil to improve heat transfer during transmission periods, since the radio has the highest thermal dissipation of all components, at around 10 W. The solar array wings are mounted to the sides of the spacecraft and double as side closeout panels. Nusil is also used as the thermal interface material to couple the side panels to the rest of the spacecraft structure and serve as effective radiators (Figure 7).

### Electrical Systems

The electrical system on IceCube consists of power, C&DH, communications, and attitude control subsystems. All spacecraft bus sub-system components are COTS with the exception of the Science Interface Card (SIC), which is a GSFC-designed card that provides level translation, analog-to-digital conversion for the instrument health sensors, and an interface to the

instrument radiometer digital counts. Figure 8 shows the general layout of the electrical system components. More specific detail of each sub-system will be provided in subsequent sections.

The SIC, Pumpkin flight computer, and Clyde Space Electrical Power Subsystem (EPS) and battery are all mated via the CubeSat Kit Bus 100-pin header interface for passing nonregulated and regulated voltages, as well as data and clock signals. Due to some inconsistent bus pin use with the COTS components discovered during detailed ICD document review, some pins had to be removed to avoid routing a voltage source from one card to a signal on another card. A custom interface harness was constructed to mate to the Cubesat Kit Bus interface to allow power and data connection to the Cadet-U, GPS receiver, Blue Canyon Technologies (BCT) XACT (Attitude Determination & Control System Technology) ACS unit, and UHF antenna. Additional connections requiring custom cables include those between the SIC and the instrument components, solar panels and battery, and power inhibits and battery.

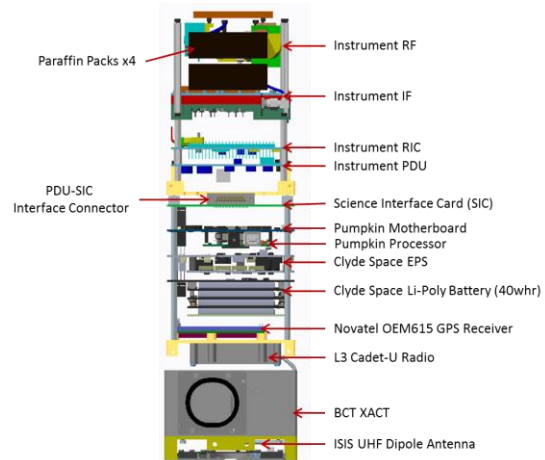

**Figure 8: General IceCube Component Layout Showing the Individual Electrical System Components**

Three mechanical switches (deployment switches) with connection to the battery were mounted to the longitudinal rail of the spacecraft, such that when installed in the deployer, the switches would be closed and prevent power delivery from the battery to the spacecraft components (referred to as power inhibits). An external umbilical interface was accommodated in the mechanical layout to be used during I&T and ground testing. The umbilical interface allowed access to the release switch (deployment switch) inputs by bypassing the mechanical switches. The interface also provided external spacecraft power input and battery charge, a data interface to the flight computer, as well as coaxial disconnects for the GPS and UHF links

which allowed for bypass of the antennas to provide direct access to the GPS receiver and Cadet-U.

### Electrical Power Subsystem (EPS)

The IceCube power subsystem consists of two 3U double deployable solar arrays and a 2U body-mounted array for power generation. A 40 Wh battery is used during eclipse operations. The electrical power subsystem is responsible for performing required voltage conversions, charging the batteries, completing power switching activities, and health monitoring for anomaly discovery and diagnosis. Eclipses last 37 minutes maximum out of a 93 minute orbit. The 1U communications antenna has a built-in solar panel which does not regularly see the sun and is not normally required, except for detecting the sun during a contingency. The battery charge regulators of the EPS condition the power generated from the arrays into suitable levels for battery charge and subsystem feed.

A summary of IceCube power consumption per subsystem is shown in Table 3. During data downlink times the science instrument is switched off, and the transmitter is switched on for about 9 minutes (max.).

**Table 3: IceCube Power**

Subsystem	Component	Power (W)
Instrument	Power distribution, Interface Card, Instrument	6
GNC/C&DH	GPS	1.2
	LNA	0.1
	ADACS	3.3
	Processor Board	0.1
RF Comm.	Transmitter	12.0
	Receiver	0.04
	Antenna	0.02
Power	EPS	0.4
	Battery Board	0.1
Thermal	Battery Heater	0.8
<b>Total</b>		<b>24.0</b>

For an orbit period of about 1.55 hours and eclipse of 0.62 hours, the battery stored energy requirement is about 15 Wh. Hence a 40 Wh. battery provides more than twice the needed capacity. On the other hand, the solar panel was required to provide at least 24 W of power at End-of-Life (EOL). The solar panels yielded 30 W at Beginning-of-Life (BOL), which provided more than enough power to account for degradation effects.

There have been no in-flight anomalies, with the exception of a battery thermistor yielding erroneous

temperature data during hot beta conditions. Whereas the daytime battery voltage is normally ~ 8.3V, the lowest battery voltage during night-time science operation (instrument on) is ~ 7.7V, corresponding to a 35% depth of discharge. The battery flight software threshold at which instrument is turned off is set to 7.5V. Figure 9 shows a typical on-orbit voltage profile.

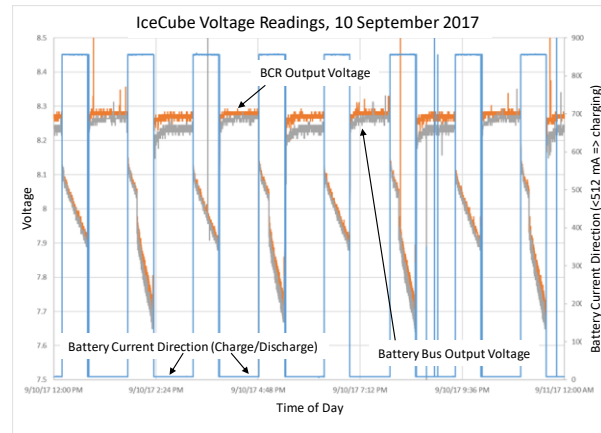

**Figure 9: IceCube On-Orbit Voltage Readings (BCR: Battery Charge Regulator)**

The following points can be made concerning IceCube’s power system implementation:

1. Verification of electrical compatibility of COTS components can be a tricky proposition, which may preclude long-lead purchases until the interfaces and operation are well understood. To complicate the situation, existing public documentation is vague enough that becomes insufficient in determining electrical compatibility until the units are in-hand. Effort should be spent in asking for clarification of COTS documentation and understanding the system operation prior to purchase in order to avoid later delays.
2. There was a need to update the COTS component to make it compatible with ISS safety standards. This caused project delays.
3. The EPS had to be modified to be compatible with the same vendor solar panel deployment circuitry: individual switch current capability was insufficient for dual-wing deployments. Switch current limits had to be increased to allow for redundancy. This turned out to be critical, as it was the redundant circuit what ultimately deployed the panels (more on this later).
4. Long-lead times must be accounted for even in “no-class” projects. The need for ample time to order is in juxtaposition to the somewhat vague details available in commercial component documentation. This “catch-22”

situation can be ameliorated by demanding detailed vendor documentation during Phase-A in order to understand the idiosyncrasies of each component and of course, by simply requiring better specifications once a purchase decision has been made. This issue resulted in several-month schedule delays for IceCube.

5. Limited funding meant that Engineering Test Units (ETU) were not always available, which fed into delayed discovery of interface and compatibility problems. This risk is hard to overcome in resource-strapped projects. The gamble is that it will all come together in place, which rarely works. At the very least, schedule and budget reserves should be held to account for problems that may be discovered during flight unit integration, if ETU's are not used.

### Custom-Made Solar Panels

GSFC specified the solar arrays to ensure active solar cells existed on the outer side of stowed panels, allowing for battery charge and spacecraft operation during contingency. In addition, attitude control and science operations favored CubeSat “square-facing” arrays (as opposed to edge-deployed). Clyde Space was tasked with modifying its double-deployed 3U COTS panels to accommodate this requirement. Although this was a safety feature built-in the original spacecraft design (also providing ~ 0.8 W of extra power from Earthshine when deployed), it proved to be a challenge both technically and programmatically. The severe envelope constraints within the CubeSat dispenser required double-folded panels to be thin, yet capable of supporting solar cells on both sides of the outer wing. It also required modification of the deployment hinges. Design modifications took at least a couple of iterations to test out and perfect (at the manufacturer’s site), with ensuing schedule delays and corresponding increases in cost. Although this was a tough proposition, in the end the resulting panels prove quite capable for 3U CubeSats going forward. Figure 10 shows the specified arrays, and the resulting flight units.

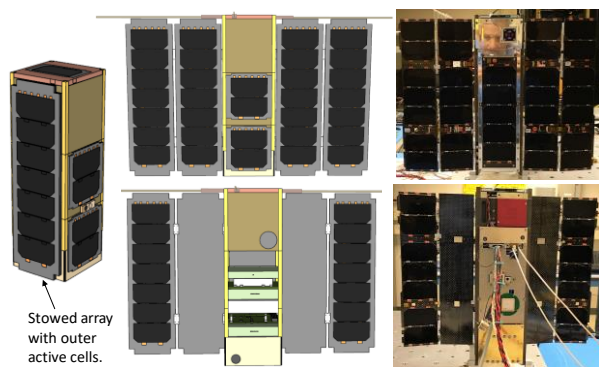

**Figure 10: Specified (left) and As-Built Solar Panels**

### Guidance, Navigation, and Control (GNC)

The IceCube GNC system consists of a XACT Attitude Determination and Control Subsystem (ADCS), and a Novatel OEM615 GPS receiver for position and velocity determination. The XACT is a 0.5U ACS consisting of a Star Tracker (ST), two axis Sun sensor, MEMS Inertial Measurement Unit (IMU), 3 reaction wheels, 3 magnetic torquer rods and a processor for control. For IceCube, attitude control is not as difficult to achieve as attitude knowledge. The attitude *control* requirement is driven by the need to hold the solar panels to the sun within 5°, and to spin about the sun line at 1°/s for instrument calibration. Attitude *knowledge* on the other hand is driven by the need to determine the location of the instrument Field-of-View (FOV) to within 25 km on the ground. To that end, the GNC system needs to have sufficient pointing knowledge of the instrument aperture (spacecraft *attitude*) and sufficient knowledge of the spacecraft *position* (altitude and location). In combination with other factors and errors the attitude must then be *known* to ~ 0.4°, which requires the use of the ST.

The ACS has two functionally similar modes, using two different set of sensor inputs: a safe mode called Sun Point Mode (SPM) which consists of pointing the solar panels to the sun and rotating about the sun vector at 1°/s *during the day*, and similarly, a Fine Reference Mode (FRM) which consists of pointing the solar panels to the sun and rotating about the sun vector at 1.2°/s degree per second *day and night*. The difference between SPM and FRM is that SPM uses the two axis sun sensor for control during the day *spinning about the Y axis*, and otherwise during nighttime *spins about the Z axis* at ~1.5 degrees per second, *with the Z-axis aligned along the magnetic field lines*. FRM on the other hand uses the estimated attitude from the IMU and ST to spin about the sun line and *maintains its orientation in eclipse*.

The ACS has operated well from the beginning and has met science needs. The only area of concern has been with the GPS. The GPS receiver has been power-cycled twice due to Single-Event Upsets (SEU), generally when entering the South Atlantic anomaly (SAA). Another issue has had to do with erroneous packets (noise) coming from the GPS receiver, which causes the XACT orbit ephemeris to be invalid. This in turn causes the orbit propagator to lock-up and malfunction, to the point where the XACT automatically exits FRM mode, nominally an hour later after the event. This problem has made it hard to keep the ACS in FRM mode for more than a day or two. After some trouble-shooting, BCT provided a software fix that would essentially filter the GPS noisy data, but this fix required commands that had not been

implemented in flight software (in order to save time and cost on software testing), so the XACT continues to exhibit the same problem. Ultimately, the science team determined that spinning faster about the magnetic field line in eclipse was actually useful from a science perspective and decided to stay in SPM rather than transitioning back and forth. In hindsight, a more complete XACT command set capability, rather than the bare minimum, could have been implemented in flight software, thus allowing the full benefit of its operation. Similarly, diagnostics are slightly more difficult given that only a limited set of XACT housekeeping parameters are being downlinked in order to save space. Again, in hindsight it would have been preferable to reduce the XACT telemetry rate in exchange for adding the full set of data.

One area of performance that is not met to the required level is *geolocation* of the radiometer FOV (within 25 km on the ground). Although the orbit *position* can be determined accurately from the on-board GPS receiver, the *attitude* cannot be determined to the required accuracy. The location of the XACT and orientation of the ST within the spacecraft is constrained by several factors: the radiometer occupies the top of the spacecraft (+Z axis), the antenna occupies the opposite end (-Z axis), and on either side ( $\pm X$ ), the deployed solar panels obstruct and may reflect sunlight into the ST's field of view (FOV). The only remaining option is to orient the ST to point opposite the sun (FOV toward the +Y direction), with the XACT between the UHF antenna and the rest of the spacecraft. In this location, and given vehicle dynamics, at low beta angles the ST is obscured for half of the orbit due to Earth occultation. At high beta angles, the ST works for almost the entire orbit, but the science instrument is normally turned off due to thermal considerations (short eclipse times, hot instrument, and unusable data). To compound the issue, the IMU in this first-generation XACT has an unexpectedly large thermal drift-rate, on the order of several degrees per second over the range of temperatures seen in a single orbit, which presents problems when trying to extrapolate the attitude through periods of ST FOV occultation lasting up to 45 minutes. This results in less than optimal geolocation using the ST and IMU alone, as was originally expected. Nonetheless, with accurate knowledge of the spin rate derived from instrument observations, the sun sensor, magnetometer data, and on-board GPS, geolocation can be determined to be about 31 km on the ground, which is sufficient to meet instrument verification objectives.

Overall, the IceCube ACS has performed very well and has only required some minor post-processing

adjustments, with little maintenance after commissioning.

### ***Flight Software***

The IceCube flight software uses the Salvo Real-Time Operating System (RTOS). Salvo is a commercially available OS designed for embedded systems with extremely limited resources. Salvo is an event-driven, cooperative (non-preemptive), multitasking RTOS. The flight software implements the following three distinct spacecraft modes:

1. *Deployment Mode (DM)*: During initial power up, the flight software enters DM, which has a built-in 30 minute delay (per ISS requirements) before appendages are commanded to deploy, and the transceiver is switched on. The DM includes deploying the stowed solar panels and UHF antenna. If the full deployment sequence is executed and verified, the software sets a flag stored in flash memory to indicate a successful deployment.

2. *Safe Hold Mode (SHM)*: Spacecraft subsystems are powered on, while the instrument is off. The ACS is commanded to SPM, and the transmitter is commanded to broadcast an autonomous status message every 3 minutes (beacon) during the day.

3. *Science Mode (SM)*: The Instrument is powered on. The ACS is in FRM. There are two subsets of this mode. The first one where the instrument is operated only during sun presence (day mode), and the second when the instrument is operated as long as it remains within certain operating temperature limits, and hence remains powered-up day or night (thermal mode). The former was the initial operational mode (about 3 months), whereas the latter dominated the rest of the operations. Thermal mode (and hence 24/7 operations) was possible since the battery was sized with ample margin and proved to be able to handle the extended load.

Software mode transitions are outlined in Figure 11. Simplicity is a cornerstone of IceCube's software design, and checks are implemented throughout to safeguard the spacecraft in case battery power is depleted, and/or safe thermal operating limits are exceeded.



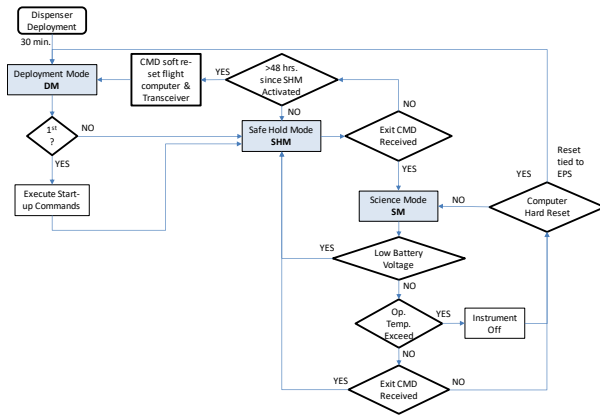

**Figure 11: Software Mode Transitions**

### Communications Systems

The IceCube communications system is a bi-directional UHF link consisting of a COTS half-duplex radio and deployable dipole antenna on the spacecraft, coupled with an 18m parabolic dish and a Software Defined Radio (SDR) located at NASA's Wallops Flight Facility (WFF). The spacecraft radio is the L3 Cadet-U (now owned by Space Dynamics Laboratory) and provides whitened (randomized) downlink data at 3 Mbps using Offset Quadrature Phase Shift Key (OQPSK) modulation along with Turbo Product Code (TPC) Forward Error Correction (FEC). The ground antenna utilizes the Texas instrument CC1101 UHF transceiver configured for whitened 9.6 Kbps data using Gaussian Frequency Shift Key (GFSK) modulation. The Cadet-U provides a single RF port with an internal RF switch on the front-end that is nominally in receive mode until the Cadet-U is commanded to transmit. The spacecraft antenna is a deployable UHF linear dipole provided by Innovative Solutions in Space. The antenna is equipped with redundant I<sup>2</sup>C microcontrollers to control deployment of the two antenna elements and to provide health and status of the unit.

Following spacecraft commissioning, nominal operations of the communications link begins with the IceCube Mission Operations Center (MOC), located at WFF, uplinking a data request command to the flight computer. Once the uplink command is processed, the flight computer commands the Cadet-U to downlink the requested data. The Cadet-U provides 4 GB of on-board storage, where all spacecraft bus and instrument data is stored until downlinked and later cleared by uplink command. The right-hand circularly polarized 18m dish at WFF provides ~36 dBi of gain and employs additional amplification and filtering prior to sending the RF to the ETTUS Research SDR for demodulation, dewatering, and bit syncing. Due to National Telecommunications and Information Administration

(NTIA) regulations, the spacecraft Effective Isotropic Radiated Power (EIRP) is limited to 1W, which provides marginal link budget at low elevation angles. The static downlink link margin is shown in Figure 12, with the best and worst-case margins depicted depending on antenna aspect angle to the ground. Antenna pattern testing of the flight antenna was performed at WFF, using a 3U aluminum mockup of the spacecraft. A snapshot of the tested antenna pattern results is shown in Figure 13.

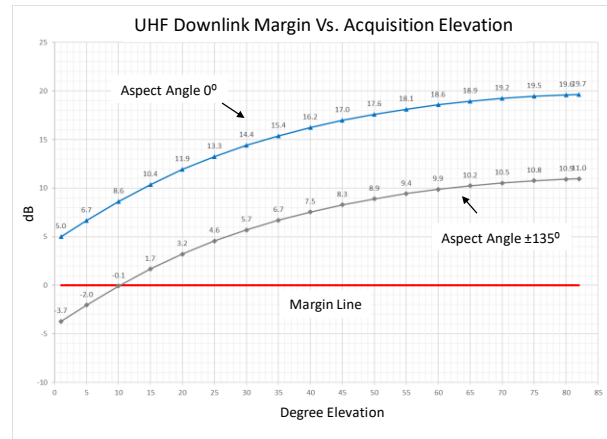
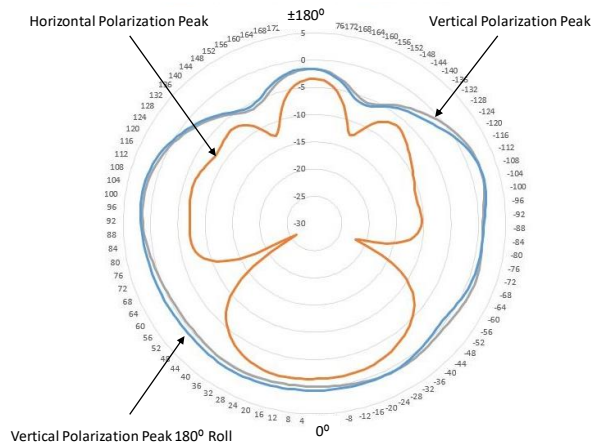

**Figure 12: IceCube Downlink Link Margin (Best and Worst Cast Static Links Shown)**

### Ground Station

The IceCube ground station consists of a single computer located in the MOC that uses L3's InControl Software, and a Space Dynamics Lab (SDL) Titan system located at the UHF antenna site. This system is designed to allow the MOC computer to connect to Titan and establish communication between the MOC, UHF antenna, and the IceCube spacecraft (Figure 14). Once this connection is made commanding and telemetry downlinks are possible.

Command and telemetry databases were created to define command and telemetry formats. Information pages provide users with the commands available and display downlinked telemetry data received (Figure 15). The IceCube ground station was configured such that the integration and test teams could perform RF communications with the Cadet Radio along with internet access to the IceCube umbilical during development. All downlinked data is archived on the MOC computer, and a data extraction application allows archived pass data to be extracted and distributed to Project Design Leads (PDL's) and the science team.



**Figure 13: Spacecraft Antenna Pattern Test Results (Horizontal and Vertical Polarization Data Shown)**

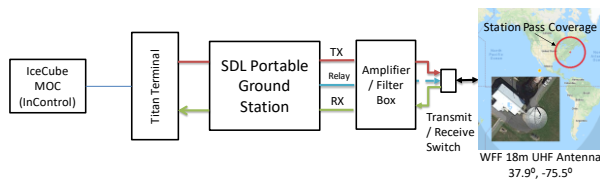

**Figure 14: IceCube Ground Station Configuration**

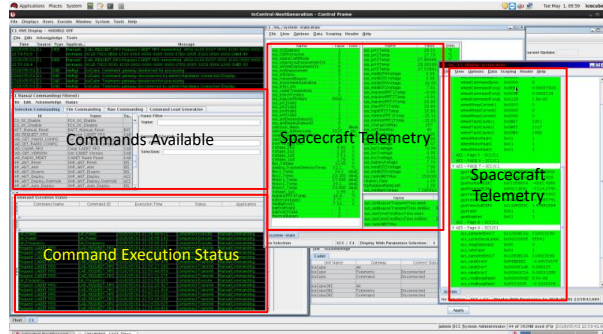

**Figure 15: IceCube Ground Station Display Screen**

## SYSTEM-LEVEL INTEGRATION AND TEST

IceCube system-level integration and test required a careful balance between available resources, and the clear desire to identify mission-ending problems. There were several key decisions, repairs, and replacements that in the end ensured mission success. These were:

1. Re-wiring of the spacecraft harness to allow the use of redundant solar panel deployment switches, and the accompanying increase in switch current capacity.

2. Replacement of failed solar panel burn-wire resistors, and insistence in leaving one circuit pristine. Only electrical continuity was tested.

3. Replacement of failed flight battery board component with ETU. The ETU was flight-qualified to NASA ISS safety standards in a matter of days after the problem with the flight unit was discovered.

4. Re-wiring of triple-redundant inhibit switch connection to ground, which was the suspect in battery board component failure.

5. Replacement of failed mechanical deployment switch, and workmanship qualification (vibration) of replacement unit (also carried out in a matter of days).

6. Updating of flight software to include a daytime-only operation, ability to update instrument operating thermal thresholds during flight, and ability to verify validity of decision-point sensors, with ground-override capability if necessary.

The spacecraft was required to comply with at least those test requirements imposed by the NanoRacks deployment system. Additional flight-qualification testing was also carried out to ensure mission success. Even for resource-strapped missions such as “no-class” CubeSats, testing is imperative to avoid the 20% to 50% loss of missions.

Table 4 identifies the system and component test levels. System tests were required. Component tests were carried out as needed and were considered optional at the discretion of the subject matter experts and technical systems manager. However, they were recommended (and encouraged) for new or modified designs. Maximum Predicted Environments (MPE) for vibration were as required from NanoRacks documentation (NR-SRD-052 Rev. 0.1), and are shown in Table 5.

It is worth noting that given budget constraints, only spacecraft self-compatibility testing was required. Although it was shown during testing that there was no detectable Electro Magnetic Compatibility (EMC) problem between spacecraft bus and instrument, a full Electro Magnetic Interference (EMI)/EMC test would have isolated any possible EMI that could explain some of the (manageable) instrument behaviors seen on orbit.

**Table 4: IceCube Test Levels**

Tests	System Test (Required)	Component Min. Workmanship / Acceptance Test (optional)
<b>Random vibration</b> (IceCube inside dispenser OR Component as indicated)	MPE for (1) minute, each of (3) axes <sup>1,2</sup>	GEVS (Table 7) for (1) minute, each of (3) axes
<b>Sinusoidal Vibration</b>	Not required	Not required
<b>Shock</b>	Not required	Not required
<b>Thermal Vacuum Cycle</b> (IceCube only OR Component as indicated) Ref.: MIL-STD 1540 B, GSFC-STD-7000	MPE <sup>3</sup> +/- 10° C Cycles = 4 (min) Dwell Time = 1 hour min. @ extreme temp. after thermal stabilization Transition = < 5° C/minute Vacuum = 1x10 <sup>-4</sup> Torr	MPE <sup>3</sup> +/- 5° C Cycles = 2 Dwell Time = 1 hour min. @ extreme temp. after thermal stabilization. Transition = < 5° C/minute Vacuum = 1x10 <sup>-4</sup> Torr
<b>Thermal Cycle</b> <sup>4</sup> (Component only)	N/A	MPE <sup>5</sup> +/- 20° C Cycles = 3 Dwell Time = 1.5 hour min. @ extreme Temp. after thermal stabilization Transition = < 5° C/minute
<b>Thermal Vacuum Bake out</b> <sup>6,7,8,9</sup> (IceCube OR Component as indicated) Ref.: MIL-STD 1540 B, GSFC-STD-7000	MPE <sup>3</sup> +/- 10° C Cycles = 1 Dwell Time = Min. 3 hour after thermal stabilization Transition = < 5° C/minute Vacuum = 1x10 <sup>-4</sup> Torr (min)	MPE <sup>3</sup> +/- 10° C Cycles = 1 Dwell Time = Min. 3 hour after thermal stabilization Transition = < 5° C/minute Vacuum = 1x10 <sup>-4</sup> Torr
<b>EMI/EMC</b> <sup>10</sup> (IceCube OR Component as indicated)	Self-compatibility testing required.	Not required, but recommended to detect early problems as system is built-up.
<b>Magnetics</b> (IceCube only)	Measured with internal (XACT) and/or external (laboratory) magnetometers.	Not required.
<b>Burn-In</b> (IceCube only)	100 hours continuous error-free operation.	Not required.
<b>Mass Properties</b> (IceCube OR Component as indicated)	Mass, CG, MOI (Stowed test only, deployed by analysis)	Individual component mass (only) measurement required.
<b>Hardware Configuration</b>	<i>Dispenser</i> – Flight unit (includes flight NEA, cable and connector) <i>CubeSat</i> – Flight unit	<i>Component</i> – Flight component

(1) Levels are defined to be at the dispenser to Launch Vehicle

mechanical interface  
 (2) Dynamic Environments random MPE (Maximum Predicted Environment) as provided by dispenser provider.  
 (3) Thermal MPE includes contingency required by design rules (thermal model).  
 (4) Thermal Cycle is not needed for a component that will undergo Thermal Vacuum Cycle. The quality of workmanship and materials of the hardware shall be sufficient to pass thermal cycle test screening under ambient pressure if the hardware can be shown by analyses to be insensitive to vacuum effects relative to temperature levels and temperature gradients.  
 (5) Thermal cycling testing performed as a screen for mechanical hardware with no heat generating devices may be tested to Thermal-Vacuum Cycle Test factors.  
 (6) CubeSat Thermal vacuum bakeout is required unless LSP removes the requirement for individual CubeSats based on material selection, quantities and manifesting.  
 (7) Maximum bake out temperature set to same maximum temperature for thermal cycle test for consistency, assuming bake out would be performed during same vacuum exposure.  
 (8) If the MPE +10° C < 70°C, the CubeSat shall hold a minimum temperature of 60°C for a minimum of 6 hours.  
 (9) Thermal bake out temperatures are not to exceed qualification temperatures.  
 (10) Additional testing may be required if self-compatibility test fails.

**Table 5: NanoRacks Random Vibration Test Profile**

Frequency (Hz)	Maximum Flight Envelope
20	0.057 g <sup>2</sup> /Hz
20-153	0 dB/oct
153	0.057 g <sup>2</sup> /Hz
153-190	+7.67 dB/oct
190	0.099 g <sup>2</sup> /Hz
190-250	0 dB/oct
250	0.099 g <sup>2</sup> /Hz
250-750	-1.61 dB/oct
750	0.055 g <sup>2</sup> /Hz
750-2000	-3.43 dB/oct
2000	0.018 g <sup>2</sup> /Hz
OA (grms)	9.47

**Thermal Vacuum Test**

IceCube had a 6-day system-level Thermal Vacuum (TV or TVAC) test performed at GSFC’s WFF F-7 chamber. The primary purpose of the TVAC test was to qualify IceCube for space flight. The test campaign had four objectives: 1. verifying complete, repeated system functionality at qualification temperatures, 2. verifying system-level workmanship, 3. verifying battery heater circuit performance, and 4. baking out the spacecraft.

There were four TVAC cycles, and two thermal balance points. There was also a cold mechanism deployment, a hot bake-out test, and three hot/cold starts. Limited Performance Testing (LPT) was done at all TVAC soaks. Instrument calibration was performed towards

the end of the test. A heater panel facing the  $-Y$  side of the spacecraft was used to simulate the predicted heat absorbed by the solar panels. Figure 16 shows the as-run TVAC test profile.

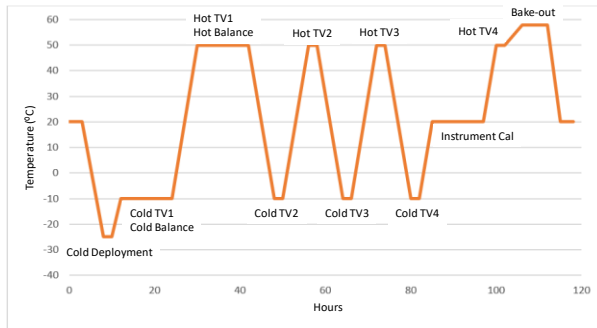

**Figure 16: IceCube TVAC Test Profile**

### **Solar panel deployment during TVAC test**

An event worth noting during TVAC testing was the deployment of the solar panels. During spacecraft I&T and after vehicle vibration testing, it was discovered that the solar array deployment burn resistors had (all) failed due to a combination of poor or ambiguous vendor documentation, excessive cycles, and long actuation times that required panels de-integration, and replacement of faulty resistors. Vibration was determined not to be a factor. A balance between acceptable verification testing, and actuation duration had to be reached in order to ensure those problems would not arise again. Leading into TVAC testing, it was decided that only the primary circuit would be used during panel deployment tests, and the redundant circuit (and resistors) were to be left pristine, and only verified through electrical continuity prior to panel integration. The actuation time was further reduced to 10 seconds. This duration proved insufficient once it came time to deploy the panels in the chamber (cold deployment) as one of the solar array wings failed to open. A test was devised to energize the circuit for as long as it took to deploy the additional wing. Results showed actuation after about 15 seconds. The flight software was then adjusted to command actuation for as long as 30 seconds on orbit. As noted, it was the *redundant* circuit what eventually deployed both solar panel wings on-orbit. Clearly, the decisions to leave that circuit pristine, and to rewire the harness to allow redundancy, were mission-saving. A lesson concerning COTS “single-use” circuits, albeit not identified as such in documentation was learned, which proved incompatible with NASA standards of testing. Figure 17 shows wing deployment, where the instrument aperture is at top left.



**Figure 17: Solar Panel Deployment in TVAC**

In all, IceCube underwent two vibration tests, one TVAC test, and one end-to-end mission simulation test that exercised the system and flight software through critical operational stages, from deployment to science operations. The *second* vibration test was carried out *after* TVAC testing and was required due to debris discovered during the first test. That debris was attributed to excessive use of adhesive (Appli-Thane) needed to stake fasteners and the GPS antenna to the spacecraft body. A picture of IceCube after TVAC testing is shown in Figure 18.

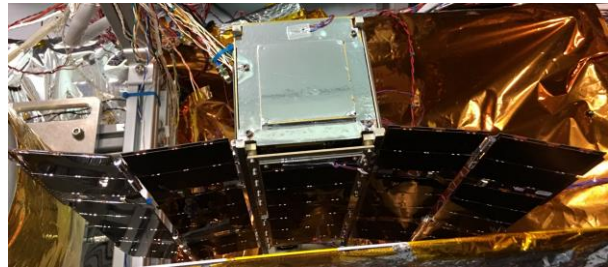

**Figure 18: IceCube at the End of TVAC Testing**

Existence of debris after vibration also pointed to another problem identified after TVAC test completion: a sudden change in instrument gain. The leading cause of this change was debris in the sub-millimeter receiver horn. After some debate, it was decided the instrument was *good enough*, to be flown as-is. Anything else would have required disassembly, trouble-shooting, re-execution of testing, and most likely a missed-opportunity to launch, all potential mission-ending activities in a constrained budget. In hindsight, an instrument cover during integration and vibration testing may have obviated this difficulty. Fortunately, the gain change did not significantly impact the instrument performance or technology validation.

### **ISS DEPLOYMENT AND COMMISSIONING**

IceCube was deployed from the International Space Station (ISS) on 16 May, 2017 at about 410km altitude and 52° inclination (Figure 19). Deployment sequence started about 5 minutes into orbit night, after the prerequisite 30-minute wait time. About 1hr 17min after release, the WFF 18-meter antenna acquired IceCube’s beacon telemetry for the first time.





**Figure 19: IceCube is Released from the ISS Over the South Atlantic Ocean**

All systems showed nominal performance. Telemetry also indicated the UHF antenna was deployed on first attempt, and solar panels deployed after second attempt (redundant circuit). The ACS was controlling the vehicle in SPM, and spin about the sun-line was at a nominal rate of  $\sim 1^\circ/\text{s}$ . Commissioning phase included a thorough check of all subsystems, and accurate determination of the spacecraft’s orbit. The latter turned out to be the most challenging aspect of commissioning. After about 31 orbits (2 days after release), IceCube had drifted far enough from the ISS that predicting its position within the narrow  $3^\circ$  ground antenna beam became uncertain. Therefore, telemetry was lost and was not acquired until a NORAD Two-Line Element (TLE) became available and IceCube was identified among the cluster of CubeSats deployed from the ISS at the same time.

In order to determine the spacecraft’s fate after initial telemetry loss, a crude “ground system” was set-up to receive beacon signals. A 7.5 dBi,  $45^\circ$  beam Yagi antenna connected to a portable spectrum analyzer was trained in the general direction of the predicted position of IceCube. A beacon signal with a signature similar to IceCube’s last known transmission was detected after a several tries, and 7 days after contact was lost. This was soon confirmed by NORAD’s two-line element (TLE), and commissioning phase could begin in earnest. Figure 20 shows the crude set-up used. The low gain antenna and imprecise tracking was sufficient to detect at least one beacon per pass, and points to the use of greater beam ground systems for initial acquisition and tracking of LEO CubeSats in the future, or for contingency searches.



**Figure 20: Crude “Ground System” Used to Detect IceCube Signals after Loss of Communications**

IceCube 883-GHz cloud radiometer was powered-on for two orbits on June 6 2017, or about three weeks after initial release. The instrument showed good sensitivity to Earth and space scenes (Figure 21). All data indicated that both spacecraft and instrument were healthy, and the cloud radiometer could begin technology validation.

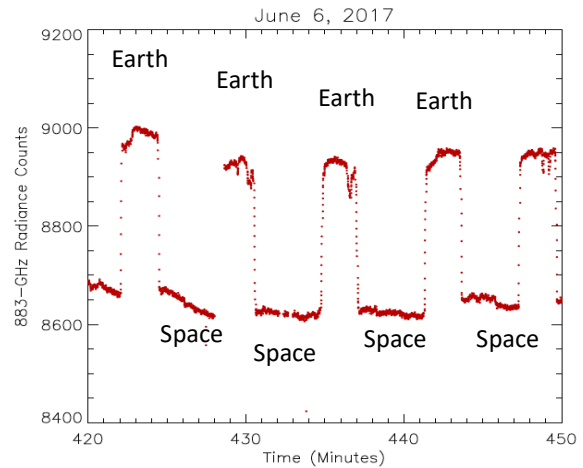
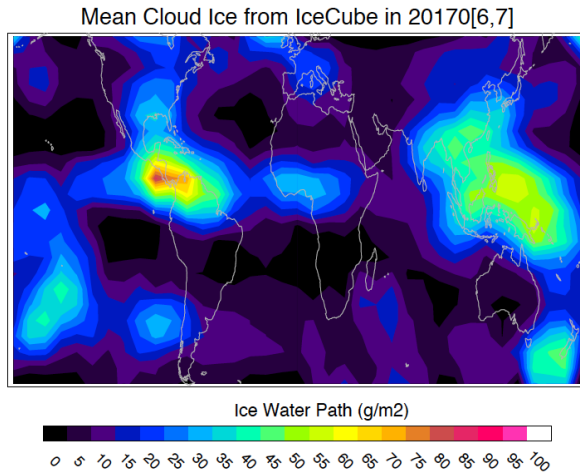

**Figure 21: IceCube First-Light Data**

**TECHNOLOGY AND SCIENCE RESULTS**

The spinning CubeSat allows the 883-GHz cloud radiometer to view the Earth’s atmosphere and cold space periodically. Frequent space views provide the measurements critical for radiometric calibration of the receiver system. Figure 22 is the first 883-GHz cloud ice map obtained shortly after IceCube became operational. The 883-GHz radiance, sensitive to ice particle scattering, is proportional to cloud ice column amount above  $\sim 8$  km. The cloud map acquired from June-July 2017 shows a clear distribution of the inter-

tropical convergence zone, as well as the classic Gill-model pattern over the Western Pacific and Indian monsoon regions. After release from ISS, IceCube has been flying on an orbit similar to ISS, but its orbital height has decreased from 410 km in May 2017 to ~340 km in May 2018. Given its orbit inclination, the coverage of IceCube cloud observations is limited to 52S – 52N latitudes.



**Figure 22: IceCube Cloud Ice Map Acquired from Measurements During June 6-July 19, 2017. The Ice Water Path, in g/m<sup>2</sup>, is the Integrated Cloud Ice Mass Above ~8 km in the Troposphere.**

Although IceCube was intended as a technology demonstration spacecraft, it has proven that even miniaturized instruments such as this can yield “good enough” science, and that CubeSats serve as excellent platforms from which larger, more complex instruments can be designed and implemented in the future. Even though IceCube’s radiometer is in flight and acquiring technology and (bonus) science data, its Technology Readiness Level (TRL) stands at 7 as was the original objective: a prototype demonstration carried out in the space environment. A higher TRL instrument however, would not only observe in the 883 GHz frequency, as now demonstrated on orbit, but also concurrently in other frequencies in order to provide the full-range of measurements needed to probe the Earth’s atmosphere.

### LIFETIME PREDICTION

IceCube EOL activities will involve a series of experiments to gather instrument and engineering data to determine operational limits, e.g., faster spin rate performance. Between about 300 and 250 km, it is expected that aerodynamic forces will prevent the ACS from effectively controlling the vehicle. At the same time, power from the arrays will become unpredictable, and the battery will no longer provide adequate power for the spacecraft. Once the battery voltage limit is

violated, the operations team will command SHM and gather as much engineering data as possible prior to ending spacecraft operations.

Figure 23 shows IceCube’s predicted reentry date depending on model used. Reentry dates range from July through September, 2018.

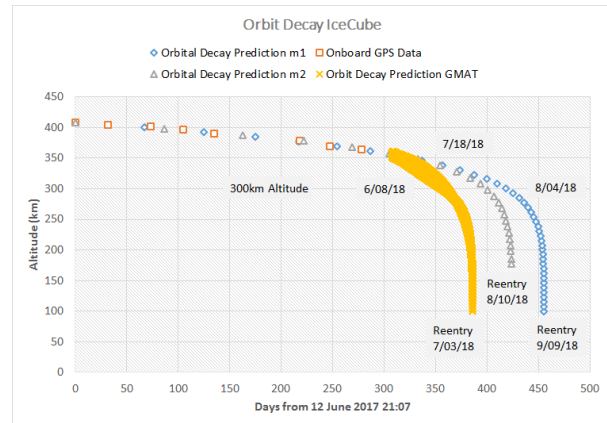

**Figure 23: IceCube Reentry Predictions**

### PROGRAMMATIC LESSONS LEARNED

Although IceCube’s approach was to use as many COTS components as practical, it became apparent that COTS parts are not always “off the shelf”. Many COTS subsystems had lead times greater than six months and at least one key subsystem was delivered 8 months later than contracted. This reality was an important contributor to the longer than (originally) anticipated 24-month end-to-end development schedule. Adding to delays, *none* of the COTS components would “plug and play,” and *nearly all* components had to be modified by the IceCube team and/or returned to the vendor for modification. Finally, the product documentation for the majority of components was found to be incomplete and it was difficult to obtain timely responses from some vendors, particularly those located in separate continents.

It was quickly learned that staffing IceCube would be challenging. Developing a custom instrument and one of a kind spacecraft would require support from numerous highly skilled engineers and technicians. Originally, it was thought that dedicated multi-skilled software, hardware, and systems engineers would be sufficient if supplemented by subject-matter experts in specific areas. This premise failed to work, and skill-sets had to be split among numerous individuals. Consequently, due to the relatively low-level of funding allocated to IceCube, each team member could only support IceCube for a small fraction of their time, with

some subsystems seeing a revolving door of engineers as higher priority projects demanded their full attention. This made it very difficult to obtain support in a timely fashion. It was also learned that some implementation approaches, such as software, do not necessarily scale from previous missions, unless designed as such *a priori*, and require significant changes.

At the start of IceCube's development several key requirements were not known and many more depended upon the launch manifest, which was not itself known until two years after Authority to Proceed (ATP), and 6 months prior to launch. This caused a great deal of uncertainty in the design and increased costs for both manpower and procurements. For example, the batteries increased in cost by nearly an order of magnitude to make them compliant with ISS man-rated safety requirements.

IceCube was delivered to the launch vehicle provider 32 months after ATP. Technology development is an inherently risky proposition and any successful endeavor, no matter the roadblocks along the way, is to be commended. Given this experience, there is no doubt the GSFC/WFF team can build high-risk small spacecraft and have them contribute in important ways to the advancement of science and technology.

### ***Acknowledgments***

This work was funded through the NASA Earth Science Technology Office (ESTO), and the NASA Science Mission Directorate (SMD). Many thanks to Robert M. Connerton (ESTO) for his steadfast support and advice. Also from ESTO, many thanks to Michael P. Pasciuto and Pamela S. Millar in advocating for IceCube's success and providing financial support.

There were many individuals who contributed to IceCube's success, either through advice or as team members along the way. These include: Michael K Choi (thermal design), Brian Aulden Corbin (RF communications), Carlos Duran-Aviles (SIC Design, assembly, and test), Henry C. Hart (spacecraft assembly), Amri I. Hernandez-Pellerano (instrument power and iPDU Design, assembly, and test), Derek L. Hudson (science), William R. Mast (mission systems engineering), Eric Z. Pollack (software and C&DH), Paul E. Racette (science), Joel M. Simpson (mission systems engineering), Michael A. Solly (instrument mechanical), Christopher V. Strickland (TVAC).

### ***References***

1. K.F. Evans, J.R. Wang, P. Racette, G.M. Heymsfield, L. Li, "Ice Cloud Retrievals and Analysis with the Compact Scanning Submillimeter Imaging Radiometer and the Cloud Radar System during CRYSTAL-FACE," J. of Applied Meteo., Vol. 44, No. 6, pages 839–859, 2005.
2. NASA Article: <https://www.nasa.gov/feature/goddard/2018/nasa-s-small-spacecraft-produces-first-883-gigahertz-global-ice-cloud-map>