

Bigelow Expandable Activity Module (BEAM) ISS Year-Two

Technology Demonstration, Utilization,
and Potential Future Applications

Gerard Valle & Nathan Wells
BEAM Project Management and
Instrumentation Team

ISS R&D Conference,
San Francisco, CA
24-July-2018



Agenda



1. Project Overview

2. Crew Ingress

3. BEAM General Performance

- Microbial Air & Surface Monitoring
- Deployment Dynamics
- Thermal
- MMOD Impact Detection
- Modal Test
- Radiation

4. Utilization as a Stowage Module

5. Life Extension

6. Future Plans & Summary

7. Team Acknowledgements



BEAM project objectives



- ◆ Demonstrate a commercial expandable habitat module on ISS in partnership with Bigelow Aerospace (BA)
- ◆ Increase human-rated inflatable structure Technology Readiness Level (TRL) to 9
- ◆ Address key elements of NASA's Space Technology Roadmaps to prepare for future deep space and surface habitat missions
- ◆ Exploit experience from NASA's TransHab design and BA's Genesis I & II pathfinder flights

BEAM animation by NASA/JSC on YouTube
<https://youtu.be/VopaBsuwikk>



BEAM expanded configuration



*Not shown: Rip-Stitch Straps (RSS)
next to ADSS struts*

Anomalous Depressurization and
Stabilization System (ADSS) struts (x4)

Flight Support Equipment (x6)

PCBM to Bulkhead
Tunnel Adapter

BEAM Hatch

Forward Bulkhead

PCBM

BEAM IMV Duct

Soft Goods (SG)
Assembly

Shear Panel (x8)

Aft Bulkhead

Air Tanks (x8)

Longeron (x4)

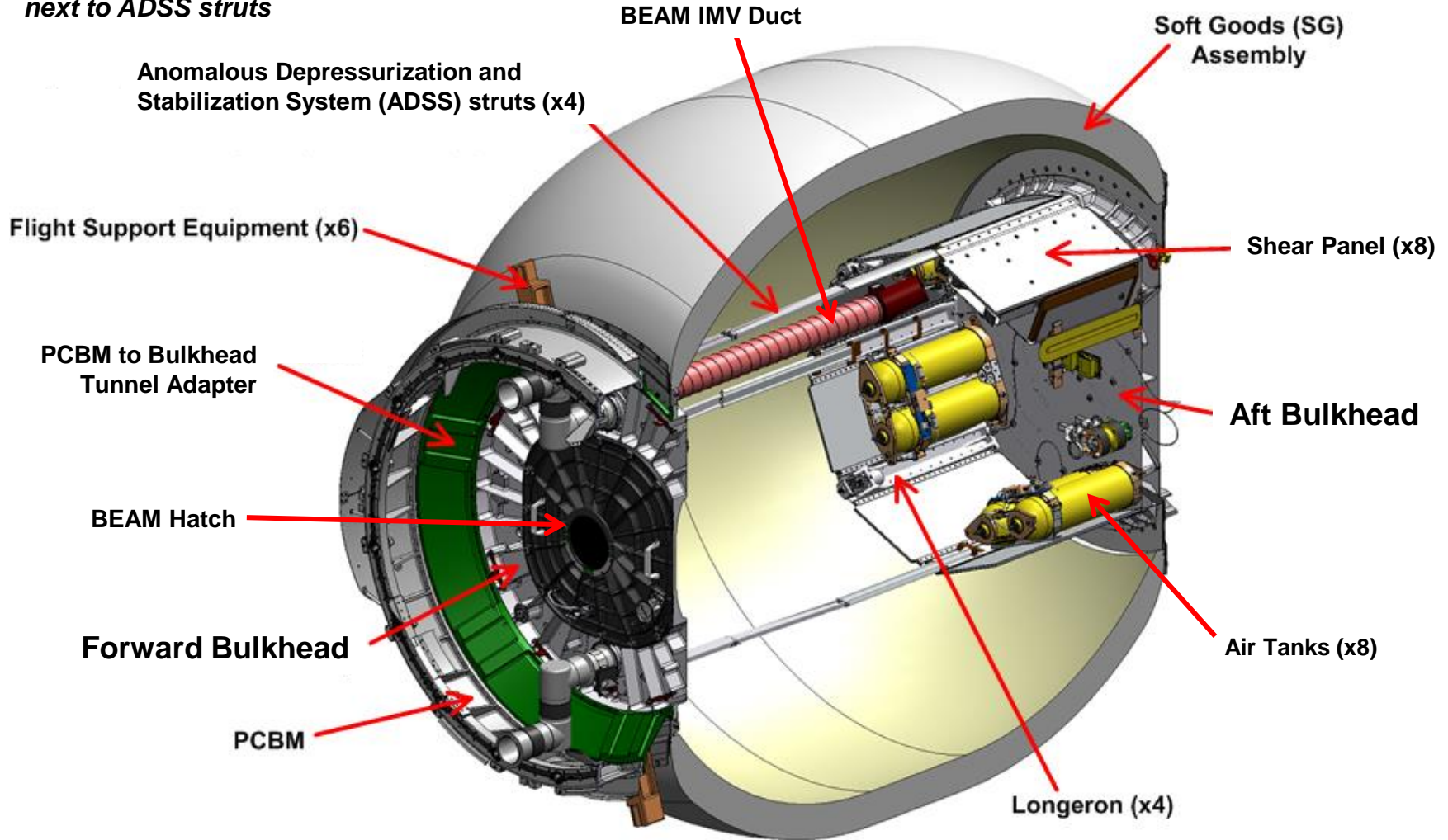



BEAM launched, berthed, and deployed on ISS



- ◆ BEAM launched on SpX-8 (April 8, 2016), Dragon/BEAM arrived Node 2 (April 10th), SSRMS extracted BEAM from Dragon Trunk on Node 2 Nadir, moved it to Node 3, and berthed it on Node 3 Aft port (April 15-16 2016), and fully pressurized on May 28, 2016.

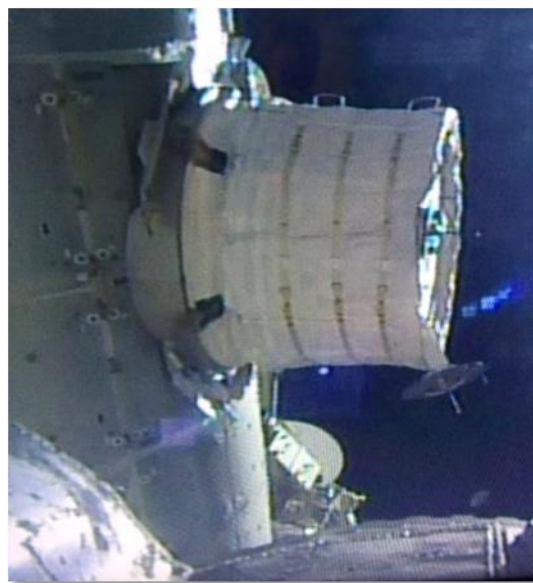
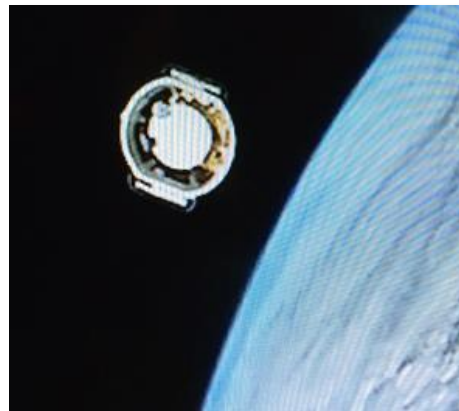



BEAM Ingress Timeline (through 2-years)



Ingress	Date	Operations
1-3	June 6-8, 2016	Outfitting interior, installed sensors, and took microbial air/surface samples
4	5-Sep-16	Replaced DIDS battery packs --> DIDS back to nominal ops, reattached 5 accelerations to shell with Kapton tape, retrieved exposed RAM's for return in Soyuz 46S
5	29-Sep-16	Performed Modal Test; IWIS data not recorded due to bad cable connection, preemptive Kapton-taping of 7 accelerometers
6	24-Oct-16	RAM install and microbial sampling
7	1-Feb-17	2nd Modal Test, RAM swab and microbial sampling
8	22-Mar-17	RAM swap, microbial sampling, accelerometer inspection
9	28-Apr-17	1st REM shield installed (1.1 mm thick)
10	31-May-17	2nd 3D-printed REM shields (3.3mm thick) installation & new RAMs
11	20-Jun-17	3rd (final) 3D-printed REM shield (10mm thick) installation
12	31-Jul-17	flipped 10 mm dome
13	22-Aug-17	microbial sampling
14	20-Nov-17	removed pressurization tanks, stowage box, cables, ...
15	21-Nov-17	installed hardwire sensors, PMA, duct extension, empty M-bags, microbial sampling
16	22-Feb-18	microbial sampling, reattach sensors, remove 10mm REM shield, LEE and CTB stowage
17	18-May-18	WTS 1003 battery replacement, microbial/air sampling
18	TBD	LEE removed, DIDS cable swap (extension), DIDS and WTS battery swap
19	TBD	Add supplemental BEAM Stowage (up to 109 CTBE).
20	



BEAM – Microbiological Monitoring



- ◆ **Nine separate microbiological monitoring sessions occurred on:**
 - June 8, 2016
 - September 5, 2016
 - October 24, 2016
 - March 22, 2017
 - June 20, 2017
 - August 22, 2017
 - November 21, 2017
 - February 22, 2018
 - May 18, 2018
- ◆ **All microbial concentrations from air and surface samples were well below the Medical Operations Requirement Document (MORD) limits. No fungi were isolated from any samples.**
- ◆ **No medically significant microorganisms were isolated from any samples.**
- ◆ **Future sampling will continue to be performed 3 to 4 times per year through life of BEAM/ISS.**



BEAM Sensor System Overview



Sensor	Parameter	Deployment	Data Retrieval	Previous Use
Distributed Impact Detection System (DIDS)	Detects structural impacts to BEAM	Installed pre-launch: •4 transducers on the bulkheads Installed on orbit: •12 transducers on the soft goods •sensor boxes	RF to SSC (closed hatch)	ISS Ultrasonic Background Noise Test SDTO
Deployment Dynamics Sensors (DDS)	Records acceleration loads during inflation stage	3 DDS units and triaxial accelerometers are installed prelaunch	USB to SSC (BEAM ingress)	Shuttle Wing Leading Edge accelerometers and Crew Seat DTO
Wireless Temperature Sensors (WTS)	Monitors temperature of BEAM surface (IVA)	4 WTS units Installed on-orbit (qty 4 RTD channels each)	RF to SSC (closed hatch)	Shuttle Wireless Strain Gauge Instrumentation System
Radiation Environment Monitor (REM)	Monitors radiation environment internal to the BEAM structure	2 REM Installed on-orbit	USB to SSC (closed hatch)	REM SDTO
Radiation Area Monitor (RAM)	Passive radiation monitoring badges	6 RAMs Installed on-orbit	Replaced and returned to ground every Soyuz vehicle cycle	

DIDS



WTS



REM



RAM



DDS

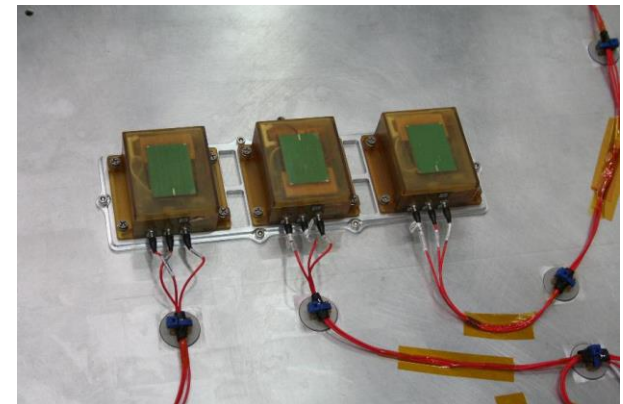



Deployment Dynamic Sensor (DDS)



Purpose: Used as a technology demonstration for characterizing the BEAM Module deployment dynamics with accelerometers on the Aft bulkhead surface.

Deployment: Hardware pre-installed prior to launch on Aft bulkhead.

Qty 3
Deployment
Dynamic
Sensor (DDS)
units

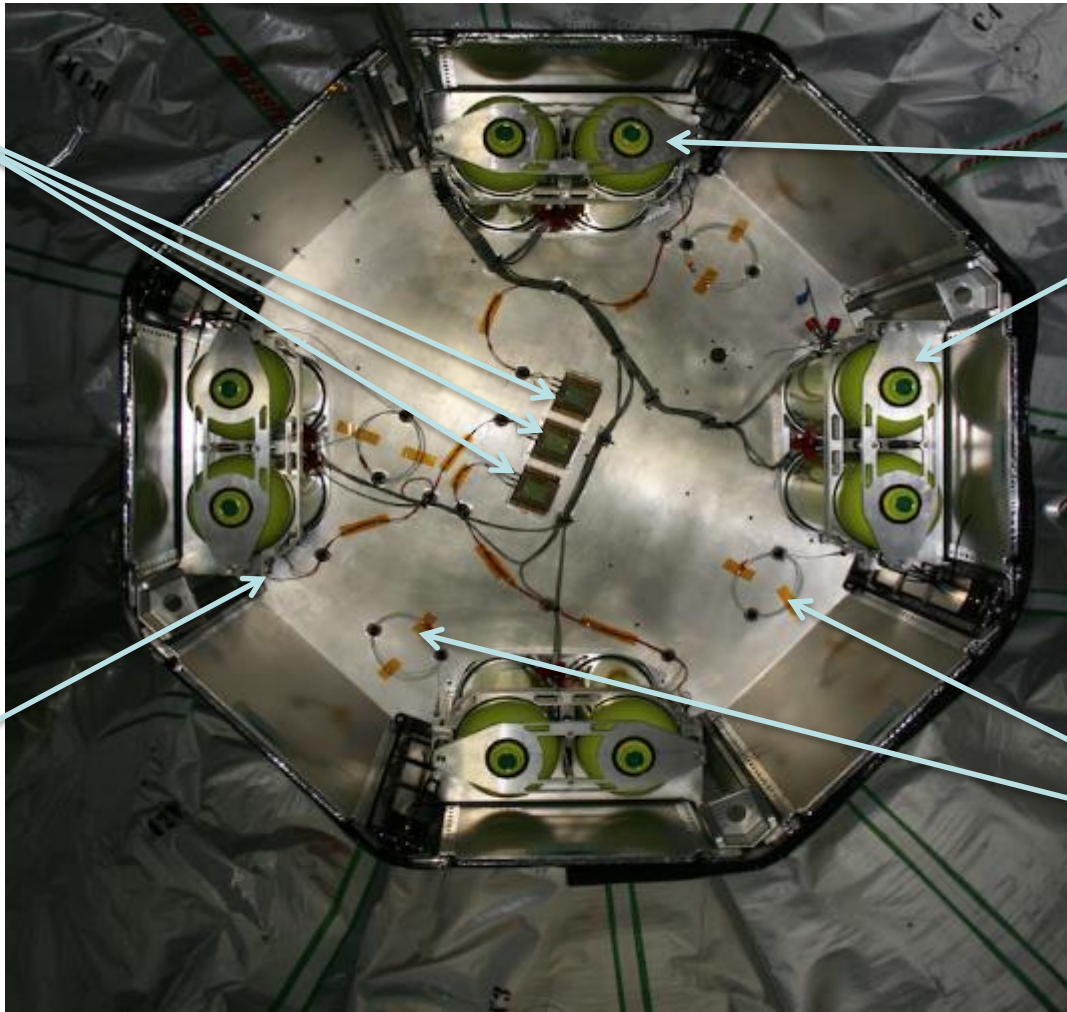

Qty 8 Air
Inflation
Tanks

Qty 3 triaxial
acceleromet
ers

Qty 4
single axis
accels
with
cables for
DIDS



DDS Sensor Results for Deployment Monitoring



- ◆ The DDS successfully recorded 10 hrs of accelerometer data during the BEAM deployment.
 - Thousands of impulses were measured from the Rip-Stitch Strap (RSS) stitches popping.
 - Max 0.5g peak during initial inflation attempt and max 0.3g during the final inflation.
 - No indication of ADSS struts binding or high transient loads on ISS.

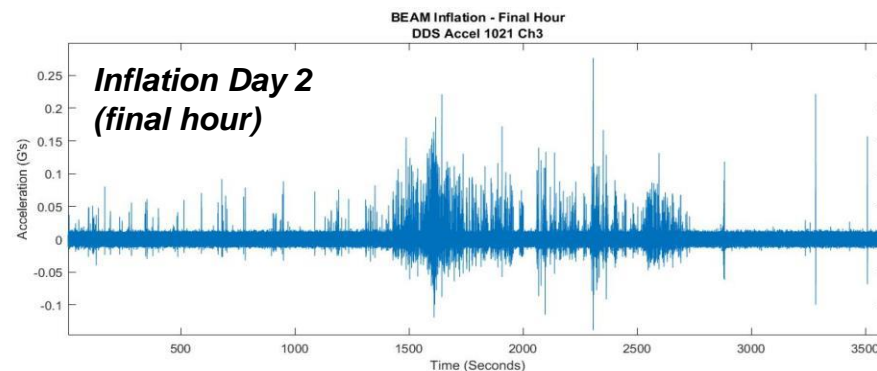
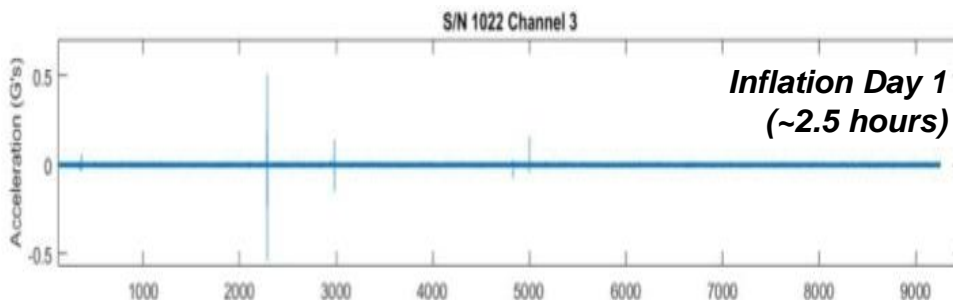

- ◆ DDS was also used to support Modal testing inside of BEAM.



Wireless Temperature Sensor (WTS)



Purpose: Used as a technology demonstration for characterizing the BEAM Module internal temperature environment during the 2 yr operational phase.

Deployment: Qty 4 Wireless Temp System Kits installed on-orbit

Operations: Each WTS data recorder samples 4 Resistive Temperature Device (RTD) channels once per minute and stores to local memory. Data is downloaded wirelessly ~ 1/month to a laptop in Node 3 and then downlinked to the ground.

Qty 4 Resistive Temp Device
Sensor

Qty 1 Extended Life
Battery Pack

Qty 1 Wireless Temp
Sensor

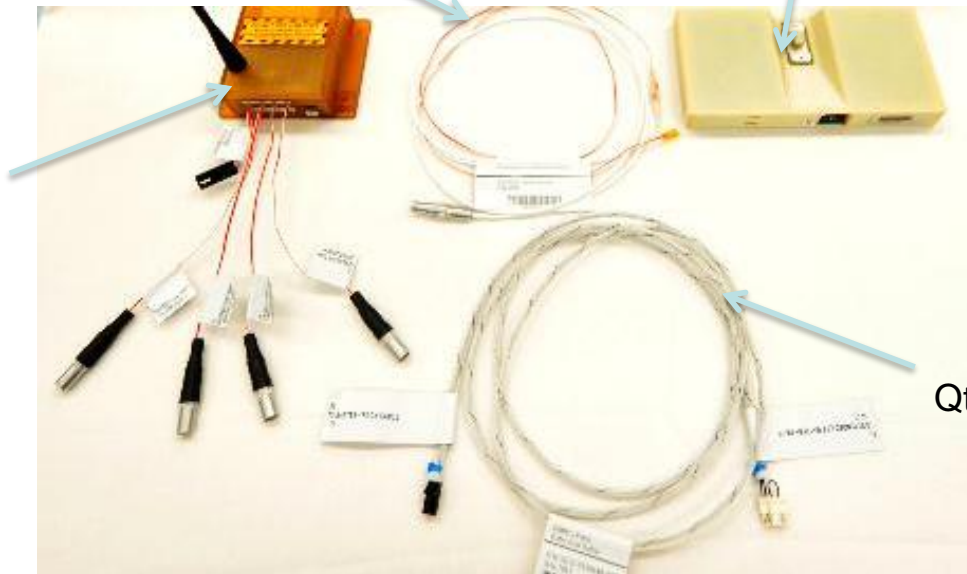

Qty 1 Battery Pack Cable

Wireless Temp Sys Kit Contents

- A total of 16 WTS RTD sensors were installed with tape inside of BEAM.
- 12 sensors were placed radially along the BEAM inner air barrier and 2 sensors on the Forward and Aft bulkhead surfaced respectively. Approximate locations are shown below.
- Initial pre-expansion internal temperatures measured by the DDS system were significantly warmer than predicted analysis temperatures which was likely due to the folded soft goods layer creating an additional thermal isolation not modeled.
- Current model of the Expanded Module tends to under predict the WTS readings.
- BEAM demonstrated adequate thermal control and condensation prevention with unobstructed and **partially obstructed** ventilation from the ISS IMV, nominally at 22.6 °C and 3.4 m³/min, and ISS atmosphere humidity levels (dew point) from 5.6 to 12.8 °C (Relative Humidity 33 – 54%)

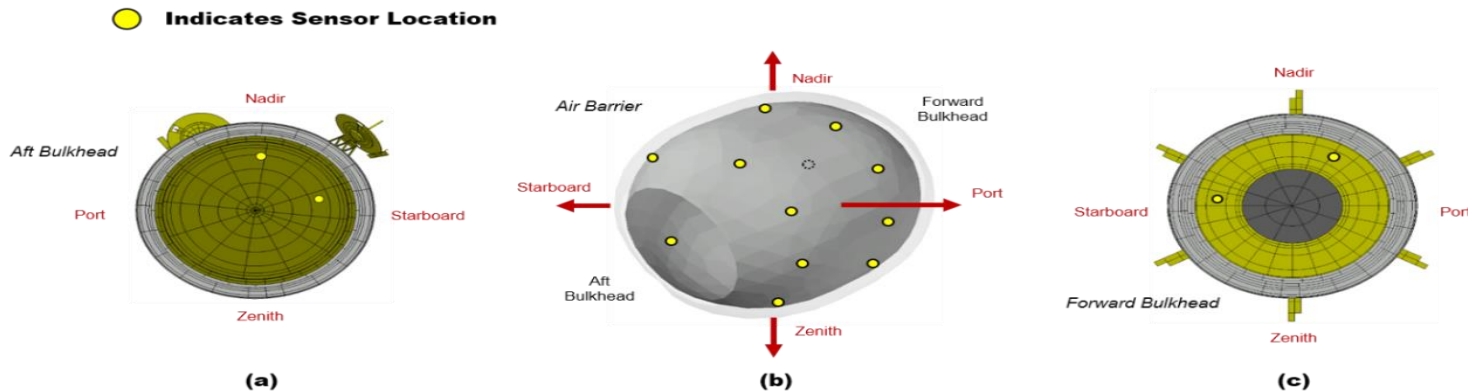

Locations of the 16 WTS sensors (a) BEAM aft bulkhead, (b) air barrier and (c) forward bulkhead*

* Graphics and data on this slide and the next were provided by the BEAM NASA/JSC Passive Thermal Principle Investigators John Iovine & William Walker

Purpose: Used as a technology demonstration for Micro Meteoroid/Orbital Debris (MM/OD) Impact detection system of an inflatable structure for BEAM Module during the 2 yr operational phase.

Deployment: Qty 4 Accel Transducer cables installed pre-launch to Aft Bulkhead and remaining kitted hardware installed on-orbit

Operations: Each DIDS data recorder remains in a low power listening mode until a trigger is recorded above a set g threshold value and records a 270 ms of 30 KHz sampled data window to internal memory for each of its independent 4 channels. New trigger status is downlinked daily and raw trigger can be downlinked on an as needed basis.

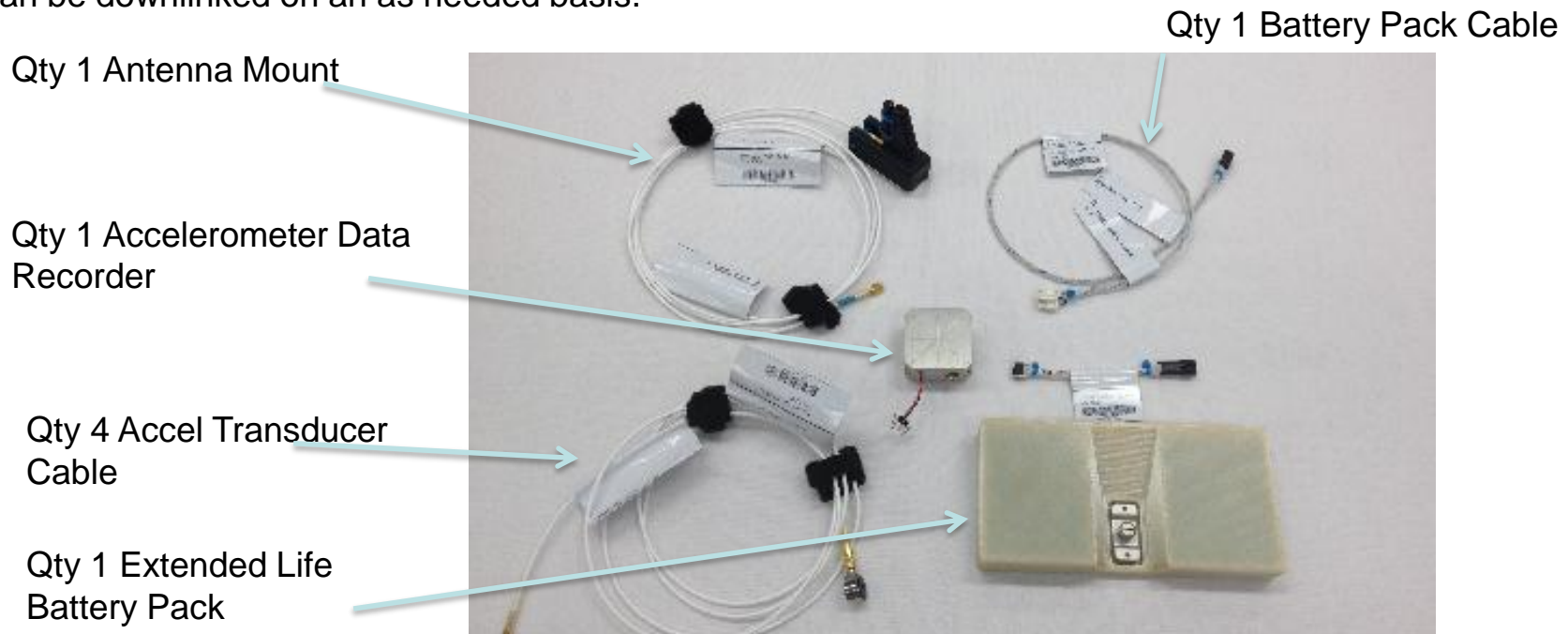

Impact Detection Kit Contents



Distributed Impact Detection System Overview



- ◆ Detects MM/OD and IVA Events
- ◆ Uses 3 VDC custom designed external Battery Pack, expected operational life of 2 years.
- ◆ Can store 9999 events on an internal memory card
- ◆ Verified that adhesive attachment method for accelerometers to smooth surfaces (Bladder) survives HVI impacts.
- ◆ BEAM air barrier had been pre-marked for DIDS/WTS sensor installation locations.
 - ◆ Sensor locations were configured to ensure maximum internal coverage and to monitor pre-flight identified high risk MM/OD impact probability locations.
- ◆ 12 DIDS piezoelectric accelerometers were adhered to air barrier via pre-applied double-sided transfer tape and Kapton tape by crew

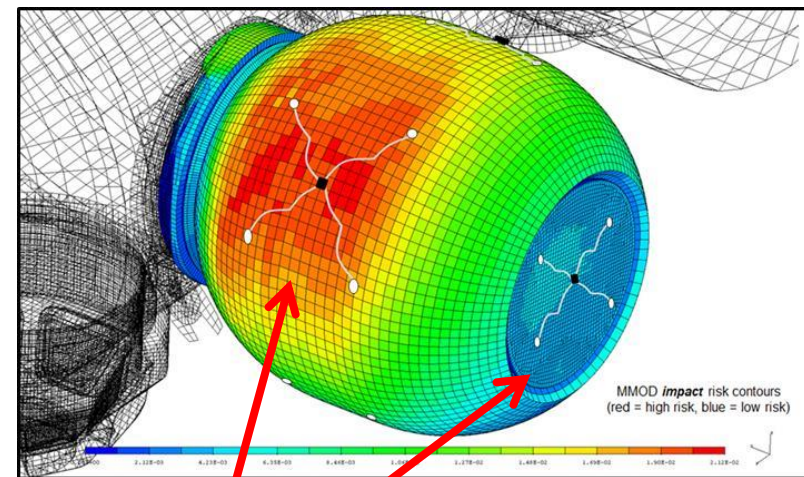

NOTE: NOT Actual sensor location!
DIDS Sensors locations are for illustration purpose only.
DIDS Sensors are Internal to Structure.

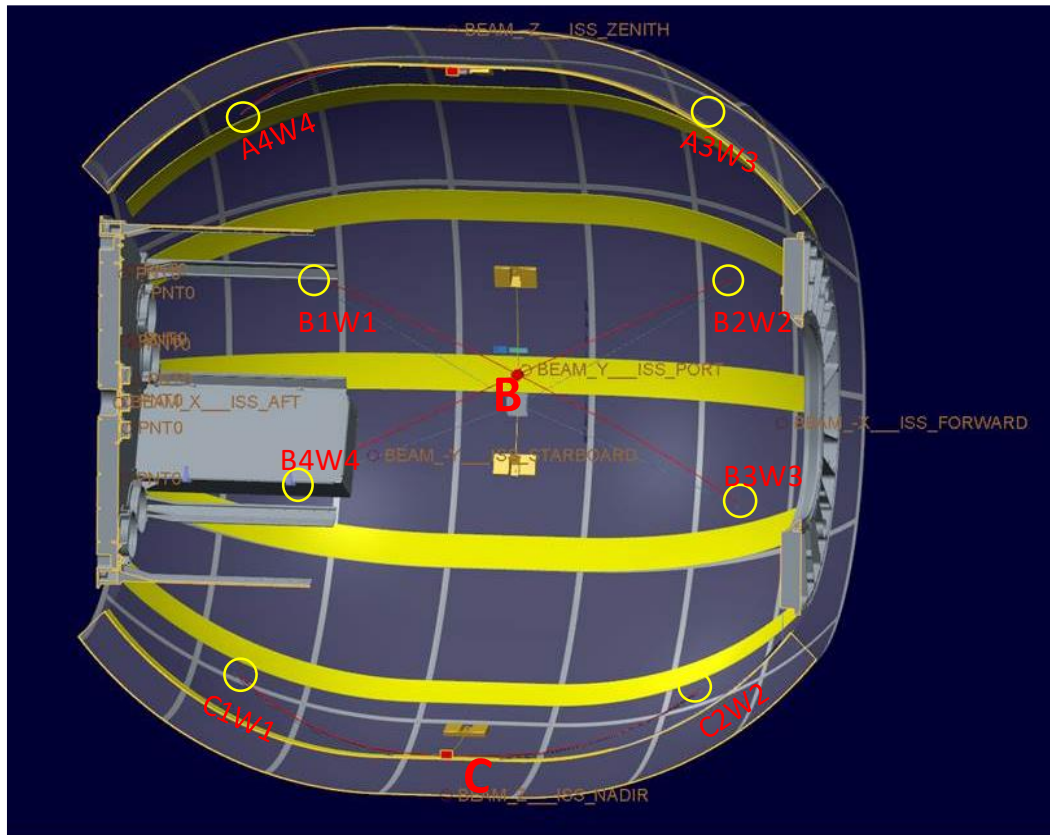

BEAM Sensor 3D Model View

BEAM Mock-up View

Note: Cables attached to inner air barrier with 1 3/8" dia Velcro dots



BEAM Impact Detection Performance Overview



- ◆ Initial DIDS operations required engineering to tweak the trigger threshold parameters to ensure DIDS accelerometers would not falsely trigger due to low level ISS background noise being injected into the module structure.
- ◆ Crew activity induced loads to structure have been routinely recorded during previous crew ingresses in the module
- ◆ DIDS operations had to be adjusted initially to disable an internal amplifier which had been left active and was causing increased power consumption.

- ◆ On GMT 059 (2/28/17) first likely external impact to BEAM was recorded by all three DIDS units monitoring the internal air barrier surfaces. Recorded signals ranged between 1 - 3 g's acceleration

- ◆ Signal contained high frequency content

- ◆ Triangulated to have impacted on Zenith side (between Channel 2 & 3)

- ◆ Estimated impact amplitude on restraint layer is ~260 g's based on hypervelocity ground test derived models and data suggests the impact would not have penetrated all the way to the restraint layer

- ◆ Pictures of estimated impact location were requested via the ISS External High Definition Camera (EHDC) P1LOOB, however the camera gave very little Zenith surface viewpoint

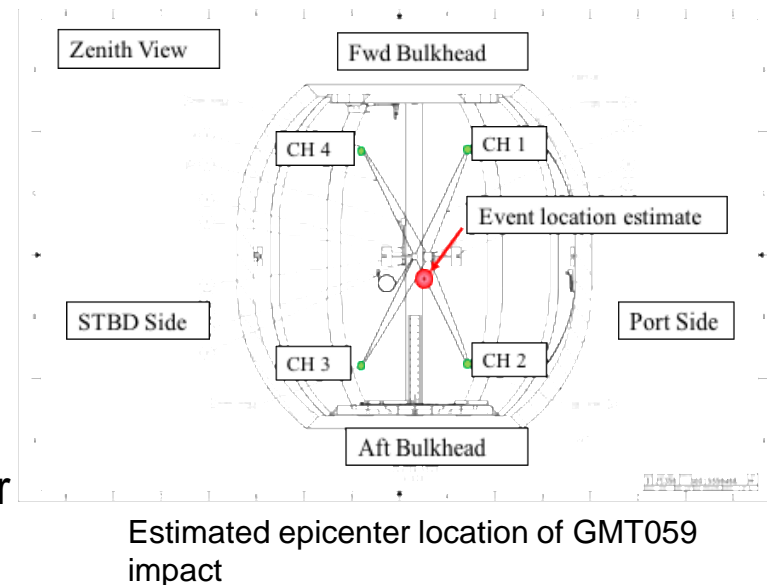

- ◆ A total of 6 Passive and 2 active radiation sensors were installed inside of BEAM via velcro.
- ◆ The Radiation Environment Monitors (REMs) couples small radiation sensor with advanced electronics
 - Consist of a Timepix read-out chip bonded to a 300 μm thick, 2cm² silicon sensor layer.
 - The Timepix provides on-chip data collection and signal digitization within the footprint of each of the individual pixels in the 256 by 256 pixel matrix
 - Power/data provided via USB and connect to Space Station Computer laptop in Node 3
 - Provides spectral information (energy deposition as function of particle type and energy) and radiation dose
- ◆ Radiation Area Monitors (RAMs) came back to ground during nominal ISS Soyuz return cycle for data evaluation. **RAM sensor monitoring discontinued in Dec. 2017.**

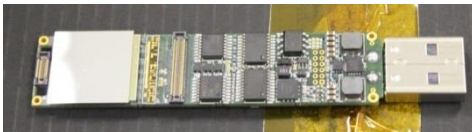

Active Instrumentation (REM)



Passive Instrumentation (RAM)

◆ Radiation (REM) initial results

- System has been operating without issues since installation
- Galactic Cosmic Ray (GCR) dose rate similar to other ISS modules
- As expected, REMs measured higher trapped field dose rate — e.g., in South Atlantic Anomaly (SAA) — inside BEAM than in other ISS modules due to thinner shell and lack of equipment racks in BEAM technology demonstrator
- A test was performed to determine if the particles being measured inside of BEAM are of low energy and if so, can they be effectively shielded out with 3D printed plastic hemispheres of various thicknesses (1.1mm, 3.3 mm & 10mm).
 - Results were inconclusive. No noticeable change noticed.
 - A better comparison will be made when BEAM is filled with stowage items.
- BEAM tech demo data will be used to assess shielding requirements for expandable habitat modules configured for human exploration missions





BEAM Stowage Module Utilization



- ◆ BEAM Contract Updated to support utilization as a stowage module and life extension
- ◆ BEAM completed 2-year certified life under original contract
 - All milestones met and BEAM performed nominally
- ◆ BEAM de-outfitted to support utilization as a stowage module
 - Removed tanks, stowage box, cables
- ◆ Converted wireless WTS and DIDS sensors to wired configuration
- ◆ Extend vent duct to meet air flow requirements
- ◆ Installed 420 pound failed Latching End Effector (LEE) plus 610 pounds of cargo inside of BEAM



◆ BEAM with 109 CTBE Stowage

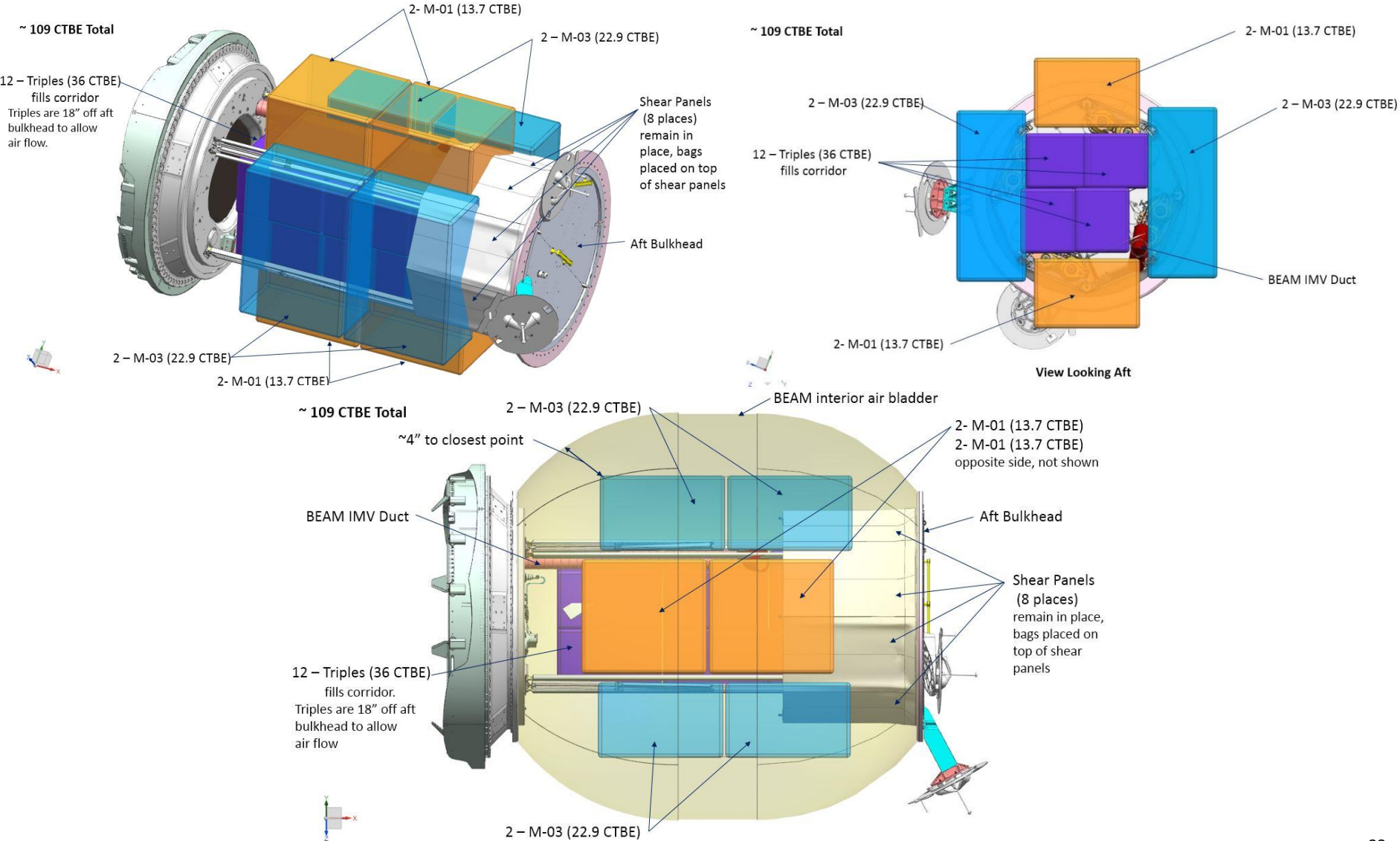



BEAM Life Extension through End of ISS Life



- ◆ BEAM meets MMOD penetration requirements through 12/31/2028
- ◆ BEAM meets stress requirements for a fully loaded (109 CTBE) configuration
- ◆ Fully loaded (109 CTBE) BEAM meets fatigue requirements through 2028
- ◆ ADSS needs to be reinforced in order to meet stress and fatigue requirements for a fully loaded BEAM in the off-nominal depressurized state
 - Currently working on reinforcing ADSS utilizing on-orbit hardware (repurposed handrails)



Future Plans

- ◆ BEAM was originally planned for a 2 yr operational mission to demonstrate and advance the technology with infrequent human ingresses.
 - Utilize BEAM as a stowage module
 - Extend BEAM life to end-of-ISS-life
 - Conduct additional experiments inside BEAM

Summary

- ◆ Overall BEAM has been performing beyond expectations!
- ◆ BEAM has advanced human rated expandable modules to TRL 9 and in the future should be considered as a solution for volume/mass savings in future planetary and space exploration applications.
- ◆ Use BEAM sensor data and lessons learned to fold into future expandable module design



Future Expandable Spacecraft Potential Uses



- Full-sized Inflatable Module on ISS
 - Next Step-2
- Inflatable Airlock
 - Next Step-2
 - Gateway
- Deep Space Station Module
 - Next Step-2
 - Gateway
- Inflatable Surface Module (Lunar or MARS)
- MARS Transits Module
 - TransHab

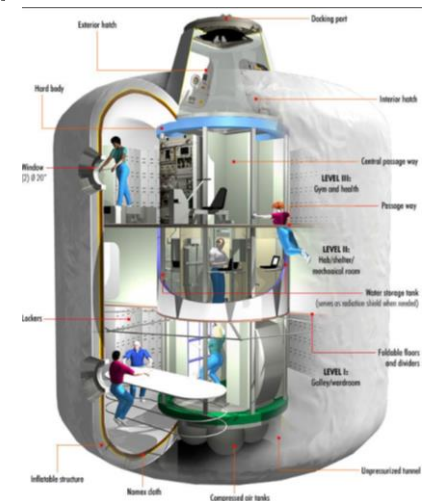
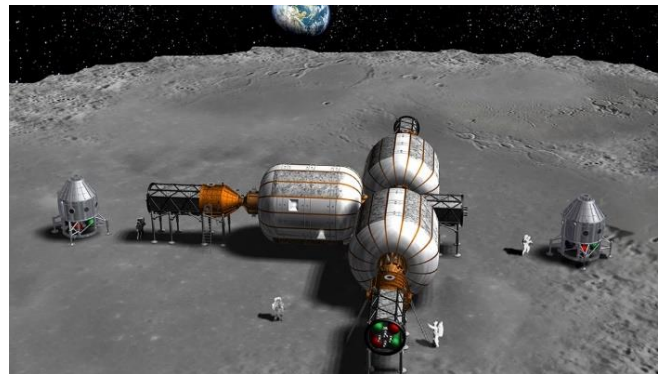



Team Acknowledgements



- ◆ The authors of this presentation would like to provide a special thanks to the entire BEAM project team and Bigelow Aerospace.

- ◆ Specifically the authors would like to acknowledge the following people who provided BEAM specific performance data:
 - Microbial Monitoring Performance – Ariel Macatangay, William Misek & Melanie Smith
 - Deployment Dynamics & Modal Test Results – Michael Grygier
 - Thermal Performance – John Iovine, Dr. William Walker, and Zaida Hernandez
 - MM/OD Monitoring Performance – Dr. Eric Madaras
 - Radiation Sensor System & Performance – Dr. Dan Fry and the entire Space Radiation Analysis Group (SRAG)



Backup



1. Lower launch/ascent volume relative to metallic modules

- Pro: Reduced size, drag and mass of the launch vehicle (or fairing), or more cargo inside the same fairing
- Con: Increased complexity for deployment and internal outfitting

BEAM	Packed	Inflated	Inflated/Packed Ratio
Mass (w/ PCBM & FSE)	~1400 kg (~3K lb)		1.0
Volume	3.6 m³	16 m³	4.4
Length (w/ FRGF)	2.16 m	4.01 m	1.9
Diameter	2.36 m	3.23 m	1.4
Pressure	0	14.7 psi	-

Key benefit of inflatables: launch small, then get big in space or on the surface of the moon or Mars





Why Expandables? (2/2)



2. Less mass for the same volume as metallic modules? Maybe.

- Depends upon mission and design requirements, outfitting, materials, size, etc.
- Current expandable module experience only at low volumes, not mass-optimized
- Small, mass-optimized metallic modules can be less dense than robust BEAM tech demo
- Large expandable module designs *potentially* offer lower density due to much greater specific strength of fabrics vs. metal alloys, though this must be proven in flight
- More experience with expandable modules may reduce mass due to reduced factor of safety (e.g., ISS requires FoS = 4.0 for fabric structures, 2.0 for aluminum)

Quick-Look Module Density Comparison

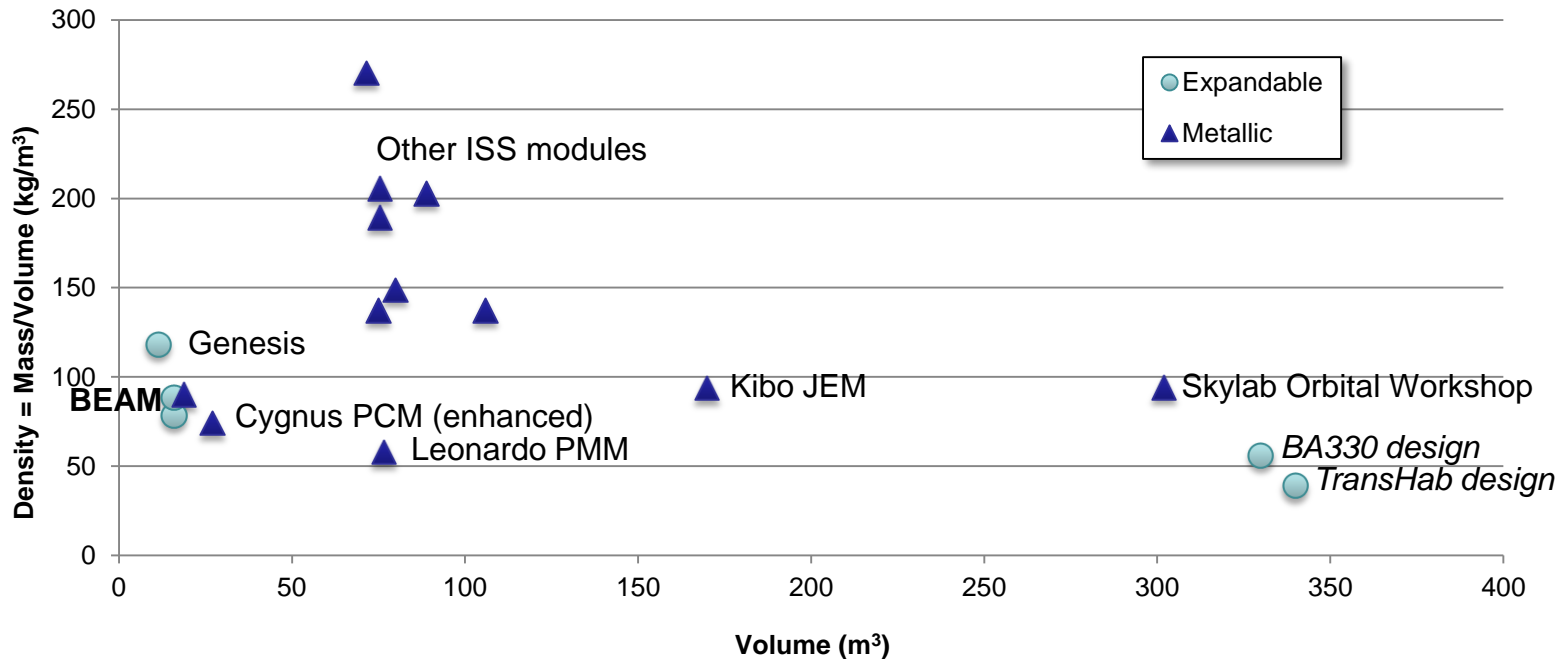

2016 WTS RESULTS (ALL SENSORS)

- Temperatures are recorded by the wireless temperature sensors (WTS) in sixteen locations
- Data below represents the first year of the BEAM mission
 - Data points are recorded every minute at each location and data sets are downloaded from ISS on monthly increments

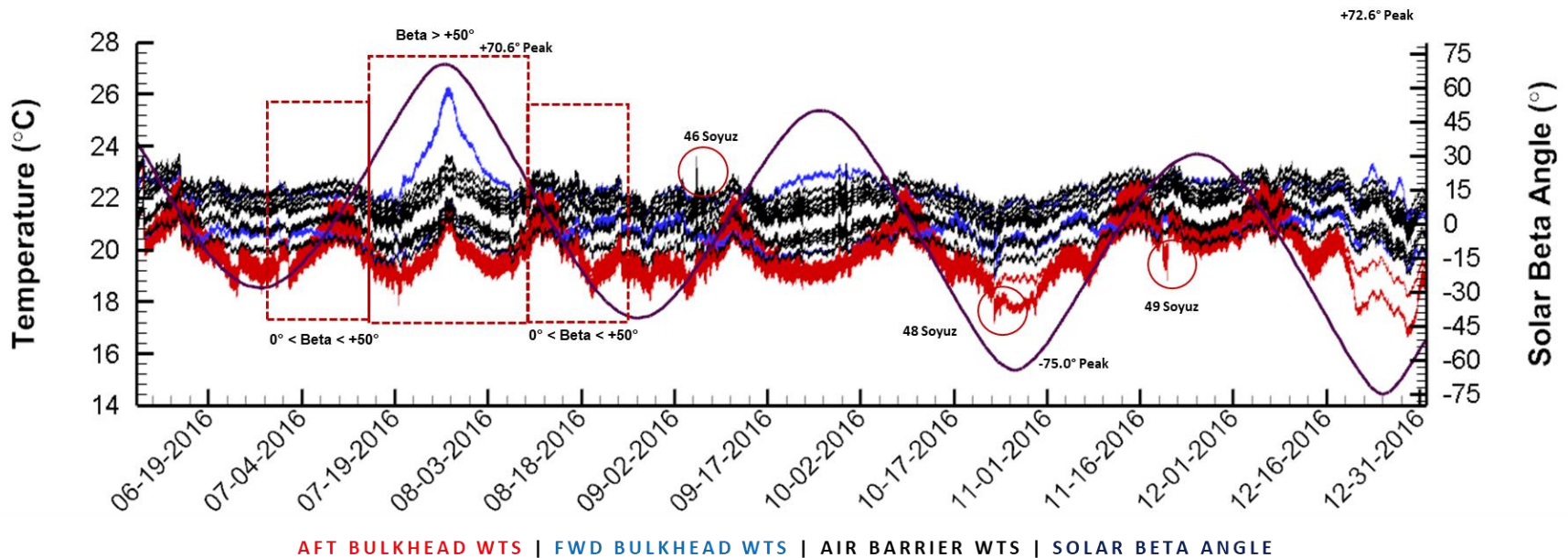
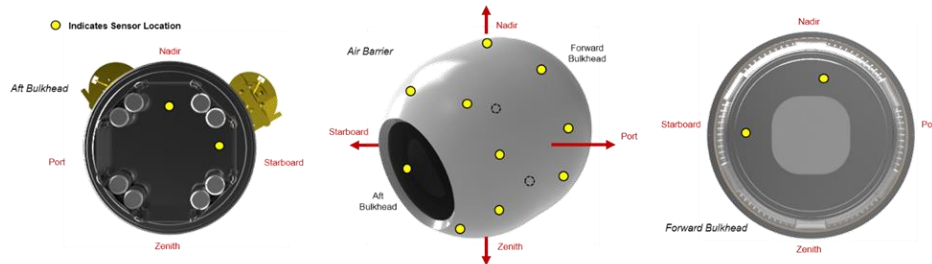



BEAM internal WTS Temperature measurements



2017 WTS RESULTS (ALL SENSORS)

- Data below represents the BEAM mission in 2017

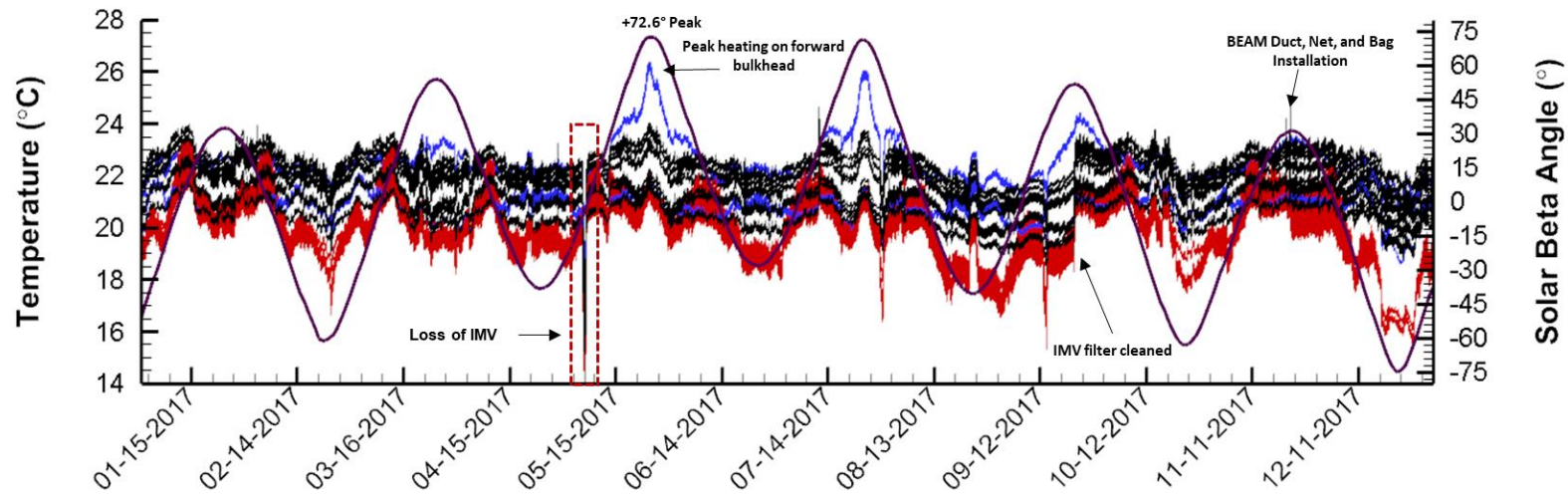
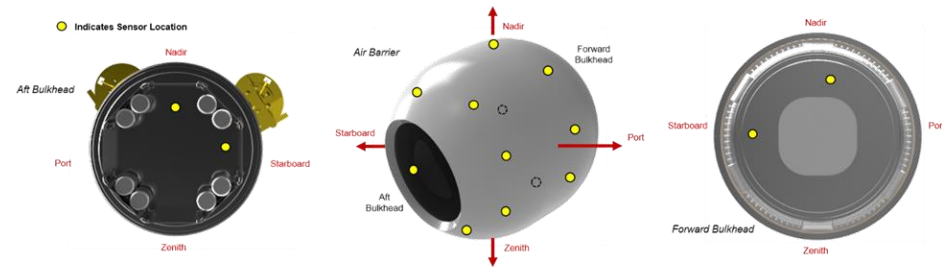

AFT BULKHEAD WTS | FWD BULKHEAD WTS | AIR BARRIER WTS | SOLAR BETA ANGLE



BEAM internal WTS Temperature measurements



2018 WTS RESULTS (ALL SENSORS)

- Data below represents BEAM mission in 2018 (with the life extension)

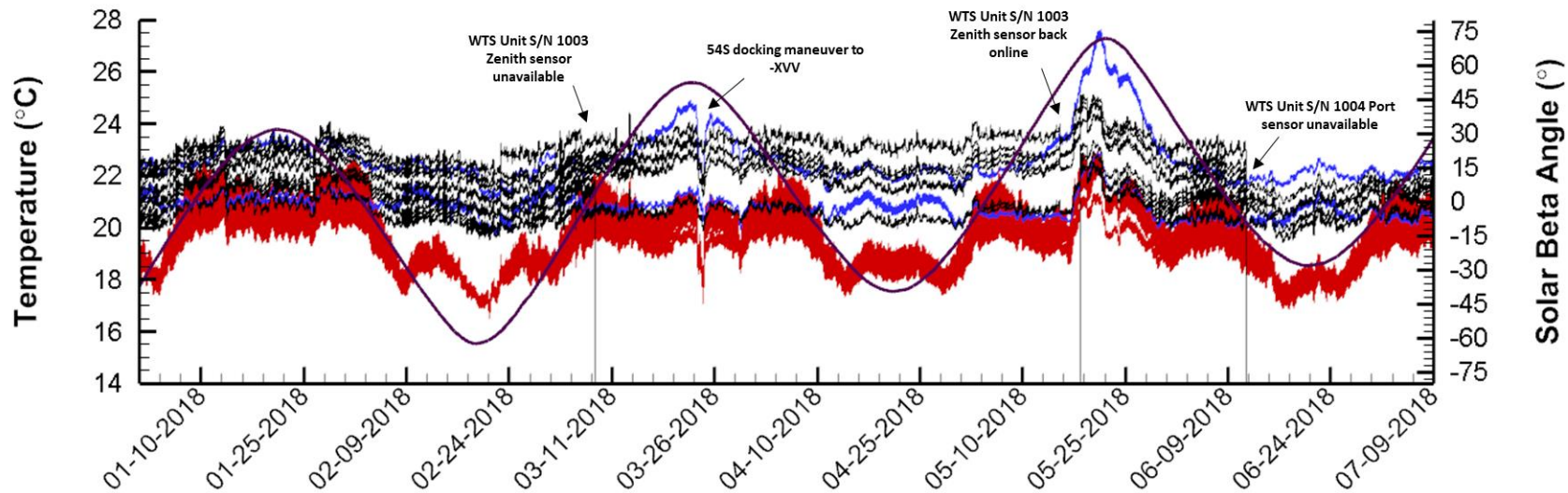
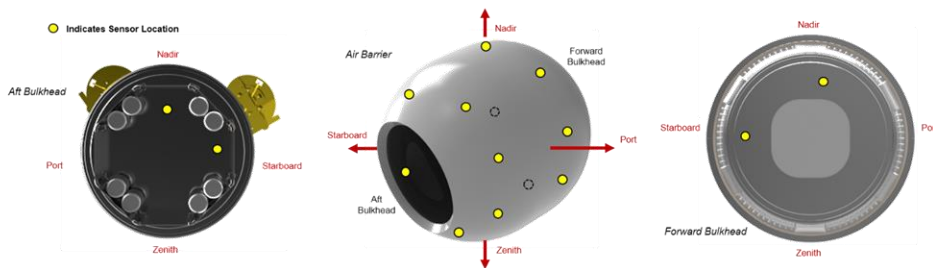

AFT BULKHEAD WTS | FWD BULKHEAD WTS | AIR BARRIER WTS | SOLAR BETA ANGLE



BEAM Impact Detection Performance Overview

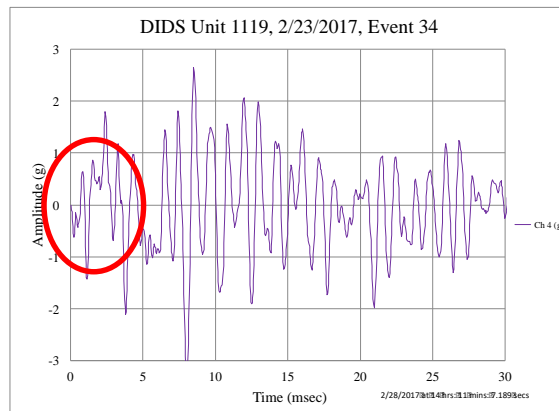
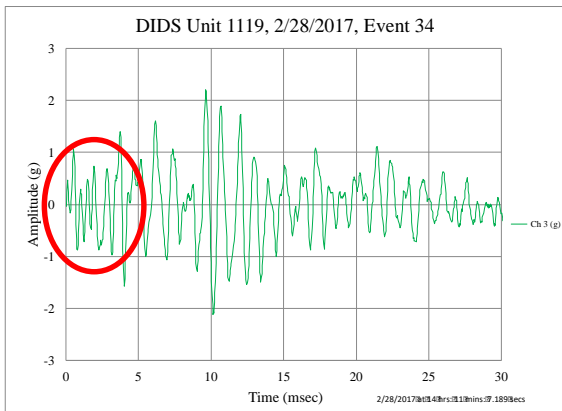
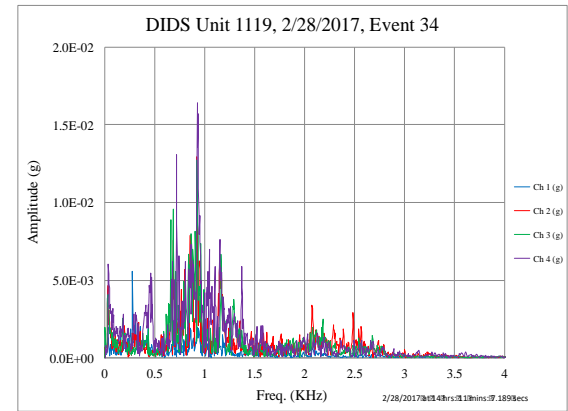
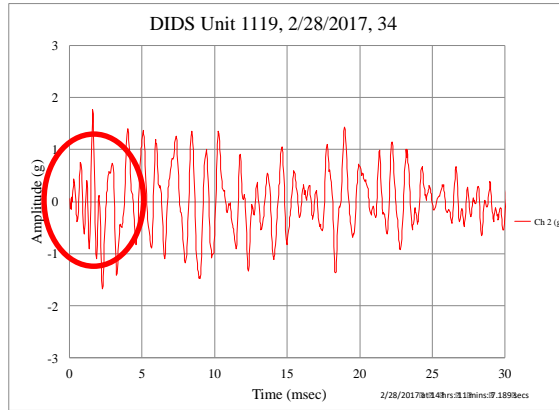
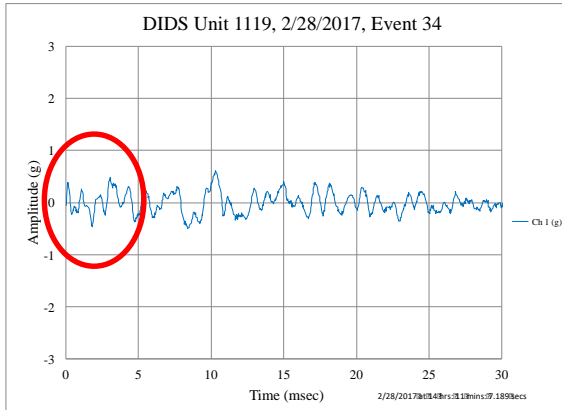

Zenith DIDS Frequency Response

Zenith DIDS Time History (all 4 channels)