



---

Commercial Crew Program  
John F. Kennedy Space Center

CCT-REQ-1130  
Revision: F

# ISS Crew Transportation and Services Requirements Document

*Original signed by*  
\_\_\_\_\_  
Kathryn L. Lueders  
Manager, Commercial Crew Program

September 6, 2017  
\_\_\_\_\_  
Date

## Record of Revision/Changes

Revision	Description	Date
<b>F</b>	CR 0276 – Updated JSC 22538, Flight Crew Health Stabilization Program (HSP) to Revision E. Additional changes to 4.3.4.2.7 and 4.3.4.2.8 to specify ISS altitude range required for verification, and 3.4.2.6 rationale and verification to evaluate landing site availability during de-orbit waive-offs	9/6/2017
<b>E-1</b>	CR 0251 – Deleted 3.10.2.4 and 4.3.10.2.4	10/11/2016
<b>E</b>	CR 0251 – Updated Revision of NASA-STD-8719.14 from Rev Baseline w/ change 4 to Rev A w/ Change 1. Additional error corrections identified during CCtCap have been implemented.	10/5/2016
<b>D-1</b>	Export Control marking removed for STI	4/29/2015
<b>D</b>	CR 0196 - Limited set of changes primarily to change loss of crew value and verification in 3.2.1.1 such that it measures the design robustness to MMOD. Additional changes to the revision of applicable document that have been approved since CR 164 and design guideline errors found in appendices.  CR 0164 -Limited set of changes to capture selected standards updates, clarifications identified through iCap and CPC contracts and JPRCB direction to implement the full pressurized Cargo IRD.	3/23/2015
<b>C</b>	CR 0119 – Changes clarified and stabilized 1130 requirements; enabled more accurate proposals from the Commercial Partners; and incorporated changes required by ISS for post-landing operations.	11/12/2013
<b>B-2</b>	Corrected omissions of previously approved changes and added export control notation in footer.	8/22/2013
<b>B-1</b>	Updated Appendix A and B	7/19/2013
<b>B</b>	Changes per CCP CR0093	7/18/2013
<b>A-1</b>	Editorial changes per CCP CR0077.	1/15/2013
<b>A</b>	Verification and Requirement Updates per CCP CR0035.	8/3/2012
<b>Basic-1</b>	Editorial changes per CCP CR0032.	4/5/2012
<b>Basic</b>	Baselines <i>ISS Crew Transportation and Services Requirements Document</i> .	12/8/2011

## Table of Contents

<b>1.0</b>	<b>INTRODUCTION</b> .....	<b>5</b>
1.1	PURPOSE .....	7
1.2	SCOPE .....	7
1.3	PRECEDENCE.....	8
1.4	DELEGATION OF AUTHORITY .....	8
1.5	VERB APPLICATION AND DOCUMENT DETAIL .....	8
<b>2.0</b>	<b>DOCUMENTS</b> .....	<b>10</b>
2.1	APPLICABLE DOCUMENTS.....	11
2.2	REFERENCE DOCUMENTS.....	21
<b>3.0</b>	<b>ISS CREW TRANSPORTATION AND SERVICE REQUIREMENTS</b> .....	<b>25</b>
3.1	ISS DESTINATION SERVICES .....	25
3.2	SAFETY AND MISSION ASSURANCE.....	34
3.3	PRE-LAUNCH/ASCENT .....	46
3.4	ONORBIT .....	51
3.5	ENTRY/LANDING REQUIREMENTS.....	55
3.6	CREW HEALTH SUPPORT.....	63
3.7	COMMERCIAL VEHICLE CONTROL CENTER (CVCC) .....	64
3.8	SPACECRAFT .....	65
3.9	SPACECRAFT AND LAUNCH VEHICLE DESIGN MANUFACTURING STANDARDS .....	71
3.10	HUMAN HEALTH, MEDICAL AND PERFORMANCE.....	78
3.11	GROUND SUPPORT EQUIPMENT (GSE).....	109
<b>4.0</b>	<b>TEST AND VERIFICATION</b> .....	<b>110</b>
4.1	GENERAL .....	110
4.2	QUALIFICATION AND ACCEPTANCE TEST REQUIREMENTS.....	112
4.3	ISS CREW TRANSPORTATION AND SERVICE REQUIREMENTS.....	113
4.3.1	ISS DESTINATION SERVICES .....	113
4.3.2	SAFETY AND MISSION ASSURANCE.....	120
4.3.3	PRE-LAUNCH/ASCENT .....	128
4.3.4	ONORBIT .....	131
4.3.5	ENTRY/LANDING REQUIREMENTS.....	134
4.3.6	CREW HEALTH SUPPORT.....	140
4.3.7	COMMERCIAL VEHICLE CONTROL CENTER (CVCC) .....	140
4.3.8	SPACECRAFT .....	141
4.3.9	SPACECRAFT AND LAUNCH VEHICLE DESIGN MANUFACTURING STANDARDS .....	147
4.3.10	HUMAN HEALTH, MEDICAL AND PERFORMANCE.....	154
4.3.11	GROUND SUPPORT EQUIPMENT (GSE).....	175
<b>APPENDIX A:</b>	<b>ACRONYMS</b> .....	<b>176</b>
<b>APPENDIX B:</b>	<b>1100 SERIES DEFINITIONS</b> .....	<b>180</b>
<b>APPENDIX C:</b>	<b>TBC/TBD/TBR/TBS TABLES</b> .....	<b>191</b>
<b>APPENDIX D:</b>	<b>CREW PHYSICAL DIMENSION AND MASS DESIGN DATA</b> .....	<b>192</b>
<b>APPENDIX E:</b>	<b>CREWMEMBER STRENGTH DATA</b> .....	<b>198</b>
<b>APPENDIX F:</b>	<b>METABOLIC LOADS</b> .....	<b>220</b>
<b>APPENDIX G:</b>	<b>FOOD AND POTABLE WATER</b> .....	<b>223</b>
<b>APPENDIX H:</b>	<b>ACCELERATION LIMITS ACCELERATION COORDINATE SYSTEM</b> .....	<b>225</b>
<b>APPENDIX I:</b>	<b>RADIATION</b> .....	<b>232</b>

<b>APPENDIX J:</b>	<b>REFERENCE NASA-PROVIDED SUPPLIES .....</b>	<b>238</b>
<b>APPENDIX K:</b>	<b>CREW RANGE OF MOTION.....</b>	<b>241</b>
<b>APPENDIX L:</b>	<b>CREW INTERFACES .....</b>	<b>252</b>
<b>APPENDIX M:</b>	<b>RESERVED .....</b>	<b>257</b>
<b>APPENDIX N:</b>	<b>RESERVED .....</b>	<b>258</b>
<b>APPENDIX O:</b>	<b>RESERVED .....</b>	<b>259</b>
<b>APPENDIX P:</b>	<b>REFERENCE VEHICLE ENDURANCE TIMELINE .....</b>	<b>260</b>
<b>APPENDIX Q:</b>	<b>HUMAN SYSTEM INTERFACE DESIGN REQUIREMENTS.....</b>	<b>262</b>
Q.1:	CREW ENVIRONMENT .....	265
Q.2:	CREW HAZARD .....	271
Q.3:	CREW CONTROL INTERFACES .....	282
Q.4:	CREW TASK SUPPORT .....	287
Q.5:	HATCH AND WINDOW DESIGN .....	290
Q.6:	COMMUNICATION SYSTEM DESIGN.....	294

## 1.0 Introduction

Under the guidance of processes provided by *Crew Transportation Plan* (CCT-PLN-1100), this document with its sister documents, *Crew Transportation Technical Management Processes* (CCT-PLN-1120), *Crew Transportation Technical Standards and Design Evaluation Criteria* (CCT-STD-1140), and *Crew Transportation Operations Standards* (CCT-STD-1150), and *International Space Station (ISS) to Commercial Orbital Transportation Services Interface Requirements Document* (SSP 50808), provides the basis for a National Aeronautics and Space Administration (NASA) certification for services to the ISS for the Commercial Provider. When NASA Crew Transportation System (CTS) certification is achieved for ISS transportation, the Commercial Provider will be eligible to provide services to and from the ISS during the services phase of the NASA Commercial Crew Program (CCP).

The CTS has two top-level objectives in support of the NASA mission of providing services to the ISS. The primary objectives are to provide for crew rotation capability for four NASA or NASA-sponsored crewmembers, henceforth called NASA crew, and to provide for an emergency crew return capability for these crewmembers at any time while the commercial spacecraft is docked to the ISS. Secondary objectives include transporting a limited amount of ISS Program-specified pressurized cargo to the ISS, returning pressurized cargo from the ISS, and providing for a crew safe haven capability when the spacecraft is docked to the ISS. The Design Reference Mission (DRM) for ISS can also be found in CCT-DRM-1110.

The spacecraft will be capable of transporting NASA crew to the ISS and docking 24 hours after launch. Mission launch opportunities must be accomplished within NASA-specified timeframes to accommodate ongoing ISS science operations and to minimize ISS traffic model impacts associated with other visiting vehicles. Prior to launch, the CTS supports a NASA-provided pre-launch health stabilization program for NASA crew. The CTS also assures comparable health stabilization for any other crewmembers. Within a few hours of launch, NASA completes their crew medical assessments and baseline data collection process in NASA-provided facilities and hands the crew over to the CTS provider for transportation to the launch site. The NASA flight surgeons will serve as the physicians for the NASA crew during all phases of flight.

Lift-off occurs when the launch site passes through the ISS's orbital plane. Daily launch opportunities then depend on the resulting phasing; an everyday launch opportunity is desirable, but not required. Launch and ascent into the 51.6 degree inclination must meet Range Safety constraints associated with the launch site. Following ascent, an orbital insertion maneuver is executed and becomes the first of several orbital rendezvous maneuvers to be performed. These maneuvers bring the spacecraft closer towards the ISS. ISS standard communications are used when the spacecraft closes to within tens of kilometers to the ISS and ship-to-ship voice communications are established. Relative navigation is performed by the spacecraft using available cooperative and non-cooperative assets on the ISS. Communication and telemetry monitoring will be shared between the Commercial Vehicle Control Center (CVCC) and the ISS mission control facilities, Mission Control Center - Houston (MCC-H). MCC-H Mission Authority will be established to ensure ISS, spacecraft, and crew safety. When in close proximity to the ISS, after receiving approval from both the spacecraft and MCC-H, the spacecraft begins a final approach to a NASA-specified docking port on the ISS. After docking, the vestibule between the ISS and the spacecraft is pressurized and verified not to be leaking. The spacecraft hatches are opened and the crew transfers into the ISS, placing the newly arrived spacecraft in a quiescent state.

If the nominal docking attempt is not successful, or if an anomaly occurs near docking which would prevent docking at the nominal opportunity, the spacecraft backs out to a short safe distance and performs necessary reconfigurations, followed by a second approach and docking attempt. If that docking is also unsuccessful, the spacecraft will separate from the ISS vicinity on a collision-free safe trajectory and the spacecraft will prepare for a final re-rendezvous and docking attempt on the following crew day. If this final docking attempt is unsuccessful, the mission will be terminated, and the crew will return to Earth.

Because of the short time duration from launch to docking, internal maintenance of the spacecraft should not be necessary, nor should the crew require certain complex habitability items for food and waste management that can be found on longer duration vehicles, like the Space Shuttle or the ISS.

Extravehicular Activity (EVA) will not occur because the complexity of preparing for and executing an EVA is precluded due to the short time in the spacecraft early in the mission. Similarly, EVA will not be performed during the short free-flight duration from undocking to landing.

The spacecraft will be designed to be attached to the ISS for 210 days, although nominal crew rotations will occur at approximately 180-day intervals. The spacecraft remains quiescent and requires minimal maintenance during docked operations. The CVCC will provide routine, periodic support for these docked operations, in association with MCC-H. The ISS will provide power and environmental resources to the spacecraft in order to maintain the vehicle in a return-to-Earth ready state.

Due to limitations in the number of docking ports on the ISS, the spacecraft may need to be relocated from one docking port to another during ISS increment operations to provide operational flexibility. To accomplish this relocation, the spacecraft's full crew complement will ingress the spacecraft, close the hatch, and the spacecraft will be relocated from one port to the other port. The crew needs to be in the spacecraft to protect from the potential failure to re-mate with a docking port and preserve assured return for the crew.

When docked to the ISS, the spacecraft also provides a contingency "safe haven" capability allowing the crew to retreat to the spacecraft, close the hatch, and remain in a safe environment for up to 24 hours. If necessary, the spacecraft atmosphere will be purged during this activity. The ISS will provide attitude control during this 24-hour period. After the ISS returns to a habitable environment state, the crew will open the hatch and re-enter the ISS. If the ISS cannot achieve a habitable state during this period, the crew will return to Earth.

While docked to the ISS, the spacecraft will also serve as an emergency return vehicle for contingencies requiring the return of the crew brought to the ISS. Emergencies could result from ISS system failures, an uninhabitable crew environment, or a medical event requiring the return of the crewmembers. The crew will return to Earth within 24 hours of a declaration of an intention to return early. The crew will be fully trained to execute these contingency return-to-Earth operations, landing at a location where rescue is likely to be most expedient.

Due to the limited size and power available, the spacecraft is expected to have basic first aid and life support capability to respond to immediate medical conditions in the free-flight mode.

The launch of the next rotation mission may occur prior to the departure of the current increment crew working on the ISS, resulting in a handover period where two commercial spacecraft would be docked

to the ISS for approximately 7 to 10 days. If the Commercial Provider has received NASA approval to fly non-NASA crew to the ISS, the spacecraft will need to provide food, water, clothing, Environmental Control and Life Support System (ECLSS) consumables, and other logistics for these crewmembers for the docked timeframe, since NASA does not generally pre-position these supplies on the ISS.

After handover is complete, the current increment crew will return in the spacecraft. They will enter the spacecraft, perform a vehicle health check, close hatches, depress the vestibule, perform a hatch leak check to verify seal integrity, and depart from the ISS. When available consumables permit, the spacecraft will potentially circumnavigate the ISS while in proximity to assess the external configuration of the ISS prior to final departure. During this circumnavigation, the crew will capture imagery to allow post-flight analysis of the ISS configuration.

The timeframe from undocking through landing is envisioned to be a short 4 to 8 hour free-flight duration. Landing will occur on the continental United States (U.S.) land mass or waters directly extending from the coast for nominal landing. This reduces risk by minimizing rescue force assets, increasing proximity to U.S. medical facilities, increasing security, and ensuring a prepared landing site free of hazards. If the nominal deorbit maneuver is waived-off after separation from the ISS, a subsequent landing at an alternate landing site, with nearby recovery forces, will be possible. The spacecraft may also perform orbital maneuvers in low Earth orbit (LEO) to better accommodate alternate landing sites. Returning crew will be deconditioned and potentially have impaired musculoskeletal, cardiopulmonary, and neurovestibular capabilities as a result of long duration exposure to the micro-gravity and space environment, resulting in degraded crewmember performance in the post-landing timeframe. Because of the deconditioned state of the crew, special considerations need to be provided for crew recovery, medical care, and other post-landing care activities.

Upon arrival at the landing location, the NASA crew will be met with a recovery crew that will assist the astronauts in egress operations and removal of time-critical cargo. NASA personnel will begin post-flight medical and science evaluations soon after egress is complete in a temporary facility at the landing location. Subsequently, the NASA flight crew, NASA support personnel, and time-critical cargo will be transported by a CTS element to a staging location where handover will be completed and the NASA crew and cargo will be flown back to Houston using NASA assets.

After recovery operations are complete, the spacecraft will be safed and transported to a location for subsequent post-flight evaluation.

## **1.1 Purpose**

The purpose of this document, hereafter referred to as CCT-REQ-1130, is to provide the requirements for development (design, manufacturing, testing, qualification, production, and operation) of commercial services to deliver NASA crew and limited cargo to and from the ISS. The intent of this document is that all CTS requirements are to be fulfilled by the Commercial Provider; however, it may be more practical for NASA to provide the consumables or hardware associated with a particular function. This document clearly states when a function or hardware is the responsibility of NASA.

## **1.2 Scope**

These services and design requirements were developed by the CCP and the ISS Program for the crew transportation system. This document is clearly divided into ISS destination services requirements in Section 3.1 and transportation certification requirements in Sections 3.2 through 3.11.

The CTS refers to all assets and services required to meet the requirements of CCT-REQ-1130, including pre-flight planning, trajectory and abort analysis, ground processing and manufacturing, ground operations, mission control, training, launch control, post-landing recovery operations, safety and mission assurance, and all other functions required for safe and successful human space flight missions. Other key definitions include integrated space vehicle, which will be used when discussing the launch vehicle and spacecraft. The spacecraft is also known as the “crewed element” and serves as the crew rescue or crew transfer vehicle, while the “launch vehicle” is the element that provides the propulsion systems necessary to transport the spacecraft to the desired insertion orbit. Another term that is utilized throughout this document is NASA crew, which consists of all crewmembers sponsored by NASA, including both International Partners (IP) and NASA astronauts.

### 1.3 Precedence

In the event of a conflict between the text of this document and references cited herein (listed in Section 2.0), the text of this document takes precedence. The exception to this statement is for SSP 50808, which takes precedence during ISS integrated operations. Nothing in this document supersedes applicable laws and regulations unless a specific exemption has been obtained.

In the event of conflict between this document and any spreadsheet exports of the NASA requirements database, the contents of this document take precedence.

### 1.4 Delegation of Authority

This document was jointly prepared by and will be jointly managed by the CCP and the ISS Program. The Joint Program Requirements Control Board (JPRCB) is the authority for baselining and approving changes to this document. CCT-REQ-1130 will be maintained in accordance with standards for the CCP documentation. The CCP is responsible for assuring the definition, control, implementation, and verification of the requirements identified in this document. Coordination with the ISS Program for verification and eventual certification of the requirements identified as ISS driven requirements will be performed through the CCP.

### 1.5 Verb Application and Document Detail

When used within the context of a requirement under a contract, statements in this document containing *shall* are used for binding requirements that must be verified and have an accompanying method of verification; *will* is used as a statement of fact, declaration of purpose, or expected occurrence; and *should* denotes an attribute or best practice which must be addressed by the system design. When used within the context of a reference document under an agreement, the verbs *shall*, *will*, and *should* are only intended as informational and are not binding.

In some cases, the values of quantities included in this document have not been confirmed and are designated as: “To Be Confirmed” (TBC) - still under evaluation, and “To Be Determined” (TBD) or “To Be Supplied” (TBS) - known, but not yet available. A “To Be Resolved” (TBR) is used when there is a disagreement on the requirement between technical teams. When a change in a noted characteristic is deemed appropriate, notification of the change shall be sent to the appropriate review and change control authority.

Each requirement in CCT-REQ-1130 is annotated by its section number. At the end of each requirement text is a requirement ID of the format R.CTS. This corresponds to the absolute ID in



NASA's requirements database. It can be used to cross reference requirements in this document to spreadsheet exports of the database. See Section 1.3 in the event of conflict between this document and spreadsheet exports.

## 2.0 Documents

The following design, manufacturing, testing, and quality control standards apply to all space flight hardware and software, including the launch vehicle, all portions of the spacecraft, and any launch abort system. There are also specific standards for ground support equipment (GSE), along with software standards for ground software that are needed to perform a primary mission objective, have direct interaction with human space flight systems, or have a direct impact on the health and safety of the crew.

NASA has identified three basic types of standards:

1. One type of standard must be followed completely with no deviation or alternative proposal. They are identified by the words “**meet**” within the corresponding sections of this document. Within the Applicable Documents list below these standards will be shown as fully applicable. Verification language for these technical standards that must be met can be found in Section 4.0 of this document. Any Applicable Document listed within these “**meet**” documents are considered to be “**meet the intent of**” documents and alternative standards can be proposed.
2. The majority of the standards identified are standards which use the language “**meet the intent of.**” These contain requirements that can be met explicitly by following the standard or by proposing alternate standards that meet or are consistent with the requirement levied in the NASA Standard. It should be understood that the applicable documents called out by “**meet the intent of**” standards from CCT-REQ-1130 are also considered “**meet the intent of**” standards. Within the Applicable Documents list below these standards will be shown as “Alternative Allowed.” Because these standards are unique, CCT-STD-1140 was developed to define some specific criteria utilized by NASA to evaluate and approve alternative standards. The process and product defined in the respective sections of CCT-STD-1140 define the details of how any proposed alternative standards will be evaluated along with the key aspects of items proposed as part of the verification. The Requirements Applicability Matrix in Section 2.1 of CCT-STD-1140 provides a mapping of the sections that discuss the details of each standard where an alternative is allowed. The specific verification language for each of these alternative standards will be partnered with NASA after an agreement is reached on the alternative standard. Verification language for these technical standards that must be met or complied with can be found in Section 4.0 of this document. Similar to Engineering Standards, Human System Integration Design Requirements are listed in Appendix Q and are invoked by the “**meet the intent**” requirement 3.10.1. Alternatives to the children requirements in Appendix Q can be proposed.
3. There are many other standards that may be utilized in the design and manufacturing process and for standard operations. These are the third type of NASA standard and many of these documents can be found in the reference documents in Section 2.2. These technical standards are reference and will have no verification language attached. CCT-STD-1150 was developed to define specific criteria for operations spanning the interval from integrated vehicle assembly, test, and integration at the launch site through recovery of NASA crew and cargo at the landing site(s). The products and processes defined in the respective sections of CCT-STD-1150 discuss in detail how operational standards will be evaluated.

## 2.1 Applicable Documents

Document Number	Revision	Title	CCT-REQ-1130 Location	Applicability	Alternative Documents (Allowed/Not Allowed)
<b>ANSI S3.2-2009</b>	2009	<i>American National Standard Method for Measuring the Intelligibility of Speech over Communicating System</i>	3.10.4.8, 4.3.10.4.8, Q.6.3, Q.6.3V	ALL	Not Allowed for 3.10.4.8, 4.3.10.4.8, Allowed for Q.6.3, Q.6.3V
<b>ANSI Z136.1-2007</b>	BL (1/1/07)	<i>The American National Standard for Safe Use of Lasers</i>	3.10.6.3.2, 4.3.10.6.3.2	ALL	Not Allowed
<b>ANSI/ESD S20.20</b>	Edition 07 (6/19/08)	<i>For the Development of an Electrostatic Discharge Control Program for - Protection of Electrical and Electronic Parts, Assemblies and Equipment (Excluding Electrically Initiated Explosive Devices)</i>	3.9.3.13.2, 4.3.9.3.13.2	ALL	Allowed
<b>EPA Method 524.2</b>	4.1	<i>Measurement of Purgeable Organic Compounds in Water by Capillary Column Gas Chromatography/Mass Spectrometry</i>	Appendix G, Table G-1	ALL	Not Allowed
<b>EPA Method 625</b>	2000	<i>Methods for Organic Chemical Analysis of Municipal and Industrial Wastewater, Base Neutrals and Acids</i>	Appendix G, Table G-1	ALL	Not Allowed

<b>Document Number</b>	<b>Revision</b>	<b>Title</b>	<b>CCT-REQ-1130 Location</b>	<b>Applicability</b>	<b>Alternative Documents (Allowed/Not Allowed)</b>
<b>FAA AC 20-136B</b>	BL (9/7/11)	<i>Protection of Aircraft Electrical/Electronic Systems Against the Indirect Effects of Lightning</i>	3.9.3.17.1, 4.3.9.3.17.1	ALL	Allowed
<b>Federal Information Processing Standard (FIPS) Publication 197</b>	BL (11/26/01)	<i>Advanced Encryption Standard (AES)</i>	3.8.2.1, 4.3.8.2.1	ALL	Not Allowed
<b>FIPS Publication 140-2</b>	BL (5/25/01) with change 2, 3, and 4 12/2002	<i>Security Requirements for Cryptographic Modules, Level 2 Certification</i>	3.8.2.2, 4.3.8.2.2	ALL	Not Allowed
<b>GEIA-STD-0005-1</b>	BL (6/1/06)	<i>Performance Standard for Aerospace and High Performance Electronic Systems Containing Lead-Free Solder</i>	3.9.3.7.3, 4.3.9.3.7.3	ALL	Allowed
<b>GEIA-STD-0005-2</b>	BL (6/1/06)	<i>Standard for Mitigating the Effects of Tin Whiskers in Aerospace and High Performance Electronics</i>	3.9.3.7.4, 4.3.9.3.7.4	ALL	Allowed

<b>Document Number</b>	<b>Revision</b>	<b>Title</b>	<b>CCT-REQ-1130 Location</b>	<b>Applicability</b>	<b>Alternative Documents (Allowed/Not Allowed)</b>
<b>IEC 61000-4-2</b>	Edition 2.0	<i>Electromagnetic Compatibility (EMC) Testing and Measurement Techniques- Electrostatic Discharge Immunity Test for Human Body Model (HBM) subassemblies, assemblies and equipment discharge levels</i>	3.9.3.13.3, 4.3.9.3.13.3	ALL	Allowed
<b>IPC-2152</b>	BL (8/1/09)	<i>Standard for Determining Current Carrying Capacity in Printed circuit Board Design</i>	3.9.3.3.3, 4.3.9.3.3.3	ALL	Allowed
<b>IPC-2220 Series</b>	2221: A 2222: A 2223: B 2224: BL 2225: BL 2226: BL	<i>Family of Printed Board Performance Documents</i>	3.9.3.3.1, 4.3.9.3.3.1	ALL	Allowed
<b>IPC-6010 Series</b>	6011: BL 6012: C 6013: B 6015: BL 6016: BL 6017: BL 6018: A	<i>Family of Printed Board Performance Documents</i>	3.9.3.3.2, 4.3.9.3.3.2	ALL	Allowed
<b>IPC-CM-770E</b>	E (1/1/04)	<i>Component Mounting Guidelines for Printed Boards</i>	3.9.3.12.2, 4.3.9.3.12.2	ALL	Allowed
<b>IPC J-STD-001E</b>	E	<i>Requirements for Soldered Electrical and Electronic Assemblies</i>	3.9.3.7.1, 4.3.9.3.7.1	ALL	Allowed

<b>Document Number</b>	<b>Revision</b>	<b>Title</b>	<b>CCT-REQ-1130 Location</b>	<b>Applicability</b>	<b>Alternative Documents (Allowed/Not Allowed)</b>
<b>IPC J-STD-001ES Amendment 1</b>		<i>Space Applications Electronic Hardware Addendum to J-STD 001E, Requirements for Soldered Electrical and Electronic Assemblies</i>	3.9.3.7.1, 4.3.9.3.7.1	ALL	Allowed
<b>ISBN 0875530478</b>	2005	<i>American Public Health Association, Standard Methods for Examination of Water &amp; Wastewater</i>	4.3.10.19.1, 4.3.10.19.2	ALL	Not Allowed
<b>ISO 2631-1:1997</b>		<i>Mechanical Vibration and Shock - Evaluation of Human Exposure to Whole-Body Vibration</i>	4.3.10.2.6	ALL	Not Allowed
<b>ISO 7731:2003</b>	E	<i>Ergonomics – Danger signals for public work areas Auditory danger signals</i>	Appendix Q, Q.6.2, Q.6.2V	Only Sections 4.2.2.2 and 5.2.2.1 are applicable	Allowed
<b>JSC 20584</b>	BL (11/08)	<i>Spacecraft Maximum Allowable Concentrations for Airborne Contaminants</i>	3.2.5.2, 3.10.11.1.3, 3.10.12.3, 4.3.2.5.2, 4.3.10.11.1.3 , 4.3.10.12.3, Appendix Q	ALL	Not Allowed for 3.2.5.2, 3.10.11.1.3, 3.10.12.3, 4.3.2.5.2, 4.3.10.11.1.3, 4.3.10.12.3, Allowed for Appendix Q
<b>JSC 20793</b>	C	<i>Crewed Space Vehicle Battery Safety Requirements (3.9.3.11.1)</i>	3.9.3.11.1, 4.3.9.3.11.1	ALL	Allowed
<b>JSC 22538</b>	E	<i>Flight Crew Health Stabilization Program</i>	3.6.4, 4.3.6.4	ALL	Not Allowed

<b>Document Number</b>	<b>Revision</b>	<b>Title</b>	<b>CCT-REQ-1130 Location</b>	<b>Applicability</b>	<b>Alternative Documents (Allowed/Not Allowed)</b>
<b>JSC 26895</b>	BL (10/97)	<i>Guidelines for Assessing the Toxic Hazard of Spacecraft Chemicals and Test Materials</i>	3.10.12.2	ALL	Not Allowed
<b>JSC 62809</b>	D	<i>Human Rated Spacecraft Pyrotechnic Specification</i>	3.9.7.1, 4.3.9.7.1	ALL	Allowed
<b>JSC 63414</b>	BL (11/08)	<i>Spacecraft Water Exposure Guidelines (SWEG)</i>	Appendix G, Table G-1	ALL	Not Allowed
<b>JSC 65827</b>	A	<i>Thermal Protection System Design Standard for Spacecraft</i>	3.9.6.1, 4.3.9.6.1	ALL	Allowed
<b>JSC 65828</b>	B-1	<i>Structural Design Requirements and Factors of Safety for Spaceflight Hardware</i>	3.9.8.1.1, 4.3.9.8.1.1,	ALL	Allowed
<b>JSC 65829</b>	A	<i>Loads and Structural Dynamics Requirements for Spaceflight Hardware</i>	3.9.8.2.1, 4.3.9.8.2.1, Appendix E	ALL	Allowed
<b>JSC 65985</b>	A	<i>Requirements for Human Spaceflight for the Trailing Deployable Aerodynamic Decelerator (TDAD)</i>	3.9.4.1.1, 4.3.9.4.1.1	ALL	Allowed
<b>JSC 66320</b>	A	<i>Optical Property Requirements for Glasses, Ceramics, and Plastics in Spacecraft Window Systems</i>	Q.5.8, Q.5.8V, 3.1.5.4, 4.3.1.5.4	ALL	Not Allowed for 3.1.5.4; Allowed for Q.5.8

<b>Document Number</b>	<b>Revision</b>	<b>Title</b>	<b>CCT-REQ-1130 Location</b>	<b>Applicability</b>	<b>Alternative Documents (Allowed/Not Allowed)</b>
<b>MIL-STD-461</b>	F	<i>Requirements for the Control of Electromagnetic Interference Characteristics of Subsystems and Equipment</i>	3.9.3.14.1, 4.3.9.3.14.1	ALL	Allowed
<b>MIL-STD-464</b>	C	<i>Electromagnetic Environmental Effects Requirements for Systems</i>	3.9.3.15.1, 4.3.9.3.15.1	ALL	Allowed
<b>MIL-STD-981</b>	C (7/1/10)	<i>Design, Manufacturing and Quality Standards for Custom Electromagnetic Devices for Space Applications</i>	3.9.3.16.1, 4.3.9.16.3.1	ALL	Allowed
<b>MSFC-DWG-20M02540</b>	E (1/15/92)	<i>Assessment of Flexible Lines for Flow-Induced Vibration</i>	3.9.9.1, 4.3.9.9.1	ALL	Allowed
<b>MSFC-SPEC-626</b>	Basic (5/11/90)	<i>Test Control Document for Assessment of Flexible Lines for Flow Induced Vibration</i>	3.9.9.1, 4.3.9.9.1	ALL	Allowed
<b>NASA-STD-4003</b>	A (2/5/13)	<i>Electrical Bonding For NASA Launch Vehicles, Spacecraft, Payloads, And Flight Equipment</i>	3.9.3.10.1, 4.3.9.3.10.1, Q2.6V	ALL	Allowed
<b>NASA-STD-4005</b>	BL (6/3/07)	<i>Low Earth Orbit Spacecraft Charging Design Standard</i>	3.9.3.13.1, 4.3.9.3.13.1	ALL	Allowed
<b>NASA-STD-5012</b>	A (1/16/15)	<i>Strength and Life Assessment Requirements for Liquid Fueled Space Propulsion System Engines</i>	3.9.10.1, 4.3.9.10.1	ALL	Allowed



<b>Document Number</b>	<b>Revision</b>	<b>Title</b>	<b>CCT-REQ-1130 Location</b>	<b>Applicability</b>	<b>Alternative Documents (Allowed/Not Allowed)</b>
<b>NASA-STD-5017</b>	BL	<i>Design and Development Requirements for Mechanisms</i>	3.9.5.1, 3.10.16.3, 4.3.9.5.1, Appendix E	Sections 4.7 and 4.8.9 are not applicable	Allowed
<b>NASA-STD-5018</b>	BL	<i>Strength Design and Verification Criteria for Glass, Ceramics, and Windows in Human Spaceflight Applications</i>	3.9.8.1.2, 4.3.9.8.1.2	Sections 4.6.3, 5.6.3, 4.10.2 and 5.10.2 are not applicable	Allowed
<b>NASA-STD-5019</b>	BL (1/7/08)	<i>Fracture Control Requirements For Spaceflight Hardware</i>	3.9.11.1, 4.3.9.11.1	ALL	Allowed
<b>NASA-STD-5020</b>	BL (3/12/12)	<i>Requirements for Threaded Fastening Systems in Spaceflight Hardware</i>	3.9.8.3, 4.3.9.8.3	ALL	Allowed
<b>NASA-STD-6016</b>	BL (7/11/08)	<i>Standard Materials and Processes Requirements for Spacecraft</i>	3.9.1.1, 3.9.1.2, 4.3.9.1.1, 4.3.9.1.2	ALL	Allowed
<b>NASA-STD-7009</b>	BL (7/11/08)	<i>Standard for Models and Simulations</i>	3.9.14.1	4.1.1, 4.1.2, 4.7, 4.8	Allowed
<b>NASA-STD-8719.14</b>	A w/ change 1	<i>Process for Limiting Orbital Debris</i>	3.4.3.1, 4.3.4.3.1	ALL	Allowed
<b>NASA-STD-8739.1</b>	A w/ change 2 (3/29/11)	<i>Workmanship Standard for Polymeric Application on Electronic Assemblies</i>	3.9.3.6.1, 4.3.9.3.6.1	ALL	Allowed
<b>NASA-STD-8739.4</b>	BL w/ change 6	<i>Crimping, Interconnecting Cables, Harnesses, and Wiring</i>	3.9.3.8.1, 4.3.9.3.8.1	ALL	Allowed
<b>NASA-STD-8739.5</b>	BL w/ change 2	<i>Fiber Optic Terminations, Cable Assemblies, and Installation</i>	3.9.3.5.2, 4.3.9.3.5.2	ALL	Allowed

<b>Document Number</b>	<b>Revision</b>	<b>Title</b>	<b>CCT-REQ-1130 Location</b>	<b>Applicability</b>	<b>Alternative Documents (Allowed/Not Allowed)</b>
<b>National Council on Radiation Protection and Measurements (NCRP) Report Number 132</b>		<i>Radiation Protection Guidance for Activities in Low-Earth Orbit</i>	4.3.10.6.2.1	Tables 4.2 and 4.3	Not Allowed
<b>NPR 7150.2A</b>	A (11/19/09)	<i>NASA Software Engineering Requirements</i>	3.9.2.1, 4.3.9.2.1	ALL	Allowed
<b>NPR 8715.5</b>	A	<i>Range Flight Safety Program</i>	3.3.3.2, 4.3.3.3.2	ALL	Not Allowed
<b>National Institute of Standards and Technology (NIST) SP 800-57</b>	Part 1, Rev. 3 (7/12)	<i>Recommendation for Key Management – Part 1</i>	3.8.2.3, 4.3.8.2.3	ALL	Not Allowed
<b>SAE ARP 5412A</b>	A	<i>Aircraft Lightning Environment and Related Test Waveforms</i>	3.9.3.17.1, 4.3.9.3.17.1	ALL	Allowed
<b>SAE ARP 5414A</b>	A	<i>Aircraft Lightning Zoning</i>	3.9.3.17.1, 4.3.9.3.17.1	ALL	Allowed
<b>SAE ARP 5577</b>	Basic (9/1/02)	<i>Aircraft Lightning Direct Effects Certification</i>	3.9.3.17.1, 4.3.9.3.17.1	ALL	Allowed
<b>SAE-AS-7928</b>	B (3/1/11)	<i>General Specification for Terminals, Lug: Splices, Conductor: Crimp Style, Copper</i>	3.9.3.8.1, 4.3.9.3.8.1	ALL	Not Allowed
<b>SMC Standard SMC-S-010</b>	BL (1/12/09)	<i>Space and Missile Systems Center Standard, Parts, Materials, and Processes Technical Requirements for Space and Launch Vehicles</i>	3.9.12.1, 4.3.9.12.1	ALL	Allowed

<b>Document Number</b>	<b>Revision</b>	<b>Title</b>	<b>CCT-REQ-1130 Location</b>	<b>Applicability</b>	<b>Alternative Documents (Allowed/Not Allowed)</b>
<b>SMC Standard SMC-S-016 (2008)</b>	6/13/08	<i>Test Requirements for Launch, Upper-Stage, and Space Vehicles</i>	3.9.13.1, 4.2, 4.3.9.13.1	ALL	Allowed
<b>SSP 30512</b>	C (6/3/94)	<i>Space Station Ionizing Radiation Design Environment</i>	3.10.6.2.1, 4.3.10.6.2.1	ALL	Not Allowed
<b>SSP 41172</b>	AA	<i>Qualification and Acceptance Environmental Test Requirements</i>	4.3.10.12.3	5.4.2	Not Allowed
<b>SSP 42014</b>	B	<i>Crew Health System (CHeCS) to Lab Interface Control Document</i>	3.6.2, 4.3.6.2	Section 3.3.6.1, 3.3.6.1.1, 3.3.6.1.2	Not Allowed
<b>SSP 50005</b>	E	<i>International Space Station Flight Crew Integration Standard</i>	3.10.4.5, 4.3.10.4.5, Q.2.1, Q.2.IV, Q.3.6V	Sections 6.3.3.1, 6.3.3.2, 6.3.3.3, 6.3.3.4, 6.3.3.5, 6.3.3.8, 6.3.3.9, 6.3.3.11, 9.4.4.3, 9.5.3.2 ONLY	Not Allowed for 3.10.4.5, 4.3.10.4.5, Allowed for Q.2.1, Q.2.1V, Q.3.6V
<b>SSP 50808</b>	E	<i>International Space Station to Commercial Orbital Transportation Services Interface Requirements Document</i>	3.1.1.5, 3.1.3.4, 3.1.3.5, 3.1.5.3, 3.2.4.2, 3.4.2.5, 3.4.2.8, 3.8.1.5, 3.10.11.1.1, 3.10.12.9, 4.3.1.1.7, 4.3.1.2.2, 4.3.4.1.1, Appendix P	ALL	Not Allowed

Document Number	Revision	Title	CCT-REQ-1130 Location	Applicability	Alternative Documents (Allowed/Not Allowed)
SSP 50833	B (2/15)	<i>ISS Cargo Transport Requirements Document</i>	3.1.3.1, 4.3.1.3.1, 3.1.3.2, 4.3.1.3.2, 3.1.3.3, 4.3.1.3.3, 3.1.3.4, 4.3.1.3.4, 3.1.3.5, 4.3.1.3.5, 3.1.3.6, 4.3.1.3.6, 3.1.3.7, 4.3.1.3.7, 3.1.3.8, 4.3.1.3.8, 3.5.3.7, 4.3.5.3.7	Only Sections 3.1.1 and 3.1.2 are applicable	Not Allowed

## 2.2 Reference Documents

This section will provide a list of documents and technical and manufacturing standards that can be used as a reference during the launch vehicle, spacecraft, and ground system design activities. Additional reference documents for a variety of technical disciplines can be found in CCT-STD-1140.

<b>Document Number</b>	<b>Revision</b>	<b>Title</b>
<b>10 CFR 20.1003</b>		<i>Title 10 – Energy; Chapter I -- Nuclear Regulatory Commission; Part 20 -- Standards for Protection Against Radiation; Subpart A -- General Provisions</i>
<b>ACGIH TLVs and BEI (2007)</b>		<i>American Conference of Governmental Industrial Hygienists (ACGIH) standard, Threshold Limit Values® and Biological Exposure Indices®</i>
<b>AFSPCMAN 91-710</b>		<i>Air Force Space Command Range Safety User Requirements</i>
<b>AGARD-CP-472</b>		<i>Development of Acceleration Exposure Limits for Advanced Escape Systems (Brinkley, J.W.; Specker, L.J.; Armstrong, H.G.; Mosher, S.E. (February 1990). AGARD-CP-472. Implications of Advanced Technologies for Air and Spacecraft Escape.)</i>
<b>AIAA-S-114</b>		<i>Space Systems – Moving Mechanical Assemblies for Space and Launch Vehicles, January 1, 2005 (provided as reference)</i>
<b>ASTM Manual 36</b>		<i>Safe Use of Oxygen and Oxygen Systems: Guidelines for Oxygen System Design, Materials Selection, Operations, Storage, and Transportation</i>
<b>CXP 70023</b>		<i>Constellation Program Design Specifications for Natural Environments (DSNE)</i>
<b>CXP 70044</b>		<i>Constellation Program Natural Environment Definition for Design (NEDD);</i>
<b>EARD</b>		<i>Exploration Architecture Requirements Document</i>
<b>FAA HFDS</b>		<i>Human Factors Design Standard</i>
<b>GIDEP S0300-BT-PRO-010</b>		<i>Government-Industry Data Exchange (GIDEP) Operations Manual</i>
<b>GIDEP S0300-BU-GYD-010</b>		<i>Government-Industry Data Exchange (GIDEP) Requirements Guide</i>
<b>GSFC-STD-1000</b>		<i>Goddard Space Flight Center Rules for the Design, Development, Verification, and Operation of Flight Systems</i>
<b>HRP-47072</b>		<i>Risk of Orthostatic Intolerance During Re-exposure to Gravity</i>
<b>IEEE 730-2002</b>		<i>Institute of Electrical and Electronic Engineers (IEEE) Standard for Software Quality Assurance Plans</i>
<b>IEEE C95.1</b>		<i>Standard for Safety Levels with Respect to Human Exposure to Radio Frequency Electromagnetic Fields, 3 kHz to 300 GHz – Description</i>
<b>ISO 13407</b>		<i>Human-Centered Design Processes for Interactive Systems</i>

<b>ISO 6954-2000</b>		<i>Mechanical Vibration-Guidelines for the Measurement, Reporting, and Evaluation of Vibration with regard to Habitability on Passenger and Merchant Ships</i>
<b>JPR 8080.5</b>		<i>JSC Design and Procedural Standards</i>
<b>JSC 63828</b>		<i>Bio-Safety Review Board Operations and Requirements Document</i>
<b>JSC 64548</b>	BL	<i>Anthropometric and Strength Selection criteria for Astronaut Applicants</i>
<b>JSC 65993</b>		<i>Commercial Human Systems Integration Requirements</i>
<b>JSC 65994</b>		<i>Commercial Medical Operations Requirements Document</i>
<b>JSC 65995</b>		<i>Commercial Human System Integration Processes</i>
<b>KSC-DE-512</b>		<i>Facility, System, and Equipment General Design Requirements</i>
<b>KSC-NE-9439</b>		<i>KSC Design Engineering Handbook for Design and Development of Ground Systems</i>
<b>MIL-STD-1472F</b>	F	<i>Department of Defense Design Criteria Standard, Human Engineering</i>
<b>MIL-STD-1474</b>	D	<i>Department of Defense Design Criteria Standard, Noise Limits</i>
<b>NASA-HDBK-5010</b>	BL	<i>Fracture Control Implementation Handbook for Payloads, Experiments, and Similar Hardware</i>
<b>NASA-STD-3000 Volume I – II</b>		<i>Man-Systems Integration Standards</i>
<b>NASA-STD-3001 Volume 1</b>		<i>NASA Space Flight Human System Standard Volume 1: Crew Health</i>
<b>NASA-STD-3001 Volume 2</b>		<i>NASA Space Flight Human System Standard Volume 2: Human Factors, Habitability, and Environmental Health</i>
<b>NASA STD 2202-93</b>		<i>Software Formal Inspections Standard</i>
<b>NASA-STD-5002</b>		<i>Load Analyses of Spacecraft and Payloads</i>
<b>NASA-STD-5005</b>		<i>Standard for the Design and Fabrication of Ground Support Equipment (GSE)</i>
<b>NASA/SP-2007-6105</b>		<i>NASA Systems Engineering Handbook</i>
<b>NASA/SP-2008-565</b>		<i>Columbia Crew Survival Investigation Report</i>
<b>NASA/SP-2010-3407</b>	BL	<i>Human Integration Design Handbook</i>
<b>NASA/TM-2008-215633</b>		<i>Terrestrial Environment (Climatic) Criteria Guidelines for Use in Aerospace Vehicle Development</i>
<b>NASA TM-2013-217380</b>		<i>Application of the Brinkley Dynamic Response Model to Spacecraft Transient Events</i>
<b>NESC-RP-06-108/05-173-E</b>	E	<i>Design, Development Test and Evaluation (DDT&amp;E) Considerations for Safe and Reliable Human Rated Spacecraft Systems</i>
<b>Non-Government Document</b>	8 <sup>th</sup> Edition	<i>ACSM's Guidelines for Exercise Testing and Prescription, 8<sup>th</sup> Edition. 2000. Franklin BA, Whaley MH, Howley ET (eds). Philadelphia. Lippincott, Williams &amp; Wilkins.</i>

<b>Non-Government Document</b>		<i>Lockheed Engineering and Science, Computer Program Documentation 41-node Transient Metabolic Man Program, Lockheed Engineering and Sciences Company, Inc., 1989.</i>
<b>Non-Government Document</b>		<i>Jakob Nielsen, Usability Engineering, Morgan Kaufmann, Boston, 1993, ISBN 978-0125184069.</i>
<b>Non-Government Document</b>		<i>Stone, R. W., &amp; Letko, W. (1965) "Some observations on the stimulation of the vestibular system of man in a rotating environment," in NASA SP-77 "The Role of the Vestibular Organs in the Exploration of Space," pp. 263-278.</i>
<b>NPD 8700.1</b>	E	NASA Policy for Safety and Mission Success
<b>NPD 8700.3</b>	B	Safety and Mission Assurance (S&MA) Policy for NASA Spacecraft, Instruments, and Launch Services
<b>NPD 8710.5</b>	D	Policy for Pressure Vessels and Pressurized Systems
<b>NPD 8720.1</b>	C	NASA Reliability and Maintainability (R&M) Program Policy
<b>NPD 8730.1</b>	C	Metrology and Calibration
<b>NPD 8730.2</b>	C	NASA Parts Policy
<b>NPD 8730.5</b>	B	NASA Quality Assurance Program Policy
<b>NPD 8900.1</b>	G	Medical Operations Responsibilities in Support of Human Space Flight Programs
<b>NPD 8900.5</b>	A	NASA Health and Medical Policy for Human Space Exploration
<b>NPR 2810.1</b>	A	Security of Information Technology
<b>NPR 7120.5</b>	D	NASA Space Flight Program and Project Management Requirements
<b>NPR 7123.1</b>	A	NASA Systems Engineering Processes and Requirements
<b>NPR 8000.4</b>	A	Agency Risk Management Procedural Requirements
<b>NPR 8621.1</b>	B	NASA Procedural Requirements for Mishap and Close Call Reporting, Investigating, and Recordkeeping
<b>NPR 8705.2B</b>	B	NASA Human-Rating Requirements for Space Systems
<b>NPR 8705.5</b>	A	Technical Probabilistic Risk Assessment (PRA) Procedures for Safety and Mission Success for NASA Programs and Projects
<b>NPR 8715.3</b>	C	NASA General Safety Program Requirements
<b>NPR 8735.1</b>	B	Procedures for Exchanging Parts, Materials, and Safety Problem Data Utilizing the Government-Industry Data Exchange Program (GIDEP) and NASA Advisories
<b>NWC TP 6575</b>		Parachute Recovery System Design Manual
<b>RTCA DO-160E</b>	E	Environmental Conditions and Test Procedures for Airborne Equipment
<b>SAE ARP 5416</b>		Aircraft Lightning Test Methods
<b>SSP 30575</b>		Space Station Interior and Exterior Operational Location Coding System
<b>SSP 41000</b>		System Specifications for the ISS
<b>SSP 50200</b>		Station Program Implementation Plan Volume 9
<b>SSP 50260</b>		ISS Medical Operations Requirement Document
<b>SSP 50505</b>		Basic Provisions on Crew Actions in Case of Fire on the ISS
<b>SSP 50506</b>		Basic Guidelines for Crew Activities During ISS Depressurization

---

<b>SSP 50653-1</b>		Basic Provisions on Crew Actions in the Event of a Toxic Release on ISS
<b>SSP 57000</b>		Pressurized Payload Interface Requirements Document



## 3.0 ISS Crew Transportation and Service Requirements

### 3.1 ISS Destination Services

#### 3.1.1 Top Level System

##### 3.1.1.1 Launch Rate

The CTS shall be capable of at least two crewed launches to the ISS per year. [R.CTS.001] [I]

*Rationale: A normal ISS increment is 180 days, requiring a new replacement crew to be launched approximately two times per year.*

##### 3.1.1.2 Simultaneous Operation of Spacecraft

The CTS shall simultaneously operate two spacecraft, to allow an ISS NASA crew handover. [R.CTS.002] [I]

*Rationale: The launch of the next rotation mission may occur prior to the departure of the current increment crew working on the ISS, resulting in a direct crew handover period where two commercial spacecraft would be docked to the ISS for approximately 7 to 10 days. The communication infrastructure in the spacecraft, CVCC, network, and other required assets must be sized to accommodate two operational spacecraft (one docked and one in free-flight mode or both docked).*

##### 3.1.1.3 ISS Operations Impacts

The CTS shall not impact ISS operations due to real-time commanding, or active monitoring, during ISS docked operations, except for periodic vehicle maintenance as defined in requirement 3.8.3.1. [R.CTS.003] [I]

*Rationale: ISS crew time is reserved for science and other operations. The spacecraft design should not require commanding, active monitoring, and maintenance during quiescent docked operations to avoid impacts to the ISS crew science productivity. Additionally, this will reduce the overall burden on the ground infrastructure required to support this spacecraft while docked to the ISS. Periodic vehicle maintenance with a maximum crew impact is defined in requirement 3.8.3.1.*

##### 3.1.1.4 EVA Operations

The CTS shall complete the mission without requiring an EVA for nominal operations, contingency operations, or to perform maintenance activity. [R.CTS.004]

*Rationale: EVA will not occur because of the short time in the spacecraft early in the mission when the complexity of preparing for and executing an EVA precludes that activity. EVAs during the docked timeframe impact ISS crew time, consumables, and on-going science activities. Finally, the timeframe at the end of the flight is envisioned to be a short free-flight duration from undocking to landing, which precludes EVA.*

##### 3.1.1.5 Provide Supplies

The CTS shall provide all equipment, supplies, and consumables to support all crewmembers during any portion of the mission when the crew will occupy the spacecraft in a hatch-closed configuration. [R.CTS.005] [I]

*Rationale: Unless specifically noted in requirement 3.1.1.6 or SSP 50808, the CTS must provide all the supplies necessary for space flight to meet the functions described in CCT-REQ-1130.*

### **3.1.1.6 Transport NASA-Provided Supplies**

The spacecraft shall accommodate and utilize the NASA-provided supplies for NASA crew to include the following items: Environmental Health Kit, Food and Utensils, Contamination Cleanup Kit, Passive Radiation Area Monitors, Crew Personal Dosimeters, Medical Kit, ISS Medical Accessory Kit (IMAK), Crew Worn-On Items, and ISS Crew Provisions.

- a. The spacecraft shall accommodate a total of 85 kg (187 lbs) of NASA-provided supplies.
- b. The spacecraft shall provide a total of 0.323 cubic meters (11.4 cubic feet) of NASA-provided supplies stowage volume. [R.CTS.336] [I]

*Rationale: NASA has determined that certain items, such as food, clothing, personal dosimeters, a medical kit, and an environmental kit, will be provided to the NASA crew since many of these items will be the same product that they will use on their 180 day stay on the ISS. A notional list of NASA-provided supplies for NASA crew with mass and volumes can be found in Appendix J for reference. Some items in the NASA-provided supplies are driven by the operational timelines and contingency days. The base value for food was chosen in accordance with the notional timeline in Appendix P. For mission durations greater than this, additional food would be required. It is easier for the crew to have the same individual item and familiarity and training with the common items (e.g., Medical Kit) during both the free-flight and docked portions of the mission. For these items, the spacecraft must provide the appropriate stowage and interfaces to properly store the equipment prior to use. These items are not cargo or payload and are in addition to the 100 kg of cargo called out in requirement 3.1.3.1.*

### **3.1.1.7 Supplies for Non-NASA Crew**

The CTS shall provide habitable consumables, such as food, water, clothing, oxygen, nitrogen, CO<sub>2</sub> removal, personal hygiene, and other required consumables, for non-NASA crew during the docked portion of the mission when the non-NASA crewmembers are on the ISS. [R.CTS.006] [I]

*Rationale: For any mission model that requires additional crew beyond the 4 NASA crew required for the ISS increment, the CTS will be responsible for carrying the required logistics in the spacecraft to support the additional crewmembers during docked timeframe. NASA will not have the ability to pre-position supplies on ISS via another cargo launch vehicle due to the required ISS logistics support via Cargo Resupply Contract (CRS), Progress, and Automated Transfer Vehicle (ATV)/H-II Transfer Vehicle (HTV) vehicles. Thus, the CTS will be responsible for providing food, water, clothing, and other logistics for non-NASA crew. The nitrogen only needs to be provided if any equipment or operation to support the non-NASA crew is venting air overboard as part of its nominal operation.*

### **3.1.1.8 NASA Crew**

The CTS shall accommodate 1, 2, 3, and 4 NASA crewmembers during a single mission. [R.CTS.389] [I]

*Rationale: Four NASA crew are required to be transported and returned to the ISS during a single mission to meet the United States Operations Segment (USOS) demand for crew time based on full utilization of the ISS to perform science and support the ISS National Laboratory Program. All docking and undocking operations are a significant impact to the completion of ISS science, resulting in the determination by the ISS Program that the most efficient crew rotations strategy is to launch and return 4 crewmembers on a single vehicle. Additionally, the CTS must be able to perform the mission with crew complements of 1, 2, 3, or 4 crewmembers in a single launch or landing to provide flexibility in the ISS crew rotation plan.*

### **3.1.2 Crew Transportation**

#### **3.1.2.1 Transport Crew**

The CTS shall transport NASA crew to the ISS. [R.CTS.010] [I]

*Rationale: NASA crew are required to be transported to the ISS to meet the United States Operations Segment (USOS) demand for crew time based on full utilization of the ISS to perform science and support the ISS National Laboratory Program.*

#### **3.1.2.2 Return Crew**

The CTS shall return NASA crew from the ISS. [R.CTS.011] [I]

*Rationale: NASA crew are required to be returned from the ISS to meet the United States Operations Segment (USOS) demand for crew time based on full utilization of the ISS to perform science and support the ISS National Laboratory Program.*

#### **3.1.2.3 Docked Duration**

The spacecraft shall be capable of being docked to the ISS for 210 days to provide an assured crew return capability for 4 NASA crew. [R.CTS.012] [I]

*Rationale: The ISS requires continuous presence of the spacecraft to support sustained operations. The 210 days provides 30 days of contingency on the nominal 180 day turnaround.*

#### **3.1.2.4 Rotation Intervals**

The CTS shall be capable of exchanging up to 4 NASA ISS crewmembers every 150 to 210 days. [R.CTS.013] [I]

*Rationale: The nominal crew rotation will occur at approximately 180 days based on the ISS human research program medical data collection needs. It is possible for this rotation to be altered by one month (earlier or later) in order to accommodate other overall ISS Program requirements or anomaly resolution/response.*

#### **3.1.2.5 Launch Sites**

The CTS shall launch from a U.S. (or U. S. State Department approved) launch site(s). [R.CTS.014]

*Rationale: Launching from a designated U.S. (or U.S. State Department approved) launch sites reduces risk by minimizing necessary abort recovery force assets, increasing proximity to U.S. medical facilities, increasing security, and ensuring a prepared launch and emergency landing site, which minimizes unknown hazards and potential security issues.*

### 3.1.2.6 Landing Sites

The CTS shall return the NASA ISS crew to a designated primary landing site for nominal landings. [R.CTS.015]

*Rationale: Returning to a designated continental U.S. landing site or waters directly extending from the coast reduces risk by minimizing necessary recovery force assets, increasing proximity to U.S. medical facilities, increasing security, and ensuring a prepared landing site free of hazards. Deconditioned crewmembers have impaired musculoskeletal, cardiopulmonary, and neurovestibular capabilities as a result of long duration exposure to the micro-gravity and space environment, resulting in degraded crewmember performance in the post-landing timeframe. Because of the deconditioned state of the crew, special considerations need to be provided for medical and other post-landing care.*

### 3.1.3 Cargo Transportation

This cargo includes any NASA items (ISS maintenance hardware, powered payloads, etc.), but does not include any required items for spacecraft maintenance, food, water, clothing, hygiene or other crew provisions, medical or environmental kits, documentation or other equipment required to operate the spacecraft, etc. These items required for crew sustenance and operations of the spacecraft will be provided by the CTS and will be allocated mass and volume in addition to cargo goals defined below.

#### 3.1.3.1 Accommodate Soft Stowage Cargo

The spacecraft shall accommodate 100 kg (220.5 lbm) of soft stowage cargo in the pressurized volume during a single mission.

- a. The spacecraft shall provide a total of 0.227 cubic meters (8 cubic feet) of pressurized volume to accommodate standard soft stowage cargo.
- b. The spacecraft shall provide a contiguous volume with the dimensions 0.468 m x 0.556 m x 0.6245 m (18.4 in x 21.9 in x 24.6 in) within the 0.227 cubic meters (8 cubic feet) volume to accommodate time critical cargo.
- c. The spacecraft shall provide soft stowage cargo accommodations per requirements in SSP 50833, ISS Cargo Transport Requirements Document, Section 3.1.2, except for Triple CTB's in section 3.1.2.1 and all M-Bags in section 3.1.2.2. [R.CTS.016] [I]

*Rationale: The 100 kg, 0.227 cubic meter cargo requirement is sized to transport a small amount of ISS Program-specified cargo inside the spacecraft to be transferred to the ISS upon arrival. The cargo will be contained in either a standard set of ISS soft stowage cargo to easily accommodate transfer by the crew onorbit. The dimensions of 0.468 m x 0.556 m x 0.6245 m (18.4 in x 21.9 in x 24.6 in) and volume of 0.1625 cubic meters (5.74 cubic feet) are equivalent to a double-middeck locker and was chosen such that it would be a candidate location for the hard mounted cargo swap required by requirement 3.1.3.5. The cargo in this volume (whether hard mounted or soft stowage) must be accessible as time-critical cargo. Maximum flexibility in configuring the cargo items is important since failures of hardware components on the ISS will be a factor in the cargo items manifested on a given CTS mission.*

#### 3.1.3.2 RESERVED

### 3.1.3.3 Cargo in lieu of Crew

The spacecraft shall accommodate an additional 100 kg (220.5 lbm) of soft stowage cargo in lieu of a NASA crewmember during a single mission per requirements in SSP 50833, Section 3.1.2, except for Triple CTB's in section 3.1.2.1 and all M-Bags in section 3.1.2.2. [R.CTS.020] [I]

*Rationale: The transport of an additional 100 kg of soft stowage cargo in lieu of a NASA crewmember provides the capability to react to situations that dictate the timely delivery and return of ISS components, supplies, and science hardware due to operational needs of the ISS. Obviously, maximum flexibility in the size, volume, and mass is important to accommodate a wide range of potential cargo. The concept proposed is that the seat would be removed to allow for a cargo pallet or other structure to be flown in its place in order to properly restrain the cargo.*

### 3.1.3.4 Accommodate Hard Mounted Cargo

The spacecraft shall accommodate hard mounted time-critical cargo consisting of either two powered single middeck lockers or one powered double middeck locker in the pressurized volume during a single mission, and maintain cargo services per requirements in SSP 50833, Section 3.1.1 while installed.

- a. The spacecraft shall accommodate time-critical, soft stowage cargo in lieu of the hard mounted cargo per requirements in SSP 50833, section 3.1.2, except for Triple CTB's in section 3.1.2.1 and all M-Bags in section 3.1.2.2. [R.CTS.021] [I]

*Rationale: The intent of this requirement is to allow for the transport of time-critical cargo in a powered middeck locker or lockers. ISS power necessary for the locker(s) will be provided from docking until payload transfer in addition to, not in lieu of, all other power allocations specified herein or within SSP 50808, such as requirement 3.4.2.5, ISS Safe Haven or SSP 50808 3.2.2.4.1.3, Power Consumption. The mass and volume associated with transport of the locker(s) are required in addition to, not in lieu of or included within, all other mass and volume requirements specified herein, i.e., the 100kg (220.5 lb) of pressurized cargo defined in requirements 3.1.3.1 and 3.1.3.5. The middeck locker(s) would be provided by the ISS Program either prior to launch or during onorbit operations to be transported to or from the ISS with a known quantity of science samples inside. When the need arises, operational flexibility is required to allow the ISS Program to fly additional passive cargo within the mass and volume of the powered lockers.*

### 3.1.3.5 Hard Mounted Cargo in lieu of Soft Stowage Cargo

The spacecraft shall accommodate additional time-critical hard mounted cargo consisting of either two powered single middeck lockers or one powered double middeck locker, during a single mission in lieu of the soft stowage cargo required by 3.1.3.1.

- a. The spacecraft shall provide the additional hard mounted cargo per requirements in SSP 50833, Section 3.1.1.
- b. The spacecraft shall provide at least 220W power and 220W heat rejection for the sum of all cargo in lieu of the power wattages defined in SSP 50833, Sections 3.1.1.3.1 and 3.1.1.5.3. [R.CTS.383] [I]

*Rationale: Due to the shortfall in powered cargo transport needed to support ISS research, the ISS program needs the ability to fly additional powered payloads instead of the passive*

*payloads specified in 3.1.3.1. The intent of this requirement is to allow for the transport of scientific samples in a powered middeck locker or lockers. ISS power necessary for the locker(s) will be provided from docking until payload transfer in addition to, not in lieu of, all other power allocations specified herein or within SSP 50808, such as 3.4.2.5 ISS Safe Haven or SSP 50808, 3.2.2.4.1.3 Power Consumption. The middeck locker(s) would be provided by ISS either prior to launch or during onorbit operations to be transported to or from ISS with a known quantity of science samples inside.*

### **3.1.3.6 Time-Critical Cargo Pre-Launch Handling**

The CTS shall maintain cargo services per SSP 50833, Sections 3.1.1 and install time-critical cargo within 24 hours of a scheduled launch. [R.CTS.018] [I]

*Rationale: Once time-critical cargo has been handed over from the ISS program, it is critical that cargo services be maintained to ensure the integrity of the cargo. Late cargo installation, within 24 hours of scheduled launch, is required to maintain the integrity of time-critical cargo. The CTS may select the specific integration window, as long as it is within 24 hours of scheduled launch. This requirement addresses both soft stowage and hard mounted time-critical cargo. The time-critical cargo installation may include an Integrated Verification Test (IVT) to verify the interface between the spacecraft and the payload and must be completed within the L-24 window of opportunity. Once installed, the CTS must maintain cargo services, if required, until the cargo is removed for transfer to the ISS. In the event that a launch is scrubbed or delayed and rescheduled, access to remove and re-install the time-critical cargo would need to be provided as well.*

### **3.1.3.7 Time-Critical Cargo Removal**

The CTS shall remove ISS time-critical cargo from the spacecraft no later than 1 hour after crew egress, post-docking and post-landing at a supported landing site. [R.CTS.019] [I]

*Rationale: Early cargo access after spacecraft docking and landing is required to maintain the integrity of time-critical cargo. On orbit, the ISS crew must perform post-docking procedures quickly such that the cargo transfer can also occur no later than one hour after crew egress from the spacecraft. The CTS will provide the capability to retrieve time-critical cargo within 1 hour upon completion of crew egress after post-landing and post-docking, while also providing continuous cargo services, per SSP 50833.*

### **3.1.3.8 Docked Cargo Services**

The spacecraft shall maintain cargo services per SSP 50833, Sections 3.1.1, for 48 hours post-docking and pre-undocking. [R.CTS.394] [I]

*Rationale: The ISS program requires the operational flexibility to best utilize crew time and manage the crew day. Mission priorities may preclude cargo transfer immediately following docking or prior to undocking requiring the spacecraft to maintain the specified environment and services until cargo transfer can be completed. In these scenarios, the spacecraft will receive the necessary ISS resources, e.g. power and intermodule ventilation (IMV), to support this mode of operation.*

## **3.1.4 Launch and Landing Probability/Availability**

### 3.1.4.1 Launch Availability

The CTS shall have a launch probability not less than 80% for each launch opportunity, exclusive of external launch constraints and abort zone weather, for the time interval beginning with tanking and ending with the launch window close for that attempt. [R.CTS.022] [I]

*Rationale: The launch vehicle, spacecraft, and ground infrastructure must be designed to have a high launch probability once the vehicle is in the final stages of preparation for launch. Each point at which the ISS is within the planar and phasing capabilities of the system is considered a launch opportunity; therefore, probability must be calculated throughout the year for these daily opportunities. The timeframe begins with booster tanking on the launch day, which signals a commitment to launch on that day and ends when a launch is no longer possible due to performance limitations.*

*Systems reliability, launch constraints, and CTS design-imposed weather constraints are driven by the CTS design, and must be included in the launch probability calculation. Examples include launch pad winds affecting tower clearance, the ability to fly through precipitation, and upper level winds. External constraints are conditions outside the Commercial Provider's control (reference Appendix B), and are not included in the launch probability calculation.*

### 3.1.4.2 Launch Recycle Time

The CTS shall be ready to launch at the opening of the launch window on the calendar day following a missed initial launch attempt due to external launch constraints. [R.CTS.023] [I]

*Rationale: The launch vehicle, spacecraft, and ground infrastructure should be designed and sized to nominally launch on consecutive days in order to support nominal scheduling operations for the range. Additionally, resupply traffic considerations, crew rotation plans, and ISS operations require high schedule confidence for the arrival of the spacecraft at the ISS. External constraints are conditions outside the provider's control (reference Appendix B). The system should be able to recycle if the launch scrub was not due to the vehicle. The focus should be on recycle, not on repair.*

### 3.1.4.3 Launch Lighting

The CTS shall launch the integrated space vehicle in all ambient lighting conditions. [R.CTS.024]

*Rationale: The launch time for a rendezvous with the ISS varies by 24 minutes each day, resulting in a dramatic change in the launch time over a two-week period. Use of night-time launch windows greatly increases the opportunities for launch to a successful rendezvous orbit. Approximately 40% of the launch opportunities to the ISS occur in darkness when assessed over a one-year period. Therefore, ambient lighting restrictions would severely impact the ability to launch on most days throughout the year, which is required to meet the overall ISS Program requirements. Even during daylight hours, some environmental conditions (i.e. fog, light rain, high humidity) can preclude visibility and should be taken into account.*

### 3.1.4.4 Landing Lighting

The CTS shall perform landing in all ambient lighting conditions. [R.CTS.025]

*Rationale: The capability to land in day or night lighting conditions will maximize landing opportunities, which is required due to the future ISS traffic models with resupply occurring from a multitude of vehicles. Additionally, for launch abort landings or for early mission termination, the lighting may be either daylight or dark. In order to maximize crew survivability, the CTS should be able to land in all lighting conditions.*

### **3.1.5 Onorbit**

#### **3.1.5.1 RPOD Lighting**

The CTS shall perform rendezvous, proximity operations, docking (RPOD) and undocking independent of ambient lighting conditions and ground overflight constraints, to enable docking and undocking during 95% of the planned orbit. [R.CTS.026] [I]

*Rationale: The intent of this requirement is that ambient lighting or ground overflight constraints should not affect final rendezvous, proximity operations, docking or undocking operations, or normal ISS operations, in terms of crew timeline considerations or docking attitudes.*

*This does not necessarily require that each navigation sensor be capable of operating in all lighting conditions. The CTS should not require proximity operations and docking to be aborted due to ambient lighting conditions. The trajectory and timeline should be forgiving enough to accommodate minor approach adjustments during brief periods of degraded navigation/crew visibility due to orbital lighting conditions, and allow docking and undocking operations to occur over a large portion of the planned orbit.*

*Docking over a particular set of ground stations could limit docking to a very small allowable time period. This could overly constrain launch time or could require a significant wait time on orbit, particularly if a docking opportunity is missed. Docking independent of ground overflight constraints avoids these restrictions and added resource requirements.*

#### **3.1.5.2 Relocate to Different Docking Port**

The spacecraft shall perform one relocation from the initial docking port to another available USOS docking port after the initial spacecraft docking to the ISS. [R.CTS.027] [I]

*Rationale: The ISS configuration is expected to be dynamic in the foreseeable future, as the ISS will be required to manage heavy visiting vehicle traffic and accommodate exploration modules, new utilization experiments, etc. Providing port relocation capability allows the ISS to make late port utilization decisions, and in general, provides ISS visiting vehicle traffic operational flexibility thru end of life. Port relocations will be performed only on selected missions. Relocations are performed with full crew complement without using the station robotic arm. It is not necessary to protect consumables for port-to-port relocations.*

#### **3.1.5.3 ISS Fly-around**

The spacecraft shall perform one complete fly-around at a range of less than 250 meters, as measured from spacecraft center of mass to ISS center of mass, after undocking from the ISS. [R.CTS.028] [I]

*Rationale: The ISS Program requires periodic inspections of portions of the ISS that are not visible from the ISS windows or from the external ISS cameras. In order for the spacecraft to execute the fly-around, the guidance, navigation, and control (GN&C), rendezvous sensors, propulsion, crew displays and controls, and other systems must be designed to provide for*



*this capability. However, consumables will not be reserved. The fly-around will only be executed on missions where sufficient consumables are available. The actual range of the fly-around will be determined jointly with NASA, based on the GN&C and propulsion on the spacecraft. Minimum safe distance for a fly-around will be determined in part by the trajectory and plume related requirements in the SSP 50808. The fly-around should occur as close to the ISS as possible, while meeting these requirements, at a range of less than 250 meters and result in a 360 degree planar transit around the ISS. 250 meters was chosen as the upper limit based on considerations of increased propellant usage and decreasing flight crew camera imaging capabilities and is consistent with Space Shuttle fly-around experience.*

#### **3.1.5.4 Support Photography during Fly-Around**

The spacecraft shall provide for crew photography of the ISS during a fly-around through an optically uniform window that meets or exceeds Category D optical properties per JSC 66320, Optical Property Requirements for Glasses, Ceramics, and Plastics in Spacecraft Window Systems. [R.CTS.384] [I]

*Rationale: The ISS Program requires images in support of the periodic inspections of portions of the ISS that are not visible from the ISS windows or from the external ISS cameras. In order to take these images with a NASA-provided hand-held camera, which is transported as flight crew equipment, the spacecraft needs a window that is accessible to a crewmember in the flight configuration that does not impede piloting tasks. In addition, the window must have sufficient optical quality that the photography can produce the necessary images required for anomaly resolution.*

## 3.2 Safety and Mission Assurance

### 3.2.1 Crew Safety

#### 3.2.1.1 Loss of Crew Risk

The CTS shall safely execute the objectives defined in Section 3.1 with the following Loss of Crew (LOC) requirements for the various mission phases.

- a. The overall LOC probability distribution for an ISS mission shall have a mean value no greater than 1 in 200 without utilizing operational controls implemented by the ISS, such as TPS inspections.
- b. The LOC probability distribution for the combined ascent and entry phases of an ISS mission shall have a mean value no greater than 1 in 500. [R.CTS.030]

*Rationale: The LOC requirement is consistent with NASA's defined goals and thresholds for crewed vehicles. The LOC values are part of the overall certification process for the commercial launch vehicle and spacecraft and establish a basis for decision making relative to safety enhancing features in the design, including failure tolerance. The LOC requirement represents a design robustness criteria to be managed by the commercial provider alone.*

#### 3.2.1.2 Loss of Mission Risk

The CTS Loss of Mission (LOM) probability distribution for an ISS mission shall have a mean value of no greater than 1 in 55. [R.CTS.031]

*Rationale: The LOM requirement is consistent with NASA's defined goals and thresholds for crewed vehicles. LOM values are part of the overall certification process for the commercial launch vehicle and spacecraft and establish a basis for decision making relative to mission enhancing features in the design, including failure tolerance.*

#### 3.2.1.3 Flight Element Stability

The CTS flight elements shall be both stable and controllable for nominal and abort flight mission phases. [R.CTS.317]

*Rationale: Maintaining stability and control of the vehicle during all flight phases (ascent, abort, onorbit, entry, descent, and landing) is a fundamental safety requirement of human space flight. All control systems used for crewed flight must show stability and sufficient control authority during normal flight, dispersed conditions, and certain failure conditions. Passively controlled phases of flight, such as when on parachutes, must show stability. This also provides safety margin for flight to cover for inaccuracies in vehicle and environmental modeling.*

### 3.2.2 Safety and Hazard Control

#### 3.2.2.1 Monitor Controls and Inhibits

The CTS shall monitor the status of controls and inhibits associated with functions whose inadvertent activation and those functions whose failure to activate when required could have catastrophic results. [R.CTS.033]

*Rationale: Controls are hardware and software features provided to mitigate (reduce the likelihood of) the cause of a catastrophic hazard. Inhibits are a special implementation of hazard controls for safety-critical functions, which disable the functions. Monitoring*

*controls and inhibits ensures they are functional and effective at all times. In addition, monitoring provides situational awareness of the state of the vehicle and the risks presented by a change in the status of these controls. This knowledge can support actions to move to a less hazardous state or inform decisions while operation in this state.*

### **3.2.2.2 Control Critical Hazards**

The CTS shall control critical hazards. [R.CTS.341]

*Rationale: A critical hazard is a condition that may cause a severe injury or occupational illness. Control of critical hazards ensures the health of the crew.*

### **3.2.3 Failure Tolerance**

#### **3.2.3.1 Failure Tolerance to Catastrophic Events**

The CTS shall provide failure tolerance for the control of catastrophic hazards, with the specific level of failure tolerance (one or more) and implementation (the use of similar or dissimilar redundancy) derived from an analysis of hazards, failure modes, and risk associated with the system.

- a. The CTS shall provide dual failure tolerance or single failure tolerance with dissimilar redundancy for the control of catastrophic hazards in the systems that provide the guidance, navigation, and flight path/trajectory control functions for the deorbit burn, entry, and landing phases of the mission.
- b. Failure of primary structure, structural failure of pressure vessel walls, and failure of pressurized lines are excepted from the failure tolerance requirement, provided the potentially catastrophic failures are controlled through a defined process approved by NASA and in which standards and margins are implemented that account for the absence of failure tolerance.
- c. Failure of aerodynamic control effectors and parachutes are excepted from the dual failure tolerance requirement in sub-paragraph a., and are governed by the base requirement for one or more levels of failure tolerance as derived from an analysis of hazards, failure modes, and risk associated with the system. [R.CTS.034]

*Rationale: The overall objective is to provide the safest design that can accomplish the mission, given the constraints imposed on the Program. Since a CTS development will always have mass, volume, schedule, and cost constraints, choosing where and how to apply failure tolerance requires integrated analyses at the system level to assess safety and mission risks. First and foremost, the failure tolerance is applied at the overall system level to include all capabilities of the system (software, hardware, operations). While failure tolerance is a term frequently used to describe minimum acceptable redundancy, it may also be used to describe two similar systems, dissimilar systems, cross-strapping, or functional interrelationships that ensure minimally acceptable system performance despite failures, or additional features that completely mitigate the effects of failures. Even when assessing failure tolerance at the integrated system level, the increased complexity and the additional utilization of system resources (e.g., mass, power) required by a failure tolerant design may negatively impact overall system safety as the level of failure tolerance is increased.*

*Ultimately, the level and type of redundancy (similar or dissimilar) is an important and often controversial aspect of system design. Since redundancy does not, by itself, make a system*

*safe, it is the responsibility of the engineering and safety teams to determine the safest practical system design given the mission requirements and constraints. Additionally, the overall system reliability is a significant element of the integrated safety and design analysis used in the determination of the level of redundancy. Redundancy alone without sufficient reliability does not meet the intent of this requirement. Catastrophic events, as defined in this document and consistent with NPR 8715.3, NASA General Safety Program Requirements, include crew fatality and the unplanned loss/destruction of a major element of the crewed space system during the mission that could potentially lead to death or permanent disability of the crew or passengers.*

*Where failure tolerance is not the appropriate approach to control hazards, specific measures need to be employed to: 1) recognize the importance of the hazards being controlled, 2) ensure robustness of the design, and 3) ensure adequate attention/focus is being applied to the design, manufacture, implementation, test, analysis, and inspection of the items and/or software. Where the CTS cannot provide the minimum required failure tolerance to control a catastrophic hazard, NASA may grant an exception to the requirements provided: a) the analysis can quantify, with sufficient confidence, the risk delta associated with the reduction in failure tolerance, b) NASA determines the risk is acceptable, or c) the hazard is controlled through a defined process in which standards and margins are implemented that account for the reduced failure tolerance.*

### **3.2.3.2 Failure Tolerance without Aborts**

The CTS shall provide the failure tolerance to catastrophic events, required in requirement 3.2.3.1, without the use of pad or ascent aborts or other emergency equipment and systems (emergency equipment and systems are defined in Section 3.2.5 of this document).

- a. Appropriate credit may be taken for pad or ascent aborts and other emergency equipment and systems for the LOC assessments (defined in Section 3.2.1 of this document.). [R.CTS.035]

*Rationale: Emergency systems and equipment, such as fire suppression systems, fire extinguishers, emergency breathing masks, launch/entry pressure suits, ballistic unguided entry capability, and ascent aborts, are not to be considered part of the failure tolerance capability. Emergency systems are there to mitigate the effects of a hazard, when the first line of defense, in the form of failure tolerance, cannot prevent the occurrence of the hazardous situation. Emergency systems may be used for LOC assessments even though some of these capabilities, such as aborts or ballistic entry, may return the crew to Earth someplace other than the nominal or backup landing locations and place the crew in a survival situation.*

### **3.2.3.3 Separation of Redundant Systems**

The CTS should separate or protect redundant systems, redundant subsystems, and redundant major elements of subsystems (such as assemblies, panels, power supplies, tanks, controls, and associated interconnecting wiring and fluid lines) to ensure that an unexpected event which damages one is not likely to prevent the other from performing the functions. [R.CTS.339]

*Rationale: Where redundancy is used to satisfy the failure tolerance requirement, this design guideline should be considered to provide maximum protection from common cause events.*

### 3.2.3.4 Isolate and Recover from Faults

The CTS shall isolate faults and recover lost functions that would result in a catastrophic event. [R.CTS.038]

*Rationale: A hazard analysis identifies the causes of hazards and the controls needed for these causes to assure safety. It is necessary to ensure the controls can be activated to isolate the fault and prevent further propagation of the hazard. Once the fault is isolated, critical functions must continue, which is protected for by the failure tolerance requirement. The isolation of faults cannot interfere with the implementation of failure tolerance.*

### 3.2.3.5 Failure Tolerance without Corrective Maintenance

The CTS shall provide failure tolerance to catastrophic events, required in requirement 3.2.3.1, without the use of corrective maintenance. [R.CTS.125]

*Rationale: Where redundancy is required to satisfy failure tolerance requirements, the redundancy must be built into the spacecraft system and not rely on crew maintenance to replace a failed component or avionics unit. An additional component that is onboard the spacecraft but not designed to be a functional operating part of the system will not be allowed to be considered in order to meet the failure tolerance requirements. For example, two non-functional spare avionics boxes stowed onboard, but not connected to a system, cannot be used to declare a single failure tolerant subsystem to be three-failure tolerant.*

## 3.2.4 Health and Status

### 3.2.4.1 Detect and Annunciate Faults

The CTS shall detect and annunciate critical faults. [R.CTS.037]

*Rationale: A fault is defined as an undesired system state. A failure is an actual malfunction of a hardware or software item's intended function. The definition of the term "fault" envelopes the word "failure" since faults include other undesired events, such as software anomalies and operational anomalies. A critical fault would result in a catastrophic event or an abort. It is necessary to alert the crew to faults (not just failures) that affect critical functions. An alerting system decreases the cognitive load on the crew. Terminology, references, and graphics used are to be coordinated with other crew task demands so as to minimize additional training.*

### 3.2.4.2 Record and Display Health and Status

The CTS shall generate health, status, and engineering data to be used as follows:

- a. Display health and status data onboard to the crew for nominal operations and flight anomaly resolution.
- b. Transmit health, status, and engineering data required for nominal operations, flight anomaly resolution, catastrophic event reconstruction and commit to flight decision making to the CVCC.
- c. When the vehicle is out of communication, record health, status, and engineering data onboard for later transmission. [R.CTS.040]

*Rationale: Access to spacecraft and launch vehicle health, status, and engineering data is a key element of command decision making and anomaly resolution during the mission. Making the data available to both the CVCC and crew could prevent the crew from executing*

*an abort or prevent a situation from developing into a catastrophic event. Post-flight, the data will be used to understand system performance and make further improvements to operation and safety, as well as inform future commit to flight decision making. The design optimization will establish how much data should be displayed, recorded, and transmitted and during which periods to support nominal operations, flight anomaly resolution, and catastrophic event reconstruction. Data transmitted during ISS docked operations is subject to requirements in SSP 50808.*

### **3.2.4.3 Flight Imagery**

The CTS shall provide motion and still imagery during critical mission phases to support performance assessment, anomaly resolution, and mishap investigation. [R.CTS.072]

*Rationale: During critical mission phases (i.e., major vehicle configuration or state changes), imagery provides a complementary means of assessing flight performance where instrumentation alone is insufficient to validate vehicle performance and hazard controls. Post-flight, the data will be used to understand system performance and make further improvements to operation and safety. The design optimization will establish how much vehicle imagery should be recorded and transmitted and during which periods to support operations, performance assessment, flight anomaly resolution, and mishap event reconstruction. Ground-based imagery of ascent may be limited to imagery obtained at the launch site. Downrange imagery can be obtained by utilizing airborne and/or maritime assets. Proximity operations imagery may be restricted to existing ISS camera assets. Imagery of descent and ground-based imagery of landing may be limited to nominal, pre-designated landing sites. This data, particularly time-synchronized imagery, has been an invaluable complement to other instrumentation when off-nominal events have occurred during flight. This requirement is not meant to imply 100% continuous imagery capture.*

### **3.2.4.4 Monitor Environments**

The CTS shall capture direct and indirect effects of natural and induced environments that could result in exceedances of the integrated space vehicle design limits prior to launch. [R.CTS.074]

*Rationale: The conditions that the launch vehicle and spacecraft are exposed to prior to launch must be assessed against the design environments used for certification and to support commit-to-flight decision making. These environments include atmospheric conditions (including lightning), handling/transport loads, interface loads, and other conditions that the vehicle is exposed to, which could invalidate design assumptions. Objective evidence will be needed to demonstrate that the flight hardware has been maintained within certification limits prior to launch. This data has been invaluable when off-nominal events have occurred prior to launch (e.g., extreme weather events, transportation mishaps, lifting mishaps). This requirement is not meant to imply 100% continuous data capture for all hardware prior to launch. The design optimization will establish how much data should be captured and during which periods where the hardware is at risk of being exposed to natural and induced environments that may exceed certification limits.*

### **3.2.4.5 Natural Environments**

The CTS shall establish and utilize a standard set of natural environment data and models. [R.CTS.382]

*Rationale: Environments refers to all environmental factors appropriate to the CTS DRMs that influence the design or the function of flight systems. They consist of a variety of external environments (most of natural origin and a few of human origin), which impose restrictions or otherwise impact the development or operation of aerospace vehicles. Natural environments are outside the actual control of NASA and the Commercial Provider, so the Commercial Provider should control the risks and "definition" of these factors (i.e., the models, data sets, and descriptions) in order to maintain a uniform, consistent, and verifiable baseline for hardware development.*

### **3.2.5 Emergency Equipment**

#### **3.2.5.1 Access Emergency Equipment**

The CTS shall provide crew access to equipment involved in the response to emergency situations in all flight phases without the use of tools and within the time required to respond to the hazard. [R.CTS.041]

*Rationale: Fire extinguishers are one example of the type of equipment needed for immediate response to a fire emergency. Crew access means that the crew inside the spacecraft is able to access the equipment in the time required, depending on the phase of flight and the time to effect of the hazard. Crew access also accounts for encumbered crewmembers if the equipment could be needed during a mission phase or operation where the crew is suited. A contamination clean-up kit is an example of equipment needed for follow up/recovery operations.*

*Design requirements are to consider all emergency scenarios requiring access to equipment for emergency response and needed for follow-up/recovery actions. The location and proximity of emergency equipment to the crew will impact accessibility. Furthermore, each emergency may have a unique time requirement and, therefore, a different constraint on access.*

*Due to the critical nature of the situation, time-critical and emergency equipment must permit crew access and operation without the use of tools to unstow or operate the equipment.*

#### **3.2.5.2 Breathing Mask**

The spacecraft shall supply a breathing apparatus (mask) for all crewmembers whenever the cabin atmosphere may be contaminated and whenever an unplanned reduction in cabin pressure occurs. The apparatus shall:

- a. Protect the eyes and respiratory tract from a contaminated cabin atmosphere.
- b. Maintain breathing zone ppO<sub>2</sub> and ppCO<sub>2</sub> levels, defined in Table 3.10.11.1.1-1, for response to a contamination contingency until CO, HCN, and HCl has been re-established per table 3.10.11.1.3-1.
- c. Supply nominal 100% oxygen for a depressurization contingency until crewmembers are in fully functioning pressure suit. [R.CTS.042]

*Rationale: The intent of this requirement is to supply crew with breathing apparatuses that provide protection and breathing gases within established limits and to define duration for apparatus function. The two scenarios for which a breathing mask would be employed include a contaminated atmosphere due to fire or toxic release and an unplanned reduction*

*in cabin pressure. This requirement can be met with many different implementations involving one or more masks.*

*For the contaminated atmosphere case, each crewmember will require delivery of uncontaminated and appropriate breathing gas in order to avoid crew performance impacts and allow for crew survival until concentrations of CO, HCN, and HCl have been re-established per Table 3.10.11.1.3-1. The timeframe for which masks are required is governed by the system that removes particulates from the cabin, including cabin purges and/or a filtering system. For the depress contingency, breathing apparatus must maintain 100% oxygen delivery until each crewmember is in a fully functional pressure suit or is in a habitable environment. The timeframe for fully functional suit includes donning, buttoning up, flowing O2, and passing leak check.*

*In the case that an unplanned reduction in cabin pressure occurs, the crew should be able to breathe 100% oxygen to reduce their risk of decompression sickness (DCS) and prevent hypoxia as the scenario unfolds. The operational decision on when to use 100% oxygen to mitigate DCS risk and prevent hypoxia may need to be weighed against fire risk if oxygen use results in increased cabin ppO2.*

### 3.2.5.3 Voice Communication in Breathing Apparatus

The CTS shall provide voice communication between each of the crewmembers and the CVCC when wearing the contingency breathing apparatus in the spacecraft. [R.CTS.043]

### 3.2.5.4 Emergency Lighting

The CTS shall provide automatically activated emergency lighting for crew egress and operational recovery in accordance with Table 3.2.5.4-1. [R.CTS.044]

*Rationale: Emergency lighting is a part of the overall lighting system for all vehicles. It allows for crew egress and operational recovery in the event of a general power failure. Efficient transit includes appropriate orientation with respect to doorways and hatches, as well as obstacle avoidance along the egress path. The emergency lighting system may include unpowered illumination sources that provide markers or orientation cues for crew egress. Design guidance for emergency lighting can be found in NASA/SP-2010-3407, Human Integration Design Handbook (HIDH).*

**Table 3.2.5.4-1: Emergency Lighting Intensity Levels**

Area <sup>(1)</sup> or Task <sup>(1)</sup>	Lux <sup>(2)</sup>	Ft. C <sup>(2)</sup>
Passageway	10	1
Emergency Task	32	3
Notes: (1) Levels are measured at the task object or 789 mm (30 in.) above floor, as applicable. (2) All levels are minimum.		



### 3.2.5.5 Portable Fire Suppression

The spacecraft shall contain a manually operated, portable fire suppression system accessible by the crew within 1 minute. [R.CTS.045]

*Rationale: The crew must have portable fire-fighting capability, even if a fixed fire-fighting system is provided in enclosed/isolated areas in the pressurized crew cabin, in order to quickly extinguish fires in the crew cabin or in areas where the fixed system is ineffective. In pre-launch, post-landing, or docked scenarios the crew must be able to extinguish any fire that impedes egress. For enclosed/isolated areas with potential ignition sources, access ports allow fire suppression without removing access panels. Access panels provide some separation between the habitable crew cabin and fire, combustion products and suppressant in the enclosed area. See also 3.10.12.2 Use of Hazardous Chemicals.*

### 3.2.5.6 Personal Protective Equipment

The spacecraft shall contain Personal Protective Equipment (PPE) for each crewmember in the event of an emergency. [R.CTS.046]

*Rationale: Space flight experience has shown that not all hazards, such as airborne toxic risks, can be completely controlled; therefore, the crew must have access to individual protective equipment in the event of failure of other controls. This equipment may include, but is not limited to, masks, goggles, gloves, eyewash, and contingency breathing apparatus as described in SSP 50653-1, Basic Provisions on Crew Actions in the Event of a Toxic Release on the ISS, Section 13.0, "Personal Protective Equipment." In an emergency, this equipment must be near-to-hand and quickly accessible. PPE is not to interfere with the crew's ability to conduct emergency operations, including communication between crewmembers and with ground personnel. Automation of protective equipment is to be provided for tasks the crew may not be able to perform under emergency or stressful conditions (for example, where the crewmember is distracted or disabled).*

### 3.2.5.7 Fire Detection and Suppression in Isolated Areas

The spacecraft shall provide fire event detection and fire suppression systems for the spacecraft's enclosed/isolated areas in the pressurized volume where there is forced air flow and potential ignition sources or credible oxygen enrichment/leakage and potential ignition sources. [R.CTS.047]

*Rationale: This requirement is to provide fire event detection and fire suppression systems that are integrated into the spacecraft for enclosed/isolated areas in the pressurized crew volume to mitigate the hazardous effects of fires onboard the spacecraft. The type of fire event detection and fire suppression required will be a function of materials selection in conjunction with proximity to ignition sources and oxidizers. Enclosed/isolated areas that the crew cannot reach with a portable fire extinguisher should have a fixed fire suppression system. By definition, there is no risk of fire in enclosed area that does not contain a potential ignition source, such as stowage lockers for food, clothing, or other types of equipment lacking batteries or electrical connectivity to power sources. Such enclosed volumes lacking ignition sources do not require any provisions for fire event detection and suppression. A credible oxygen leak would be any single failure that could cause leakage of oxygen into an enclosed/isolated area. Leakage from pressurized lines, a welded connection, or a mechanical fitting with a metal seal that will not be broken in-flight that has been proof and leak tested are normally acceptable. See also 3.10.12.2 Use of Hazardous Chemicals.*

### 3.2.5.8 Locate Spacecraft after Landing

The spacecraft shall provide its location to the recovery/rescue forces from landing until the recovery/rescue forces arrive. [R.CTS.089]

*Rationale: In the event of a contingency, the spacecraft may not land in the nominal pre-planned location. Experience has shown that the system must provide recovery/rescue teams with continuous information as to the spacecraft's location in a hatch-closed configuration until it is found and recovery/rescue teams can arrive to minimize placing the flight crew in a survival situation.*

### 3.2.5.9 Fire Detection in Habitable Cabin

The spacecraft shall provide fire event detection in the crew habitable cabin. [R.CTS.349]

*Rationale: Since the spacecraft open cabin must provide air circulation for crew respiration, and since various types of in-cabin electrical equipment could provide an ignition source, the open or habitable cabin volume must have provision for fire event detection. Smoke detection will meet the intent of this requirement; however, other detectors such as Carbon Monoxide detectors, flame detectors, or other technologies could be demonstrated in a successful design.*

### 3.2.5.10 Protection from Cabin Depressurization

The CTS shall provide pressure suits as an emergency system to protect each individual crewmember from a depressurized cabin during ascent and entry.

- a. The pressure suit shall operate at a minimum pressure of 3.5 psia.
- b. The pressure suit shall provide nominal 100% O<sub>2</sub> to prevent hypoxia and mitigate the risk of decompression sickness.
- c. The pressure suit shall limit ppCO<sub>2</sub> to less than 5 mm Hg to mitigate the effects of hypercapnia. [R.CTS.048]

*Rationale: Pressure suits for each crewmember are required to protect the crew when a large cabin leak causes depressurization to 0 psia. Both U.S. and Russian human space flight experience has demonstrated that the ascent/entry timeframe is highest risk period for catastrophic failures. The conversion of energy during these timeframes using the processes, materials, and structural factors of safety place the crew at a much greater risk during these flight phases. For these reasons and given the hazard time to effect, the crewmembers will wear pressure suits during ascent and entry. Pressure suits will protect the crew from the low pressure cabin environment and allow the crew to take advantage of the spacecraft operability that exists below certified limits to return the crew to Earth. For short term operations in a spacesuit, the crew needs to be protected against hypoxia and decompression sickness. This requirement does not preclude the crew docking with the ISS in an emergency.*

### 3.2.5.11 Pressure Suits

The following are requirements that define capabilities and/or functions needed in a pressure suit. A pressure suit is a system which provides a safe, habitable environment to each crewmember in the event of a rapid cabin depressurization during ascent or entry, a cabin leak with a subsequent failure of the cabin pressure maintenance system, or a cabin leak and as part of an alternative crew survival strategy. The pressure suit provides an environment for sufficient duration to assess the leak and return the crew safely to Earth.

### 3.2.5.11.1 Suited Habitable Duration

The CTS shall provide sufficient consumables to sustain life of the pressure suited crew in a depressurized cabin for the following conditions:

- a. For the time it takes to perform deorbit, entry, and landing of the vehicle.
- b. An ascent abort at any point along the trajectory. [R.CTS.322]

*Rationale: In the event that the vehicle loses its ability to maintain pressure, the crew needs to be protected until they are safely returned to the surface of the Earth. Sufficient consumables are needed for the crew to safely land following an abort or deorbit, entry, and landing after a loss of cabin pressure.*

### 3.2.5.11.2 Donning during Leak

The suit shall provide for unassisted suit donning and connection to life support. [R.CTS.324]

*Rationale: The intent of this requirement is to ensure that the suit design readily enables donning and connection to life support without assistance by a trained crewmember in order to streamline operational timelines. In addition, unassisted don capability is required in cases whereby other flight crewmembers are unavailable to assist, either because they are incapacitated or physically cannot provide assistance. The risk of a crewmember having to perform an unassisted suit donning in a contingency is significantly mitigated since the crew are required to wear their suits during ascent and entry. This risk is also mitigated by the requirement for the spacecraft cabin to maintain a pressure of no less than 55.2 kPa (8.0 psia) for the time required to execute a deorbit and landing in the event of a cabin leak.*

### 3.2.5.11.3 Suit Communications

The suit shall provide two-way voice communications between each of the crewmembers and the CVCC. [R.CTS.328]

*Rationale: When the crew is suited, they will not be able to hear each other. Additionally, the vehicle audio speakers will not be heard/intelligible, particularly in a vacuum. In these cases, the suit must allow for communication between crewmembers and between the crew and the CVCC.*

### 3.2.5.11.4 Body Waste Management in Suit

The suit shall provide for the capability to contain urine and feces throughout suited operations. [R.CTS.332]

*Rationale: The suit must allow for a diaper or other simple system to contain bodily waste.*

### 3.2.5.11.5 Suit Accommodation of Metabolic Loads

The suit shall accommodate crew metabolic loads provided in Appendix F - Metabolic Loads during all flight phases while maintaining a core body temperature between 97 °F and 100.5 °F. [R.CTS.388]

*Rationale: Metabolic loads, in conjunction with the operational concept, provide an upper bound for oxygen (O<sub>2</sub>) demand, carbon dioxide (CO<sub>2</sub>) production and heat rejection requirements. This information is vital for space suits design. The performance focuses on cooling effectiveness, because core body temperature regulation is critically important to prevent heat-related illnesses. Appendix F provides a short description of the data provided along with the assumptions used in the analysis. Guidance on the use of metabolic load data*

*in the design process can be found in Section 4.11 of JSC 65995. Heat load (increased core temperature and the consequent skin vasodilation) can exacerbate orthostatic intolerance. Therefore, the requirement for a mechanism to control body temperature during re-entry, landing, and post-landing within acceptable limits is tightly coupled with the requirements to provide protection against orthostatic intolerance (compression garments). Protection against orthostatic intolerance includes three major elements: lower body compression garments, fluid loading, and suit dissipation of metabolic heat loads.*

### **3.2.5.12 Unassisted Vehicle Egress**

The CTS shall provide for unassisted egress of the entire crew from the spacecraft within 90 seconds from the decision to egress in both the pre-launch and post-landing flight configurations. [R.CTS.087] [I]

*Rationale: The entire crew must be able to egress the spacecraft to the launch platform or post-landing surface in the event contingencies occur during the pre-launch or the post-landing timeframe. This requirement assumes the crew is able to function in a 1-g environment. Unassisted means without help from ground or rescue personnel or equipment and in the planned configuration for launch and entry in terms of clothing or any special protective equipment, such as a pressure suit. Due to the deconditioned state of the crew after being on orbit for a period of 180 days, the crew will be unable to quickly doff any clothing or protective equipment prior to egress. In fact, in a deconditioned state, the crew may actually require assistance to egress the spacecraft; therefore, a wide range of accommodations such as mobility aids must be planned for landing.*

## **3.2.6 Software**

### **3.2.6.1 Manually Override Software**

The integrated space vehicle shall enable the crew to manually override higher level software control/automation (such as automated abort initiation, configuration change, and mode change) during pre-launch operations and ascent when the override of the software system will not directly cause a catastrophic event. [R.CTS.050]

*Rationale: This is a specific capability necessary for the crew to control the integrated space vehicle and ensure crew survival. The critical nature of software control and automation at the highest system level dictates this as a requirement flowed down from the NPR 8705.2B, NASA Human-Rating Requirements for Space Systems, Section 3.3.2; therefore, the crew must have the capability to control automated configuration changes and mode changes, including inhibiting automated aborts at the system level, as long as an override of the software system is feasible and will not directly cause a catastrophic event.*

### **3.2.6.2 Manually Override Software - Post-Separation**

The spacecraft shall enable the crew to manually override higher level software control/automation (such as automated abort initiation, configuration change, and mode change) during all mission phases post launch vehicle separation, including ISS integrated operations and while docked to the ISS, when the override of the software system will not directly cause a catastrophic event. [R.CTS.370]

*Rationale: This is a specific capability necessary for the crew to control the spacecraft and ensure crew survival. The critical nature of software control and automation at the highest system level dictates this as a requirement flowed down from the NPR 8705.2B, Section*

*3.3.2; therefore, the crew must have the capability to control automated configuration changes and mode changes, including inhibiting automated aborts at the system level, as long as an override of the software system is feasible and will not directly cause a catastrophic event.*

### **3.2.6.3 Autonomous Operation of System**

The integrated space vehicle shall autonomously operate critical system and subsystem functions. [R.CTS.051]

*Rationale: This capability means that the spacecraft does not depend on communication with ground personnel to perform functions that are required to keep the crew alive and return the crew safely. The intent of this requirement is for crewed integrated space vehicles only, and not to drive an uncrewed capability.*

### **3.3 Pre-Launch/Ascent**

#### **3.3.1 Pad and Ascent Aborts**

##### **3.3.1.1 Detect and Initiate Abort**

The integrated space vehicle shall detect and automatically initiate a pad and ascent abort when immediate abort is the only method of crew survival prior to nominal spacecraft separation from launch vehicle. [R.CTS.057]

*Rationale: The primary emphasis of this capability is focused on launch vehicle failures where an immediate safe separation and return of the spacecraft will provide a chance for crew survival. However, spacecraft system failure modes must also be assessed to determine if the immediate response of an automated abort is necessary to save the crew as opposed to a manually initiated abort. Not all potentially catastrophic failures can be detected prior to manifestation. Similarly, system design and analysis cannot guarantee the crew will survive all catastrophic failures of the launch system, but the abort system should provide the best possible chance for the crew to survive. When an imminent catastrophic failure of the launch vehicle is detected, the time to effect requires the abort system to be initiated automatically. Also, if the catastrophic failure itself is detected by a monitoring system, the abort is initiated automatically. This is not intended to require independent implementation by the spacecraft of capabilities inherent to the launch vehicle.*

##### **3.3.1.2 Determine Abort Mode**

The spacecraft shall automatically and autonomously determine the mode for an abort. [R.CTS.056]

*Rationale: For many abort scenarios, the timeframe between the initiating event (engine, thrust vector control, or other significant failure) and the resulting catastrophic event is so short that a human cannot react quickly enough to prevent the loss of the crew. The dynamics of the separation event may result in temporary loss of communications with the CVCC; therefore, an automated system is needed onboard the spacecraft to determine the appropriate abort mode.*

##### **3.3.1.3 Pad Abort**

The CTS shall provide pad abort capability to protect the crew from a hazardous condition on the launch pad with a 95% probability of success with at least 90% confidence. [R.CTS.055]

*Rationale: During the final phase of the launch countdown when the crew has been secured in the vehicle, hazardous situations can arise which require the spacecraft to be quickly separated from the launch vehicle to protect the crew from imminent danger. For example, a launch vehicle propellant leak, impending explosion, or other hazardous situation may require the crew to utilize the pad abort capability to separate the spacecraft from the launch vehicle in a manner that allows a landing at a distance from the pad that protects the crew from the hazard. In order to protect the crew, the system must consider a wide range of hazardous situations, including an explosion of the launch vehicle.*

##### **3.3.1.4 Ascent Abort**

The CTS shall provide continuous autonomous launch abort capability from lift-off through orbital insertion with a 95% probability of success with at least 90% confidence in the event of a loss of thrust or loss of attitude control. [R.CTS.058]

*Rationale: Flying a spacecraft through the atmosphere to orbit entails inherent risk. Analysis, studies, and past experience all provide data supporting ascent abort as the best option for the crew to survive a failure of the launch vehicle. This does not cover assessment of catastrophic conditions assessed by the LOC analysis in requirement 3.2.1.1. These abort performance parameters will include, at a minimum, aborting spacecraft controllability, accelerating away (separating) from the launch vehicle without relying upon the aerodynamic deceleration of the launch vehicle, near-field re-contact with the launch vehicle, hardware thermal constraints, human g-load constraints, structural loads limits, and ability to achieve acceptable landing hardware criteria. In order to provide an effective system, the ascent abort capability must incorporate some type of vehicle monitoring to detect failures and, in some cases, impending failures. This requirement is in addition to the failure tolerance requirements in 3.2.3.1 and 3.2.3.2.*

### **3.3.1.5 Ascent Abort Reliability**

The CTS shall provide a pad and ascent abort system reliability of not less than 0.995 when an abort is initiated. [R.CTS.059]

*Rationale: The intent of this requirement is to design and develop a very robust abort system with high reliability of effective operation (1 failure in 200) when the system is activated. This requirement drives the system design such that the system will activate and function when needed to separate the crewed spacecraft from the launch vehicle. The scope of this requirement includes failure of the abort system to ignite and separate the spacecraft from the launch vehicle, failure to provide required thrust during the boost phase, and failure to separate from the spacecraft following the abort, if required. It is one of the inputs into the assessment of crew survivability once an abort is executed, which is determined by an integrated calculation of LOC/LOM.*

### **3.3.1.6 RESERVED**

### **3.3.1.7 Aborts outside DAEZ**

The CTS shall provide ascent aborts that result in the spacecraft landing outside the Downrange Abort Exclusion Zone (DAEZ). [R.CTS.061]

*Rationale: The DAEZ is a geographical area to be avoided for landings following launch aborts due to rough seas and cold water temperature in the North Atlantic. Additionally, landing within close proximity to land masses with pre-positioned recovery teams maximizes the probability of crew survival.*

### **3.3.1.8 Abort without Launch Vehicle Thrust**

The CTS shall perform pad and ascent aborts that separate the spacecraft from the launch vehicle without relying on thrust from the launch vehicle. [R.CTS.062]

*Rationale: Because the health of the launch vehicle cannot be guaranteed for abort situations, the spacecraft must be able to safely separate and perform ascent aborts without thrust from the launch vehicle. This does not preclude the operational use of the launch vehicle if available and desired to improve abort conditions when the launch vehicle is operating nominally.*

### **3.3.1.9 Abort on Flight Termination System Command**

If a range safety destruct system is incorporated into the design, the integrated space vehicle shall automatically initiate an ascent abort sequence when range safety destruct commands are received onboard, with an adequate time delay prior to destruction of the launch vehicle to allow a successful abort, regardless of abort system inhibits. [R.CTS.063]

*Rationale: Prior to destruction of the launch vehicle, the abort system is automatically initiated. An automated initiation of the abort sequence provides the best chance for crew survival while protecting the public from a Range Safety violation. Note: The time delay will need to be negotiated with the appropriate Range Safety Authority.*

### **3.3.1.10 Initiate Pad and Ascent Abort**

Both the crew and the CVCC shall be capable of independently initiating the pad and the ascent abort sequence. [R.CTS.064]

*Rationale: Both the crew and flight controllers in the CVCC will likely have access to more data than an automated abort system. This functionality may be utilized for non-time-critical abort/contingency decision making or abort scenarios beyond the capability of the automated system; therefore, both the crew and the flight control team will have the capability to initiate the abort when necessary for crew survival.*

## **3.3.2 Emergency Pad Egress**

### **3.3.2.1 Detect Emergency Pad Egress**

The CTS shall detect and alert the CVCC of conditions requiring an emergency pad egress. [R.CTS.065]

*Rationale: The intent of this requirement is for the launch pad, spacecraft, and launch vehicle to be able to detect hazardous conditions, such as explosive hazards caused by propellant leaks, exterior fires, or significant systems failures in the launch vehicle, spacecraft, or launch pad infrastructure that threaten the safety of the crew. Detectors may include infrared sensors, UV fire detectors, high resolution video, hazardous gas detection systems, etc., to augment telemetry data provided by the launch vehicle, spacecraft, and pad GSE. This data is passed to the CVCC so that the appropriate leadership of the flight/ground control team can assess the danger and make a decision to egress the ground and flight crew, if required.*

### **3.3.2.2 Ground and Flight Crew Emergency Pad Egress**

The CTS shall provide emergency egress for all required ground crew and the flight crew on the launch support structure ending at a pre-coordinated collection point outside the blast danger area during pre-launch activities. Emergency egress will be based on the time required to respond to the hazard and does not preclude an intermediate stop at a designated safe location within the blast danger area. [R.CTS.066]

*Rationale: For contingency situations, where additional ground crew is not immediately available in the white room to assist, all flight crew plus the ground crew involved in crew strap-in and hatch closure will need the capability to evacuate the launch pad for safety reasons. This requirement can work in conjunction with requirement 3.2.5.12, which ensures that the crew can egress the spacecraft unassisted or 3.5.1.2 which provides for assisted vehicle egress. This requirement should drive design of the launch structure, spacecraft*



*access platforms/arms, launch structure emergency safety systems, and evacuation routes in the pre-launch orientation, pad perimeter access gates, and transportation to a pre-coordinated collection point to allow the ground and suited flight crew to egress without external ground crew assistance. In some cases, the emergency egress plan may include a stop at a designated safe location inside the blast danger area until an imminent hazard has been resolved. The pre-coordinated collection point is a location outside of the blast danger area where medical stabilization can occur and should be based on direction of the downwind corridor created by the hazard on launch day. NASA will perform medical stabilization and transportation from the pre-coordinated collection point to a Definitive Medical Care Facility (DMCF).*

### **3.3.3 Range Safety**

#### **3.3.3.1 Alert Crew of Flight Termination**

The integrated space vehicle shall alert the crew upon receipt of arm and destruct Flight Termination System (FTS) command. [R.CTS.069]

*Rationale: If flight termination is required for the launch vehicle, an ascent abort separating the spacecraft from the explosion hazard will automatically occur. This requirement provides for an indication to the crew that the FTS command has been sent and an immediate ascent abort is about to transpire.*

#### **3.3.3.2 Range Safety Program Compliance**

The CTS shall meet NPR 8715.5A, Range Flight Safety Program. [R.CTS.350]

*Rationale: NPR 8715.5A identifies the requirements to be placed on NASA programs, projects, and centers for the protection of the general public, workforce, and assets during vehicle flight activities. While mostly a responsibilities and process requirements document, it does contain a number of design driving requirements that must be met. It should be noted that the NPR is tailorable by NASA and also provides a waiver process in the event that requirements cannot be met or where an equivalent level of safety cannot be achieved. In addition, other range-specific safety requirements, such as AFSPCMAN 91-710, may apply and will be satisfied to that Authority. This NPR contains requirements that apply to U.S. commercial space vehicles and foreign space vehicles when carrying a NASA payload and/or NASA astronauts and the operation is not conducted under a Federal Aviation Administration (FAA) commercial launch operator license or foreign government range/public safety authority. This NPR does not apply if an operation is conducted under an FAA license or under foreign government range/public safety authority, unless specified by the applicable contract or agreement.*

### **3.3.4 Launch Support System**

#### **3.3.4.1 Protection from Lightning**

The CTS shall prevent direct attachment of lightning to the integrated space vehicle while on the ground with 95% or greater probability of success with 90% confidence. [R.CTS.073]

*Rationale: The effects of lightning strikes on the launch vehicle and spacecraft can be mitigated with appropriate operational plans and design techniques.*

### 3.3.4.2 Accommodate NASA Personnel at CVCC

The CTS shall accommodate 4 mission essential NASA personnel at the CVCC with capability to monitor the pre-launch and mission operations activities and communicate with NASA personnel in ISS MCC-H. [R.CTS.071] [I]

*Rationale: Consoles, IT support, communication (including voice loops), displays, telemetry, etc., for monitoring pre-launch and mission operations at the CVCC are essential for NASA personnel participating in the agreed-to decision making process for commit to launch and monitoring real-time mission operations. The 4 NASA personnel will include a Program representative, a flight surgeon, and representatives from crew, mission operations, or other technical support.*

## **3.4 Onorbit**

### **3.4.1 Contingency**

#### **3.4.1.1 Emergency Return from ISS**

The CTS shall provide emergency return of all CTS-delivered crewmembers from the ISS within 24 hours from the time that the decision to return has been made. [R.CTS.106] [I]

*Rationale: Emergency return can be invoked in the event of an ISS or medical emergency. Depending on the emergency, the return may require a targeted landing to facilitate rescue. The 24 hours provide an aspect of global coverage under the ground track to enable optimal flight performance for return to a landing site, and may enable expedited rescue when necessary. In the event of a declared emergency return, all crewmembers that arrived on the spacecraft must return with it so that they do not lose assured return capability after vehicle departure. In the case of a medical return, medical assets required to support an ill or injured crewmember's return will displace nominal payload, as necessary. For the purposes of this requirement, deorbit waive-off requirements (3.4.2.4 and 3.4.2.6) are not applicable.*

#### **3.4.1.2 Undock without ISS Services**

The spacecraft shall perform all undocking and separation operations without services from the ISS. [R.CTS.076] [I]

*Rationale: For contingency undocking, the ISS may be unable to provide navigation data, attitude data, range/range rate data, or ISS power to the spacecraft; therefore, the spacecraft must be self-sufficient to complete the undocking and associated separation tasks. The driving scenarios are likely a decision to undock during a safe haven or in the event of loss of service for 24 hours to the spacecraft.*

#### **3.4.1.3 Autonomous Deorbit**

The spacecraft shall have the capability to autonomously target and perform a deorbit, entry, and landing from orbital insertion through end of mission in the event of early mission termination. [R.CTS.086]

*Rationale: The crew should be able to terminate the mission with no assistance from the CVCC allowing a return to earth. This is a complementary requirement to requirement 3.3.1.4, which ensures ascent abort autonomous operation and return. This requirement covers scenarios that could cause an early mission termination beginning with orbital insertion.*

### **3.4.2 Spacecraft Operations and Durations**

The total system endurance is to be specified by the CTS Provider and is dependent upon rendezvous and landing strategies; however, the requirements in this section drive the endurance by protecting for operations that ensure adequate margin for resolving issues. A notional endurance timeline can be found in Appendix P for reference.

#### **3.4.2.1 Docking 24 hours after Launch**

The spacecraft shall dock with the ISS 24 hours after launch while supporting a 190 degree rendezvous phase window. [R.CTS.078] [I]

*Rationale: Allowing for docking 24 hours after launch provides for a launch availability of at least 6 acceptable launch opportunities in 14 days due to phasing. This is based on an*

*assumed timeline utilizing 19 hours for phasing and 5 hours for fixed operations (ascent through orbital insertion and terminal rendezvous) along with 185 km (100 nm) delta altitude variations, which provides 190 degrees of phasing. The CTS may provide additional time beyond the 24 hours timeframe for rendezvous phasing in order to increase launch availability. On a mission-by-mission basis, docking times may occur earlier than 24 hours after launch, provided the crew work/rest related requirements are met in Section 3.10.10.*

#### **3.4.2.2 Multiple Approach Attempts**

The spacecraft shall maneuver to an operationally-safe standoff distance after a recoverable docking failure on the initial attempt and perform an additional approach and docking attempt 90 minutes after the initial attempt. [R.CTS.079] [I]

*Rationale: In the event that the ISS or CTS suffers a failure that delays nominal docking or if there is a recoverable failure onboard the spacecraft, consumables and vehicle capability should allow a back-out to a safe distance followed by another docking attempt 90 minutes later. On a mission-specific basis, the time of the additional docking attempt will be selected to match the failure scenario. For this requirement, 90 minutes was selected as representative of time to troubleshoot and reconfigure to clear the failure. Additionally, 90 minutes is approximately the orbital period of ISS, so lighting and some communication availability will repeat.*

#### **3.4.2.3 Support Docking Delay**

The spacecraft shall retreat to a safe distance after a second failed docking attempt and perform a final re-rendezvous, final approach, and docking attempt 24 hours after the initial attempt. [R.CTS.080] [I]

*Rationale: In the event that the second docking attempt occurring on the nominal docking crew day fails, consumables should allow a break-out to a safe distance followed by a re-rendezvous and docking on the next crew day.*

#### **3.4.2.4 Support Deorbit Delay**

The spacecraft shall delay the deorbit maneuver by a minimum of 24 hours from the planned deorbit ignition time after the first missed deorbit attempt. [R.CTS.081]

*Rationale: Consumables are used to protect for scenarios requiring waive-offs at deorbit due to landing site issues (e.g., Range goes "red", unanticipated wind gusts, etc.) or spacecraft configuration issues. It also provides some protection for extended delays due to significant systems problems, allowing time for the flight control team to understand the problem and arrive at the best entry configuration. This capability must be preserved at all times during the mission until the deorbit maneuver time. See requirement 3.4.2.6 for associated backup landing site requirement.*

*If the end-of-mission (EOM) is designed for ascending passes to the continental U.S., 24 hours allows for subsequently transitioning to ascending passes in the same general area or landing off the coast of California. To the maximum extent possible, crew sleep periods should be uninterrupted and maintained on a stable schedule to avoid performance decrements related to circadian desynchrony and/or sleep deficit.*

*Note that if a 24 hour contingency re-rendezvous or safe haven capability is not performed, those consumables can be used to extend the deorbit delay capability beyond that specified in*

*this requirement to enhance anomaly investigation time and improve landing opportunities from a crew scheduling viewpoint.*

#### **3.4.2.5 ISS Safe Haven**

The spacecraft shall provide for a hatch-closed safe haven capability while docked to the ISS for all crewmembers returning with the spacecraft:

- a. For up to 6 hours on internal spacecraft power, and
- b. For up to an additional 18 hours if ISS power is restored to the spacecraft and rendezvous contingency consumables were not previously used. [R.CTS.082] [I]

*Rationale: The spacecraft must provide a safe haven for an emergency requiring ISS evacuation, starting with the spacecraft in its nominal ISS quiescent docked configuration. It is assumed that the ISS will be capable of maintaining attitude control for this contingency, so the assumption for safe haven is that the ISS will be in the normal planned attitude. In order to support a habitable environment for all the crewmembers transported to the ISS in the spacecraft, the life support system will need to be functional in sufficient time to maintain the cabin within contingency limits upon sudden crew ingress and hatch closure. The spacecraft must provide life support (O<sub>2</sub>, N<sub>2</sub>, CO<sub>2</sub> removal, water, food, vehicle cooling, etc.) and power for 6 hours accounting for the metabolic rate of the crew. But it is possible that the emergency scenario could result in loss of power to the spacecraft. The 6 hours supports short time safe haven scenarios, such as sheltering in-place for orbital debris conjunctions. The 6 hours of safe haven contingency also provide time to address the ISS emergency, attempt to restore power to the spacecraft, and to determine if it is safe for crew to re-ingress the ISS. If the ISS is able to restore its power feed to the spacecraft and the consumables were not used to support a docking failure, the spacecraft should be able to extend the safe haven to a full 24 hours. See SSP 50808, 3.2.2.4.1.3 for ISS power provisions to the spacecraft. In the event of a fire, an attempt to recondition the ISS atmosphere will be made during this time. Requirement 3.10.11.1.3 describes a spacecraft purge capability if required for this contingency.*

#### **3.4.2.6 Alternate Landing Site**

The CTS shall provide an alternate landing site to support a deorbit delay. [R.CTS.337]

*Rationale: The alternate landing site is a supported landing site other than the designated primary landing site, but not an emergency landing site. This protects for scenarios due to nominal landing site issues (e.g., Range goes "red", unanticipated wind gusts, etc.) or spacecraft configuration issues near the time of deorbit. To the maximum extent possible, crew sleep periods should be uninterrupted and maintained on a stable schedule to avoid performance decrements related to circadian desynchrony and/or sleep deficit.*

#### **3.4.2.7 Return after Failure to Dock**

The spacecraft shall return to a supported landing site after a 24 hour docking delay and final failed docking. [R.CTS.338]

*Rationale: After the final docking attempt required in requirement 3.4.2.3, the spacecraft needs sufficient consumables to target either a nominal designated landing site or a supported alternate landing site. This does not preclude a water landing with staged crew recovery assets. The intent is to not put the crew into a survival situation for recovery for*

*this LOM scenario. To the maximum extent possible, crew sleep periods should be uninterrupted and maintained on a stable schedule to avoid performance decrements related to circadian desynchrony and/or sleep deficit. Satisfying this requirement may suggest deorbit and landing on the following crew day.*

### **3.4.2.8 Integrated System Performance with Final Successful Rendezvous**

The spacecraft shall provide the integrated system performance required to complete a mission in which the nominal and contingency operations specified in requirements 3.4.2.1, 3.4.2.2, 3.4.2.3, 3.4.2.4, 3.4.2.5, 3.4.2.6, and SSP 50808, Section 3.3.11.1.5 occur within the same mission.

[R.CTS.375]

*Rationale: This stressing design mission represents the set of known operational contingencies that, when protected for, presents a reasonable risk posture for mission success. This mission scenario includes a second docking attempt on the nominal docking day, contingency rendezvous, safe haven, safe without services, and deorbit waive-off. Each of these situations by themselves presents unique challenges, but the full complement must be protected serially so that the CTS will have the reserve necessary to proceed should a problem be encountered. ISS will provide supplemental power for 48 hours after a contingency mating per SSP 50808. Although a safe haven or safe without services event per SSP 50808 could occur during this window, the CTS is not being required to fully support these contingencies during this timeframe due to the low probability of occurrence. Individual requirements in Section 3.4.2 are verified independently, whereas this requirement is verified as a complete mission set.*

### **3.4.3 Orbital Debris**

#### **3.4.3.1 Expendable Module Disposal**

The CTS shall meet NASA-STD-8719.14, Process for Limiting Orbital Debris. [R.CTS.083]

*Rationale: Man-made orbital debris is one of the top hazards for human space flight in terms of the LOC risk; therefore, it is NASA's policy, in cooperation with other space faring nations, to dispose of expendable modules and other orbital debris to avoid catastrophic damage to other crewed and uncrewed spacecraft.*

#### **3.4.3.2 Collision Avoidance**

The CTS shall perform collision avoidance with trackable orbital debris during the pre-launch timeframe and during onorbit free-flight operations.

Note: Docked collision avoidance will be handled by the MCC-H ISS flight control team.  
[R.CTS.084]

*Rationale: The intent of this requirement is to have the CTS protect the crew from collision with trackable orbital objects. Prior to launch, the predicted insertion and early operations trajectory will be screened against conjunctions and if a high risk event is identified the launch can be delayed. While onorbit, a translational maneuver is required when the risk to the crew exceeds a predefined threshold. NASA has a well-established process for identifying conjunctions and will do so for the commercial crew vehicle using the Probability of Collision ( $P_c$ ) method to identify high risk conjunctions since it allows high risk events to be mitigated without causing unnecessary launch cutouts or maneuvers.*

## **3.5 Entry/Landing Requirements**

### **3.5.1 Nominal**

#### **3.5.1.1 RESERVED**

#### **3.5.1.2 Assisted Vehicle Egress**

The CTS shall provide for assisted vehicle egress. [R.CTS.344]

*Rationale: In a post-landing deconditioned state or in a pre-launch or pad abort contingency, the crew may require assistance to egress the spacecraft. If the crew is incapacitated or deconditioned, the recovery/rescue team may be required to extract the crew; therefore, accommodations, such as mobility aids and external hatch controls for recovery/rescue personnel, must be planned for at landing and pre-launch.*

#### **3.5.1.3 Visual Aids for Search and Rescue/Recovery**

The spacecraft shall provide visual aids for search and rescue/recovery in all ambient lighting conditions. [R.CTS.088]

*Rationale: Visual aids (e.g., flashing light beacons and dye bags) are necessary in rescue/recovery operations in all ambient lighting conditions to facilitate locating the vehicle and crew. The visual landing aids should be designed to operate in all lighting conditions, since the vehicle will be capable of landing in all ambient lighting conditions. Additionally, the system should be operable in all the weather conditions (wind, rain, ceiling, sea state, etc.) that the vehicle has been designed to land in. This system should include multiple methods to aid the search and rescue/recovery forces in locating the spacecraft. Examples include flashing light beacons/strobe lights, visual markers such as sea dye or smoke, along with high color contrast of portions of the spacecraft such as parachutes, uprighting bags, or special paint markings.*

#### **3.5.1.4 Post-Landing Crew Services**

The CTS shall provide the post-landing services of drinking water (immediately accessible by the crew in their landing configuration), breathable atmosphere per 3.10.11.1.1 b,d, and cooling per 3.2.5.11.5 for the crew, for 2 hours after landing at a supported site. [R.CTS.090]

*Rationale: If the crew is deconditioned and is physically unable to egress the spacecraft, then the spacecraft provides a habitable environment until the arrival of the recovery team. The nominal end-of-mission entry will have well established timelines and expectations for the habitation conditions inside the spacecraft. The time requirement for recovery team to recover the crew at a supported landing site is approximately 1 hour. The provision of 2 hours of post-landing services would provide some additional margin, and can be met with a combination of spacecraft and ground servicing equipment located at the supported landing sites. During the recovery phase, the crew is expected to remain in their seats under nominal conditions due to their deconditioned state with minimal tasking.*

#### **3.5.1.5 Orthostatic Protection**

The CTS shall provide orthostatic protection to the crewmember with a lower body compression garment from the ankle to the top of the waist, which is considered the part of the abdomen between the bottom of the ribcage and the hips. The minimum pressure applied shall be 40 mmHg and the maximum pressure applied shall be 80 mmHg. [R.CTS.091]

*Rationale: Orthostatic intolerance is a well-described consequence of space flight, and prevention is needed to protect crew health and minimize operational impacts. Symptoms and consequences of orthostatic intolerance include dizziness, confusion, and loss of consciousness, which may result in an inability to operate controls, complete mission critical tasks, and egress from the vehicle without assistance. Thus, without appropriate mitigation, a crewmember suffering from the effects of orthostatic intolerance could jeopardize safe and successful reentry, landing, and egress, particularly in the event of an emergency before support personnel are available.*

*Mitigation strategies employed during Space Shuttle and International Space Station missions have included fluid/salt loading regimens prior to reentry to partially counteract space flight-induced losses of plasma volume, compression garments to prevent blood pooling in the lower body and abdomen, liquid cooling garments to prevent heat stress-induced orthostatic hypotension and to maintain crew comfort, and recumbent crewmember seating for long-duration crewmembers to minimize the effects of acceleration along the long axis of the body. Thus, the orthostatic protection requirement is tightly coupled with 3.2.5.11.5 Suit Accommodation of Metabolic Heat Loads and 3.10.19.5 Water for Fluid Loading, to ensure adequate cooling and water loading, respectively.*

*To improve venous return, the mean compression provided by lower body garments should be between 40 to 80 mmHg. These levels are similar to those provided by the countermeasure garments used by NASA that includes the NASA Anti-Gravity Suit and the Russian Kentavr. These have been efficacious during Shuttle and Soyuz landings. Graded pressure may be advantageous, and if used is to be applied with highest pressure at the foot/ankle, lower pressure up the leg, and lowest pressure over the abdomen to the level of the diaphragm.*

*Refer to HRP-47072 Human Research Program Evidence Book: Risk of Orthostatic Intolerance During Re-exposure to Gravity and NASA/SP-2010-3407 Human Integration Design Handbook (HIDH) paragraphs 6.5.2.2 and 6.5.2.4 for information on cardiovascular deconditioning and orthostatic intolerance due to spaceflight, and for details of extensive research performed by NASA on protective garments.*

### **3.5.1.6 Crew Egress Paths**

The CTS shall provide more than one crew egress path out of the spacecraft when in the landing configuration. [R.CTS.092]

*Rationale: For an off-nominal landing where a vehicle may be on its side, or in cases where there is an obstruction present, the primary egress path may not be useable; therefore, an alternate means of crew egress from the spacecraft should be available in order to allow the crew to reach safety in the event of emergencies in the post-landing timeframe.*

### **3.5.1.7 Communications with CVCC after Landing**

The spacecraft shall provide 2 hours of cumulative post landing two-way voice communications, over a 24 hour period, between the crew and the CVCC until recovery/rescue forces have removed the crew from the vehicle. [R.CTS.095]

*Rationale: The crew should have periodic two-way voice communications with the operations team sufficient to aid in spacecraft safing and coordinate the recovery or search and rescue and other crew survival efforts during this timeframe. The communication will need to be maintained until the search and rescue or recovery teams have recovered the crew*



*for nominal and off nominal landing scenarios. 5 minutes of continuous two-way voice every hour for 24 hours (reference requirement 3.5.2.4 Crew Survival After Landing) will satisfy search and rescue needs. This requirement does not preclude the use of portable devices as part of a strategy to provide two-way voice communications between the crew and the CVCC until recovery forces have removed the crew from the vehicle.*

### **3.5.1.8 Spacecraft Voice Communication with Recovery/Rescue Forces**

The spacecraft shall provide two-way voice communication between the crew and the recovery/rescue forces from the time the recovery/rescue forces are within direct line-of-sight of the spacecraft until recovery/rescue forces have removed the crew from the spacecraft.

- a. The spacecraft shall be capable of communicating on International Air Distress (IAD) frequency of 121.5 MHz and Military Air Distress (MAD) frequency of 243.0 MHz. [R.CTS.353]

*Rationale: The crew should have two-way voice communications with the recovery/rescue forces that will be conducting the search and rescue and other crew survival efforts during this timeframe. The communication will need to be maintained until the search and rescue or recovery teams have recovered the crew for nominal and off nominal landing scenarios. It is assumed that it will take 4 hours for the rescue and recovery forces to remove the crew from the spacecraft. The CTS should develop and coordinate other special frequencies for use beyond the IAD and MAD frequencies for all operations that are not considered search and rescue. This requirement does not preclude the use of portable devices as part of a strategy to provide two-way voice communication between the crew and recovery/rescue forces. This requirement should not require the crew to open the egress hatches to maintain communication with recovery/rescue forces because the spacecraft may be in a contingency landing situation, such as in a water landing, which would preclude opening the hatches.*

### **3.5.2 Contingency**

Note: These contingency requirements are in addition to those required for a nominal landing, as defined in Section 3.5.1.

#### **3.5.2.1 Emergency Entry Capability**

The CTS shall provide emergency systems for entry, descent, and landing (EDL) to return the crew to Earth. [R.CTS.096]

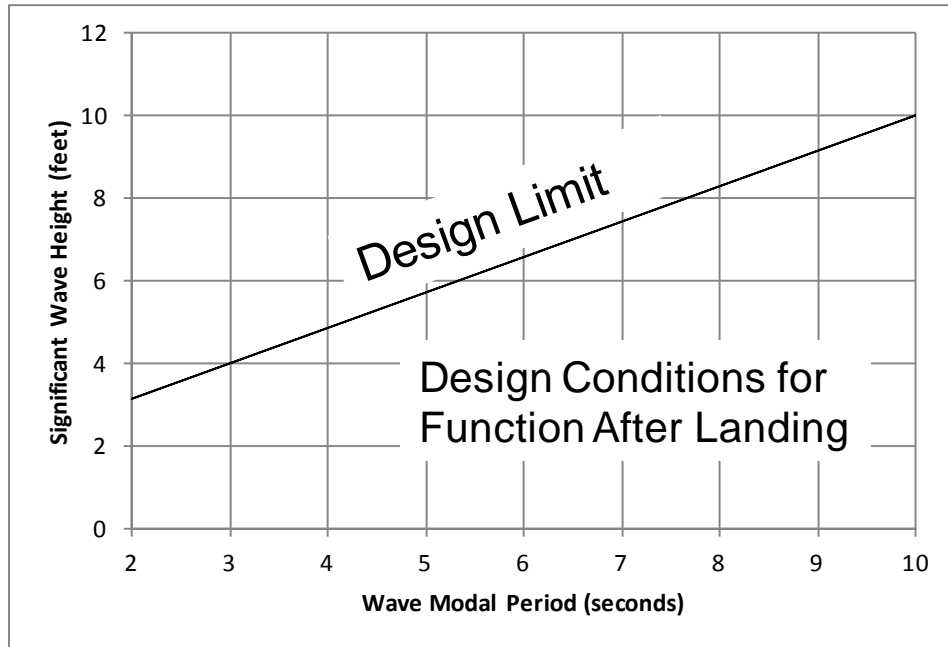
*Rationale: The intent of this requirement is to provide emergency entry, descent, and landing (EDL) system, analogous to the abort emergency system on ascent that allows for crew return to Earth in the event that the failure tolerance designed into the system is unsuccessful in controlling a potentially catastrophic hazard. The emergency systems are not required to achieve the requirements of a nominal landing at the designated landing site(s); rather, they are in place to provide a survivability path for the crew.*

#### **3.5.2.2 Sea State Landing Limits for Aborts**

The spacecraft shall function after landing in sea state conditions at the limit in Figure 3.5.2.2-1 for aborts designated for a water landing. [R.CTS.373]

*Rationale: During aborts designed for a water landing, there is a risk the spacecraft may land in hazardous sea states with degraded weather. The vehicle must be designed to land safely so that it can perform its post-landing functions and prepare for subsequent crew*

*rescue. Designing to these limits may maximize rescue opportunities. The sea state rescue conditions found in Figure 3.5.2.2-1 are based on Apollo experience and Post-landing Orion Recovery Tests (PORT) performed in 2009 with military rescue forces.*



**Figure 3.5.2.2-1: Sea State Design limits for Crew Rescue**

### 3.5.2.3 Runway Landing Weather Limits for Aborts

The spacecraft shall perform abort landings in the environmental limits in Table 3.5.2.3-1 for aborts designated for a runway landing. [R.CTS.374]

*Rationale: During aborts designed for a runway landing, there is a risk the spacecraft may land on runways with degraded weather. The landing conditions are based on current commercial aviation capabilities without differential GPS.*

**Table 3.5.2.3-1: Runway Abort Landing Weather Limits**

Condition	Limit
Ceiling	300 ft
Runway Visual Range	1 nm
Cross Winds	20 kts

#### **3.5.2.4 Crew Survival after Emergency Landing**

The spacecraft shall provide for crew survival for 24 hours after an emergency landing, while limiting core body temperature excursions above 100.5 °F but no greater than 102.6 °F for less than 45 minutes cumulative. [R.CTS.093]

*Rationale: Twenty four hours is the longest time that the ground support would take to recover the crew in an emergency landing scenario, such as an emergency deorbit scenario where landing occurs in a remote location. In harsh environments, the providers must develop a crew survivability strategy that determines crew actions and vehicle and survival kit capabilities required to transition into and operate in this survival mode. The crew expenditure of energy and minimal available cooling in remote locations make core body temperature regulation critically important to prevent heat-related illnesses. The strategy must address tasking required to safe the vehicle, doffing the suits and configuring for a sustained loiter phase while awaiting rescue. This requirement would allow for crew egress if conditions for egress were safe to do so (i.e., land landing where the crew is able to open the hatch and egress the spacecraft in a deconditioned state).*

#### **3.5.2.5 Spacecraft Ventilation for Emergency Landings**

The spacecraft shall provide cabin ventilation equivalent to 4 cabin air exchanges per crewmember per hour while crew is present after an emergency landing. [R.CTS.364]

*Rationale: A remote landing could subject the spacecraft and crew to harsh environmental conditions ranging from high atmospheric temperatures to rough seas. If the crew must remain in the vehicle, this ventilation will equalize cabin temperature, mitigate CO2 build-up, and replenish O2. The duration of this service and the variability of ventilation rates with landing environments are developed in conjunction with the crew survivability strategy in requirement 3.5.2.4.*

#### **3.5.2.6 Crew Survival Kit**

The spacecraft shall provide a crew survival kit to support all crewmembers for at least 24 hours following an emergency landing. [R.CTS.094]

*Rationale: A crew survival kit must be provided for crew health and safety. In the event of an emergency landing to an unsupported site, the crew may be sheltered in the vehicle for up to 24 hours post-landing. In addition, the crew survival kit must provide readily-accessible survival rations and equipment to support crew needs while awaiting rescue. This kit should be portable and not rely on vehicle resources for functionality such that it can be taken with crew in the event of egress. The emergency landing location and conditions are often unpredictable, thus an integrated task analysis should be performed to ensure the survival kit provides support in all potential scenarios. Guidance on the task analysis process can be found in Section 4.1 of JSC 65995, Commercial Human System Integration Processes (CHSIP). The development of a crew survival kit should include search and rescue equipment (e.g., life raft, radio, beacons, twine, knives, and a signal kit) and crew survival items (e.g., food, water, first-aid items, etc.).*

#### **3.5.2.7 Support Crew Rescue After Emergency Landing**

The CTS shall support rescue of the flight crew by NASA-designated rescue forces in the event of an emergency landing at an unsupported landing site:

- a. The CTS shall provide spacecraft-specific emergency rescue equipment to NASA-designated rescue forces.
- b. The CTS shall provide CTS-specific emergency rescue training to NASA-designated rescue forces.
- c. The CTS shall assist NASA-designated rescue with CTS assets and resources for landings in proximity to supported landing sites. [R.CTS.393] [I]

*Rationale: The government will provide augmented rescue services for emergency landings at unsupported landing sites. Note - The NASA-designated rescue forces will not retrieve the cargo or salvage the spacecraft. Spacecraft-specific rescue equipment, such as a sea anchor(s) and stabilization collar(s) are essential tools to enable a rescue at sea, providing a work platform to assist in the extraction of crewmembers. Spacecraft-specific rescue equipment to support assisted egress for land landing at non-supported sites may also be required. Equally important are attach points for attaching this equipment to the spacecraft and tethering rescue personnel or flight crew. Equipment to monitor hazardous conditions outside the spacecraft may also be required to ensure safe rescue operations. This equipment may reside on the spacecraft or may be multiple sets of ground support equipment (GSE) provided to NASA-designated rescue forces. Training specific to the CTS system will need to be provided to NASA-designated training instructors in order to identify any potential post-landing spacecraft hazards to the rescue personnel and flight crew and to define the procedures for rescue personnel to operate the spacecraft hatches and employ any provided rescue equipment. Outside of the supported landing site, NASA will consider using CTS assets and resources planned for nominal landings to determine the scope and needs of the NASA-designated rescue forces. NASA-designated rescue forces will assist in crew egress from the spacecraft, may perform medical stabilization, and may provide transportation to a DMCF.*

### **3.5.3 Post-Landing Recovery**

#### **3.5.3.1 Recovery after Nominal Landing**

The CTS shall recover the NASA flight crew, including their removal from the spacecraft, within 1 hour of landing at a supported landing site(s). [R.CTS.097] [I]

*Rationale: The recovery time starts with touchdown and ends with the assisted crew removal from the spacecraft. It is unreasonable to expect the crew to remain in the spacecraft for an extended period of time in a deconditioned state without medical attention. For most landings, it is reasonable for the crew to safe the vehicle and be recovered within one hour after touchdown.*

#### **3.5.3.2 RESERVED**

#### **3.5.3.3 RESERVED**

#### **3.5.3.4 RESERVED**

#### **3.5.3.5 Recovery Lighting at Supported Sites**

The CTS shall perform recovery operations at supported sites in all ambient lighting conditions. [R.CTS.101]

*Rationale: The CTS is responsible for recovering the crew at all supported landings, in day or night lighting conditions to maximize landing opportunities at supported sites, which is*

*required due to the future ISS traffic models with resupply occurring from a multitude of vehicles.*

### **3.5.3.6 NASA Personnel Accompanying Recovery**

The CTS shall provide transportation and delivery of 30 NASA personnel and their equipment from a CTS-designated staging location to the supported landing site. [R.CTS.102] [I]

*Rationale: Transportation must be provided for NASA landing support personnel and government furnished equipment (GFE) hardware/equipment/supplies (such as crew health unique supporting hardware and supplies and payload-unique ground and flight hardware) to travel from a mutually agreed CTS-designated staging location (which may include sites on land, such as a continental US Airport, or water) to the supported landing site. The complement of NASA personnel transported to the landing site may be different for each mission but will not exceed 30 people. NASA personnel include flight surgeons and nurses to provide medical care for each NASA-sponsored crewmember, Program Management, and other required personnel to assist the crew and handle time-critical cargo in the post-landing timeframe. The number of personnel required could be slightly higher for baseline data collection and/or additional time-critical cargo requirements.*

### **3.5.3.7 Transport NASA Personnel and Cargo from Landing Site**

The CTS shall provide transportation and delivery of the NASA crew, returning ISS time-critical cargo, 30 NASA personnel, and equipment to transfer to NASA at a continental U.S. airport within 2 hours after the completion of the NASA medical assessment at a supported landing site using air transportation or transportation appropriate to landing site conditions.

- a. The CTS shall maintain cargo services post-landing per SSP 50833, Section 3.1.1. [R.CTS.103] [I]

*Rationale: When NASA flight surgeons determine NASA crew readiness post landing, CTS personnel transports the NASA crew, personnel, their equipment, and returning time-critical cargo to a continental U.S. airport within two hours. At the airport, CTS personnel assist with loading NASA crew, personnel, their equipment, and returning time-critical cargo onto the NASA-provided transportation. The two hour window, after completion of the NASA medical assessment, for transport to the airport is part of the overall timeline to ensure timely return of NASA crew for baseline data collection and preservation of time-critical cargo.*

### **3.5.3.8 Contingency Medical Evacuation**

The CTS shall provide medical evacuation capability at supported landing sites to return ill or injured crewmembers to a DMCF within 1 hour of crew egress. The medical evacuation capability shall include the following:

- a. One physician trained and proficient in Advanced Trauma Life Support (ATLS) per medical evacuation vehicle
- b. One Paramedic for each patient aboard the medical evacuation vehicle(s)
- c. Two NASA personnel to support crewmembers once arrived at DMCF [R.CTS.104] [I]

*Rationale: Nominal landings can turn into contingency events with no predictability. It is critical the CTS plan for full medical coverage and that the evacuation provisions are the same at all supported landing sites. In the event of a contingency at a supported landing site,*

*medical evacuation may be needed to transport ill or injured crewmembers to the appropriate medical care facility, normally a DMCF, in a timely manner. It is imperative that critical medical resources are on station at the supported landing site prior to the scheduled landing time ready to respond to unpredictable events whereby an expected nominal landing becomes a contingency with little or no notice. These medical resources should be close enough in proximity to the landing site to respond to a medical need within a reasonable timeframe. Extraction of injured crewmembers may delay medical evacuation and subsequent arrival at the DMCF. A trained physician is the best option for coordinated medical care involving multiple casualties and single point communication of relevant casualty assessment until arrival at the DMCF. Including one trained physician per medical evacuation vehicle plus a paramedic for each patient aboard the medical evacuation vehicle brings a greater medical capability in the shortest time to those injured and allows advanced treatment closer to the time of injury. Medical personnel need to have appropriate medical certification, a minimum level of training to support contingencies and need to understand the effects of space flight. The two NASA personnel, comprised of a NASA Flight Surgeon and Interpreter/Management, will assist the ill/injured crewmember at the DMCF.*

### 3.6 Crew Health Support

#### 3.6.1 RESERVED

#### 3.6.2 Medical Hardware Interfaces

The spacecraft shall provide emergency medical oxygen to interface with ISS-provided respiratory equipment (per Table 3.6.2-1) used during the return of an ill or injured crewmember until egress. [R.CTS.318] [I]

*Rationale: The ISS Program has accepted the results of Integrated Medical Model analyses to determine and rank order the probabilities of medical conditions that would result in the medical return of an ISS crewmember. The top 10 diagnoses were used to establish medical hardware needs for crewmember support during return. In addition to medications and small items that would not require vehicle scarring, supplemental oxygen supplied by the returning vehicle is required to support ISS medical hardware used during the return. It must interface with standard ISS medical equipment that regulates the actual pressure and flow rate of oxygen delivered to the crewmember.*

**Table 3.6.2-1 Medical Hardware Interfaces**

Physical Interface	per drawing SEG33105312 (or equivalent)
Supply pressure, flowrate, and temp to respiratory equipment	up to 6 slpm of medical oxygen at 55–103 degF and 65-120 psia
Supply pressure, flowrate, and temp from respiratory equipment to spacecraft cabin	up to 6 slpm of medical oxygen at 70–90 degF at ambient pressure

#### 3.6.3 Privacy of Health and Medical Data

The CTS shall ensure the privacy of all crew health and medical related data. [R.CTS.107]

*Rationale: Provisions of the Privacy Act of 1974, as amended, regarding control of records, information exchange, and release of crewmember health information to the public will be strictly followed. Communications pertaining to an individual's health care will be private as regulated by the controls, regulations, provisions, and penalties of the Privacy Act of 1974. Privacy is required to protect against unintentional distribution of private downlink crew medical and personal data.*

#### 3.6.4 Health Stabilization

The CTS shall meet JSC 22538, Flight Crew Health Stabilization Program. [R.CTS.109] [I]

*Rationale: A Health Stabilization Program (HSP) minimizes NASA ISS crew exposure to pre-flight illness and reduces the chance of launch delays, crew replacement, or decrements to mission performance due to crew illness. As part of this program, a health awareness campaign is initiated 30 days prior to launch to make non-flight crewmembers, families, and co-workers aware of the provisions of the HSP to help guard against the spread of infectious disease during the HSP period.*

## **3.7 Commercial Vehicle Control Center (CVCC)**

### **3.7.1 Ground Monitoring and Operation**

The CTS shall provide the capability for ground personnel to remotely monitor, operate, and control the integrated space vehicle and subsystems from the CVCC(s), where:

- a. The remote capability is necessary to execute the mission.
- b. The remote capability would prevent a catastrophic event.
- c. The remote capability would prevent an abort. [R.CTS.110]

*Rationale: Logically, there will be times when a remote capability to monitor, operate and control the integrated space vehicle and subsystems is required to augment crew activities. Additionally, ground personnel may need this capability because they have access to more data than the crew, augmented analysis capabilities, or information that may not be readily available onboard, such as landing site weather and other ground infrastructure status information.*

*This capability is not intended to force 100% communication coverage for all elements of the system. Unless specified in Section 3.8.1, the communication coverage will be planned to implement the capability to meet the three conditions listed above.*

### **3.7.2 RESERVED**

### **3.7.3 CVCC/MCC-H Data Integration**

The CVCC shall exchange data with the NASA ISS MCC-H to enable real-time mission support. [R.CTS.112] [I]

*Rationale: The NASA ISS Flight Control team will require telemetry, voice, video, and trajectory data to execute the joint mission in partnership with the CVCC. Real-time operations include pre-launch and post-landing.*



## **3.8 Spacecraft**

### **3.8.1 Communications**

#### **3.8.1.1 Voice Communication with Crew**

The CTS shall provide single failure tolerant two-way voice communication between the CVCC (s) and the spacecraft crew from pre-launch through landing and during aborts. [R.CTS.113]

*Rationale: Two-way voice communication between the CVCC (s) and the crew is required to execute the mission and resolve anomalies should they occur. The intent of this requirement is to provide single failure tolerance in both the ground and onboard communications systems in order to ensure communications availability during all flight phases. This requirement is not meant to imply 100% continuous communication for all phases of flight. Onorbit communications coverage requirements will be dictated by the specific design requirements of the spacecraft.*

#### **3.8.1.2 Communications Coverage**

The CTS shall provide communications coverage (two-way voice and telemetry) between the integrated space vehicle and CVCC(s) during at least 90% of the powered ascent flight phase and 65% during the entry flight phase to supported landing sites. [R.CTS.114]

*Rationale: Historically, the ascent and entry phases of human space flight have been the timeframe of greatest risk for LOC. For powered ascent, there are a multitude of abort options and timely systems responses that ground personnel can assist with leading to the requirement near continuous communications that can be accommodated by ground and/or space based communication assets. For entry, although the risk is high, there are fewer options available for the crew and thus the requirement for continuous communication is less than that for ascent. Entry communications coverage to supported landing sites is intended to limit the number of trajectories for nominal entry assessment. The entry communication analysis should be focused on critical events (separations, chute deployment key navigation events) and the final phase of landing where the risk is the highest.*

#### **3.8.1.3 RESERVED**

#### **3.8.1.4 Private Audio**

The CTS shall provide for a private audio communications capability between the NASA crew and the NASA flight surgeon during non-docked, onorbit operations. [R.CTS.116]

*Rationale: This secured or private communication provides for privacy of medical information between the NASA crew and the NASA flight surgeons per the Privacy Act of 1974. Private voice communications are not required during ascent and entry due to the short nature of these flight phases. Voice communications are considered private with respect to those on the ground. No additional impacts to vehicle design should result from establishing private communication, as the information is not required to be private between crewmembers.*

#### **3.8.1.5 Integrated Voice Communications during ISS Proximity and Docked Operations**

The CTS shall provide simultaneous two-way voice communications between the ISS, CTS spacecraft, CVCC, and ISS Mission Control Center during:

- a. Free flight when the CTS spacecraft is within 10 kilometers of the ISS.

- b. Docked operations when the crew is in the CTS spacecraft. [R.CTS.117] [I]

*Rationale: The intent of this requirement is to supplement other requirements in this document (3.7.3 and 3.8.1.1) and in SSP 50808 so that the CTS enables a multi-party voice loop conferencing the ISS, CTS spacecraft, CVCC, and ISS Mission Control Center when the CTS spacecraft is within 10 kilometers of the ISS to support nominal and contingency operations. This requirement includes providing voice communication when the crew is isolated in the CTS spacecraft while attached to ISS (i.e., Safe Haven). This requirement enables conferencing of all the operations entities (ISS crew, CTS spacecraft crew, CVCC flight control team, and ISS flight control team) to support proximity and docking operations. This does not require direct point-to-point communication between all parties.*

### **3.8.1.6 RESERVED**

#### **3.8.1.7 Command and Telemetry Communications**

The CTS shall provide single failure tolerant command and telemetry communication between the integrated space vehicle and the CVCC(s) from pre-launch through landing and during aborts. [R.CTS.351]

*Rationale: Command and telemetry communication between the CVCC (s) and the crew is required to execute the mission and resolve anomalies should they occur. The intent of this requirement is to provide single failure tolerance in both the ground and onboard communications systems in order to ensure communications availability during all flight phases. This requirement is not meant to imply 100% continuous communication for all phases of flight. Onorbit communications coverage requirements will be dictated by the specific design requirements of the spacecraft.*

#### **3.8.1.8 Communication**

The CTS shall satisfy communications performance in the expected operating environment and ensure compatibility with existing users of the same spectrum. [R.CTS.380]

*Rationale: Radio frequency spectrum is a shared commodity and therefore, design parameters for a radio communication system with consideration of the expected radio frequency environment are essential. Maintaining communications performance in the expected operating environment and compatibility with existing spectrum users delivering of the minimum required data through the communications link during phases of flight where coverage is required. It is also important to ensure that other NASA Systems and users are not impacted by the implementation of the CTS frequency links and modes.*

### **3.8.2 Command Link Security**

Note: These requirements apply to any command link with the vehicle during all phases of flight.

#### **3.8.2.1 Advanced Encryption Standards**

The CTS shall secure hardware and software implementation of the decryption and encryption for all commands, excluding FTS commands. The system shall implement Federal Information Processing Standard (FIPS) Publication 197, Advanced Encryption Standard (AES), or available NSA-endorsed and NIST-certified TDEA crypto module, for all encrypted data exchanges. [R.CTS.122]

### 3.8.2.2 Requirements for Cryptographic Modules

The CTS shall perform cryptographic operations using devices that meet FIPS Publication 140-2, Security Requirements for Cryptographic Modules, Level 2 Certification. [R.CTS.123]

### 3.8.2.3 Cryptographic Key Management

The CTS shall manage cryptographic keys in accordance with the National Institute of Standards and Technology (NIST) SP 800-57, Recommendation for Key Management-Part 1 and with NASA COMSEC Office of Record located at the NASA Kennedy Space Center. [R.CTS.124]

*Rationale: The Command Link Security Section requirements are necessary to protect the command link to spacecraft and launch vehicle so that unauthorized commanding with the potential for catastrophic results cannot occur.*

## 3.8.3 Onorbit Maintenance

### 3.8.3.1 Preventative Maintenance

The CTS shall have no more than 2 crew hours of Intravehicular Activity (IVA) preventative maintenance every 30 days during ISS docked operations. [R.CTS.126] [I]

*Rationale: ISS crew time is reserved for science and other operations. The spacecraft design should minimize the amount of maintenance required to avoid impacts to the ISS crew productivity.*

### 3.8.3.2 Maintenance Tools

The CTS shall provide all unique tools required for onorbit maintenance and reconfiguration. [R.CTS.127]

*Rationale: In general onorbit maintenance should be avoided, but if needed, tool design should be based on selecting tools that are familiar to crewmembers and minimizing the number of different tools. Also, tools are to be usable by the full range of crew sizes and strengths wearing expected protective equipment (protective eyewear, gloves, etc.). Use of the ISS tools should be considered for the mission phase when the spacecraft is attached to the ISS. The ISS available tools list can be found in SSP 41000 System Specification for the International Space Station Table XLVIII Standard IVA Tool List and Table XLIX IVA Diagnostic Equipment List.*

## 3.8.4 Manual Control

### 3.8.4.1 Manual Control of Vehicle Flight Path

The spacecraft shall provide the capability for the crew to manually control the vehicle flight path, attitude, and attitude rates during all actively controlled phases of flight following the separation of the spacecraft from the launch vehicle, excluding ISS mated operations. [R.CTS.128]

*Rationale: The capability for the crew to control the spacecraft's flight path is a fundamental element of crew survival. Manual control means that the crew can bypass the automated guidance of the vehicle to interface directly with the flight control system to affect any flight path within the capability of the flight control system. Limiting the crew to choices presented by the automated guidance function is not a valid implementation of manual control. Manual control does not mean the capability to bypass the flight control system. Also, for phases of flight where there is no active control of the spacecraft, such as when under*

*passive parachutes, then manual control cannot be provided and this requirement would not apply. During highly dynamic launch abort engine firings, following spacecraft separation from the launch vehicle, where thermal, structural, or control margins are low, this requirement is not applicable; however, this requirement is applicable to abort engine firings where margins and dynamics allow safe manual control.*

### **3.8.4.2 Manual Piloting for Docking**

The spacecraft shall provide for crew manual piloting within the ISS approach ellipsoid to perform docking. [R.CTS.385] [I]

*Rationale: Crew manual piloting to accomplish docking is a means to mitigate the risk of LOM. In the event an automated docking system is used, manual piloting would ensure dissimilar redundancy. Manual piloting means that the crew can bypass the automated guidance of the vehicle to interface directly with the flight control system to affect any flight path within the capability of the flight control system for maneuvers within the approach ellipsoid. In order to safely accomplish these maneuvers, the pilot must have the necessary flight data and visual cues. Without manual docking, the crew will be forced to abort their mission and potentially re-fly the mission at additional crew risk and program cost if failure(s) rendered an automated system unavailable.*

### **3.8.4.3 Handling Qualities**

The spacecraft shall exhibit Level 1 handling qualities (Handling Qualities Rating (HQR) 1, 2 and 3), as defined by the Cooper-Harper Rating Scale, during manual control of the spacecraft's flight path and attitude during all mission phases, beginning with spacecraft separation from the launch vehicle and including ISS proximity/docking operations, when manual control is the primary control mode or automated control is non-operational.

- a. The spacecraft shall exhibit Level 2 or better handling qualities (HQR 1- 6), in all other scenarios. [R.CTS.129]

*Rationale: Level 1 handling qualities are the accepted standard for manual control of flight path and attitude in military aircraft. Level 1 handling qualities will allow the crew to effectively control the spacecraft when necessary for mission completion or to prevent a catastrophic event. Non-operational is defined as automated control system failed or not enabled.*

*Selected manual control scenarios that must meet Level 1 handling qualities will be defined via review of potential manual control scenarios. A scenario includes one or more handling quality related vehicle control tasks performed during a flight phase under specified conditions. A handling quality related task is defined as the manual control capability that is being rated with the Cooper-Harper Rating Scale (see Appendix L). Guidance on the assessment of vehicle handling qualities and the use of the Cooper-Harper scale can be found in Section 4.6 of JSC 65995, Commercial Human System Integration Processes (CHSIP). Handling qualities must be provided in accordance with NPR 8705.2B, Section 3.4.2.*

### **3.8.4.4 Windows for Crew Tasks**

The spacecraft shall provide windows that are available for use by the crew through all phases of flight that provide direct, non-electronic, through-the-hull viewing and the unobstructed fields-of-view necessary to perform crew viewing tasks. [R.CTS.177]

*Rationale: Windows provide direct, non-electronic, through-the-hull viewing and are essential to mission safety and success, as well as to maintaining crew situational awareness and psychological and physical health and safety. They do not have the failure modes associated with cameras and display systems that may not be operable during emergencies when most needed and are essential for piloting and photography. They also permit stellar navigation, vehicle anomaly detection and inspection, and environmental and scientific observations. NASA experience is that two piloting windows are required to achieve the field of view necessary to accomplish the breadth of piloting tasks. Because of the criticality of windows to crew safety and success of the mission, windows must be a part of the spacecraft design and available through all flight phases without obstructions to their use. Fixed equipment, such as window instrumentation, hardware, or a condensation prevention system, that would obstruct or obscure the field-of-view of the window from the normal crew viewing position will interfere with crew tasks and must not be placed within the sight lines through the window; however, the following are not considered obstructions: hardware used in conjunction with piloting, such as a head's up display (HUD), crew optical alignment system (COAS), or other similar equipment; the outer mold line and hull structure of the vehicle itself; other windows and window mullions; and instrumentation applied to the window itself within 13 mm (~0.5 in.) of the perimeter of the clear viewing area. For detailed design considerations for inboard and outboard window view obscuration exclusion zones, consult Sections 8.6.3.3 and 8.6.3.4 in NASA/SP-2010-3407, Human Integration Design Handbook (HIDH), which also provides extensive guidance for window design considerations.*

### **3.8.5 Crew Interface**

#### **3.8.5.1 General Crew Interfaces**

##### **3.8.5.1.1 Crew Control of Vehicle**

The integrated space vehicle shall provide the capability for the crew to monitor, operate, and control the integrated space vehicle and subsystems, where:

- a. The capability is necessary to execute the mission.
- b. The capability would prevent a catastrophic event.
- c. The capability would prevent an abort. [R.CTS.130]

*Rationale: This capability flows directly from the definition of certifying the integrated space vehicle to function with the crew during all flight phases. Within the context of this requirement, monitoring is the ability to determine where the vehicle is, its condition, and what it is doing. Monitoring helps to create situational awareness that improves the performance of the human operator and enhances the mission. Determining the level of operation over individual functions is a decision made separately for specific space systems. Specifically, if a valve or relay can be controlled by a computer, then that same control could be offered to the crew to perform that function; however, a crewmember probably could not operate individual valves that meter the flow of propellant to the engines, but the function could be replaced by a throttle that incorporates multiple valve movements to achieve a desired end state (reduce or increase thrust). Meeting any of the three stated conditions invokes the requirement. The first condition recognizes that the crew performs functions to meet mission objectives and, in those cases, the crew is provided the designated capabilities. This does not mean that the crew is provided these capabilities for all elements of a mission.*

*Many considerations are involved in making these determinations, including capability to perform the function and reaction time. The second and third conditions recognize that, in many scenarios, the crew improves the performance of the system and that the designated capabilities support that performance improvement. It is recognized that there are situations where it is not feasible to provide the crew the capability to prevent an abort. For example, during ascent aborts, the time to detect an abort condition and activate the abort system may be less than the time for the crew to evaluate the condition, make a determination they must prevent an abort, and then perform the necessary tasks to prevent the ascent abort.*

#### **3.8.5.1.2 Tolerate Inadvertent Action**

The CTS shall be designed to tolerate inadvertent operator action (minimum of one inadvertent action), as identified by the human error analysis for all mission phases to include operations planned for response to system failures, without causing a catastrophic event. [R.CTS.131]

*Rationale: An operator is defined as any human that commands or interfaces with the space system during the mission, including humans in the control centers. The appropriate level of protection (i.e., one, two, or more inadvertent actions) is determined by the integrated human error and hazard analysis.*

#### **3.8.5.1.3 Controls for Human Error**

The CTS shall implement controls to human error according to the following precedence:

- a. Prevent human error in the maintenance, operation, and control of the system.
- b. Reduce the likelihood of human error and provide the capability for the human to detect and correct or recover from the error.
- c. Design the system to limit the negative effects of errors. [R.CTS.132]

#### **3.8.5.1.4 Tolerate Inadvertent Action during Failure**

The CTS shall tolerate inadvertent operator action, as described in requirement 3.8.5.1.2, in the presence of any single system failure. [R.CTS.134]

*Rationale: The intent of this requirement is to provide a robust human system interface design that cannot be defeated by a system failure. Where the system is designed to protect for more than one inadvertent action, the level of protection after a single system failure may be reduced, but still protects from a single inadvertent operator action. In addition, this ensures that back-up capabilities, such as back-up flight software, maintain the same-level of tolerance to human error as the primary system.*

#### **3.8.5.1.5 Operable by Single Crewmember**

The spacecraft shall be operable by a single crewmember for operations that require crew control. [R.CTS.135]

*Rationale: The vehicle must be designed so that mission events can be completed by a single crewmember. In addition, vehicle design for single crewmember operations drives operations simplicity and contributes to operations affordability. This requirement results from lessons learned from the Shuttle cockpit, which had critical switches that are out of the operator's reach zone and software that requires more than one crewmember to perform a nominal operation. This requirement does not preclude provision of multiple crew stations for backup and crew resource management (CRM) operations.*

## **3.9 Spacecraft and Launch Vehicle Design Manufacturing Standards**

### **3.9.1 Materials and Processes**

#### **3.9.1.1 Materials and Processes**

The CTS shall meet the intent of NASA-STD-6016, Standard Materials and Processes Requirements for Spacecraft. Deviations from materials and processes requirements shall be documented and approved using the intent of the Materials Usage Agreement (MUA) as defined in NASA-STD-6016. [R.CTS.260]

#### **3.9.1.2 Cabin Materials Flammability**

The spacecraft shall use materials in the pressurized cabin that meet the flammability requirements of NASA-STD-6016 in 30% oxygen at a pressure of 10.2 psia. [R.CTS.376]

*Rationale: The most severe environment for material flammability will be 30% O<sub>2</sub> at a pressure of 10.2 psia. The cabin depressurization event is the bounding case with respect to flammability for all cabin operating pressures.*

### **3.9.2 Flight and Ground Software**

#### **3.9.2.1 Software Engineering Requirements**

The CTS shall meet the intent of NPR 7150.2A, NASA Software Engineering Requirements for all flight and ground software products classified as Class A software per Appendix E of NPR 7150.2A, or safety critical as defined in NASA-STD-8719.13, Appendix A, that adversely affects the operation of the Class A products. A requirements mapping matrix is provided for each software class and criticality in Appendix D of NPR 7150.2A. [R.CTS.262]

### **3.9.3 Electrical and Avionics**

#### **3.9.3.1 Use of Silver**

##### **3.9.3.1.1 Electrically Deposited Silver**

The CTS shall not use electrically deposited silver as plating on printed wiring boards and terminal boards because of potential dendrite growth. [R.CTS.266]

##### **3.9.3.1.2 Silver Plating**

The CTS shall not use silver plating on bus bars and mechanical electrical contacts, such as connector pins and sockets, because it can tarnish and degrade electrical conductivity. [R.CTS.267]

#### **3.9.3.2 RESERVED**

#### **3.9.3.3 Printed Wiring Boards**

##### **3.9.3.3.1 Printed Board Design Standards**

The CTS shall meet the intent of the requirements defined in IPC-2221, Generic Standard on Printed Board Design, as well as the associated technology performance specification under the IPC-2220 series per Performance Class 3. [R.CTS.268]

### **3.9.3.3.2 Qualification of Printed Boards Standard**

The CTS shall meet the intent of the requirements defined in IPC-6011, Generic Performance Specification for Printed Boards, as well as the associated technology performance specifications of the IPC-6010 series per Performance Class 3 (and Class 3/A). [R.CTS.269]

### **3.9.3.3.3 Conductor Size Standard**

The CTS shall meet the intent of the requirements defined in IPC-2152, Standards for Determining Current Carrying Capacity in Printed Board Design per Performance Class 3. [R.CTS.270]

### **3.9.3.4 Printed Wiring Assemblies**

#### **3.9.3.4.1 Printed Wiring Assemblies**

Electrical circuitry shall be designed and fabricated to prevent the production of unwanted current paths by debris or foreign materials floating in the spacecraft microgravity environment. [R.CTS.271]

### **3.9.3.5 Fiber Optics**

#### **3.9.3.5.1 RESERVED**

[R.CTS.272]

#### **3.9.3.5.2 Fiber Optic Connection Standard**

The CTS shall meet the intent of NASA-STD-8739.5, Fiber Optic Terminations, Cable Assemblies, and Installation. [R.CTS.273]

### **3.9.3.6 Staking/Conformal Coating**

#### **3.9.3.6.1 Staking/Conformal Coating**

The CTS shall meet the intent of the requirements in NASA-STD-8739.1, Workmanship Standard for Polymeric Application on Electronic Assemblies. [R.CTS.274]

### **3.9.3.7 Electrical Soldering**

#### **3.9.3.7.1 Soldering Process and Controls Standard**

The integrated space vehicle shall meet the intent of IPC J-STD-001ES, Space Applications Electronic Hardware Addendum and IPC J-STD-001E, Requirements for Soldered Electrical and Electronic Assemblies. [R.CTS.275]

#### **3.9.3.7.2 RESERVED**

#### **3.9.3.7.3 Soldering Performance Standard**

The CTS shall meet the intent of GEIA-STD-0005-1, Performance Standard for Aerospace and High Performance Electronic Systems Containing Lead-Free Solder. [R.CTS.277]

#### **3.9.3.7.4 Mitigation of Tin Whiskers**

The CTS shall meet the intent of GEIA-STD-0005-2, Standard for Mitigating the Effects of Tin Whiskers in Aerospace and High Performance Electronics. [R.CTS.278]



### **3.9.3.8 Electrical Crimping**

#### **3.9.3.8.1 Wiring, Cables, Harnesses and Crimping**

The CTS shall meet the intent of NASA-STD-8739.4; however, terminal lugs, splices, and two-piece shield termination rings shall meet the tensile strength and electrical requirements of SAE-AS-7928, General Specification for Terminals, Lug: Splices, Conductor: Crimp Style, Copper. [R.CTS.279]

### **3.9.3.9 Electrical Wire Wrapped Connections**

#### **3.9.3.9.1 Electrical Wire Wrapped Connections**

The integrated space vehicle shall not use wire wrapping. [R.CTS.280]

### **3.9.3.10 Electrical Bonding**

#### **3.9.3.10.1 Electrical Bonding**

The integrated space vehicle equipment, subsystems, and systems shall be designed, manufactured, and integrated to meet the intent of NASA-STD-4003, Electrical Bonding for NASA Launch Vehicles, Spacecraft, Payloads, and Flight Equipment. [R.CTS.281]

### **3.9.3.11 Batteries**

#### **3.9.3.11.1 Batteries**

The integrated space vehicle battery systems shall meet the intent of the requirements defined in JSC 20793, Crewed Space Vehicle Battery Safety Requirements. [R.CTS.282]

### **3.9.3.12 Other Processes**

#### **3.9.3.12.1 RESERVED**

#### **3.9.3.12.2 Component Mounting Guidelines**

The CTS shall meet the intent of IPC-CM-770E, Component Mounting Guidelines for Printed Boards per Performance Class 3. [R.CTS.284]

### **3.9.3.13 Integrated Space Vehicle Electrostatic Charge Control**

#### **3.9.3.13.1 LEO Charging Design Standard**

The spacecraft shall meet the intent of the requirements contained in NASA-STD-4005, Low Earth Orbit Spacecraft Charging Design Standard. [R.CTS.285]

#### **3.9.3.13.2 Electrostatic Discharge Control Program**

The CTS shall meet the intent of ANSI/ESD S20.20, Protection of Electrical and Electronic Parts, Assemblies, and Equipment (Excluding Electrically Initiated Explosive Devices), which will include establishing and maintaining an electrostatic discharge control program. [R.CTS.286]

#### **3.9.3.13.3 Electrostatic Design Thresholds**

The CTS shall meet the intent of IEC 61000-4-2, Electromagnetic Compatibility (EMC) Testing and Measurement Techniques-Electrostatic Discharge Immunity Test for Human Body Model (HBM) subassemblies, assemblies and equipment discharge levels, which do not apply to electrically-initiated explosive devices. [R.CTS.371]

### **3.9.3.14 Electromagnetic Interference Control**

#### **3.9.3.14.1 Electromagnetic Interference Control**

The integrated space vehicle equipment, subsystems, and systems shall be designed, manufactured, and integrated to meet the intent of MIL-STD-461, Requirements for the Control of Electromagnetic Interference Characteristics of Subsystems and Equipment. [R.CTS.287]

### **3.9.3.15 Electromagnetic Environmental Effects**

#### **3.9.3.15.1 Electromagnetic Environmental Effects**

The integrated space vehicle equipment, subsystems, and systems shall be designed, manufactured, and integrated to meet the intent of the MIL-STD-464, Electromagnetic Environmental Effects Requirements for Systems. [R.CTS.288]

### **3.9.3.16 Custom Electromagnetic Devices**

#### **3.9.3.16.1 Custom Electromagnetic Devices**

The integrated space vehicle equipment, subsystems, and systems shall be designed, manufactured, and integrated to meet the intent of MIL-STD-981, Design, Manufacturing, and Quality Standards for Custom Electromagnetic Devices for Space Applications. [R.CTS.289]

### **3.9.3.17 Lightning**

#### **3.9.3.17.1 Lightning Protection Design**

The integrated space vehicle equipment, subsystems, and systems shall be designed, manufactured, and integrated to meet the intent of the requirements contained in the following documents in order to provide protection from the direct and indirect effects of the natural lightning environment, including triggered lightning:

- a. SAE ARP 5412A, Aircraft Lightning Environment and Related Test Waveforms.
- b. FAA AC 20-136B, Protection of Aircraft Electrical/Electronic Systems Against the Indirect Effects of Lightning.
- c. SAE ARP 5414A, Aircraft Lightning Zoning.
- d. SAE ARP 5577, Aircraft Lightning Direct Effects Certification. [R.CTS.290]

### **3.9.4 Aerodynamic Deceleration Systems**

#### **3.9.4.1 Trailing Deployable Aerodynamic Decelerator**

##### **3.9.4.1.1 Trailing Deployable Aerodynamic Decelerator Design**

The integrated space vehicle shall meet the intent of JSC 65985, Requirements for Human Spaceflight for the Trailing Deployable Aerodynamic Decelerator (TDAD) during the design and development of parachute and other similar systems. [R.CTS.291]

### **3.9.5 Mechanisms**

#### **3.9.5.1 Mechanism Design**

The integrated space vehicle shall meet the intent of NASA-STD-5017, Design and Development Requirements for Mechanisms. The following sections are not applicable: 4.7,

Fastener Retention and 4.8.9, Preload Bolt Criteria (refer to requirement 3.9.8.3 for fastener requirements). [R.CTS.292]

### **3.9.6 Thermal Protection System (TPS)**

#### **3.9.6.1 Thermal Protection System (TPS) Design**

The spacecraft TPS shall meet the intent of JSC 65827, Thermal Protection System Design Standard for Spacecraft. [R.CTS.293]

#### **3.9.6.2 TPS Structural Design**

The integrated space vehicle TPS shall meet the intent of structural requirements per Section 3.9.8. [R.CTS.372]

### **3.9.7 Pyrotechnics**

#### **3.9.7.1 Pyrotechnics**

The CTS shall meet the intent of JSC 62809, Human Rated Spacecraft Pyrotechnic Specification. [R.CTS.294]

### **3.9.8 Structures**

#### **3.9.8.1 Structural Design and Factors of Safety**

##### **3.9.8.1.1 Structural Design Requirements**

All flight hardware structures of the integrated space vehicle, except for glass or ceramic windows, shall meet the intent of JSC 65828, Structural Design Requirements and Factors of Safety for Spaceflight Hardware. [R.CTS.295]

##### **3.9.8.1.2 Windows Design**

The integrated space vehicle shall meet the intent of NASA-STD-5018 for window systems that utilize glass or ceramic panes. The following sections of NASA-STD-5018 are not applicable for commercial crewed vehicles: 4.6.3 and 5.6.3, 4.10.2 and 5.10.2. For window systems (or portions of window systems) that use non-brittle materials such as plastic panes refer to requirement 3.9.8.1.1 of CCT-REQ-1130. [R.CTS.296]

#### **3.9.8.2 Loads and Structural Dynamics**

##### **3.9.8.2.1 Loads and Structural Dynamics**

The integrated space vehicle shall meet the intent of JSC 65829, Loads and Structural Dynamics Requirements for Spaceflight Hardware. [R.CTS.297]

##### **3.9.8.3 Fasteners**

The integrated space vehicle shall meet the intent of NASA-STD-5020, Requirements for Threaded Fastening Systems in Spaceflight Hardware. [R.CTS.298]

### **3.9.9 Fluids, Propellants, Explosives, and Oxygen Systems**

#### **3.9.9.1 Flexible Lines and Flow-Induced Vibration**

The CTS shall prevent flow-induced vibration (FIV) in metal bellows and flexhoses over their operating flow range +/-10% or show that part life is 4 times the operational life when FIV cannot be eliminated.

- a. The FIV analysis to determine the predicted FIV flow range shall be performed to meet the intent of MSFC-DWG-20M02540, Assessment of Flexible Lines for Flow-Induced Vibration.
- b. The procedures for flow testing metal bellows and flexhoses to show acceptable operational life shall meet the intent of MSFC-SPC-626, Test Control Document for Assessment of Flexible Lines for Flow Induced Vibration.
- c. For those metal bellows and flexhoses used in the CTS which experience an operating flow excitation environment that is different (atypical) than the grazing flow environment described by MSFC-DWG-20M02540, then an alternative analysis technique shall be used. [R.CTS.303]

*Rationale: The occurrence of flow-induced vibrations in convoluted metal bellows and flexhoses can result in a structural fatigue failure. These flow-induced vibrations are a result of the coupling of vortex shedding from the flexible line convolutes with the natural frequencies of the flexible line. It is the intent of this requirement to avoid those flow ranges which produce FIV or to pursue other robust design and demonstration activities necessary to minimize the likelihood of a catastrophic failure of bellows and flexhoses. The alternative analysis technique is meant to address flow situations where the MSFC-DWG-20M02540 would not be applicable.*

### **3.9.10 Propulsion Systems**

#### **3.9.10.1 Strength and Life Requirements for Propulsion Systems**

The integrated space vehicle shall meet the intent of NASA-STD-5012, Strength and Life Assessment Requirements for Liquid Fueled Space Propulsion Systems Engines. [R.CTS.304]

### **3.9.11 Fracture Control**

#### **3.9.11.1 Fracture Control**

The integrated space vehicle shall meet the intent of fracture control requirements in NASA-STD-5019, Fracture Control Requirements for Spaceflight Hardware. [R.CTS.307]

### **3.9.12 Parts**

#### **3.9.12.1 Parts**

The CTS shall meet the intent of the part selection criteria established in the SMC Standard SMC-S-010, Space and Missile Systems Center Standard, Parts, Materials, and Processes Technical Requirements for Space and Launch Vehicles. [R.CTS.319]

### **3.9.13 Testing**

#### **3.9.13.1 Ground Testing**

The integrated space vehicle and associated subsystems and units shall meet the intent of the environmental and structural ground testing requirements as defined in SMC Standard SMC-S-016, Test Requirements for Launch, Upper-Stage, and Space Vehicles. [R.CTS.315]

### **3.9.14 Models and Simulations**

#### **3.9.14.1 Models and Simulations**

The CTS shall meet the intent of sections 4.1.1, 4.1.2, 4.7 and 4.8 of NASA-STD-7009 for all models and simulations that are utilized in making critical decisions. [R.CTS.381]

*Rationale: The intent is to ensure that the limitations and credibility of model- and simulation-based analysis results are clearly and consistently communicated to decision makers, since the output data from a model or simulation by itself does not provide sufficient information on which to base a critical decision.*

### **3.10 Human Health, Medical and Performance**

The requirements in Section 3.0 work in conjunction with the human system interface design requirements in Appendix Q. These Appendix Q requirements apply to component-level implementation, human interface performance requirements, and design rules. A traceability matrix is provided in Appendix Q to show relationships between the design requirements and the parents they support. The parents can be found in any part of Section 3.0. The requirements in Appendix Q can either be allocated "as is" in the Provider's specification or tailored to satisfy the parent requirement. Appendix Q is invoked by requirement 3.10.1.

#### **3.10.1 Human Interface Design Standards**

The CTS shall meet the intent of the human system interface design requirements in Appendix Q. [R.CTS.343]

#### **3.10.2 Crew Acceleration and Vibration Limitations**

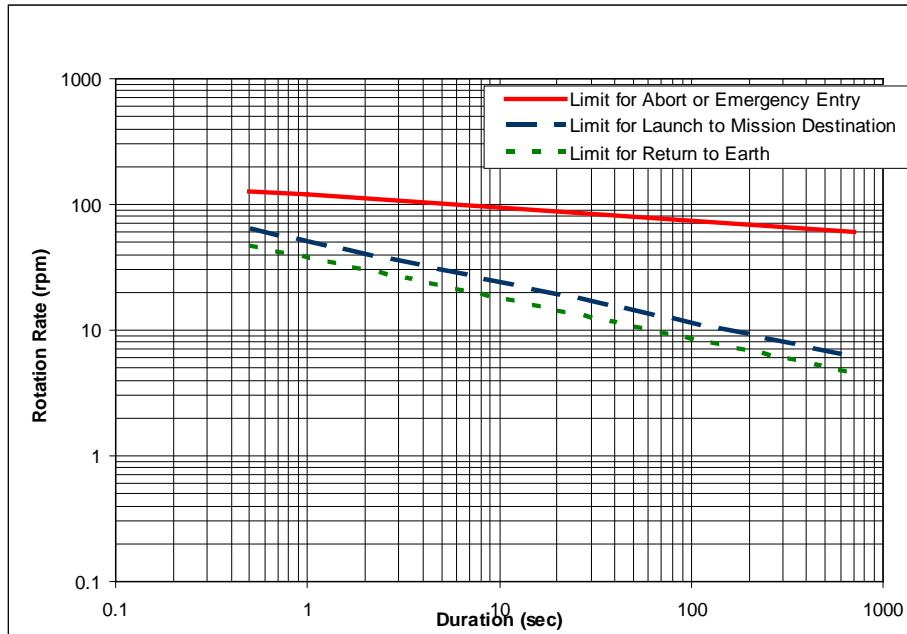
##### **3.10.2.1 Sustained Translational Acceleration Limits**

The CTS shall limit the magnitude, direction, and duration of crew exposure to sustained (> 0.5 seconds) translational acceleration by staying below the limits specified in Appendix H, Figures H-2, H-3, H-4, H-5, and H-6. [R.CTS.216]

*Rationale: These limits represent safe levels of sustained translational acceleration for crewmembers under nominal and off-nominal conditions. The limits for entry (return to Earth) are lower than launch limits because crewmembers could have degraded capabilities because of deconditioning from exposure to reduced gravity. The lower entry limits also accommodate returning ill or injured crewmembers. For the extreme conditions of a launch abort or emergency entry, limits are higher because it may be necessary to expose the crew to accelerations more severe than those experienced nominally in order to return them safety to Earth. Crewmembers are never to be exposed to sustained translational acceleration rates greater than these elevated limits, as this significantly increases the risk of crew incapacitation, threatening crew survival. Each axis needs to be analyzed separately.*

### 3.10.2.2 Rotational Velocity Limits

The CTS shall limit crew exposure to rotational velocities in yaw, pitch, and roll by staying below the limits specified in Figure 3.10.2.2-1. [R.CTS.217]



**Figure 3.10.2.2-1 Rotational Velocity Limits**  
**Data for Figure 3.10.2.2-1**

(sec)	Abort Rotation Rate (rpm)	Design Limit-Nominal (rpm)	Design Limit - Deconditioned
0.5	129	63	47
1	120	50	37.5
700	60	6	4.5

### 3.10.2.3 Sustained Cross-Coupled Rotational Acceleration

The CTS shall prevent the crew from being exposed to sustained (>0.5 seconds) cross-coupled rotational accelerations greater than 2 rad/s<sup>2</sup>. [R.CTS.218]

*Rationale: Crewmembers are not expected to be able to tolerate sustained cross-coupled rotational accelerations in excess of 2 rad/s<sup>2</sup> without significant discomfort and disorientation. Sustained cross-coupled rotational accelerations exceeding this amount have been found to significantly impact human performance (e.g., neurovestibular performance via the "coriolis effect," physical reach, and cognition in Stone, R.W., & Letko, W. (1965)).*

### 3.10.2.4 RESERVED

### 3.10.2.5 Acceleration Rate of Change

The CTS shall prevent the crew from being exposed to a rate of change of acceleration of more than 500 g/s during any sustained acceleration event. [R.CTS.220]

*Rationale: Acceleration onset rates greater than 500 g/s significantly increase the risk of crew incapacitation, thereby threatening crew survival.*

### **3.10.2.6 Health Limits for Vibration during Dynamic Phases of Flight**

The CTS shall limit vibration to the crew such that the vectorial sum of the X, Y, and Z frequency-weighted accelerations between 0.5 and 80 Hz is less than or equal to 0.4 g rms over a 10-minute period and 0.6 g rms over a one-minute period. [R.CTS.221]

*Rationale: There is limited data on the effects of high levels of vibration on health. It is expected that internal organs and tissue structures could be damaged if the level of vibration or the time period for these levels were increased. Studies were conducted in the 1960s to evaluate human tolerance to higher levels of vibration between 3 and 20 Hz for exposures lasting less than 5 minutes (Temple et al, 1964). These studies were conducted in the controlled laboratory environment with subjects supported by a rigid single-component space couch. A multiple component, non-rigid support may increase the risk of injury to the spinal column. In the semi-supine space couch configuration, the sustained accelerative forces (i.e., constant G-load bias equal to 1.0 G) are directed through the X-axis (back to chest) of the occupant.*

*The main focus of complaints was pain or pressure in the thorax and difficulty with respiration. Discomfort was also reported in the abdomen and head. The 0.6-g weighted rms level falls in the vicinity of the upper boundary of the ISO 2631-1:1997, Annex B, Figure B.1 Health Guidance Caution Zones for a 1-minute exposure occurring during a 24-hour period. Above this boundary, health risks are likely. Below this boundary, caution for the potential for health risks is indicated. However, it should be noted that some individuals involved in the studies conducted by Temple et al were unable to withstand vibration at the 0.6-g rms level for frequency components between 10 and 20 Hz because of severe discomfort. The 0.4-g weighted rms level for 10-minute exposure, however, is within the tolerance levels reported by Temple, et al (1964) for the frequencies between 3 and 20 Hz. The 0.4-g weighted rms level falls between the upper and lower boundaries of the ISO Standard 2631-1:1997, Annex B, Figure B.1 Health Guidance Caution Zones, where caution should be taken with regard to the potential for health risk.*

### **3.10.3 Dynamic Flight Occupant Protection**

This section presents the requirements for occupant protection in order to control hazards and limit injury risk presented by excessive crew loads due to high accelerations or insufficient crew restraint, particularly during landing or other dynamics flight scenarios such as ascent abort initiation. Additional hazard modes that may threaten occupant safety are structural failure or encroachment of hardware into the occupant volume, especially during off-nominal landing events.

#### **3.10.3.1 Brinkley Dynamic Response Model**

The CTS shall limit the injury risk criterion,  $\beta$ , to no greater than 1.0 for aborts and landings according to the Brinkley Dynamic Response model, utilizing Low DR level limits during nominal landings and Medium DR Level limits for off-nominal landings and abort events as defined in Table 4.3.10.3.1-1. [R.CTS.224]

*Rationale: The Brinkley Dynamic Response model will provide an injury risk assessment during dynamic phases of flight for accelerations less than 0.5 seconds. This model is used*



*for landing scenarios, but it is applicable for all dynamic phases of flight for accelerations less than 0.5 second. Application of the Brinkley Dynamic Response model is described in NASA TM-2013-217380, The Use of a Vehicle Acceleration Exposure Limit Model and a Finite Element Crash Test Dummy Model to Evaluate the Risk of Injuries During Orion Spacecraft Landings. As explained in Table 4.3.10.3.1-1, non-deconditioned crew should be used to select the dynamic response limits (DR) for aborts. For nominal and off-nominal landings, deconditioned crew should be used to select the dynamic response limits.*

### **3.10.3.2 Limitation of Crew Injury**

The CTS shall prevent injury to crewmembers due to blunt force trauma, point loads, flail, and injurious forces to the body including the head and neck during dynamic phases of flight.  
[R.CTS.225]

*Rationale: Upon landing impact, hardware and/or structure is likely to shift, deform, become projectiles, or otherwise impact the crew, potentially causing injury. Further, load paths that are not well distributed upon the occupant concentrate forces on the body to cause blunt force trauma, deep tissue damage, or other injurious force to the body. Likewise, crewmember limbs, if not restrained, may flail and impact vehicle structure, the crewmember's body, or other crewmembers. Unrestrained crewmember limbs may also present injury risks due to dangers such as joint hyperextension or hyper flexion. Impact with the crew may be injurious even if crew restraint and load attenuation is sufficient to allow crew survival. A volume surrounding the crewmember's body must be maintained without significant intrusion in order to minimize injuries. Implementation of protection against these hazards must not impede egress or vehicle operation. Head and neck protection was specifically cited as a critical area of protection by NASA/SP-2008-565 Columbia Crew Survival Investigation Report.*

### **3.10.3.3 RESERVED**

### **3.10.4 Crew Interface Requirements**

A crew interface is any part of a system through which static and dynamic information is exchanged between the crew and the system. Crew interfaces can be hardware, software, procedures or any combination. Crew interfaces should be designed for usability and consistency.

Usability optimizes crew safety and productivity. Usable interfaces are effective, efficient, and rated high on crew satisfaction. Usability is ensured through structured usability testing with crew, using representative hardware, software, procedures, and tasks. Objective data (completion times and errors) and subjective data (questionnaires, ratings, and comments/redesign recommendations) should be collected.

Consistency minimizes design-induced errors and training requirements. Consistency should be assessed through use of heuristic evaluations and consistency scales. An example of consistency is a display standard that specifies the design characteristics of displays such as layout, style, color, size, fonts, etc. and standard icons and symbols.

This section provides requirements for a broad category of design elements commonly referred to as “displays and controls.” A display is anything that provides visual, auditory, or haptic information to crewmembers (e.g., label, placard, procedure, software display, or auditory speech

or tone). A control is anything that accepts crewmember commands or inputs, whether hardware or software. In general, controls should be designed such that the shape and size do not hinder operation of the control itself. A human-centered design approach should be used to design the display and control layout to accommodate the user in the flight environment including any special considerations such as protective equipment worn by the crew. The comprehensive NASA standards for crew interface design can be referenced in JSC 65993, Commercial Human-Systems Integration Requirements (CHSIR), Section 10.0.

A human-centered design approach, as referenced in Section 3.1 of JSC 65995, Commercial Human System Integration Processes (CHSIP), should be used to design the display and control layout to accommodate the user in the flight environment including any special considerations such as protective equipment worn by the crew. Additionally, guidance on design and evaluation of crew interfaces can be found in Section 4.12 of the CHSIP, and control and display panel labeling guidance can be found in Section 4.13 of the CHSIP.

#### **3.10.4.1 Crew Interface Usability**

The spacecraft shall provide crew interfaces that have a minimum average satisfaction score of 85 as measured by the System Usability Scale (SUS) in Appendix L. [R.CTS.138]

*Rationale: Crew satisfaction with the user interface is an essential component of the usability of the system. Satisfaction is commonly assessed by asking participants to rate various aspects of their perception of the system, such as ease of learning the system and frustration level. The SUS (Brooke, 1996) is a validated scale used to determine the subjective usability of and satisfaction with a system. The maximum score achievable is 100. The SUS can be found in Appendix L, Figure L.3-1. More detailed information on the system usability scale and crew satisfaction as a part of usability assessment can be found in Section 4.2 of JSC 65995, Commercial Human Systems Integration Processes (CHSIP). Guidance on the crew task analysis process can be found in Section 4.1.*

#### **3.10.4.2 Crew Interface Workload**

The spacecraft shall provide crew interfaces that result in Bedford Workload Scale ratings of 3 or less for nominal tasks and 6 or less for off-nominal tasks. [R.CTS.139]

*Rationale: Application of workload measurement for crew interface and task designs in conjunction with other performance measures (such as error rates) helps assure safe, successful, and efficient system operations by the crew. Workload assessments need to be performed continuously throughout the design process using multi-dimensional tools such as NASA-TLX as an integral part of human-centered design. Guidance on the assessment of workload during the design cycle and as part of verification can be found in Section 4.3 of JSC 65995, Commercial Human Systems Integration Processes (CHSIP), including Figure 4.3.2.1-1, The Bedford Scale. Information on crew task analysis process can be found in Section 4.1. Workload can be decreased by modifying designs to use cues on interfaces, display information in groups, and arrangements that support task flow, and provide efficient display navigation. Evaluations of crew workload are required per NPR 8705.2B, Section 2.3.9.*

#### **3.10.4.3 Operability of Controls**

The spacecraft shall provide controls that are operable by a crewmember in their flight configuration. [R.CTS.340]

*Rationale: The proper design of controls is critical for successful spacecraft operation and mission success. Important features of control design include control shape, location, consideration of use environment (including accelerations, vibrations, and suited, pressurized operation), feedback, labeling (that is legible under use conditions), inadvertent actuation protection, display-control movement compatibility, and supports. These features enhance the crew's ability to successfully actuate controls in their use configuration and environment. In order to adequately design (displays and) controls, a human-centered design process must be implemented. A description of human-centered design process and principles can be found in Section 3.1 of JSC 65995, Commercial Human Systems Integration Processes (CHSIP).*

#### **3.10.4.4 Design Induced Crew Errors**

The spacecraft shall provide crew interfaces that result in a maximum of 5% erroneous task steps per participant, where each erroneous task step is committed by 10% or fewer participants. [R.CTS.335]

*Rationale: For optimal safety and productivity, software and hardware crew interfaces must support crew performance with minimal errors. Errors may lead to significant timeline impacts or task failure; therefore errors can cause loss of efficiency, effectiveness, and satisfaction. An erroneous task step is defined as a task step with one or more design-induced errors. A design-induced error is an intentional action that does not reach its intended goal due to design issues. Examples of errors that may be design-induced include: missed or incorrect inputs or selections, display navigation errors, errors due to inadequate hardware component design, errors due to lack of system feedback to user inputs, errors due to design inconsistency or unfamiliar terminology, and inability to complete a task step. Recoverable design-induced errors still negatively impact crew performance in terms of time and satisfaction; thus, they are included in error calculations. Unintentional errors that are related to human reliability, that is, bumping a control due to fatigue, are not covered by this requirement. Usability assessments need to be performed throughout the design process and are an integral part of human-centered design. Usability evaluations are required per NPR 8705.2B, Section 2.3.10. More detailed information on evaluating error rate as a part of usability assessment can be found in Section 4.2 of JSC 65995 CHSIP. Note that these error rate calculations are intended to reduce design-induced risk by encouraging iterative testing against error boundaries; statistical confidence increases with an increase in the number of subjects/tests.*

#### **3.10.4.5 Emergency Annunciations**

The spacecraft shall provide visual and auditory annunciations to the crew for emergency, warning, and caution events per Section 9.4.4.3 of SSP 50005, International Space Station Flight Crew Integration Standard. [R.CTS.142]

*Rationale: Off-nominal events are divided into the following three categories: emergencies, warnings, and cautions. Distinct audio annunciations and visual indications should be utilized for each class and made consistent between the ISS and spacecraft throughout the mission to simplify training and improve user comprehension. Section 9.4.4.3 defines off-*

*nominal events for these categories, including priority and annunciation, for each alert type. The use of both visual and auditory sensory modalities is provided for redundancy.*

#### **3.10.4.6 Annunciator Test**

The spacecraft shall test for a failure of the visual and auditory annunciators on request. [R.CTS.143]

*Rationale: Situational awareness and safety require a capability to test the Caution and Warning system. The crew must be aware as soon as possible when the Caution and Warning annunciation system cannot be relied upon. Examples include a light test or smoke alarm test button.*

#### **3.10.4.7 Protect for Inadvertent Operation**

The spacecraft shall protect against inadvertent operation of controls. [R.CTS.149]

*Rationale: This requirement allows for the design to preclude inadvertent operation. For example, accidental activation by bumping can be prevented by the use of guards, covers, and physical separation from other controls. Accidental activation of commands using a computer display can be prevented with an "arm-fire" mechanism. This requirement is not intended to prevent operators from initially selecting the wrong control. The system needs to ensure the crew can recover from inadvertent input with minimal impact by incorporating the capability for undoing control input.*

#### **3.10.4.8 Annunciator Intelligibility**

The CTS shall utilize an auditory speech annunciator or communications system that provides a level of speech intelligibility equivalent to a 90% word identification rate under expected ambient noise levels for all phases of flight. [R.CTS.119]

*Rationale: This requirement ensures that auditory speech annunciations and communications are sufficiently salient and intelligible. ANSI S3.2-2009, American National Standard Method for Measuring the Intelligibility of Speech over Communicating System is a widely accepted standard for measuring the intelligibility of speech communications.*

### **3.10.5 Acoustics**

#### **3.10.5.1 Acoustics Limits for Launch, Entry, and Abort**

##### **3.10.5.1.1 24-Hour Noise Exposure Limit**

The CTS shall limit the noise exposure at the crewmember's ear, calculated over any 24-hour period, to 100% or less during launch and entry including ascent abort. The 24-hour noise dose, D, is calculated by:

$$D = 100 \sum_{n=1}^N \frac{C_n}{T_n},$$

Where:

N = the number of noise exposure events during the 24-hour period

C<sub>n</sub> = the actual duration of the exposure event in minutes

T<sub>n</sub> = the maximum noise exposure duration allowed, based on the specific sound level (L<sub>n</sub>) of an exposure event in dBA, and calculated using the following equation:

$$T_n = \frac{480}{2^{(L_n - 85)/3}}$$

[R.CTS.228]

*Rationale: A noise dose of  $D=100$  is equivalent to an 8-hour, 85 dBA time-weighted average (TWA) using a 3-dB exchange rate. Equivalent noise exposure levels above 85 dBA for more than 8 hours have been shown to increase the risk of noise-induced hearing loss. The above formulae can be used to calculate the 24-hour noise exposure levels based on the 8-hour 85 dBA criterion recommended by National Institute for Occupational Safety and Health (NIOSH), using the 3-dB trading rule.*

#### **3.10.5.1.2 Launch/Entry SPL Limit**

The CTS shall limit the maximum A-weighted overall SPL at the crewmember's ear to 105 dBA or less during launch and entry, and 115 dBA or less during ascent abort. [R.CTS.229]

*Rationale: Noise levels above 115 dBA have been shown to produce noise-induced hearing loss. In cases where audio communications are required (such as during launch and entry), a 105 dBA limit is required to allow 10 dB of headroom for alarms and voice communications.*

#### **3.10.5.1.3 Impulse Noise Limit - Ear**

The CTS shall limit impulse noise at the crewmember's ear to less than 140 dB peak overall SPL during launch and entry including ascent abort. [R.CTS.230]

*Rationale: Impulse noise is a burst of noise that is at least 10 dB above the background noise and exists for one second or less. A limit of 140 dB peak SPL for impulse noise prevents trauma to the hearing organs caused by impulse noise (MIL-STD-1474D Department of Defense Design Criteria Standard, Noise Limits).*

#### **3.10.5.1.4 Infrasonic Noise Limit**

The CTS shall limit infrasonic overall SPL at the crewmember's head location for frequencies from 1 to 20 Hz to less than 150 dB. [R.CTS.231]

*Rationale: The 150-dB limit for infrasonic noise levels in the frequency range from 1 to 20 Hz provides for health and well-being effects. The noise attenuation effectiveness of hearing protection or communications headsets may not be used to satisfy this requirement, Ref.: 2001 American Conference of Governmental Industrial Hygienists, Threshold Level Values (TLVs), "Infrasound and Low-Frequency Sound."*

#### **3.10.5.2 Acoustic Limits for the Orbit and Post-Landing Phases**

The noise attenuation effectiveness of hearing protection or communications headsets may not be used to satisfy the following requirements: Q.1.2 and Q.1.3

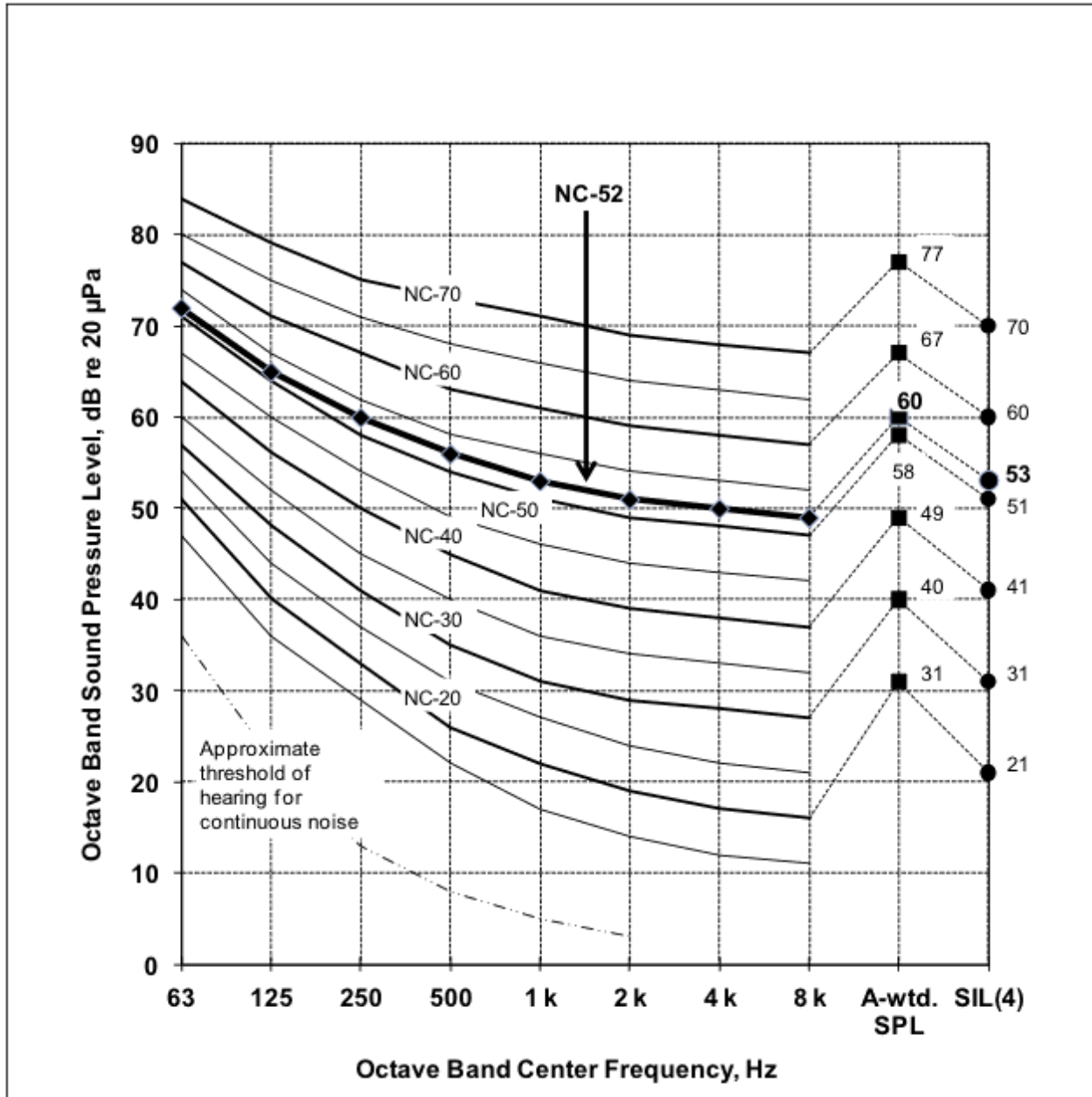
##### **3.10.5.2.1 Noise level for Communication**

The spacecraft shall limit the Sound Pressure Levels to enable effective crew communication.

- a. The assessed SPLs shall be created by the sum of all simultaneously operating equipment including active Payloads and Government Furnished Equipment throughout the crew habitable volume.

- b. The SPLs averaged over any 20-second measurement period shall be limited to the values given by the Noise Criterion (NC)-52 curve shown in Figure 3.10.5.2-1 and Table 3.10.5.2-1 during all mission phases except launch, entry, and aborts.
- c. This limit does apply to intermittently operated hardware, unless the hardware is specified in the intermittent noise requirement Q.1.2. [R.CTS.342]

*Rationale: The intent of this requirement is to limit noise levels within the crew-habitable volume to allow for adequate voice communications and habitability during the onorbit mission operations. Limiting background noise, intermittent noise, narrow band SPL and providing audio volume control contributes towards enabling effective crew intercommunications. NC-52 limits noise levels within the crew-habitable volume to allow adequate voice communications and habitability during onorbit mission operations. The noise limit at 16 kHz does not appear in Figure 3.10.5.2-1, but is given in Table 3.10.5.2-1. In addition to the above background noise requirement, limiting intermittent noise, narrow band SPL and providing audio volume control also contribute towards enabling effective crew intercommunications.*



**Figure 3.10.5.2.1-1: NC Curves**

Note: Corresponding A-weighted SPLs and speech interference levels (SILs) are given for reference only (Beranek, L.L; Ver, I. L. (1992). Noise and Vibration Control Engineering, Principals and Applications, Chapter 17. John Wiley and Sons.) SIL (4) is Speech Interference Level, 4-band method.

**Table 3.10.5.2.1-1: Octave Band SPL Limits for Continuous Noise, dB re 20  $\mu$ Pa**

Octave Band Center Frequency (Hz)	63	125	250	500	1 k	2 k	4 k	8 k	16 k	NC
Work Areas	72	65	60	56	53	51	50	49	48	52

### 3.10.6 Radiation

#### 3.10.6.1 Ionizing Radiation

The radiation sources in space, Galactic Cosmic Radiation (GCR), trapped particle radiation, and Solar Particle Events (SPEs), have distinct physical and biological damage properties compared to terrestrial radiation, and thus require distinct methods to project and mitigate risks. In addition, all use of radioactive material (for example in auto-illumination or as a check source) or ionizing radiation-producing devices require adherence to established safety review and authorization procedures/constraints for NASA flight approval. Astronauts have been classified as radiation workers, and processes exist to protect them from excessive radiation exposure by keeping exposures As Low as Reasonably Achievable (ALARA).

#### 3.10.6.2 Radiation Design

##### 3.10.6.2.1 Radiation Protection

The CTS shall provide an assessment of protection from radiation exposure to ensure that effective dose (tissue averaged) to any crewmember is consistent with ALARA principles. [R.CTS.239]

*Rationale: The ALARA principle is a legal requirement intended to ensure astronaut safety. An important function of ALARA is to ensure that astronauts do not approach radiation limits and that such limits are not considered "tolerance values." ALARA is an iterative process of integrating radiation protection into the design process, ensuring optimization of the design to afford the most protection possible, within other constraints of the vehicle systems. The protection from radiation exposure is ALARA when the expenditure of further resources would be resource prohibitive by the reduction in exposure that would be achieved. The assessment should include exposure from the use of radioactive isotopes and radiation producing equipment onboard the spacecraft. Guidance on radiation design considerations and methods of assessment can be found in Section 4.8 of JSC 65995, Commercial Human System Integration Processes. When performing assessment, ISS design requirements for ionizing radiation protection can be found in Section 5.7.2.2.2 of SSP 50005 International Space Station Flight Crew Integration Standard to aid in evaluating the protection from radiation exposure.*

*Radiation protection for humans in space differs from that on Earth because of the distinct types of radiation, the small population of workers, and the remote location of astronauts during space flight. The definition of the worker population (NASA astronaut population) is*



*incorporated into the design limit. The radiation sources in space, GCRs, trapped particle radiation, and SPEs have distinct physical and biological damage properties compared to terrestrial radiation, and the spectrum and energy of concern for humans differs from that for electronics. Radiation protection for the crew must consider this environment and these concerns. Nominal mission exposure will be covered by a legal limit. See 10 CFR 20.1003 [Title 10 – Energy; Chapter I -- Nuclear Regulatory Commission; Part 20 -- Standards for Protection Against Radiation; Subpart A -- General Provisions]*

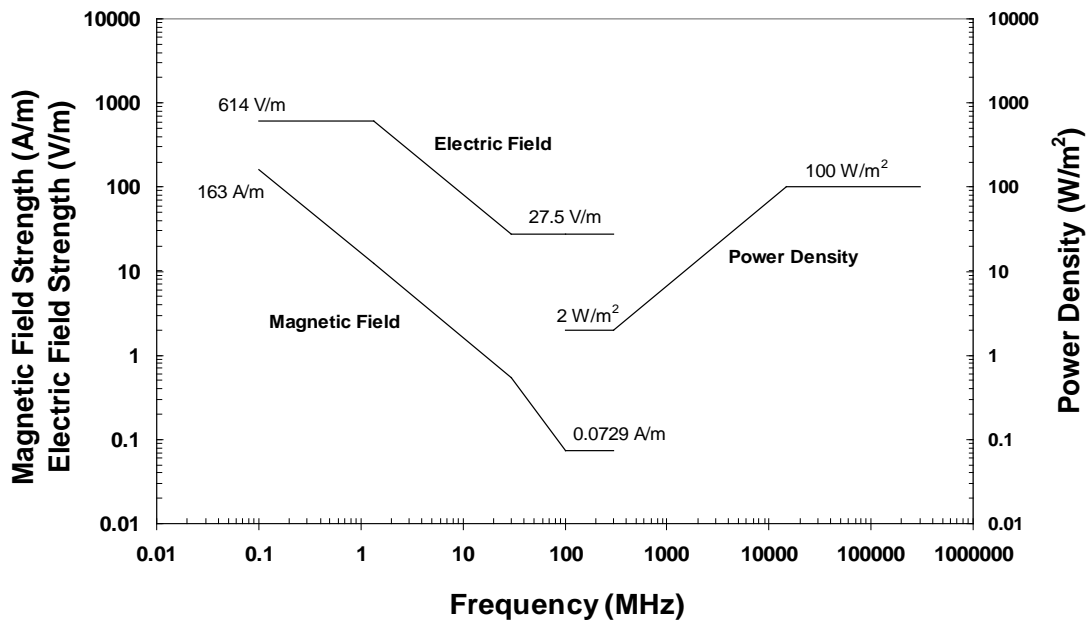
### **3.10.6.3 Non-Ionizing Radiation**

Sources of non-ionizing radiation are present in space flight applications, and exposure is potentially hazardous to crewmembers. Astronaut occupational exposure to non-ionizing radiation is managed through mission architecture, system design, procedures and planning, and application of appropriate countermeasures. This document classifies non-ionizing radiation into three categories: radio frequency (RF) radiation, lasers, and incoherent electromagnetic radiation.

#### **3.10.6.3.1 RF Non-Ionizing Radiation Exposure Limits**

The CTS shall protect the crew from exposure to RF radiation to the limits as shown graphically in Figure 3.10.6.3.1-1. [R.CTS.241]

*Rationale: These limits were modified from IEEE C95.1, Safety Levels with Respect to Human Exposure to Radio-Frequency Electromagnetic Fields, 3 kHz to 300 GHz, to remove an excessive factor of safety in the power density limit for general populations, including children. Design requirements cover exposure to RF radiation for the duration of a mission. Limits are intended to establish exposure conditions for RF and microwave radiation to which it is believed that nearly all workers can be repeatedly exposed without injury. Hazard analysis is necessary to identify potential sources of non-ionizing radiation exposure according to planned vehicle operations. Contributions of combined sources from the vehicle, hand-held devices, and other vehicles in proximity need to be considered. Exposure duration must also be considered. Exposure can be limited by eliminating or controlling RF sources, establishing appropriate keep-out zones, or controlling length of exposure.*



**Figure 3.10.6.3.1-1: RF Electromagnetic Field Exposure Limits**  
(Illustrated to show whole-body resonance affects around 100 MHz)  
(Modified from IEEE C95.1)

**Table 3.10.6.3.1-1: RF Electromagnetic Field Exposure Limits**  
(Modified from IEEE C95.1)

Frequency Range (MHz)	RMS Electric Field Strength (E) <sup>a</sup> (V/m)	RMS Magnetic Field Strength (H) <sup>a</sup> (A/m)	RMS Power Density (S) E-Field, H-Field (W/m <sup>2</sup> )	Averaging Time <sup>b</sup>  E  <sup>2</sup> ,  H  <sup>2</sup> , or S (min)	
0.1 – 1.34	614	16.3/f <sub>M</sub>	(1,000, 100,000/f <sub>M</sub> <sup>2</sup> ) <sup>c</sup>	6	6
1.34 - 3	823.8/f <sub>M</sub>	16.3/f <sub>M</sub>	(1,800/f <sub>M</sub> <sup>2</sup> , 100,000/f <sub>M</sub> <sup>2</sup> )	f <sub>M</sub> <sup>2</sup> /0.3	6
3 - 30	823.8/f <sub>M</sub>	16.3/f <sub>M</sub>	(1,800/f <sub>M</sub> <sup>2</sup> , 100,000/f <sub>M</sub> <sup>2</sup> )	30	6
30 - 100	27.5	158.3/f <sub>M</sub> <sup>1.668</sup>	(2, 9,400,000/f <sub>M</sub> <sup>3.336</sup> )	30	0.0636f <sub>M</sub> <sup>1.337</sup>
100 - 300	27.5	0.0729	2	30	30
300 - 5000	–	–	f/150	30	
5000 - 15000	–	–	f/150	150/f <sub>G</sub>	
15000 – 30,000	–	–	100	150/f <sub>G</sub>	
30,000 – 100,000	–	–	100	25.24/f <sub>G</sub> <sup>0.476</sup>	
100,000 – 300,000	–	–	100	5048/[(9f <sub>G</sub> -700)f <sub>G</sub> <sup>0.476</sup>	

*Note:  $f_M$  is the frequency in MHz;  $f_G$  is the frequency in GHz.*

*(a) For exposures that are uniform over the dimensions of the body, such as certain far-field plane-wave exposures, the exposure field strengths and power densities are compared with the MPEs in the table. For non-uniform exposures, the mean values of the exposure fields, as obtained by spatially averaging the squares of the field strengths or averaging the power densities over an area equivalent to the vertical cross section of the human body (projected area), or a smaller area depending on the frequency are compared with the MPEs in the table. For further details, see IEEE C95.1, notes to Table 8 and Table 9.*

*(b) The left column is the averaging time for  $|E|^2$ ; the right column is the averaging time for  $|H|^2$ . For frequencies greater than 400 MHz, the averaging time is for power density (S).*

*(c) These plane-wave equivalent power density values are commonly used as a convenient comparison with MPEs at higher frequencies and are displayed on some instruments in use.*

### **3.10.6.3.2 Laser Exposure Limits**

The CTS shall protect the crew from exposure to lasers in accordance with the limits in ANSI Z136.1-2007, American National Standard for Safe Use of Lasers for limiting skin and ocular exposure to both continuous wave and repetitively pulsed lasers without protective equipment. [R.CTS.242]

*Rationale: Contributions of combined sources from the vehicle, hand-held devices, and other vehicles in proximity need to be considered. Examples include docking lasers combined with the use of cameras on another vehicle. Design requirements are to cover exposure to both continuous and repetitively pulsed lasers to protect against skin and ocular injury. Tables 5a and 5b in ANSI Z136.1-2007, American National Standard for Safe Use of Lasers apply to ocular exposure and Table 7 applies to dermal exposure. This requirement applies to lasers used both internal and external to the spacecraft.*

### **3.10.6.4 Incoherent Electromagnetic Radiation**

#### **3.10.6.4.1 Retinal Thermal Injury from Visible and Near Infrared Source**

The spacecraft shall protect the crew from retinal thermal injury from visible and near infrared sources by limiting exposure to spectral radiance per Section I.1 in Appendix I. [R.CTS.244]

*Rationale: This requirement is intended to prevent retinal thermal injury from visible and near-infrared sources with wavelengths between 385 and 1,400 nm.*

#### **3.10.6.4.2 Visible Radiation Limits**

The spacecraft shall protect the crew from visible radiation sources by limiting the spectral radiance per Sections I.2 and I.3 in Appendix I. [R.CTS.245]

*Rationale: This requirement is intended to prevent retinal photochemical injury from exposure to visible-light sources with wavelengths between 305 and 700 nm. The sun is considered a small source since it subtends an angle of approximately 9 milliradians when observed from earth.*

### 3.10.6.4.3 Thermal Injury from Infrared Radiation

The spacecraft shall protect the crew from thermal injury from infrared radiation by limiting the spectral irradiance of the crew per Section I.4 in Appendix I. [R.CTS.246]

*Rationale: This requirement is intended to prevent ocular injury caused by overexposure to infrared radiation, including delayed effects to the lens (such as cataractogenesis.)*

### 3.10.6.4.4 Ultraviolet (UV) Exposure for Unprotected Eye or Skin

The spacecraft shall protect the crew from UV exposure for unprotected eyes and skin by limiting the spectral irradiance per Section I.5 in Appendix I. [R.CTS.247]

*Rationale: This requirement is intended to prevent ocular and dermal injury caused by overexposure to UV radiation. A table of weighted spectral irradiances versus permissible exposure times is given in Appendix I for discrete irradiances for reference.*

*Mitigation Rationale to Non Ionizing Radiation (NIR): Any exposure to NIR must consider the entire pathway of the incident radiation prior to its interaction with a crewmember's body, including any concentration, diffusion, or filtering. For example, concentration of source radiation by optical instruments and attenuation by vehicle window systems need to be considered when evaluating the final radiation incident upon the crewmember.*

*Protection from NIR may be accomplished through the reduction of effective irradiance or by limiting exposure times. Any means of providing NIR protection must not permanently degrade the ability of any optical systems including windows to perform their intended function. The transmittance required for windows, visors, and other optical devices can be reconciled with protection from NIR through the use of temporary filters, proper material selection, apertures, beam stops or splitters, or other appropriate means.*

### 3.10.7 RESERVED

### 3.10.8 RESERVED

### 3.10.9 RESERVED

### 3.10.10 Operational Limitations

This section provides requirements for operational limits that affect CTS architecture design. These operational constraints are considered during the design phase in order to develop an architecture that satisfies these operational requirements during actual missions.

#### 3.10.10.1 Crew Awake Period

The CTS shall require all nominal crew activities to occur during a crew-awake period of 16 hours or less on any free flight day except landing day, including:

- a. 1 hour post-sleep and 1 hour pre- sleep to transition between sleep and work activities.
- b. 30 continuous minutes per meal for consumption, with additional continuous time for meal preparation, for 3 meals a day.
- c. Crew sleep scheduled no earlier than 3 hours after launch.
- d. Any nominally planned docking or undocking/separation operations shall not begin prior to post-sleep and breakfast. [R.CTS.108]

*Rationale: A definition of a nominal crew awake period is required for planning and scheduling of the crew activities to meet mission objectives and to avoid crew fatigue and the resulting performance degradation. Free flight days include launch day and onorbit days where the spacecraft is not mated to the ISS for the full crew day. The total crew awake period is derived from existing requirements for NASA astronauts based on Apollo, Shuttle, and ISS experience. When meals, personal hygiene, and other time allocations are factored in, the effective time for mission related tasks is around 12 hours.*

*Time, referred to as pre and post-sleep, is to be allocated before crew sleep and after crew wake to allow the crew to transition between sleep and work related activities and to perform personal hygiene activities. The minimum time of one hour is based on the time required to transition between sleep and work related activities. Additional pre and post-sleep time above the one hour minimum may be required to accommodate hygiene activities for all crew depending on the number of crew and hygiene system. Pre and post-sleep timeframes do not include time for review/study in preparation for the day's activities, daily maintenance, payload science, or other spacecraft reconfiguration activities. The appropriate duration for maintenance and reconfiguration will depend on the vehicle design and the review/study time will be commensurate with the complexity and content of the day's activities.*

*The minimum time after crew wake before initiating complicated orbital operations, such as docking, allows time for hygiene and minimal meal activities and allows for acceptable cognitive performance before initiating complicated activities. Ideally 3 hours after crew wake is desired to ensure peak performance. On the day of launch (the crew day includes pre-launch activities), if the crew day duration onorbit is less than 3 hours, the crew may not be properly adjusted to the space environment when scheduled to sleep.*

*Meals will be allocated near the beginning, middle, and end of each day. The time required to prepare meals will depend on the design of the food system.*

### **3.10.10.2 Landing Day Crew Awake Period**

The CTS shall require all nominal crew activities to occur during a crew-awake period of 18 hours or less on landing day, inclusive of 6 hours post-egress for medical exam, hygiene/meal activities and baseline data collection for NASA sponsored crew.

- a. 1 hour post-sleep to transition between sleep and work activities.
- b. 30 continuous minutes per meal for consumption, with additional continuous time for meal preparation.
- c. Any nominally planned deorbit operations shall not begin prior to post-sleep and breakfast. [R.CTS.347]

*Rationale: Post-egress activities assume 1 hour for crew transportation and 5 hours for a combination of 4 hours of medical exam (baseline data collection) and 1 hour for hygiene/meal activities. The NASA Flight Surgeons will determine the suitability of any crewmember to participate in the post flight testing.*

### **3.10.10.3 Crew Sleep Period**

The CTS shall provide for a minimum of 8 continuous hours of crew sleep for all crew at the same time on any free flight day. [R.CTS.320]

*Rationale: To maintain circadian rhythm, a crewmember should be awake for 16 hours and sleep for 8 hours. If the sleep period is less than 8 hours, the crew will not receive enough rest. The sleep period for all crew must be scheduled at the same time since cabin size and configuration is not expected to be able to support sleep for a portion of the crew while other crewmembers are awake.*

#### **3.10.10.4 Crew Limits in Launch Orientation**

The CTS shall not allow any crew to be on their back with feet elevated in a launch configuration for longer than 5 hours, excluding subsequent safing and egress time. [R.CTS.348]

*Rationale: This position can be extremely fatiguing and cause musculoskeletal discomfort, which can affect cognitive performance and impairs crewmembers' ability to perform launch duties and emergency egress procedures. The time interval ends with liftoff.*

### **3.10.11 Internal Atmosphere**

#### **3.10.11.1 General**

##### **3.10.11.1.1 Habitability Limits**

The spacecraft shall maintain a habitable environment within the limits of Table 3.10.11.1.1-1 throughout all flight phases except during quiescent docked operations and post-landing. [R.CTS.346]

*Rationale: The spacecraft is to be designed to operate within the specified limits to ensure crew health and performance during the mission. Limits are derived from Space Flight Human Systems Standard, NASA-STD-3001, Volume 2: Human Factors, Habitability, and Environmental Health. This requirement is not applied during quiescent docked operations, as SSP 50808 requirements are applicable in that phase. This requirement does not apply in-total post-landing, as requirement 3.5.1.4, "Post-Landing Crew Services," is applicable in that phase.*

**Table 3.10.11.1.1-1: Atmospheric Habitability Limits**

Parameter	Nominal Minimum	Nominal Maximum	Rationale
a. Cabin Pressure	96.5 kPa (14.0 psia)	102.7 kPa (14.9 psia)	The intent of the requirement is for the spacecraft to be designed to operate nominally within the specified cabin pressure range to ensure crew health and performance during the mission. The spacecraft should be able to maintain the specified pressure around 101.35 kPa (14.7 psi) throughout all mission phases except quiescent docked operations. The crew cabin pressure of 101.3 kPa (14.7 psi), consisting mainly of an atmosphere of nitrogen and to a lesser extent oxygen, is a standard operating pressure for recently designed NASA spacecraft (Space Shuttle during non-EVA operations, SpaceLab, and ISS) to provide optimal cooling for air cooled avionics, payloads, and other equipment in addition to meeting crew life support needs.
b. Cabin ppO <sub>2</sub>	19.4 kPa (2.82 psia)	22.7 kPa (3.3 psia)	The spacecraft shall maintain oxygen partial pressure to the specified range throughout all mission phases except quiescent docked operations. The ranges/limits provided above are nominal physiological values for indefinite human exposure without measurable impairments to health or performance and is the range that ISS operates within. The nominal ppO <sub>2</sub> pressure for the Space Shuttle during non-EVA operations and SpaceLab is between 20.3 kPa (2.95 psi) and 23.7 kPa (3.45 psi) for a cabin pressure of 101.35 kPa (14.7 psi).
c. Cabin Depress/Repress Rates	No Minimum	Depress: 890 pa/sec (7.75 psi/min) Repress: 800 Pa/sec (6.96 psi/min)	These limits are driven by ISS cargo and are well within the physiological limits of the crew, however, it is expected that pressure changes will be effected more slowly than this where possible. The spacecraft shall limit exposure of the crew and cargo to the specified rate of change in order to prevent injury to the crew's ears and lungs and to avoid damage to cargo during depressurization and re-pressurization.

Parameter	Nominal Minimum	Nominal Maximum	Rationale
d. Cabin ppCO <sub>2</sub>	No Minimum	4.0 mmHg (0.077 psia)	The ranges/limits provided in this requirement are nominal physiological values for indefinite human exposure without measurable impairments to health or performance. Spacecraft CO <sub>2</sub> sensors may report values lower than the inhaled atmosphere, so precautions must be taken to ensure that local (relevant to crewmember's face) CO <sub>2</sub> does not exceed the limit.
e. Cabin Temperature	18.3 °C (65 °F)	26.7 °C (80 °F)	The temperature limits in this requirement protect for human comfort (and thus performance) without the use of thermal protective garments resulting in this narrow temperature range. The comfort zone is defined as the range of environmental conditions in which humans can achieve thermal comfort and not have their performance of routine activities affected by thermal stress. Thermal comfort is affected by the work rate, clothing, and state of acclimatization. If the crew is isolated from the cabin air due to wearing a pressure suit the cabin air temperature is then controlled by the air temperature requirement for the actively cooled payload requirement that can be found in SSP 50833.
f. Cabin Relative Humidity	25%	75%	The spacecraft must maintain average humidity above the lower limits stated to ensure that the environment is not too dry for the nominal functioning of mucous membranes. If humidity is not maintained above the lower limits, additional water must be provided to the crew to prevent dehydration. Humidity must be maintained below the upper limits for crew comfort, to allow for effective evaporation, and to limit the formation of condensation. Also, a humidity level below 25% relative humidity increases the risk of charge build up on equipment in the cabin and there is an increased electrostatic discharge (ESD) concern.



Parameter	Nominal Minimum	Nominal Maximum	Rationale
g. Cabin Velocities for Mixing (66% of bulk time-average velocity/minimum velocity)	4.6 m/min (15 ft/min) [bulk] 2.1 m/min (7 ft/min) [Min]	36.6 m/min (120 ft/min) [bulk] 60.9 m/min (200 ft/min)[Max]	<p>Crew and equipment give off heat, moisture, and CO<sub>2</sub> that will lead to parameters outside the bounds of environmental requirements if adequate ventilation is not provided. Maintaining proper ventilation within the internal atmosphere is necessary to ensure that stagnant pockets do not form, and the temperature, humidity, and atmospheric constituents are maintained within their appropriate ranges. Lower values to those in this requirement have been used on the Space Shuttle and ISS, but similar values are being proposed for Orion. See JSC 65993, Commercial Human-Systems Integration Requirements, CH6008 for rationale pertaining to values.</p> <p>Note: The measurements for this requirement exclude any area that is 15.2 cm (6 in) or less from the walls of the crew habitable cabin. It also excludes any area that is 7.6 cm (3 in) or less from avionics/secondary structure permanently in the crew habitable cabin, and seats.</p>

### 3.10.11.1.2 Cabin Pressure Maintenance during Leak

The spacecraft shall maintain the habitable pressurized volume at no less than 55.2 kPa (8.0 psia) for the time required to execute a deorbit and landing in the event of a cabin leak with an equivalent hole diameter of 0.64 cm (0.25 in).

- a. The life support system shall provide consumables for the entire crew during this time frame.
- b. The spacecraft deorbit entry and landing systems shall be fully operable down to a cabin pressure of 55.2 kPa (8.0 psi). [R.CTS.153]

*Rationale: This requirement defines the spacecraft response to a cabin leak or a structural breach in the cabin. The life support system must feed the leak for a discrete amount of time to allow the crew to execute a deorbit and landing. In this scenario, the spacecraft systems must be able to operate in a 55.2 kPa (8.0 psi) environment particularly from an avionics cooling perspective. The 0.64 cm (0.25 in) hole is derived from expected leak rates from lost seals on overboard hatches and feed-throughs based on previous human space flight experience for relatively small crew volumes.*

### 3.10.11.1.3 Return Contaminated Atmosphere within Limits

The spacecraft shall return the pressurized volume to a habitable environment as prescribed in Table 3.10.11.1.1-1 and meet the contamination limits prescribed in Table 3.10.11.1.3-1

following the contamination of the cabin atmosphere following a fire, or toxic chemical release when the hatch is closed. [R.CTS.152]

*Rationale: A contamination event due to a fire or toxic chemical release should not automatically cause long-term contingency operations that threaten crew health. Methods for cleaning the crew cabin include a cabin purge system to eliminate the contaminated atmosphere by venting the gas overboard and/or systems that are able to scrub the contaminants from the atmosphere through a filtration system.*

**Table 3.10.11.1.3-1: Post-Fire and Contamination Event Limits**

Contaminant	Limit
CO	200 ppm
HCN	5 ppm
HCl	5 ppm
All Other Contaminants	7-day SMAC values prescribed in JSC 20584 Spacecraft Maximum Allowable Concentrations (SMAC)

#### 3.10.11.1.4 Protect for Atmospheric Contingency

The spacecraft shall provide oxygen and nitrogen storage consumables sufficient to survive from the larger of two contingency scenarios:

- a. Purge and return to habitable environment following contamination of the cabin atmosphere per 3.10.11.1.3, or
- b. Feed a cabin leak per 3.10.11.1.2. [R.CTS.154]

*Rationale: Oxygen and nitrogen consumables must be allocated to respond to cabin pressure events. The contaminated atmosphere event includes consumables for emergency breathing for all crewmembers and a single cabin depress/repress if that is the method utilized to scrub the cabin atmosphere from contaminants. The unrecoverable cabin leak scenario includes consumables required to maintain cabin at 55 kPa (8 psia) until a deorbit burn can be executed and the vehicle reaches an altitude where the crew is able to survive utilizing the atmosphere exterior to the spacecraft. The consumables storage systems must be designed to protect for the largest amount of consumables of these two scenarios, but it is unreasonable to assume that both occur during the same mission.*

### 3.10.11.2 Detailed Pressurized Crew Cabin Requirements

#### 3.10.11.2.1 Crew Atmospheric Control

The system shall provide crew control of temperature and ventilation within the limits defined in 3.10.11.1.1 throughout all flight phases except during quiescent docked operations. [R.CTS.157]

*Rationale: The spacecraft is to provide the specified capability for crew control of habitable volume atmospheric parameters and set-points throughout all operations mission phases except quiescent docked operations. The ability to control local cabin ventilation by adjusting the direction of air flow enables the crew to prevent exhaled, CO<sub>2</sub>-rich air from building around the head and to prevent drying of facial mucous membranes. To provide crew capability to control atmospheric parameters, the vehicle must measure and display current parameters to the crew. Crew Control is also necessary to enable crew intervention in contingency scenarios specifically for crew overheating and mitigating the effects of Space Adaptation Syndrome.*

### **3.10.11.2.2 O<sub>2</sub> Limit**

The spacecraft shall limit oxygen concentration within the pressurized cabin to 24.1% by volume or less from a nominal cabin pressure per Table 3.10.11.1.1-1 to a cabin pressure of 70kPa (10.2psia). [R.CTS.166]

*Rationale: Spacecraft cabin and crew support materials are required to be compatible (non-fire-propagating) with 24.1% O<sub>2</sub> concentration based on the certification of the ISS.*

### **3.10.11.2.3 O<sub>2</sub> Limit during Depressurization**

The spacecraft shall maintain the oxygen levels in the cabin within the following range during a cabin depressurization event when the cabin pressure is between 70 and 55 kPa (10.2 and 8.0 psia):

- a. Greater than 17 kPa (2.4 psia) partial pressure of oxygen, and
- b. Less than 30% oxygen concentration. [R.CTS.167]

*Rationale: Spacecraft cabin and crew support materials are required to be compatible (non-fire propagating) at pressurized volume oxygen percentage up to 30% during a cabin depressurization based on the current data for the certification of the materials at reduced pressures for the Space Shuttle and the ISS Airlock. This is a hypoxic atmosphere and therefore will result in reduced crew performance and judgment to non-acclimatized individuals if the crewmember is breathing cabin air. Allowing a level of ppO<sub>2</sub> lower than Table 3.10.11.1.1-1 is acceptable since supplemental oxygen is available to the crew by mask and from the pressure suit.*

### **3.10.11.2.4 Accommodate Metabolic Loads**

The spacecraft shall accommodate crew metabolic loads provided in Appendix F - Metabolic Loads during all flight phases. [R.CTS.312]

*Rationale: Metabolic load data allows the Environmental Control and Life Support Systems (ECLSS) engineers to properly size the ECLSS system. Metabolic loads, in conjunction with the operational concept, provide an upper bound for oxygen (O<sub>2</sub>) demand, carbon dioxide (CO<sub>2</sub>) production, and heat rejection requirements. This information is vital for all spacecraft ECLSS designs. Appendix F provides a short description of the loads provided along with the assumptions used in the analysis. Guidance on the use of metabolic load data in the design process can be found in Section 4.11 of JSC 65995.*

### 3.10.12 Contamination

#### 3.10.12.1 Measure Toxic Combustion Products

The CTS shall report real time to the crew the concentration of toxic products to within the accuracies identified in Table 3.10.12.1-1 for carbon monoxide (CO), hydrogen cyanide (HCN), and hydrogen chloride (HCl). [R.CTS.182]

*Rationale: Because of the extreme danger from combustion in a spacecraft, real time combustion product monitoring and display are required to provide awareness to the crew in order that appropriate decisions can be made and actions taken to maintain health and safety (e.g., donning or doffing masks to provide contingency breathing capability). Real time monitoring is not restricted to continuous, vehicle-integrated monitoring, but must be readily available and activated quickly enough to provide operationally relevant data to facilitate informed decision making by the crew and ground-support staff in response to the hazard.*

**Table 3.10.12.1-1: Toxic Product Concentration Accuracies**

	Range (ppm)	Accuracy	
<b>CO</b>	5-500	For values from 50 to 500 ppm ± 10%	For values from 5 to 50 ppm ± 20%
<b>HCN</b>	1-50	For values from 20 to 50 ppm ± 20%	For values from 1 to 20 ppm ± 25%
<b>HCl</b>	1-50	For values from 20 to 50 ppm ±25%	For values from 1 to 20 ppm ±25%

#### 3.10.12.2 Use of Hazardous Chemicals

The CTS shall use chemicals that are Toxic Hazard Level 3 or below in the spacecraft habitable volume, as defined in JSC 26895, Guidelines for Assessing the Toxic Hazard of Spacecraft Chemicals and Test Materials. No compound that could decompose to a Toxicological Hazard Level 4 shall be used. [R.CTS.183]

*Rationale: Toxic hazard Level 4 compounds can pose an immediate risk to crew health and can cause permanent injury. They cannot be cleaned up by the crew and may not be scrubbed from the environment by the ECLSS system.*

#### 3.10.12.3 Gas Pollutant Limits

The spacecraft shall limit gaseous pollutant accumulation in the habitable atmosphere to below 1.0 T unit during all mission phases based on the length of crew exposure according to the individual chemical compound concentration limits established in JSC 20584, Spacecraft Maximum Allowable Concentrations for Airborne Contaminants.

- a. The spacecraft shall limit accumulation of pollutants in the habitable volume produced by metabolic loads and spacecraft system sources to 0.5 T units or less based on 7-day SMACs with the air revitalization system operating.

- b. The spacecraft shall limit accumulation of pollutants in the habitable volume produced by the load of equipment off-gassing to 0.5 T units or less based on 7-day SMACs with the air revitalization system operating. [R.CTS.184]

*Rationale: Airborne exposure limits for individual trace chemical contaminants and methods for assessing trace contaminant mixtures in a crewed cabin atmosphere are defined to protect crewmembers from illness and injury. The Spacecraft Maximum Allowable Concentrations (SMACs) provide guidance for short-term (1 and 24 hours), medium-term (7 and 30 days), and long-term (180 days and 1000 days) exposure of individual trace chemical contaminants. Short-term SMACs are designated as emergency SMACs and are intended to be used in emergency situations, such as accidental spills or fire. Medium and long-term SMACs are guidance levels intended to avoid adverse health effects, either immediate or delayed, and to avoid degradation in performance of crew after continuous exposure for the designated duration. The SMACs also take into account unique factors for human space flight including the stress on human physiology and uniform good health of astronauts and the absence of pregnant or very young individuals. The trace chemical contaminant load provided by Table 4.3.10.12.3-1 is a subset derived from JSC 20584, Spacecraft Maximum Allowable Concentrations for Airborne Contaminants, and SAE 2009-01-2592, A Design Basis for Spacecraft Cabin Trace Contaminant Control. The Table 4.3.10.12.3-1 load is used as the design basis until vehicle off-gassing test and vehicle system chemical release data become available at which time the equipment off-gassing and system generation data will supersede the Table 4.3.10.12.3-1 list. A toxic hazard, or T-unit, is a sum of the ratios of each predicted/measured pollutant concentration to the respective limit from JSC 20584.*

#### **3.10.12.4 Particulate Control**

The spacecraft shall limit the concentration in the cabin atmosphere of particulate matter ranging from 0.5 µm to 10 µm (respirable fraction) in aerodynamic diameter to <1 mg/m<sup>3</sup> and 10 µm to 100 µm to <3 mg/m<sup>3</sup>. [R.CTS.185]

*Rationale: Inhalation of particulates can cause irritation of the respiratory system. Limits for particulates are based on Occupational Safety and Health Administration (OSHA) standards for nuisance dusts, which is the best analog for the ordinary dust present in spacecraft. This does not include reactive dust (e.g., LiOH).*

#### **3.10.12.5 RESERVED**

#### **3.10.12.6 Microbial Limits**

The CTS shall limit the levels of microbial contaminants in the spacecraft habitable volume by maintaining an average continuous flow of 566.33 liters per minute (20 cubic feet per minute) or greater per person of air that has been cleaned to have at least 99.97% of airborne particles 0.3 µm and larger in diameter/size removed. [R.CTS.187]

*Rationale: Microbial limits for breathing air are designed to prevent infection and allergic response. Requirements are based upon industrial hygiene recommendations for similar environments (American Society of Heating, Refrigerating and Air-Conditioning Engineers (ASHRAE-62)). Limitations on fungi and bacteria in spacecraft are consistent with previous requirements, such as SSP 50260, Revision C, ISS Medical Operations Requirements Document (ISS MORD). ISS air systems utilize High Efficiency Particulate Air (HEPA) filter design to provide clean air. These filters have performed exceptionally well in controlling atmospheric microbial concentrations. This requirement does not apply to suited operations.*

### **3.10.12.7 RESERVED**

### **3.10.12.8 RESERVED**

### **3.10.12.9 Condensation Limits**

The CTS shall limit condensation persistence on interior surfaces to 1 hour per day within the spacecraft habitable volume throughout all flight phases except during quiescent docked operations. [R.CTS.190]

*Rationale: The system is to provide controls and mitigation steps to limit the formation of water condensate on internal surfaces, which has been demonstrated to promote growth of fungi, as this poses a hazard to crew health. These controls must consider pre-launch strategies until docking. Once docked to ISS, SSP 50808 sets condensation limits. Examples of moisture buildup from Mir and ISS missions that resulted in fungal growth include non-insulated cold surfaces and designed operations, which moisten surfaces (such as wetting a cloth) without appropriate drying. Condensation on a non-ventilated surface will be difficult to dry.*

### **3.10.12.10 RESERVED**

### **3.10.13 RESERVED**

### **3.10.14 Hatches and Doorways**

#### **3.10.14.1 Hatch Bi-directional Operability**

Ingress/egress hatches shall be operable from both the inside and outside the spacecraft by a single person during all flight phases when the hatch is used. [R.CTS.170]

*Rationale: In an emergency scenario, ingress/egress hatches should be simple enough to be operated by a single ground support team or flight crewmember. The hatch must also be opened and closed by a single crewmember from both inside and outside of the spacecraft.*

#### **3.10.14.2 Hatch Windows**

The CTS shall provide a window on all sealable hatches for direct non-electric visual observation of the environment on the opposite side of the hatch. [R.CTS.174]

*Rationale: Direct visual observation of the environment on the opposite side of a hatch allows the crew to determine the conditions or obstructions, such as the presence of fire or debris, on the other side of the hatch for safety purposes. Visibility is also needed for ground crew viewing into the vehicle during pad operations and post-landing. Windows do not have the failure modes associated with cameras and display systems that may not be operable during emergencies when most needed.*

### **3.10.15 RESERVED**

### **3.10.16 Crew Size, Mass, and Strength**

#### **3.10.16.1 Anthropometric Dimensions Standards**

The CTS shall accommodate NASA crew anthropometric dimensions provided in Appendix D, Table D-1 and Table D-2 and applicable suit conditions. [R.CTS.193]

*Rationale: The design of physical items that interface with the crew must account for crew anthropometry and applicable suit conditions using a human centered design approach as referenced in Section 3.1 of JSC 65995, CHSIP. This includes hand controls, seat*

*dimensions, hatch opening size, the distance from the seat to controls, handle dimensions, and other similar items. An analysis of expected crew operations, activities, and tasks along with the anthropometric dimension data contained in Appendix D often drive the design of human-machine interfaces. Guidance on the evaluation of the design using anthropometric data can be found in CHSIP, Section 4.5. The provided anthropometry data is representative of the NASA astronaut corps and based on the 2009 anthropometric selection criteria for astronaut applicants as documented in JSC 64548 Anthropometric and Strength Selection Criteria for Astronaut Applicants. The critical anthropometric dimensions represent measurements commonly deemed as most important to consider for vehicle and suit design based on past experience. For example, seated height is a critical dimension for seat design because it ensures head clearance, while biacromial breadth is critical to a proper design of restraint straps.*

### **3.10.16.2 Crew Body Mass Standards**

The CTS shall accommodate crew body mass provided in Appendix D, Table D-3.

- a. It is acceptable to utilize Appendix D, Table D-4 when computing the crew cabin mass of a complement of crewmembers rather than using the maximum weight for each crewmember.
- b. Appendix D, Table D-6 contains the center of mass for the human body.
- c. Body segment mass can be found in Appendix D, Table D-5. [R.CTS.194]

*Rationale: Body mass data is important for various systems. Most importantly, body mass properties must be used for propulsion calculations and ensuring the structural integrity of human system interfaces. Propulsion and system dynamic calculations depend on accurate data for the full range of crewmember mass to size the propulsion system and design proper vehicle dynamic controls. Vehicle systems with human system interfaces are to be designed such that they will not be damaged after being subjected to the forces that a crewmember can impart on that interface during acceleration. As an example, body support systems (e.g., seats, brackets, and restraints) must accommodate forces exerted by a crewmember, under all anticipated acceleration and gravity environments. Guidance on the evaluation of design using mass properties data can be found in Section 4.5 of JSC 65995, CHSIP.*

### **3.10.16.3 Crew Operation Loads**

Spacecraft hardware and equipment shall be operable with the lowest anticipated strength for tasks and flight configurations defined in Appendix E, "Minimum Crew Operation Loads." [R.CTS.195]

*Rationale: Hardware design should allow all crewmembers to perform any of the requested tasks efficiently and effectively, thus ensuring task and/or mission success. The data provided is for unsuited, suited-unpressurized, and suited-pressurized conditions. A human-centered design process is used when implementing operational strength limits, including analysis of expected crew operations, activities, and tasks that drive the design of human-machine interfaces. Guidance on the evaluation of design using crewmember strength data can be found in Section 4.5 of JSC 65995, CHSIP.*

### **3.10.16.4 Withstand Crew Loads**

Spacecraft components and equipment subjected to large forces by the crew shall withstand the forces as defined in Appendix E, Table E-1, "Crewmember Strength" ("Maximum Crew

Operation Loads" column) without sustaining damage for the pre-launch, ascent, orbit, and entry flight phases. [R.CTS.196]

*Rationale: Certain vehicle components and equipment are to be designed to withstand large forces exerted by a crewmember during nominal operation, without breaking or sustaining damage that would deem the hardware inoperable. Humans may exert high forces when operating controls in emergency situations, such as attempting to open a hatch for emergency egress. The resulting damage to equipment could make it impossible to respond safely to the emergency. To avoid overdesign, a task analysis is performed to identify which interfaces must tolerate maximum crew operational loads. This includes identifying critical hardware that may be inadvertently used as a mobility aid or restraint. Guidance on the evaluation of design using crewmember strength data can be found in Section 4.5 of JSC 65995, CHSIP; information on task analysis process can be found in Section 4.1. This requirement is applicable to intentional forces imparted on hardware by a crewmember.*

### **3.10.17 Crew Support Equipment**

#### **3.10.17.1 Trash Management**

The spacecraft shall provide a trash management system to contain, manage, and provide odor control for all trash, including biological waste and wet trash. [R.CTS.198]

*Rationale: The trash management system must contain all trash, with appropriate levels of containment and/or barriers, along with providing for odor control to avoid adverse effects on crew and crew performance. The trash management system is to be usable by crew and not allow inadvertent release of trash into the habitable volume during all mission phases. If not properly contained, trash contents could damage equipment, injure crewmembers, or transmit disease.*

*The development of the trash management system includes an analysis of expected crew operations, activities, and tasks that will generate trash, along with a characterization of expected trash (e.g., constitution, toxicity level, odor, volume, etc.). The trash containment design considers crew usability, types of trash, how and where trash will be stowed, and duration of stowage until disposal, environmental conditions, such as cabin depressurization event, and method of disposal. For odors, bags can provide some odor control, but the best practice for odor control has been through air circulation design. For example, air may be circulated from the crew cabin, then past the waste system and into ECLSS returns and charcoal filters or slowly bled over-board.*

#### **3.10.17.2 Sleep Accommodations**

The spacecraft shall provide accommodations and environment for crew sleep for all crewmembers. [R.CTS.199]

*Rationale: Proper sleep accommodations ensure that the crew is able to obtain adequate sleep/rest required for daily performance of tasks. Ideally, the system should provide a restrained position in accordance with the gravitational environment that allows for both full body extension, as well as for bringing both knees up to the chest. In order to develop an adequate sleep system, a human-centered design processes considers the following: 1) sufficient volume, 2) sleep surface area, including restraints for body positioning and blankets, 3) adjustable environmental conditions (e.g., lighting, noise), and 4) personal sleep items (e.g., clothing, bedding, and ear plugs).*



**3.10.17.3 RESERVED**

**3.10.17.4 Body Waste Management**

The spacecraft shall provide a body waste management system and supplies that provide for crewmember hygiene and collection, containment, isolation, stowage, odor control, and labeling for waste containers for volumes listed in Table 3.10.17.4-1. [R.CTS.203]

*Rationale: Body waste management facilities must be clean, efficient, and provide privacy for crew comfort, safety, and psychological health. In order to develop an adequate system for body waste management, human-centered design must consider the following: 1) supplies necessary to support all post-event hygiene needs and a location for proper stowage of supplies (for example wipes, towels, vomitus bags) that may be rapidly and readily accessed while crewmembers are restrained, 2) facility accommodations (e.g., restraints, full body visual privacy, auditory and olfactory privacy, private body self-inspection, and odor control from the system and trash), 3) facility functionality (that is, allowing simultaneous urination and defecation without completely removing lower clothing, splash control, and readily accessible means for collection and containment), 4) means for cleaning, sanitizing, and maintaining body waste management equipment and facilities, and 5) readily accessible means to eliminate and contain body waste management supply remains or floating particles (for example wipe containment and trash collection system, including feminine hygiene items). Additional guidelines regarding facility accommodations for feces, diarrhea, urine, and vomitus are contained in JSC 65993, CHSIR requirements CH7008, CH7009, and CH7011, respectively.*

**Table 3.10.17.4-1: Body Waste Management System Sizing Requirements**

Events	Quantity	Volume per Event	Max Rate per Event
Fecal matter per defecation	1.7 events/crewmember/day	118 mL avg	
Diarrhea	4 events/crewmember/mission	500 mL	
Urine	6 event/crewmember/day	333 mL avg	a) void rate of up to 50 mL/sec b) max output of 1 L during any given 1 hour period
Vomiting	8 events/crewmember/mission	500 mL	

**3.10.18 RESERVED**

**3.10.19 Water**

**3.10.19.1 Potable Water Physiochemical Limits**

The spacecraft shall provide potable water at or below the physiochemical limits defined in Appendix G, Table G-1 at all points of crew consumption or contact for drinking, food preparation, personal hygiene, and medical needs. [R.CTS.205]

*Rationale: Safe water pollutant levels have been established specifically for human rated space vehicles by the JSC Toxicology Group in cooperation with a subcommittee of the National Research Council Committee on Toxicology or are based on Maximum Contaminant Levels (MCL) established by the U.S. Environmental Protection Agency (EPA). Points of crew consumption or contact refers to the locations from which potable water is dispensed for use in drinks, food rehydration, personal hygiene, medical needs, and any potential in-flight maintenance sites.*

### 3.10.19.2 Potable Water Microbial Limits

The spacecraft shall provide potable water quality at or below the microbiological limits of Table 3.10.19.2-1 for crew consumption, food preparation, personal hygiene, and medical needs. [R.CTS.206]

*Rationale: Microbially safe water is essential to prevent infection and mitigate risk to crew health and performance. Points of crew consumption or contact refers to the locations from which potable water is dispensed for use in drinks, food rehydration, personal hygiene, medical needs, and any potential in-flight maintenance sites.*

**Table 3.10.19.2-1: Potable Water Microbiological Limits**

Characteristic	Maximum Allowable	Units
<b>Bacterial Count</b>	50	CFU/ml
<b>Coliform Bacteria</b>	Non-detectable per 100 ml	-
<b>Fungal Count</b>	Non-detectable per 100 ml	-
<b>Parasitic Protozoa, e.g., Giardia and Cryptosporidium</b>	0	-

Note: CFU = Colony Forming Unit.

### 3.10.19.3 Nominal Mission Water Provisions

The spacecraft shall provide potable water as follows:

- a. A minimum of 2.6 L (88 fl oz) of potable water for each crewmember per mission day for consumption and hygiene use.
- b. A minimum of 1.0 L (total) of potable water for eye irrigation and contingency use for medical treatment.
- c. At a temperature between 18 °C (64.4 °F) and 28 °C (82.4 °F) [R.CTS.207]

*Rationale: The amount of potable water required to maintain crewmember hydration status and allow crewmembers to perform duties nominally is 2.6 L (88 fl oz). Based on NASA's current food systems, intake breakdown consists of 2.6 L (88 fl oz) for drinking and hygiene water. The additional 1.0 L of water is reserved for eye irrigation and contingency use for medical treatment. The 1.0 L volume is for up to 4 crewmembers for all days of the mission to ISS. Eye irrigation is required for space flight based on experience and data from Shuttle, ISS, and Apollo programs. The water temperature range is required to prevent thermal injury to the tissues during irrigation. The quantity described in this requirement does not include potable water for other purposes such as sampling, pre-loading for reentry, and post-landing consumption, as represented in separate requirements.*

#### **3.10.19.4 Water Monitoring**

The spacecraft shall provide 3.5 L of potable water samples to support water quality monitoring from pre-launch check-out through post-landing recovery. [R.CTS.208]

*Rationale: Sufficient sampling water is needed to support ground-based analyses to ensure potable water quality. A quantity of 2.5 L (84.5 fl oz) of potable water is typical for pre-flight sampling and analysis to ensure the quality of the potable water loaded on the commercial vehicle for each launch. An additional 1.0 L (33.8 fl oz) is typically needed to support in-flight and post-flight sampling with ground-based analysis to confirm quality of the water consumed by the crew during each mission. A pre-flight potable water sampling and contamination assessment prevents in-flight water quality problems and thus minimizes the need for in-flight analysis of any potable water quality parameters. Ground-based quality analyses of in-flight and post-flight water samples provide a record of crew exposures and are used to determine follow-on ground processing steps. Ground crew or flight crew will collect the sample with NASA-provided sampling equipment carried in the environmental health kit, described in requirement 3.1.1.6, or provided to the ground crew. NASA or a NASA-approved laboratory will perform water quality analyses of the provided samples. If commercially available, pre-packaged water is provided as the source of potable water; water quantities for sampling may be reduced or waived upon NASA approval of the pre-packaged water quality and shelf-life. In order to facilitate this approval, a representative sampling strategy for this pre-packaged water would need to be developed.*

#### **3.10.19.5 Water for Fluid Loading**

The spacecraft shall provide each crewmember with a minimum of 1.4 L (48.0 fl oz) of fluid for each of two deorbit attempts for reentry fluid loading countermeasure. [R.CTS.210]

*Rationale: The fluid quantity is based on Space Shuttle aeromedical flight rule for Earth reentry fluid loading and includes quantity to support 3.4.2.4 Support Deorbit Delay. The fluid may be potable water to drink with 12 salt tablets (NASA-provided per Table 3.1.1.6-1) or alternative approved solution (e.g., consommé). For each fluid load, up to 0.5 L (16.9 fl oz) of potable water may be used from unconsumed daily water allocation per crewmember. Without this additional water allocation, the crew may have inadequate water available to fluid load and may become hemodynamically compromised during and after deorbit. Inadequate fluid loading will almost certainly cause physiological difficulties in some, if not most, crewmembers. Reduced blood and plasma volume can exacerbate orthostatic intolerance. Therefore, the requirement for fluid loading prior to re-entry, landing, and post-landing is tightly coupled with the requirements to provide protection against orthostatic intolerance (compression garments). Protection against orthostatic intolerance includes three major elements: lower body compression garments, fluid loading, and suit dissipation of metabolic heat loads.*

#### **3.10.19.6 Post-Landing Water**

The spacecraft shall provide immediate access to a minimum of 1.0 L (33.8 fl oz) of potable water per crewmember for each 8-hour period of the entire post-landing crew recovery period. [R.CTS.211]

*Rationale: Water is required during the entire post-landing phase, to ensure crewmembers are properly hydrated. This water needs to be available and accessible by the crew in their landing configuration (for example, seated and restrained) immediately upon landing. Less*

*water may be needed for hydration following a launch abort, since crewmembers will not have undergone space flight fluid loss. Each period up to 8 hours requires 1L of potable water per crewmember. It is acceptable to provide any additional water beyond the first 8 hours in the crew survival kit, since that water would only be necessary in the event of an abort or contingency landing.*

### **3.10.20 Crew Workspace/Stowage**

#### **3.10.20.1 RESERVED**

#### **3.10.20.2 Habitable Space Sizing**

The spacecraft shall provide sufficient work and habitable space, stowage, and physical accommodation in the defined use environments and for the defined tasks. [R.CTS.213]

*Rationale: To maintain a habitable volume and high level of mission performance and safety, it is important that architectural layout of the vehicle is functionally designed to provide defined locations and volumes that support expected crew activities, including mission operations, habitability functions, maintenance, and translation (e.g., movement between areas). Every effort should be made to separate functional areas for activities that could degrade or operationally conflict with each other, particularly emergency response activities, or that produce environmental conditions that are detrimental to mission performance or safety.*

*A human-centered design approach, as outlined in Section 3.1 of JSC 65995, will identify activities and/or tasks, especially those that are mission and safety critical, when designing functional layout. Mission and safety critical systems/hardware/components are to be identified using appropriate analysis methods. Guidance on design and evaluation of habitable volume can be found in Section 4.9 of JSC 65995, and information on evaluation of design using range of motion data can be found in Section 4.5, or in Appendix K of this document. Information on the crew task analysis process is in Section 4.1.*

## **3.11 Ground Support Equipment (GSE)**

### **3.11.1 Design of GSE**

The GSE shall be designed to prevent invalidation of the flight hardware certification.  
[R.CTS.314]

*Rationale: The intent of this requirement is to ensure that the design of the GSE does not impact the ability to achieve and maintain certification of the flight hardware due to the unique hazards associated with the GSE interfacing with the flight hardware or while operating the GSE within the proximity of flight hardware. See CCT-STD-1140, Section 6.0 for technical expectations pertinent to the engineering best practices for the design of GSE.*

## 4.0 Test and Verification

Verification requirements include the method(s) for verification (e.g., test and analysis), the purpose of the verification method(s), and the criteria for assessing the success of the verification method(s). Verification requirements take into account the specific design, relevant development and flight experience, and overall Commercial Provider plan for certification. Successfully implementing the methods defined in the verification requirements will enable the Commercial Provider to achieve certification by reducing the risk to a residual level acceptable by NASA. Final verification requirements must take into account the specific design, relevant development and flight experience, and overall Commercial Provider plan for certification.

### 4.1 General

Commercial Providers are responsible for verification planning and the performance of verification activities as specified in this document and in SSP 50808. The Commercial Providers will produce verification evidence for compliance with all applicable requirements.

Verifications are performed to evaluate the system relative to an attribute established by the requirement. The evaluations must ensure capabilities are evaluated within all the constraints established by CCT-REQ-1130, SSP 50808, applicable laws and regulations. Thus, test, analyses, and demonstrations must consider the full required operating envelope, environments, other visiting vehicles attached to the ISS, and range of states of the system when formulating the evaluation conditions.

The following definitions describe the methods that NASA would expect to use for verification of the requirements listed in Section 3.0, along with a brief description of each method. The test and verification methods described in the 4.3.X sections correspond to the 3.X requirement sections in the document.

#### **Inspection**

Engineering inspection, hereafter referred to as “inspection,” is a method of verification that determines conformance to requirements by the use of standard quality control methods to ensure compliance by review of drawings and data. This method is used wherever documents or data can be visually used to verify the physical characteristics of the product instead of the performance of the product.

#### **Analysis**

Analysis is a verification method utilizing techniques and tools such as math models, prior test data, simulations, analytical assessments, etc. The validation of the analysis with data acquired either by test or industry or government accepted standards, practices and methods is key to its credibility in critical decisions. Analysis may be used in lieu of, or in addition to, other methods to ensure compliance to specification requirements. The selected techniques may include, but not be limited to, task analysis, engineering analysis, statistics and qualitative analysis, computer and hardware simulations, and analog modeling. Analysis may be used when it can be determined that:

- a. Rigorous and accurate analysis is possible, and uncertainties and sensitivities are understood.
- b. Sufficient data exists, or can be made available, to validate the analysis.
- c. Verification by inspection is not adequate.

Examples of verification by analysis include thermal analysis and stress analysis to show that the use of the hardware does not exceed specification limits during the mission operation. Task analysis is used to verify that functional layout, reach, volume, workload, etc. support flight and ground crew activities.

### **Demonstration**

Demonstration consists of a qualitative determination of the properties of a test article. This qualitative determination is made through observation, with or without special test equipment or instrumentation, which verifies characteristics, such as human engineering features, services, access features, and transportability. Human-in-the-loop demonstration is performed for complex interfaces or operations that are difficult to verify through modeling analysis, such as physical accommodation for crew ingress and egress. Demonstration requirements are normally implemented within a test plan, operations plan, or test procedure.

### **Test**

Test is a method in which technical means, such as the use of special equipment, instrumentation, simulation techniques, and the application of established principles and procedures are used for the evaluation of components, subsystems, and systems to determine compliance with requirements. Test will be selected as the primary method when analytical techniques do not produce adequate results; failure modes exist which could compromise personnel safety, adversely affect flight systems or payload operation, or result in a loss of mission objectives. The analysis of data derived from tests is an integral part of the test program and should not be confused with analysis, as defined above. Tests will be used to determine quantitative compliance to requirements and produce quantitative results.

#### **4.1.1 Requirements Verification Approach**

The Commercial Provider's verification process will consist of, but not be limited to:

- a. Data for the reliability analysis collected and recorded during qualification.
- b. Engineering (development) evaluation and tests may be required for analyzing design approaches to ensure that requirements encompassing material selection, tolerances, and operational characteristics are satisfied. If development test data is intended to be used to qualify hardware, its intent will be previously declared.
- c. A qualification program encompassing the entire range of activity to verify that the design conforms to requirements when subjected to environmental life-cycle conditions, including those required for environmental workmanship screening during the acceptance phase. Flight fidelity qualification test articles will be used for the qualification program.
- d. Environmental models will be used to represent environments that cannot be achieved under the conditions of ground testing. Simulators, used for verifying requirements, will be validated such that the item undergoing qualification cannot distinguish between the simulator and actual operation hardware/software.
- e. Integration testing and checkout will be conducted during CTS hardware buildup. Activities, such as continuity checking and interface mating, will be performed. Activities, such as major component operation in the installed environment, support equipment compatibility, and documentation verification, will be proven during qualification.

- f. Qualification of CTS ground facilities will be performed in support of analyses, ground testing, and other verification activities. Qualification of facilities can be performed by comparison to real-world results or to another qualified facility.
- g. Formal verification of performance characteristics for the full range of performance requirements will be accomplished during qualification.

#### **4.1.2 Element Test Phase**

The basic objectives of ground tests will include, but not be limited to:

- a. Structural verification, including verification of stress and loads models and structural response (static, dynamic, acoustic, impact, and vibration tests).
- b. Validation of hardware layout modeling, installation, and assembly.
- c. Testing of life support systems.
- d. Thermal conditions of systems and structures, including those in a Flight Equivalent Unit (FEU) environment.
- e. Testing commercial crew communications systems, including RF blockage and multipath characterization.
- f. Firing tests (engine burns) and gas dynamics tasks.
- g. Testing and verification of the operability of the emergency rescue system (for COTS crew transport).
- h. Integrated electrical tests, including avionics tests.
- i. Integrated software tests, including testing in NASA Software Verification Facility.
- j. Integrated GN&C tests.

#### **4.2 Qualification and Acceptance Test Requirements**

The CTS qualification requirements are specified in section 3.9.13.1 of this document. Acceptance requirements of hardware for tests, as well as final flight units, are to be developed as part of the provider-developed CTS Certification Plan.



## **4.3 ISS Crew Transportation and Service Requirements**

### **4.3.1 ISS Destination Services**

#### **4.3.1.1 Top Level System**

##### **4.3.1.1.1 Launch Rate**

The ability of the CTS to perform two ISS missions in a year shall be verified by analysis. A statistical analysis shall determine the time required, in consideration of resources shared with other customers, to produce, transport, assemble, and test the flight systems and integrate them into mission configuration and prepare them for launch. The analysis shall also determine the time required to perform the requisite pre-mission planning, crew training, completion of the resolution plans of previous in-flight anomalies, and other required services. The analysis shall be in support of two, back-to-back, 180-day, missions beginning with mission requirements definition and ending with the nominal launch day. The verification shall be considered successful when the analysis shows the system and personnel preparation for launch can support two launches per year with a 95% probability and a 90% confidence. [V.CTS.001]

##### **4.3.1.1.2 Simultaneous Operation of Spacecraft**

The capability of the CTS to operate two spacecraft simultaneously shall be verified by inspection and analysis. The inspection shall review the procedures and staffing plans. An analysis of the capabilities of the CVCC(s), communications network, spacecraft and other ground-based systems shall be performed to determine if all mission requirements, for one docked spacecraft and one spacecraft operating in the free-flight mode or for both spacecraft docked, can be met. The verification shall be considered successful when inspection and analysis shows the flight and ground systems have the capability to simultaneously operate both spacecraft. [V.CTS.002]

##### **4.3.1.1.3 ISS Operations Impacts**

The requirement of the CTS to operate without impacting ISS operations due to real-time commanding, active monitoring, or maintenance during quiescent docked operations shall be verified by analysis. The analysis shall evaluate the provider's staffing plans, operations plans, operating procedures, and the CTS design. The verification shall be considered successful when the analysis shows the CTS can operate without impacting ISS operations due to real-time commanding, active monitoring, or maintenance during quiescent docked operations beyond the allowances specified in 3.8.3.1. [V.CTS.003]

##### **4.3.1.1.4 EVA Operations**

The ability of the CTS to perform all required mission functions and objectives without the use of EVA for nominal operations, contingency operations, or maintenance activity shall be verified by inspection. The inspection shall include a review of safety analysis and all planned and contingency operations. The verification shall be considered successful when completion of the inspection shows that there is no EVA required for nominal operations, contingency operations, or maintenance activity. [V.CTS.004]

##### **4.3.1.1.5 Provide Supplies**

The CTS's provision of equipment, supplies and consumables shall be verified by analysis and inspection. The analysis shall be performed to show that the supplies meet the required functions

and have sufficient quantity to meet the mission duration, including contingencies. The verification shall be considered successful when an inspection of drawings, hardware, and manifested equipment show that the spacecraft will be capable of carrying the necessary commodities for the crew. [V.CTS.005]

#### **4.3.1.1.6 Transport NASA-Provided Supplies**

The spacecraft's accommodation and utilization of NASA-provided supplies shall be verified by inspection and analysis. An inspection of drawings and equipment lists shall be performed to show the required stowage volume is available, supplies are accessible in the flight configuration and the required mass is allocated. An analysis shall be performed to determine the accessibility times required to meet mission operations and contingencies. The verification shall be considered successful when inspection of drawings shows the stowage masses and volumes are accommodated and the analysis shows the locations are accessible in the flight configuration in the time required for the operation the supplies support. [V.CTS.336]

#### **4.3.1.1.7 Supplies for Non-NASA Crew**

The CTS's provision of habitable consumables for non-NASA crew shall be verified by analysis and inspection. An analysis shall be performed to determine the habitable consumables required for the non-NASA crew during docked operations. A functional and performance analysis of consumable delivery shall be performed to show spacecraft resources are available to deliver consumables and delivery is within SSP 50808 constraints during docked operations. The verification shall be considered successful when an inspection done of drawings, hardware, and manifested equipment show that the spacecraft will be capable of carrying the necessary commodities for the non-NASA crew and the analysis shows spacecraft resources are available to transfer the required commodities. [V.CTS.006]

#### **4.3.1.1.8 NASA Crew**

The CTS's accommodation of 1, 2, 3, and 4 NASA crew during a single mission shall be verified by analysis and inspection. An analysis shall be performed to show the CTS can support the required crew size. An inspection of spacecraft drawings shall identify design accommodations for the maximum crew, cargo, and equipment. The verification shall be considered successful when the analysis and inspection show the CTS is capable of accommodating 1, 2, 3, and 4 NASA crew. [V.CTS.389]

### **4.3.1.2 Crew Transportation**

#### **4.3.1.2.1 Transport Crew**

The ability of the CTS to transport crew to the ISS shall be verified through test and analysis. The tests shall verify the required performance of the flight systems and may determine the statistical dispersions on their performance. Analysis shall include verified 3DOF and 6DOF simulations, including appropriate modeling of all systems affecting vehicle dynamics, along with their production variability and uncertainties for all appropriate flight phases. The trajectory simulations shall model the spacecraft's entire trajectory from launch through docking at the ISS for all required crew and cargo configurations. The analysis shall assume that the ISS does not perform translational maneuvers at any time to support rendezvous and, for this verification, is within the altitude band of 370km-460km. For the purposes of this verification, "docking" is defined as the planned first contact between the docking mechanisms. The simulation shall be considered successful for each case if the spacecraft docks to the ISS 24

hours after launch, when both the spacecraft and launch vehicle operate within verified capabilities, while observing defined limits for human capability, and while maintaining the expected factors of safety for vehicle thermal limits and structural load limits. This verification is intended to address nominal system operations and should not include flight or ground system failure scenarios or docking contingencies. The verification shall be considered successful when the Monte Carlo simulation(s) of the required transport scenarios, with natural environment and flight performance dispersions, achieves a 99.73% probability of success with at least 90% confidence throughout the transport mission profile. [V.CTS.010]

#### **4.3.1.2.2 Return Crew**

The ability of the CTS to return crew from the ISS shall be verified through test and analysis. The tests shall verify the required performance of the flight systems and may determine the statistical dispersions on their performance. Analysis shall include verified 3DOF and 6DOF simulations, including appropriate modeling of all systems affecting vehicle dynamics, along with their production variability and uncertainties for all appropriate flight phases. The trajectory simulations shall model the spacecraft's entire trajectory from un-docking within the ISS altitude band, as specified in SSP 50808 3.3.3.2.18, ISS Attitude and Orbit Constraints, through landing at each supported site for all required crew and cargo configurations. The simulation shall be considered successful for each case if the spacecraft successfully lands within the boundaries of a supported landing site, when the spacecraft operates within verified capabilities, while observing defined limits for human capability, and while maintaining the expected factors of safety for vehicle thermal limits and structural load limits. This verification is intended to address nominal system operations and should not include flight or ground system failure scenarios or deorbit contingencies. The verification shall be considered successful when the Monte Carlo simulation(s) of the required return scenarios, with natural environment and flight performance dispersions, achieves a 99.73% probability of success with at least 90% confidence throughout the return mission profile. [V.CTS.011]

#### **4.3.1.2.3 Docked Duration**

The requirement of the spacecraft to remain docked to the ISS for 210 days shall be verified by analysis. The analysis shall be performed for a full duration stay at each designated docking port and include the CTS spacecraft consumables quantities and margins maintained while docked, a crew timeline model for planned preventive maintenance based on component lifetimes and reliability, and data supporting component lifetime and reliability ratings. The verification shall be considered successful when the analysis shows the spacecraft has the consumables and functionality to support a crew return after a docked duration of 210 days. [V.CTS.012]

#### **4.3.1.2.4 Rotation Intervals**

The ability of the CTS to exchange up to 4 ISS NASA crew every 150 to 210 days shall be verified by analysis. A statistical analysis shall bound the time required to produce, transport, assemble, and test the flight systems and integrate them into mission configuration and prepare them for launch. The analysis will also bound the time required to perform the requisite pre-mission planning, crew training, completion of the resolutions plans of previous in-flight anomalies, and other required services. The analyses shall be in support of exchanging up to 4 NASA ISS crewmembers every 150 to 210 days beginning with mission requirements definition and ending with the nominal launch day. The verification shall be considered successful when the analysis shows the system and personnel preparation for launch can support exchanging up to

4 NASA ISS crewmembers every 150 to 210 days with a 95% probability and a 90% confidence. [V.CTS.013]

#### **4.3.1.2.5 Launch Sites**

The ability of the CTS to launch NASA crew from a U.S. (or U. S. State Department approved) launch site(s) shall be verified by inspection. The verification shall be considered successful when an inspection of the launch site shows it is a U.S. (or U. S. State Department approved) launch site(s). [V.CTS.014]

#### **4.3.1.2.6 Landing Sites**

The ability of the CTS to return NASA ISS crew to a designated primary landing site shall be verified by analysis and inspection. A functional analysis shall be performed to determine the ground system capabilities required at the landing site. The verification shall be considered successful when analysis of ground system capabilities and the inspection of drawings, equipment lists, and landing site features determine that ground system capabilities are available throughout the landing site. [V.CTS.015]

#### **4.3.1.3 Cargo Transportation**

##### **4.3.1.3.1 Accommodate Soft Stowage Cargo**

The spacecraft's accommodation of soft stowage cargo shall be verified by inspection. An inspection of cargo bays/stowage locations drawings shall be performed to show the volume allocated, with applicable dimensioning. An inspection of the spacecraft mass budgets shall be performed to show mass is allocated for cargo delivery and return. An inspection shall review verification closure of SSP 50833 Section 3.1.2, except for Triple CTB's in section 3.1.2.1 and all M-Bags in section 3.1.2.2. The verification shall be considered successful when the inspection confirms that the allocated volume and mass calculated is equal to or greater than the requirement and the cargo locations meet the applicable sections of SSP 50833. [V.CTS.016]

##### **4.3.1.3.2 RESERVED**

##### **4.3.1.3.3 Cargo in lieu of Crew**

The spacecraft's ability to accommodate an additional 100 kg of cargo in lieu of a NASA crewmember shall be verified by inspection. An inspection of spacecraft drawings shall be performed to show the volume allocated, with applicable dimensioning. An inspection of spacecraft mass budgets shall be performed to show mass is allocated for cargo delivery and return. An inspection shall review verification closure of SSP 50833 Section 3.1.2, except for Triple CTB's in section 3.1.2.1 and all M-Bags in section 3.1.2.2. The verification shall be considered successful when the inspection confirms that the volume and mass allocations are available to transport 100 kg of soft stowage cargo in lieu of a NASA crewmember and the cargo locations meet the applicable sections of SSP 50833. [V.CTS.020]

##### **4.3.1.3.4 Accommodate Hard Mounted Cargo**

The spacecraft's ability to accommodate hard mounted cargo shall be verified by inspection, test and analysis. An inspection of spacecraft drawings shall be performed to show the volume allocated, with the applicable dimensioning. An inspection of spacecraft mass budgets shall be performed to show mass is allocated for cargo delivery and return. An inspection shall review verification closure of SSP 50833 Sections 3.1.1 and 3.1.2, except for Triple CTB's in section 3.1.2.1 and all M-Bags in section 3.1.2.2. The analysis shall consist of thermal and power

assessments showing sufficient budgets for all flight phases. The test shall evaluate the ability to load two single powered middeck lockers or one double powered middeck locker using flight representative cargo and perform a mechanical, electrical and data interface test. The verification shall be considered successful when the inspection, test and analysis show the spacecraft is capable of accommodating each configuration of: two powered single middeck lockers, one powered double middeck locker, and equivalent soft stowage while meeting the applicable sections of SSP 50833. [V.CTS.021]

#### **4.3.1.3.5 Hard Mounted Cargo in lieu of Soft Stowage Cargo**

The spacecraft's ability to accommodate additional hard mounted cargo in lieu of the soft stowage cargo required by 3.1.3.1 shall be verified by inspection, test and analysis. An inspection of spacecraft drawings shall be performed to show the volume allocated, with applicable dimensioning. An inspection of spacecraft mass budgets shall be performed to show mass is allocated for cargo delivery and return. An inspection shall review verification closure of SSP 50833 Section 3.1.1. The analysis shall consist of a thermal and power assessments showing sufficient budgets for all flight phases, with at least 220W of power and 220W heat rejection for the sum of all powered cargo. The test shall evaluate the ability to load two single powered middeck lockers or one double powered middeck locker using flight representative cargo and perform a mechanical, electrical and data interface test. The verification shall be considered successful when the inspection, test and analysis show the spacecraft is capable of accommodating two additional powered single middeck lockers or one additional powered double middeck locker in lieu of the passive cargo specified in 3.1.3.1 and the cargo locations meet SSP 50833 Section 3.1.1. [V.CTS.383]

#### **4.3.1.3.6 Time-Critical Cargo Pre-Launch Handling**

The ability of the CTS to maintain cargo services per SSP 50833 and install soft stowage and hard mounted time-critical cargo within 24 hours of a launch shall be verified by demonstration and inspection. A demonstration shall be performed in the L-24 flight representative configuration and will evaluate the time to install and checkout time critical cargo within the allocated timeline. An inspection of the L-24 pre-launch timeline shall confirm an allocation for time critical cargo stowage activities. An inspection shall review verification closure of SSP 50833 Section 3.1.1. In addition, an inspection of spacecraft drawings shall verify access to all areas of the spacecraft available for storage of time critical cargo and the availability of these areas within the L-24 pre-launch timeline. The verification shall be considered successful when the demonstration and inspection show that the time to install and checkout time-critical cargo is equal to or less than the allotted time allowed by the pre-launch payload installation timeline in the L-24 window of opportunity and cargo services are maintained per SSP 50833, Section 3.1.1. [V.CTS.018]

#### **4.3.1.3.7 Time-Critical Cargo Removal**

The ability of the CTS to remove cargo from the pressurized volume no later than 1 hour after crew egress shall be verified by demonstration and inspection. The post-landing demonstration shall be performed with vehicle and cargo hardware in the landed-flight configuration and environment, post crew egress. The post-docking demonstration shall be performed with vehicle and cargo hardware in the flight configuration in a 1-g environment to ensure range of motion, clearance and fit. The verification shall be considered successful when the inspection shows processing timelines and environments for post-landing and post-docking scenarios are

commensurate with the demonstration results and provide for cargo removal within 1 hour after crew egress. [V.CTS.019]

#### **4.3.1.3.8 Docked Cargo Services**

The ability of the spacecraft to maintain cargo services shall be verified by inspection and analysis. For the purposes of this verification, it shall be assumed that the ISS will provide all necessary power and intermodule ventilation (IMV) to support spacecraft and cargo operations. The analysis shall evaluate the required ISS resources necessary to support spacecraft and cargo operations and evaluate the environmental conditions of the cargo. The analysis shall also ensure that the reliability of spacecraft systems necessary to support cargo operations is provided. An inspection shall review verification closure of SSP 50833, Section 3.1.1 for the available cargo services and environment. The verification shall be considered successful when the analysis and inspection show the spacecraft can maintain the spacecraft system reliability and cargo services per SSP 50833, Section 3.1.1. [V.CTS.394]

#### **4.3.1.4 Launch and Landing Probability/Availability**

##### **4.3.1.4.1 Launch Availability**

The CTS's launch probability, excluding external constraints and abort zone weather, of not less than 80% shall be verified by analysis. An analysis shall determine the probability of launch for launch opportunities when the ISS is within planar and phasing capabilities and within CTS weather constraints derived from the launch vehicle and spacecraft operating limits and integrated launch loads analysis throughout the dispersed trajectory. Historical monthly weather data shall be used in these assessments. A system availability analysis shall determine the probability of launch including reliability of ground systems, CVCC, spacecraft and launch vehicle systems throughout launch operations in the induced and natural environments from tanking until launch window close. The verification shall be considered successful when the analysis determines the combined probability of launch within CTS weather constraint and system availability is not less than 80% with a 90% confidence. [V.CTS.022]

##### **4.3.1.4.2 Launch Recycle Time**

The CTS's ability to provide launch opportunities for two consecutive days, beginning with the initial launch attempt, shall be verified by analysis. The analysis shall assess pad, launch vehicle, spacecraft, and CVCC launch re-cycle timelines including a task by task review of activity durations commodity availability and capacity; operations and logistics plans; and the time and resources required to perform launch tasks on consecutive calendar days. The verification shall be considered successful when the analysis results show that the CTS architecture can provide launch opportunities for two consecutive calendar days. [V.CTS.023]

##### **4.3.1.4.3 Launch Lighting**

The ability of the CTS to launch independent of all ambient lighting conditions shall be verified by analysis. The analysis shall include a review of CTS systems required to enable launch under any lighting conditions and can show that the flight systems, facility systems, and GSE will operate independent of all ambient lighting conditions for launch. Systems to be considered are tracking (optics and radar), recovery/rescue aids, imagery (ground and flight based), GSE, and facilities. The verification shall be considered successful when the analyses show that the flight and ground systems are capable to support launch of the integrated space vehicle independent of all ambient lighting conditions. [V.CTS.024]

#### **4.3.1.4.4 Landing Lighting**

The ability of the CTS to land independent of all ambient lighting conditions shall be verified by analysis. The analysis shall include a review of CTS systems, required to enable landing during any lighting conditions and can show that the flight systems, facility systems, and GSE will operate independent of all ambient lighting conditions for landing. Systems to be considered include tracking (optics and radar), navigational landing aids, recovery/rescue aids, imagery (ground and flight based), GSE, and facilities. The verification shall be considered successful when the analyses show that the flight and ground systems are capable to support landing of the CTS independent of all ambient lighting conditions. [V.CTS.025]

#### **4.3.1.5 Onorbit**

##### **4.3.1.5.1 RPOD Lighting**

The spacecraft's ability to perform rendezvous, proximity operations, docking, and undocking independent of lighting and ground site overflight constraints shall be verified by inspection and analysis. An inspection shall be performed on the CTS constraints (such as GNC, communications, sensors, thermal control) to determine the effects of ambient lighting and ground site location on spacecraft operations for rendezvous, proximity operations, docking and undocking. The analysis shall show that the dispersed nominal and planned contingency trajectories and timeline are uninhibited by lighting and ground site overflight constraints. Only a possible exception for minor approach adjustments during brief periods of degraded navigation/crew visibility will be allowed. The analysis shall encompass all possible lighting conditions including the complete range of solar and lunar beta angles. The verification shall be considered successful when, for all US docking ports, the inspection and analysis shows that ground overflight and ambient lighting constraints used in the trajectory design, including selection of planned docking and undocking times, allow docking and undocking to occur within 95% of the planned orbit.

See CCT-STD-1140, "Flight Mechanics and GN&C Technical Assessment" section for technical verification expectations pertinent to flight mechanics. [V.CTS.026]

##### **4.3.1.5.2 Relocate to Different Docking Port**

The spacecraft's ability to perform one relocation between docking ports after the initial docking shall be verified by analysis. Statistical analysis shall determine the vehicle state (position and attitude) dispersions and system performance required to accomplish the relocation. For the purposes of this verification, "docking" is defined as the planned first contact between the docking mechanisms. The verification shall be considered successful when the analysis shows at least 99.73% with 90% confidence of the cases dock within the docking contact conditions. [V.CTS.027]

##### **4.3.1.5.3 ISS Fly-around**

The spacecraft's ability to perform one complete fly-around after undocking at a range of less than 250 meters, as measured from spacecraft center of mass to ISS center of mass, shall be verified by analysis. A statistical analysis shall determine the vehicle state (position and attitude) dispersions and system performance required to accomplish the fly-around. The verification shall be considered successful when the analysis shows at least 95% with 90% confidence of the cases result in a 360 degree planar transit around the ISS. [V.CTS.028]

#### **4.3.1.5.4 Support Photography during Fly-Around**

The spacecraft's provision for crew photography shall be verified by test, analysis and inspection. The test shall characterize the optical properties of the crew photography window(s). Visual uniformity inspections shall be done on the finished windows; otherwise, any other inspections may be done on witness samples. The analysis shall evaluate the spacecraft fly-around trajectory and the photography window orientation. The verification shall be considered successful when the analysis shows that the crew photographer can take pictures without impeding the piloting tasks and the test shows the windows' optical properties meet or exceed category D of JSC 66320 and the visual uniformity inspections show that there are no readily identifiable non-uniformities in any of the individual panes and in the finished window stack. [V.CTS.384]

### **4.3.2 Safety and Mission Assurance**

#### **4.3.2.1 Crew Safety**

##### **4.3.2.1.1 Loss of Crew Risk**

The CTS shall verify the Loss of Crew (LOC) requirement for all nominal mission phases and contingency operations:

- a. **Mission:** The mean LOC risk for any ISS mission shall be verified through a Probabilistic Safety Analysis (PSA). The PSA methodology shall be defined utilizing the methodology described in CCT-PLN-1120 as a guide. The mission LOC shall include LOC faults initiated by the CTS from the beginning of crew ingress, prior to launch, through crew egress during recovery. The LOC analysis shall exclude operational controls from the ISS performed while approaching, departing and docked to ISS, such as TPS inspections. The LOC analysis shall include Contingency Spacecraft Crew Support (See Appendix B) for CTS initiated faults which preclude the capability for entry. Since crew rescue mission plans have not been finalized, crew rescue mission effectiveness shall be defined as a uniform distribution between 97% and 99% multiplied by the probability of a successful CTS reentry for the purpose of LOC calculations. The verification shall be considered successful when the analysis shows the calculated mean value of LOC for the 210 day mission is no greater than 1 in 200.
- b. **Ascent/Entry:** The mean LOC risk for any ISS mission combined ascent and entry phase shall be verified through a PSA. The PSA methodology shall be defined utilizing the methodology described in CCT-PLN-1120 as a guide. The mean LOC risk shall be calculated for ascent and entry separately, but for the purposes of requirement verification, ascent and entry shall be combined. Ascent LOC analysis shall include all ascent LOC faults initiated from the beginning of crew ingress, prior to launch, through orbital insertion and entry LOC includes all entry LOC faults initiated from deorbit burn ignition through crew egress during recovery. The verification shall be considered successful when the analysis shows the calculated mean value of LOC for the combined ascent and entry phase is no greater than 1 in 500. [V.CTS.030]

##### **4.3.2.1.2 Loss of Mission Risk**

The CTS Loss of Mission (LOM) for an ISS mission shall be verified by a PSA. The PSA methodology shall be defined utilizing the methodology described in CCT-PLN-1120 as a guide. LOM is defined in Appendix B. LOM analysis shall include faults initiated by the CTS which lead to an ascent abort or termination of the mission earlier than the pre-launch planned EOM



timeframe, contingency spacecraft crew support (see Appendix B), inability to dock with the ISS, and LOC. Loss of low priority mission objectives, such as cargo, inability to perform fly-around, ISS port relocation, or minor mission delays are not considered a LOM. Verification shall be successful when the analysis shows the calculated mean value of LOM for the entire 210 day mission is no greater than 1 in 55. [V.CTS.031]

#### **4.3.2.1.3 Flight Element Stability**

The stability and control requirement shall be verified through analysis. Analysis shall include verified 6DOF simulations, including appropriate modeling of all systems affecting vehicle dynamics, along with their uncertainties, as well as stability analysis for all appropriate flight phases. The verification shall be considered successful when the analysis shows a 99.73% probability, with 90% confidence, that the vehicle will be controllable and that there is stability with established margin. See CCT-STD-1140 section 5.4.2, "Flight Mechanics and GN&C Technical Assessment" for technical verification expectations pertinent to flight mechanics. [V.CTS.317]

#### **4.3.2.2 Safety and Hazard Control**

##### **4.3.2.2.1 Monitor Controls and Inhibits**

The CTS monitoring of the status of controls and inhibits shall be verified by analysis. A hazard analysis shall identify controls and inhibits whose inadvertent activation or failure to activate leads to a catastrophic event. A functional and performance analysis shall define the functions, limits, and scales of each monitoring capability. The verification shall be considered successful when the analysis of each monitoring capability indicates the operational status of the control or inhibit can be ascertained by the system or crew. [V.CTS.033]

##### **4.3.2.2.2 Control Critical Hazards**

Control of critical hazards shall be verified by hazard analysis. The provider methodology, process, and plans for conducting the hazard analysis shall be consistent with CCT-PLN-1120. The verification shall be considered successful when the hazard analysis shows that all identified critical hazards are controlled and the hazard controls are verified. [V.CTS.341]

#### **4.3.2.3 Failure Tolerance**

##### **4.3.2.3.1 Failure Tolerance to Catastrophic Events**

Failure tolerance for catastrophic hazards shall be verified by analysis. An integrated hazard analysis shall be performed to identify all potential hazard causes and controls and show compliance with the required level of failure tolerance. The provider methodology, process, and plans for conducting the hazard analysis shall be consistent with CCT-PLN-1120. The verification shall be considered successful when the analysis shows that all identified catastrophic hazards that are mitigated by failure tolerance are controlled and verified. [V.CTS.034]

##### **4.3.2.3.2 Failure Tolerance without Aborts**

The CTS's ability to not rely on pad or ascent aborts, or emergency systems to meet failure tolerance requirements shall be verified by inspection. The verification shall be considered successful when review of the failure tolerance verification analysis (Paragraph 4.3.2.3.1) ensures that failure tolerance is not met through reliance on the proper operation of pad or ascent aborts, or an emergency system. [V.CTS.035]

#### **4.3.2.3.3 Separation of Redundant Systems**

The CTS separation of redundant systems should be verified by analysis. The hazard analysis should examine redundant systems for potential common cause events. The verification will be considered successful when the analysis ensures the physical separation or protection of the systems is present. [V.CTS.339]

#### **4.3.2.3.4 Isolate and Recover from Faults**

The CTS's ability to perform fault isolation and recovery of functions, the absence of which would result in a catastrophic event, shall be verified by analysis and demonstration. Safety analysis shall identify the faults for which the system shall isolate and recover. The verification shall be considered successful when the critical faults identified by the safety analysis have been confirmed by demonstration to be isolated and the associated redundant function is activated in time to prevent the catastrophic event. [V.CTS.038]

#### **4.3.2.3.5 Failure Tolerance without Corrective Maintenance**

The CTS's ability to not rely on maintenance to meet failure tolerance requirements shall be verified by inspection. The verification shall be considered successful when review of the failure tolerance verification analysis (Paragraph 4.3.2.3.1) ensures that failure tolerance is not met through corrective maintenance. [V.CTS.125]

#### **4.3.2.4 Health and Status**

##### **4.3.2.4.1 Detect and Annunciate Faults**

The CTS's detection and annunciation of critical faults shall be verified by analysis and test. Safety analysis shall identify all critical faults the system shall detect and annunciate. The test shall be performed by simulating the critical faults using flight software and flight representative hardware. The verification shall be considered successful when the critical faults identified by the safety analysis have been confirmed by test to be detected and annunciated. [V.CTS.037]

##### **4.3.2.4.2 Record and Display Health and Status**

The CTS's recording, transmission, and display of health, status, and engineering data shall be verified by analysis and test. The analysis shall identify the required health, status, and engineering data sets needed and the timeliness required for the intended use in nominal operations, anomaly resolution, catastrophic event reconstruction, and commit to flight decision making. The verification shall be considered successful when the test confirms the required sets of generated health, status, and engineering data are recorded, displayed to the crew, and received at the CVCC in a time consistent for the purposes they are intended, in support of nominal operations, flight anomaly resolution, catastrophic event reconstruction, and commit to flight decision making. [V.CTS.040]

##### **4.3.2.4.3 Flight Imagery**

The CTS's capture, recording, transmission, and time synchronization of imagery data shall be verified by analysis and demonstration. The analysis shall identify the required field of view, resolution, frequency of images, etc. needed for performance assessment, anomaly resolution, and mishap event reconstruction. The verification shall be considered successful when the demonstration confirms the required systems are functional and provide the imagery needed for performance assessment, flight anomaly resolution, and mishap event reconstruction. [V.CTS.072]

#### **4.3.2.4.4 Monitor Environments**

The ability of the CTS for capturing data of the direct and indirect effects of natural and induced environments shall be verified by analysis and inspection. The analysis shall determine the natural and induced environments that could exceed certification limits prior to launch. The verification shall be considered successful when the inspection shows that systems are employed to capture data associated with environmental and operational events that could result in exceedances to the integrated space vehicle design limits during production, handling, transportation, assembly/integration/testing, pre-launch processing, launch operations phases, and post-landing (if flight hardware is planned to be reused). [V.CTS.074]

#### **4.3.2.4.5 Natural Environments**

The establishment and utilization of identified natural environments to the CTS shall be verified by inspection. Natural environment related risks, mitigation methods, and related design margins shall be identified and controlled in accordance with the criteria in the "Natural Environments" section of CCT-STD-1140. The inspection shall review verification closure of allocations of the identified natural environments to design elements. The verification shall be considered successful when the inspection shows that the identified natural environments have been utilized in the evaluation of CTS design elements. [V.CTS.382]

#### **4.3.2.5 Emergency Equipment**

##### **4.3.2.5.1 Access Emergency Equipment**

The access of CTS emergency equipment within a time commensurate with the applicable emergency shall be verified by analysis and demonstration. The analysis shall identify and determine time to respond to emergency situations. The demonstration shall show that a crewmember can access emergency equipment and position it for use in a flight representative vehicle in flight configuration. The verification shall be considered successful when the analysis and demonstration confirm that emergency equipment can be accessed for response to emergency situations without the use of tools and within the time required to respond to the hazard. [V.CTS.041]

##### **4.3.2.5.2 Breathing Mask**

The spacecraft's ability to supply a contingency breathing apparatus whenever the cabin atmosphere may be contaminated and whenever an unplanned reduction in cabin pressure occurs shall be verified by inspection and analysis. An inspection shall be performed that shows an adequate number of contingency breathing apparatuses are stored on the spacecraft to support all crewmembers onboard the spacecraft at all times and identifies the stowage location. The inspection must also show that the apparatus protects each crewmember's eyes and respiratory system during an emergency event. An analysis shall be performed to show that the contingency breathing apparatus can fit the varying size of any crewmember onboard the spacecraft. Another analysis shall be performed to show that the contingency breathing apparatus provides a safe individual breathing supply to all crewmembers simultaneously for the duration needed whenever the cabin atmosphere may be contaminated and whenever an unplanned reduction in cabin pressure occurs. The verification shall be considered successful when inspection and analysis show that the contingency breathing apparatus provides each crewmember a safe individual breathing mask to provide protection and breathable atmosphere until CO, HCN, and HCl levels have been re-established per table 3.10.11.1.3-1 in case of contamination event and

until crew are in a fully functioning pressure suit in case of an unplanned reduction in cabin pressure. [V.CTS.042]

#### **4.3.2.5.3 Voice Communication in Breathing Apparatus**

The CTS's capability for crew to communicate with other crewmembers and with the CVCC while wearing contingency breathing apparatus shall be verified by demonstration. The demonstration shall be performed with personnel using flight-representative contingency breathing apparatus and include communication between individuals and with the CVCC and spacecraft. The demonstration shall be performed under expected ambient noise levels. The verification shall be considered successful when the demonstration shows that voice communications exist between crewmembers and with the CVCC while wearing the contingency breathing apparatus under expected ambient noise levels. [V.CTS.043]

#### **4.3.2.5.4 Emergency Lighting**

The CTS's emergency lighting shall be verified by analysis, test and demonstration. A task analysis shall determine the operations required for operational recovery and crew egress, and task surfaces required to support those operations. The test shall evaluate task surfaces required for operational recovery and emergency crew egress paths in a flight representative vehicle in the flight configuration. The test shall perform illumination measurements made on and normal to the task surface(s) with a subject positioned to perform the operational tasks, including egress. The test shall evaluate automatic activation of emergency lighting by interrupting primary vehicle power and measuring elapsed time to activation of emergency lighting. For unpowered emergency illumination sources, a demonstration shall be performed with the spacecraft emergency egress configuration. The verification shall be considered successful when test shows that emergency lighting can be automatically activated and illumination levels support operational recovery activities and the demonstration shows that unpowered emergency illumination sources support crew egress. [V.CTS.044]

#### **4.3.2.5.5 Portable Fire Suppression**

The spacecraft's portable fire suppression system shall be verified by inspection, analysis, and demonstration. An analysis shall be performed to identify the types and locations of potential ignition sources, suppression methods and suppressant for each, and location of access ports for portable fire extinguishers. The inspection of drawings and models shall confirm accessibility of portable fire suppression in their stowed locations, that any enclosed volume that needs fire suppression has a portable fire extinguisher access port to allow fire suppressant to be dispensed in it without having to open an access door/panel, that the portable fire extinguisher has adequate clearance to interface with the portable fire extinguisher access port, and that the portable fire extinguisher has a visual device to verify adequate quantity of fire suppressant in it. Manual operation and accessibility of the portable fire suppression system shall be verified by demonstration in a flight-representative configuration. The verification shall be considered successful when the inspection, analysis, and demonstration shows that portable fire suppression equipment is provided in location(s) accessible to crew within 1 minute in the event of emergency. [V.CTS.045]

#### **4.3.2.5.6 Personal Protective Equipment**

The spacecraft's provision for PPE, including automated PPE, shall be verified through analysis and inspection. An analysis shall be performed to identify potential emergency scenarios and

their designed control measures that include crew PPE. There will be an inspection of PPE stowage locations. The verification shall be considered successful when the analysis and inspection show that PPE is provided for each crewmember and is accessible by crew for potential emergency events. [V.CTS.046]

#### **4.3.2.5.7 Fire Detection and Suppression in Isolated Areas**

The spacecraft's fire event detection and fire suppression for the enclosed/isolated areas in the pressurized volume shall be verified by analysis, inspection and demonstration. An analysis shall be performed to identify the types and locations of potential ignition sources, suppression methods and suppressant for each, and placement of detection and suppression equipment. The analysis shall show that the spacecraft detects events indicating impending fire and limits propagation of the event in the enclosed/isolated areas in the pressurized volume, and that enclosed/isolated areas that the crew cannot reach with a portable fire extinguisher have a fixed fire suppression system. An inspection of drawings shall be performed to verify that fire event detection, and fixed fire suppression hardware are placed in the enclosed/isolated areas in the pressurized volume where there is forced air flow and potential ignition sources or credible oxygen enrichment/leakage and potential ignition sources. The inspection shall also show that the fixed fire suppression hardware provides a means to determine that adequate quantity of fire suppressant is available for use by the crew and ground at all times. A demonstration of a simulated smoke alarm and vehicle response shall show that a fire event in the enclosed volume in the pressurized volume can be detected and suppressed. The verification shall be considered successful when the analysis, inspection, and demonstration show that a fire in the enclosed/isolated areas in the pressurized volume can be detected and suppressed before it can propagate. [V.CTS.047]

#### **4.3.2.5.8 Locate Spacecraft after Landing**

The ability of the CTS to provide spacecraft location to the recovery/rescue forces after landing shall be verified by analysis. The analysis shall be performed to show the spacecraft is capable of providing location data in a hatch closed configuration for the landed spacecraft to the recovery/rescue forces. The analysis should be able to show that the range of the capability is appropriate and consistent with the recovery/rescue force deployment strategy. The verification shall be considered successful when the analysis shows the spacecraft is capable of providing recovery/rescue forces with its location in a hatch-closed configuration from landing until the recovery/rescue forces arrive at its location. [V.CTS.089]

#### **4.3.2.5.9 Fire Detection in Habitable Cabin**

The spacecraft's cabin fire event detection shall be verified by analysis, inspection and demonstration. An analysis shall be performed to identify the types and locations of potential ignition sources and the type and placement of detection equipment. An inspection of drawings shall be performed to verify that the detection hardware has been installed in the crew habitable cabin. A demonstration of a simulated fire shall show that a fire event in the cabin can be detected. The verification shall be considered successful when the analysis, inspection and demonstration show that a fire event in the habitable cabin can be detected. [V.CTS.349]

#### **4.3.2.5.10 Protection from Cabin Depressurization**

The CTS's ability to protect each individual crewmember from a depressurized cabin during ascent and entry shall be verified by test. All of the following suit tests shall be performed with a

flight representative suit. A test shall be performed to show the suit operates at a minimum pressure of 3.5 psia while in a reduced pressure cabin. The test shall be performed with a flight representative O<sub>2</sub> supply system to show that the suit system provides nominal 100% O<sub>2</sub> when operated in a depressurized cabin. In addition, tests shall be performed to show that the suit limits ppCO<sub>2</sub> to less than 5 mm Hg around the face area without violating the cabin nominal oxygen concentration limits. The test shall be performed at representative operational metabolic rates as shown in Appendix F and at ambient cabin conditions for nominal ascent and entry operations to show that the suit limits ppCO<sub>2</sub> to less than 5 mm Hg around the face area without violating the cabin nominal oxygen concentration limits. The test shall also be performed to show that the suit limits ppCO<sub>2</sub> to less than 5 mm Hg around the face area when operated during reduced cabin pressure. A test of the spacecraft shall be performed to show that the spacecraft can provide the necessary resources to the suits to support keeping the ppCO<sub>2</sub> levels in the face area of the space suit to less than 5 mmHg and provide oxygen to the space suits in a depressurized cabin. The verification shall be considered successful when the suit and spacecraft tests confirm that the suit operates at a minimum pressure of 3.5 psia, provides nominal 100% O<sub>2</sub> when operated in a depressurized cabin, limits ppCO<sub>2</sub> to less than 5 mm Hg around the face area in a depressurized cabin, and limits ppCO<sub>2</sub> to less than 5 mm Hg around the face area in a nominal cabin environment. [V.CTS.048]

#### **4.3.2.5.11 Pressure Suits**

##### **4.3.2.5.11.1 Suited Habitable Duration**

The ability of the CTS to provide a sufficient quantity of consumables to sustain life of the pressure-suited crew in a depressurized cabin shall be verified by analysis. An analysis shall be performed to determine the worst case duration to execute a deorbit, entry, and landing of the vehicle. An analysis shall be performed to determine the worst case duration to execute an ascent abort at any point along the trajectory. These analyses shall assume no additional CTS failures after the depressurization event. The verification shall be considered successful when the analysis confirms the CTS provides a sufficient quantity of consumables to sustain life of the pressure suited crew for the longest duration of the two scenarios assessed in the duration analyses. [V.CTS.322]

##### **4.3.2.5.11.2 Donning during Leak**

The ability of the suit to provide for unassisted donning and connection to life support shall be verified by analysis and demonstration. A task analysis shall be performed to identify all tasks required by the crew to complete suit donning and connection to life support without assistance. A demonstration shall be performed by a test subject in 1-g using a flight representative suit. The verification shall be considered successful when the test subject performs all tasks required in the task analysis and successfully dons the suit and connects to life support without assistance. [V.CTS.324]

##### **4.3.2.5.11.3 Suit Communications**

The ability of the suit to provide two-way voice communications between crewmembers and crewmembers to the CVCC shall be verified by demonstration. The demonstration shall consist of suited test subjects in flight representative suits performing voice checks. The verification shall be considered successful when the demonstration shows that the suit provides two-way voice communication between the test subjects and between the test subjects and the CVCC. [V.CTS.328]

#### **4.3.2.5.11.4 Body Waste Management in Suit**

The suit's ability to contain urine and feces shall be verified by inspection. The inspection shall consist of a review of suit drawings and flight equipment list. The verification of suit body waste management shall be successful when the inspection of suit drawings shows a body waste collection system or diapers are included on the flight equipment list. [V.CTS.332]

#### **4.3.2.5.11.5 Suit Accommodation of Metabolic Loads**

The suit regulation of the crew core body temperature under metabolic loads shall be verified by analysis. The analysis shall identify the tasks, flight configurations, and associated metabolic rates of each crewmember. The analysis shall evaluate atmospheric ppO<sub>2</sub>, ppCO<sub>2</sub>, temperature, and relative humidity for all suited phases. The analysis shall evaluate the crew core body temperature of suited crewmembers in all flight phases. For contingency scenarios, the thermal control system can be assumed to be functional. The verification shall be considered successful when the analysis shows that the suit is capable of accommodating the expected metabolic loads imposed by the crewmember, per Appendix F, "Metabolic Loads," by maintaining the required suited conditions of 3.2.5.10 and crew core body temperatures between 97 °F and 100.5 °F. [V.CTS.388]

#### **4.3.2.5.12 Unassisted Vehicle Egress**

The CTS's provision of unassisted vehicle egress during the pre-launch and post-landing timeframe shall be verified by demonstration and analysis. A demonstration of unassisted egress shall be performed in a flight-representative vehicle with a full crew complement in their flight configuration for pre-launch and post-landing. The demonstration shall begin with the decision to egress and exercises all procedures required for egress, such as equalizing pressure across and opening the hatch, releasing all restraints, and translating all crew through the hatchway onto surfaces representative of both pre-launch and post-landing environments. A demonstration of the deployment of the launch pad-to-spacecraft interface system shall be performed to establish the time to the first crewmember egress. The verification shall be considered successful when the analysis of the demonstration results confirms that all the crewmembers can egress the vehicle in 90 seconds from the decision to egress. [V.CTS.087]

### **4.3.2.6 Software**

#### **4.3.2.6.1 Manually Override Software**

The integrated space vehicle manual override capability for the automation system shall be verified by analysis and demonstration. A functional allocation analysis will identify the automated tasks to be performed by the flight software. Hazard analyses will identify which automated tasks can be overridden without directly causing a catastrophic event. The demonstration shall be performed using flight-configuration software and a list of automated tasks. The demonstration shall involve engaging the automated system and having a human operator manually override each automated task identified in the functional allocation analysis. The verification shall be considered successful when the demonstration shows that all identified automated tasks can be manually overridden by a human operator. [V.CTS.050]

#### **4.3.2.6.2 Manually Override Software - Post-Separation**

The spacecraft's manual override capability for the automation system shall be verified by analysis and demonstration. A functional allocation analysis will identify the automated tasks to

be performed by the flight software. Hazard analyses will identify which automated tasks can be overridden without directly causing a catastrophic event. The demonstration shall be performed using flight-configuration software and a list of automated tasks. The demonstration shall involve engaging the automated system and having a human operator manually override each automated task identified in the functional allocation analysis. The verification shall be considered successful when the demonstration shows that all identified automated tasks can be manually overridden by a human operator. [V.CTS.370]

#### **4.3.2.6.3 Autonomous Operation of System**

The autonomous operation of system and subsystem functions shall be verified by analysis and test. A functional analysis shall determine the critical functions for integrated space vehicle operation. The test shall confirm that the critical functions defined by the functional analysis can be regulated without input from the CVCC. The verification shall be considered successful when the analysis and test shows critical functions require no inputs from the ground for nominal or contingency operations. [V.CTS.051]

### **4.3.3 Pre-Launch/Ascent**

#### **4.3.3.1 Pad and Ascent Aborts**

##### **4.3.3.1.1 Detect and Initiate Abort**

The detection and automatic initiation of an abort shall be verified by analysis and test. Safety analysis shall be used to identify the failure modes for which the monitoring system will be required to detect and initiate an abort to meet LOC requirements. The analysis shall identify detection and confirmation methods including the maximum detection latency times for each failure. The test shall be conducted using flight representative hardware and flight software for the launch vehicle, spacecraft, abort systems, and interfaces to ground systems. The test shall include worst case latency during pad and ascent flight phases and exercise all abort triggers. The tests shall determine the performance of the detection system and abort initiation logic. The verification shall be considered successful when the analysis shows, for identified failure modes, the space vehicle is able to detect the need for an abort with sufficient time for the crew to depart prior to catastrophic failure. [V.CTS.057]

##### **4.3.3.1.2 Determine Abort Mode**

The automatic selection of abort modes by the spacecraft shall be verified by analysis. The analysis shall be performed using primary flight software. The analysis shall include the conditions throughout the ascent flight phase and for different types of ascent aborts. The analysis shall include both nominal and off-nominal ascent trajectories to the ISS. The verification shall be considered successful when the analysis shows that the probability is at least 99.865% with 90% confidence that the spacecraft automatically selects the correct abort mode for the conditions. [V.CTS.056]

##### **4.3.3.1.3 Pad Abort**

The CTS's pad abort capability requirement shall be verified through test and analysis. The tests shall determine the performance of the abort logic and abort flight systems. Analysis shall include verified 6DOF simulations, including appropriate modeling of all systems affecting pad abort dynamics, along with their uncertainties. The Monte Carlo will simulate the spacecraft's entire abort trajectory from abort initiation through landing location. The abort capability shall



be considered successful for each analysis if the aborting spacecraft demonstrates controllability, no near-field re-contact with the launch vehicle or ground infrastructure, operation within hardware thermal constraints, human capability constraints, structural loads limits, and ability to achieve acceptable landing. The verification shall be successful when a Monte Carlo simulation of the required abort scenario with environmental and spacecraft dispersions achieve a 95% probability of success with at least 90% confidence. This does not cover assessment of catastrophic conditions assessed by the LOC analysis in requirement 3.2.1.1. [V.CTS.055]

#### **4.3.3.1.4 Ascent Abort**

The continuous launch abort capability requirement shall be verified through test and analysis. Safety Analysis establishes the failure initiators and the time period(s) during ascent for which they are credible. The tests shall determine the performance of the detection system, abort logic, and abort flight systems. Analysis shall include verified 6DOF simulations, including appropriate modeling of all systems affecting vehicle and launch abort dynamics, along with their uncertainties for all appropriate flight phases. The Monte Carlo will insert the launch vehicle failures in a random fashion, uniformly through-time, throughout the ascent trajectory. Note – failure initiators can be selected assuming a uniform probability distribution during the time periods for which they are credible or based on documented probabilistic analysis. The Monte Carlo will simulate the spacecraft's entire abort trajectory from abort initiation through landing location or achievement of a stable orbit (for abort-to-orbit cases). This includes vehicle rotation rates during launch vehicle loss of control and changes in acceleration due to launch vehicle loss of thrust. The abort capability shall be considered successful for each analysis if the aborting spacecraft demonstrates controllability, no near-field re-contact with the launch vehicle, increasing spacecraft inertial velocity during abort motor burns that initiate during transonic (max spacecraft drag) and high dynamic pressure conditions, operation within: hardware thermal constraints, human capability constraints, structural loads limits, and ability to achieve acceptable landing. The verification shall be successful when a Monte Carlo simulation of the required abort scenarios with environment, launch vehicle, and spacecraft dispersions, in time bins no larger than 10s each, achieves a 95% probability of success with at least 90% confidence for each time bin throughout the ascent profile. This does not cover assessment of catastrophic conditions assessed by the LOC analysis in requirement 3.2.1.1.

See CCT-STD-1140, "Flight Mechanics and GN&C Technical Assessment" section for technical verification expectations pertinent to flight mechanics. [V.CTS.058]

#### **4.3.3.1.5 Ascent Abort Reliability**

The abort system reliability shall be verified by analysis. The verification shall be considered successful when the calculated hardware and software reliability of the abort system from the abort subsystem initiation command until abort systems operations are no longer active exceeds 0.995. [V.CTS.059]

#### **4.3.3.1.6 RESERVED**

#### **4.3.3.1.7 Aborts outside DAEZ**

The ability of the CTS to provide ascent aborts that result in landing outside the DAEZ shall be verified by analysis. The verification shall be considered successful when the abort analysis, in support of verification 4.3.3.1.4, shows that the spacecraft is capable of landing outside the DAEZ for all abort initiation times. [V.CTS.061]

#### **4.3.3.1.8 Abort without Launch Vehicle Thrust**

The CTS's performance of a pad and ascent abort that separates the spacecraft from the launch vehicle without relying on thrust from the launch vehicle shall be verified by analysis. The verification shall be considered successful when the abort analyses, in support of verifications 4.3.3.1.3 and 4.3.3.1.4, show that separation is achieved without relying on launch vehicle thrust for all pad and ascent abort conditions. [V.CTS.062]

#### **4.3.3.1.9 Abort on Flight Termination System Command**

The abort on FTS command with adequate time delay shall be verified by analysis and test. The analysis shall evaluate all system latencies associated with the abort (communication latency, abort system thrust ramp-up, etc.). Relative motion and debris analysis of an FTS initiated-abort with time delay shall be performed to verify re-contact and debris strike risks are minimized commensurate with the Loss of Crew Risk Requirement 3.2.1.1. Tests shall be performed using flight representative hardware and flight software under simulated flight conditions for defined destruct criteria/scenarios negotiated with the range. The verification shall be considered successful when the crewed space vehicle automatically initiates the ascent abort sequence on receipt of an FTS command with automatic abort system, both enabled and manually inhibited. [V.CTS.063]

#### **4.3.3.1.10 Initiate Pad and Ascent Abort**

The capability of the crew and the CVCC to initiate the pad and ascent abort sequence shall be verified by test. For each possible abort mode, during pad operations and ascent, the test shall confirm the commanded abort sequence from both the crew interface and ground interface. Verification that downlink data and uplink abort commands are successfully transmitted is confirmed by closure of requirements 3.7.1 and 3.8.1.2. The verification shall be considered successful when the response to the abort command is initiation of the appropriate abort sequence for the given trajectory and vehicle performance conditions. [V.CTS.064]

### **4.3.3.2 Emergency Pad Egress**

#### **4.3.3.2.1 Detect Emergency Pad Egress**

The ability of the CTS to detect and alert the CVCC of conditions requiring an emergency pad egress shall be verified by test and analysis. Safety analysis shall identify the conditions the CTS shall detect and alert the CVCC of those hazards that require an emergency pad egress. The test shall be performed for each unique detection system by simulating the conditions requiring an emergency pad egress using flight representative software and hardware in a flight configuration. The verification shall be considered successful when the test shows all conditions identified in the safety analysis can be detected by each detection system and those detection systems have the ability to alert the CVCC of conditions requiring emergency pad egress. [V.CTS.065]

#### **4.3.3.2.2 Ground and Flight Crew Emergency Pad Egress**

The ability of the CTS to provide for ground and flight crew emergency egress during hazardous pre-launch activities shall be verified by demonstration and analysis. The hazard analysis shall determine the time to effect for each emergency egress scenario throughout the countdown and the effectiveness of the designated safe location and pre-coordinated collection point. These emergency egress scenarios start from the completion of crew egress at the spacecraft hatch interface and end with the securing of the last individual at the pre-coordinated collection point

outside the blast danger area. Each segment of an emergency egress scenario shall be demonstrated in the flight configuration with emergency systems active. The verification shall be considered successful when the analysis and demonstration of the operational system shows that ground and flight crew egress can be achieved in the response times as determined by the hazard analysis for each scenario. [V.CTS.066]

### **4.3.3.3 Range Safety**

#### **4.3.3.3.1 Alert Crew of Flight Termination**

The integrated space vehicle's ability to alert the crew upon receipt of arm and destruct FTS command shall be verified by demonstration. The demonstration shall be performed with flight software and flight representative hardware and an emulated FTS command. The verification shall be considered successful when the demonstration shows the crew has been alerted to the receipt of an arm and destruct FTS command. [V.CTS.069]

#### **4.3.3.3.2 Range Safety Program Compliance**

The CTS's compliance with NPR 8715.5A Range Flight Safety Program shall be verified by inspection and analysis. The analysis shall identify all design and operational constraints imposed by NPR 8715.5A and their allocation to CTS design and production elements. The verification shall be considered successful when the inspection shows that allocated CTS design and production elements have met NPR 8715.5A. [V.CTS.350]

### **4.3.3.4 Launch Support System**

#### **4.3.3.4.1 Protection from Lightning**

The ability of the CTS to prevent direct attachment of lightning channels to the integrated space vehicle while on the ground shall be verified by analysis. The verification shall be considered successful when the analysis of the operational plans and lightning protection system design shows that the integrated space vehicle is protected from direct lightning attachment while on the ground with 95% or greater probability of success with 90% confidence. [V.CTS.073]

#### **4.3.3.4.2 Accommodate NASA Personnel at CVCC**

The ability of the CTS to provide CVCC accommodations for mission essential NASA personnel shall be verified by inspection. The inspection shall include a review of CTS systems, including facilities, communications (voice loops, telephones, etc.), CVCC console displays, network access, and telemetry to show that the NASA designated consoles support the real-time monitoring and ability to communicate with NASA personnel in ISS MCC-H. The verification shall be considered successful when an inspection shows the CVCC accommodations for 4 mission-essential NASA personnel are in place. [V.CTS.071]

### **4.3.4 Onorbit**

#### **4.3.4.1 Contingency**

##### **4.3.4.1.1 Emergency Return from ISS**

The CTS's provision for emergency return within 24 hours shall be verified by analysis and inspection. Analysis shall assume nominal spacecraft systems function and nominal consumables when the emergency event occurs. Analysis shall be performed to evaluate spacecraft power-up timelines, crew ingress into the spacecraft, hatch closure, and departure timelines. The analysis shall vary ISS altitudes per SSP 50808 3.3.3.2.18, ISS Attitude and Orbit

Constraints, and departure times through a 1 month timeframe. An inspection shall review the process to choose emergency landing sites during any 24 hour period that minimizes the time from the emergency return decision until crew rescue and transport to a definitive medical care facility. This process shall also account for notification of agencies involved in the landing operations and subsequent rescue. The verification shall be considered successful when the analysis and inspection shows that the CTS can accomplish the mission planning, spacecraft ingress, departure operations, landing site selection, notification of agencies involved in the landing and rescue, and subsequent landing from any point in the ISS-mated portion of the mission within 24 hours.

See CCT-STD-1140, "Flight Mechanics and GN&C Technical Assessment" section for technical verification expectations pertinent to flight mechanics. [V.CTS.106]

#### **4.3.4.1.2 Undock without ISS Services**

The ability of the spacecraft to perform undocking and separation operations without services from the ISS shall be verified by analysis. Analysis in the form of modeling and simulation, as well as review of operational procedures and functions, shall be performed to verify that the CTS mission profile and spacecraft are capable of all undocking and separation without aid from the ISS. The verification shall be considered successful when the analysis shows that the spacecraft has the system performance necessary to perform undocking and separation operations without any supporting services from the ISS vehicle. [V.CTS.076]

#### **4.3.4.1.3 Autonomous Deorbit**

The spacecraft's capability to autonomously target and perform a deorbit, entry, and landing, starting with orbit insertion, shall be verified by test and analysis. A safety analysis is utilized to determine the failure scenarios that require an emergency return, along with the time required from the initiation of the failure to landing, in order to provide for the safe return of the crew. An operational analysis shall be performed to determine the tasks required to deorbit, enter, and land to a supported landing site. A functional analysis shall be performed to determine the system performance necessary to perform the autonomous targeting and execute the deorbit, entry, and landing. A test shall be performed using flight software and flight representative hardware to evaluate the system performance and capability to autonomously target landing opportunities. The verification shall be considered successful when the analysis and test show the spacecraft has the capability to autonomously target, deorbit, enter, and land at provider-designated landing sites. [V.CTS.086]

#### **4.3.4.2 Spacecraft Operations and Durations**

##### **4.3.4.2.1 Docking 24 hours after Launch**

The CTS's ability to dock 24 hours after launch shall be verified by analysis. For the purposes of this verification, "docking" is defined as the planned first contact between the docking mechanisms. The verification shall be considered successful when the analysis in support of verification 4.3.1.2.1 shows that the CTS spacecraft docks to ISS within the docking contact conditions 24 hours +/- 1 hour after launch and when the rendezvous phase window is at least 190 degrees. [V.CTS.078]

#### **4.3.4.2.2 Multiple Approach Attempts**

The spacecraft's ability to perform an additional approach and docking attempt 90 minutes after the initial attempt from an operationally-safe standoff distance shall be verified by analysis. A statistical analysis shall determine the vehicle state (position and attitude) dispersions, system performance, and consumables required to accomplish the additional attempt. For the purposes of this verification, "docking" is defined as the planned first contact between the docking mechanisms. The verification shall be considered successful when the analysis shows at least 99.73% with 90% confidence of the cases dock within the docking contact conditions on the second attempt at least 90 minutes after the initial attempt. [V.CTS.079]

#### **4.3.4.2.3 Support Docking Delay**

The spacecraft's ability to dock 24 hours after the initial docking attempt shall be verified by analysis. A statistical analysis shall determine the vehicle state (position and attitude) dispersions, system performance, and consumables required to accomplish the 24 hour delay. For the purposes of this verification, "docking" is defined as the planned first contact between the docking mechanisms. The verification shall be considered successful when the analysis shows at least 99.73% with 90% confidence of the cases dock within the docking contact conditions. [V.CTS.080]

#### **4.3.4.2.4 Support Deorbit Delay**

The spacecraft's capability to allow for a minimum of 24 hours delay past the nominal deorbit burn shall be verified by analysis. Analysis in the form of modeling and simulation shall be performed to verify that the CTS mission profile and spacecraft shall have sufficient consumables and other resources to allow (at all times during the mission) for a 24 hour delay following a deorbit waive-off. Verification shall be considered successful when the analysis shows that the spacecraft capability and the performance of the planned mission profile allow for a minimum of a 24 hour delay and still maintain the capability to deorbit after that timeframe. [V.CTS.081]

#### **4.3.4.2.5 ISS Safe Haven**

The spacecraft's safe haven capability while docked to the ISS with the hatch-closed for all crewmembers returning with the spacecraft shall be verified by analysis. The analysis shall include spacecraft consumables availability and margins, spacecraft functionality to supply the consumables in time to provide a safe haven, and the operational procedures for the safe haven contingency. The verification shall be considered successful when the analysis shows that the spacecraft can provide functionality and consumables (including spacecraft power, life support resources, and other commodities required to ensure crew survivability) to satisfy the safe haven requirement. [V.CTS.082]

#### **4.3.4.2.6 Alternate Landing Site**

The ability of the CTS to return NASA ISS crew to an alternate landing site shall be verified by analysis and inspection. A mission profile/timeline analysis shall be performed to identify alternate landing site opportunities. A functional analysis shall be performed to determine the ground system capabilities required at the landing site. The verification shall be considered successful when analysis of the timeline and ground system capabilities and the inspection of drawings, equipment lists, and landing site features determine that the site is available during a deorbit delay and ground system capabilities can support landing site operations. [V.CTS.337]

#### **4.3.4.2.7 Return after Failure to Dock**

The spacecraft's early return to a supported landing site following a failure to mate with the ISS on the final attempt after the 24 hour contingency re-rendezvous shall be verified by analysis. The analysis will evaluate crew timelines and landing opportunities, along with necessary consumables to perform the separation out to a safe deorbit location, perform the deorbit, and land at the supported site. Analysis will also include waiving-off the deorbit maneuver per 3.4.2.4. and 3.4.2.6. The verification shall be considered successful when worst case analyses show that the spacecraft can accomplish the mission planning and the spacecraft has adequate consumables to complete the mission for the ISS altitude ranging from 385 to 425 km for all cases where rendezvous failed per 3.4.2.3. [V.CTS.338]

#### **4.3.4.2.8 Integrated System Performance with Final Successful Rendezvous**

The spacecraft's integrated system performance for completing required operations shall be verified by analysis. An integrated system performance analysis shall be performed using the ISS altitude band of 385 to 425 km to determine consumables utilization beginning when ground services are terminated pre-launch, through docking at the most-stressing docking port, 210 days of docked operations, and ending with landing, while accommodating all specified contingency operations listed in this requirement. The simulation shall determine consumables required for system duty cycles assuming nominal systems performance based on dispersions on mass properties, engine, and subsystem performance, GN&C parameters, and environmental parameters. The verification shall be considered successful when analyses show that the spacecraft has consumables to complete the mission. [V.CTS.375]

#### **4.3.4.3 Orbital Debris**

##### **4.3.4.3.1 Expendable Module Disposal**

The verification of the disposal of expendable modules and other orbital debris shall be done by inspection and analysis. The atmospheric reentry risk analysis shall be utilized to show compliance with the human casualty risk criteria. The verification shall be considered successful when the inspection shows that mission design and CTS hardware have met NASA-STD-8719.14. [V.CTS.083]

##### **4.3.4.3.2 Collision Avoidance**

The CTS's capability to perform collision avoidance shall be verified by analysis and demonstration. Analysis shall be performed to show that launch can be delayed or an orbital maneuver can be executed to avoid a close encounter with orbital debris. Analysis shall also be performed to show that valid state covariance data can be produced in support of the Probability of Collision (Pc) method. Demonstration with integrated end-to-end simulations shall be performed to show that the CTS successfully executes the collision avoidance process with trackable orbital debris. The verification shall be considered successful when the analysis and demonstration show that CTS has the capability to produce valid state covariance data and insert maneuvers in the sequence to avoid collision with orbital debris during pre-launch and onorbit free-flight operations. [V.CTS.084]

#### **4.3.5 Entry/Landing Requirements**

##### **4.3.5.1 Nominal**

##### **4.3.5.1.1 RESERVED**

#### **4.3.5.1.2 Assisted Vehicle Egress**

The ability of the CTS to accommodate assisted crew egress of the entire crew in the pre-launch, post-landing, and contingency configurations and environments (reference 3.5.2.2 and 3.5.2.3) shall be verified by analysis and demonstration. A hazard analysis shall be utilized to identify which pre-launch, post-landing, and contingency configurations and conditions will drive conditions for assisted egress. The enveloping cases will be the basis for demonstration. The demonstration shall be performed in a flight-representative vehicle in flight configuration with a full crew complement and planned close-out, recovery, and rescue personnel. The Demonstration shall exercise all procedures and equipment to prepare and egress crew from the spacecraft with ground personnel assistance through all designated egress paths. Modeling analysis may be performed to supplement demonstrations. The verification shall be considered successful when the demonstration confirms ground crews can open the hatch from the outside, release the crew from the restraint system, and assist the entire crew in egressing the vehicle in pre-launch, landing, and contingency environments. [V.CTS.344]

#### **4.3.5.1.3 Visual Aids for Search and Rescue/Recovery**

The spacecraft's provisioning of visual aids for search and rescue/recovery in all ambient lighting conditions shall be verified by demonstration and analysis. For strobe lights/beacons, a demonstration shall be conducted using flight representative hardware that simulates the proper height, attitude, and obscurations (e.g. uprighting bags, deployed mechanisms needed for landing, position of waterline, etc.) of the spacecraft. This demonstration shall include viewing the test article from multiple heights of ground level, 500 feet, 1000 feet, 1500 feet, and 2000 feet altitudes at a minimum distance of 3 nautical miles during night and day Visual Meteorological Conditions (VMC). An analysis shall be conducted to determine that the spacecraft, any associated color markings, and any deployed visual markers provide sufficient color contrast with the surrounding landing terrain to allow rescue forces to locate the spacecraft in daylight from a minimum distance of 3 nm during VMC. The verification shall be considered successful when the demonstration shows that an observer can locate the spacecraft at a distance of 3 nautical miles from all demonstrated heights, lighting conditions, and angles during VMC, and that the analysis shows that the spacecraft, any associated color markings, and any deployed visual markers provide sufficient color contrast with the surrounding landing terrain to allow rescue forces to locate the spacecraft in daylight from a minimum distance of 3 nm during VMC. [V.CTS.088]

#### **4.3.5.1.4 Post-Landing Crew Services**

The CTS's provision of 2 hours of post-landing services after touchdown shall be verified by inspection and analysis. An operational analysis shall be performed to determine the post-landing crew tasks required to safe the vehicle and prepare for a recovery at a supported site. A performance analysis of CTS elements shall be performed to evaluate the functions and consumables required to provide a breathable atmosphere and crew cooling. An inspection of 3-D models shall determine the location of post-landing drinking water. The verification shall be considered successful when the analysis shows the CTS can maintain a breathable atmosphere per 3.10.11.1.1b,d, and accommodation of metabolic loads per 3.2.5.11.5 for 2 hours post-landing and the inspection shows the drinking water is within the range of motion of the crewmember in the landed configuration. [V.CTS.090]

#### **4.3.5.1.5 Orthostatic Protection**

The CTS's provisioning of crewmember orthostatic protection shall be verified by test. The test shall be performed with human subjects that represent the current male and female astronaut population range, and shall measure pressures applied by the flight suit to the calf, thigh, and abdominal segments of the body. The verification shall be considered successful when the test shows that the garment applies a mean pressure between 40 mmHg and 80 mmHg to the lower body segments. If pressures are graded, the garment shall apply the highest pressure at the foot/ankle with pressures decreasing up the leg, and lowest pressure over the abdomen to the level of the diaphragm. [V.CTS.091]

#### **4.3.5.1.6 Crew Egress Paths**

The CTS's ability to provide more than one crew egress path out of the spacecraft when in the landing configuration shall be verified by analysis and demonstration. Analysis shall be performed on engineering drawings and schematics to ensure that the spacecraft design has provided a post-landing alternate egress path for crewmembers in their entry clothing and equipment. Analysis on alternate egress hatch configuration, volume for crew maneuvering, and ability to open an alternate egress hatch with the crew in their normal entry configuration will be completed. A demonstration utilizing flight representative hardware and the required egress procedures shall be performed by crewmembers in the planned entry configuration, and nominal and off nominal vehicle orientations required for use of the alternate egress path. The verification shall be considered successful when the analysis of engineering data and demonstration results sufficiently document the ability to support crew egress through the alternate egress path for nominal and select off nominal spacecraft landing attitudes. [V.CTS.092]

#### **4.3.5.1.7 Communications with CVCC after Landing**

The spacecraft-provided two-way voice communication between the crew and the CVCC until crew disembarkation shall be verified by analysis and demonstration. The analysis shall be performed on the end-to-end communications path including radio device/equipment, spacecraft connection/cabling, spacecraft communications systems, and the CVCC communication equipment to satisfy a minimum of 2 hours talk time duration with CVCC after landing. A demonstration shall be performed to show the post-landing communications system, in a hatch closed configuration, can communicate with the CVCC. The demonstration shall be performed in environments representative of both supported and unsupported landing sites. The verification shall be considered successful when the demonstration shows the system can communicate between the crew in the spacecraft and the CVCC and the analysis shows communications can be maintained for a cumulative 2 hours over a 24 hour period. [V.CTS.095]

#### **4.3.5.1.8 Spacecraft Voice Communication with Recovery/Rescue Forces**

The spacecraft's crew communication with recovery/rescue forces until crew disembarkation shall be verified by analysis. The analysis shall be performed on the requirements and design of the vehicle, vehicle communications systems including portable devices, and the recovery/rescue forces communication equipment to verify that the spacecraft crew communication system to the recovery/rescue forces has sufficient power to operate continuously for a minimum of 4 hours, that the frequencies utilized by the crew and recovery forces are identical, that the crew can maintain communication with the recovery/rescue forces with the spacecraft egress hatches closed, and that the crew can communicate with rescue forces on IAD and MAD frequencies. The verification shall be considered successful when the analysis shows that communication



between the crew in the spacecraft and the recovery/rescue forces can be maintained for a minimum of 4 hours, which is the time assumed for the crew to disembark the spacecraft. [V.CTS.353]

#### **4.3.5.2 Contingency**

##### **4.3.5.2.1 Emergency Entry Capability**

The CTS's emergency systems for entry, descent, and landing (EDL) shall be verified by analysis and inspection. A crew survivability analysis shall be performed to select specific capabilities that could provide the crew an opportunity for survival in the event that the failure tolerance designed into the system is unsuccessful in controlling a potentially catastrophic hazard during EDL. The provider methodology, process, and plans for conducting the crew survivability analysis shall be consistent with CCT-PLN-1120 Section 4.2. An inspection shall be performed to ensure that the selected emergency systems are implemented in the CTS design. The verification shall be considered successful when the crew survivability analysis is complete and the inspection shows the CTS design includes the EDL emergency systems that provide the crew an opportunity for survival. [V.CTS.096]

##### **4.3.5.2.2 Sea State Landing Limits for Aborts**

The spacecraft's ability to function after water landing following an abort shall be verified by analysis. The analysis shall determine the worst-case water landing conditions for aborts based on dispersed atmosphere and sea state environments. These conditions are combined with the rescue design limitations defined in Figure 3.5.2.2-1 to form the basis of the analysis of spacecraft impact conditions with the water. The analysis shall use initial conditions based on spacecraft attitude motion during terminal descent, and the spacecraft shall impact the water with various wave slopes. An analysis shall be performed to identify systems that must function post-landing. The verification shall be considered successful when analysis confirms the spacecraft is able to structurally sustain the impact, with necessary spacecraft systems functional after impact. [V.CTS.373]

##### **4.3.5.2.3 Runway Landing Weather Limits for Aborts**

The spacecraft's ability to perform abort runway landings at the environmental limits shall be verified by analysis. The analysis shall consist of landing simulations using flight-representative software and validated mathematical models for GN&C hardware and flight control systems. The verification shall be considered successful when the analysis shows the spacecraft can perform the entire landing phase within design limits, landing intact and stopping on the runway, while satisfying the conditions in Table 3.5.2.3-1. [V.CTS.374]

##### **4.3.5.2.4 Crew Survival after Emergency Landing**

The spacecraft's provision for post-landing crew survival shall be verified by a crew survivability analysis, as defined in Section 4.2 of CCT-PLN-1120. The analysis shall define operational concepts, environments, spacecraft performance, and crew supplies necessary to support the crew for 24 hours after landing. An analysis shall evaluate the crew core body temperature based on the tasks and environment. The verification shall be considered successful when the analysis shows the spacecraft and portable equipment performance meet that required by the survivability analysis and the analysis shows core body temperature excursions above 100.5 °F but no greater than 102.6 °F are limited to less than 45 minutes cumulative, with the demonstrated system performance. [V.CTS.093]

#### **4.3.5.2.5 Spacecraft Ventilation for Emergency Landings**

The spacecraft's provision of post-emergency landing ventilation shall be verified by test and analysis. The test shall be performed with a flight representative cabin and ventilation system. The analysis shall determine the energy required to power the ventilation system commensurate with the crew survivability analysis. The verification shall be considered successful when the test shows 4 equivalent cabin air exchanges per crewmember per hour are achieved and the analysis shows sufficient power available post-landing to operate the ventilation system until crew egress. [V.CTS.364]

#### **4.3.5.2.6 Crew Survival Kit**

The spacecraft's provision of a crew survival kit shall be verified by inspection. The inspection shall identify the equipment and supplies present in the manifested survival kit are consistent with those determined by the crew survivability analysis developed in 4.3.5.2.4. The verification shall be considered successful when the inspection shows a crew survival kit supports all crewmembers for at least 24 hours following an emergency landing. [V.CTS.094]

#### **4.3.5.2.7 Support Crew Rescue After Emergency Landing**

The CTS shall verify the support for rescue of the flight crew by NASA-designated rescue forces in the event of an emergency landing at an unsupported landing site by analysis and inspection:

- a. An analysis shall be performed to identify any spacecraft-specific emergency rescue equipment required. There will be an inspection of emergency rescue equipment stowed on the spacecraft and provided to the NASA-designated rescue forces.
- b. An analysis shall be performed to identify any CTS-specific emergency rescue training and training aids required. There will be an inspection of the CTS-specific emergency rescue training curriculum and training aids to be provided to the NASA-designated rescue forces.
- c. An analysis shall be performed to determine the range and capabilities of CTS assets and resources planned for supported landings.

The verification shall be considered successful when the analysis and inspection show that the required spacecraft-specific emergency rescue equipment has been identified and sufficient quantities have been provided and that the CTS-specific emergency rescue training has been identified and developed and the capabilities of the CTS assets and resources available to support NASA-designated rescue forces are identified. [V.CTS.393]

### **4.3.5.3 Post-Landing Recovery**

#### **4.3.5.3.1 Recovery after Nominal Landing**

The ability of the CTS to provide recovery of the flight crew within 1 hour after landing at each supported landing site shall be verified by inspection and demonstration. The inspection shall review the nominal landing recovery timeline. A demonstration shall be performed to show that the personnel, facilities, facilities systems, and GSE are able to successfully recover the flight crew through assisted vehicle egress within 1 hour after landing at each supported landing site. The verification shall be considered successful when the inspection and demonstration show the CTS is capable of successfully recovering the flight crew within 1 hour after landing at each supported landing site. [V.CTS.097]

#### **4.3.5.3.2 RESERVED**

#### **4.3.5.3.3 RESERVED**

#### **4.3.5.3.4 RESERVED**

#### **4.3.5.3.5 Recovery Lighting at Supported Sites**

The ability of the CTS to perform recovery operations independent of all ambient lighting conditions shall be verified by analysis. The analysis shall include a review of CTS systems required to enable recovery operations during any ambient lighting conditions and can show that the flight systems, facility systems, and GSE will operate independent of all ambient lighting conditions for recovery operations at supported sites. Systems to be considered include tracking (optics and radar), recovery/rescue aids, imagery (ground and flight based), GSE, and facilities. The verification shall be considered successful when the analyses show that the flight and ground systems are capable to support recovery of flight elements independent of all ambient lighting conditions at supported sites. [V.CTS.101]

#### **4.3.5.3.6 NASA Personnel Accompanying Recovery**

The ability of the CTS to transport and deliver 30 NASA personnel and their equipment from a CTS-designated staging location to the supported landing site shall be verified by inspection. The inspection shall include a review of the transportation plan to verify transportation, accommodation, and delivery of 30 NASA personnel and their equipment from a mutually agreed CTS-designated staging location to the supported landing site. The verification shall be considered successful when the inspection shows that the transportation plan can accommodate all NASA personnel and their equipment that will be used during recovery operations in time to support the landing. [V.CTS.102]

#### **4.3.5.3.7 Transport NASA Personnel and Cargo from Landing Site**

The ability of the CTS to provide transportation and delivery of the NASA crew, returning time-critical cargo, additional 30 NASA personnel, and equipment to a Continental U.S. airport within 2 hours of the completion of the NASA medical assessment shall be verified by inspection. The inspection shall include a review of the transportation plan to verify transportation, accommodations appropriate for delivery of NASA deconditioned crew based on the landing site conditions, returning time-critical cargo, 30 NASA personnel and their equipment from a supported landing site to a Continental US Airport using CTS resources. An inspection shall review verification closure of SSP 50833, Section 3.1.1. The verification shall be considered successful when the inspection shows that the CTS is capable of providing transportation and delivering NASA crew, 30 NASA personnel, equipment, and time-critical cargo while maintaining cargo services per applicable sections of 50833, from the supported landing site to a Continental U.S. airport within 2 hours of the completion of the NASA medical assessment using air transportation or transportation appropriate to landing site conditions. [V.CTS.103]

#### **4.3.5.3.8 Contingency Medical Evacuation**

The ability of the CTS to provide medical evacuation to ill or injured crewmembers to a DMCF within 1 hour of crew egress shall be verified by analysis and demonstration. The analysis shall include a review of a medical evacuation plan, showing:

- a. That specifications of the transportation method to be used are appropriate for deconditioned crew and landing site conditions,
- b. Accommodation of the correct number of personnel per vehicle,

- c. The personnel certifications, equipment, procedures, and communication necessary for medical evacuation at each supported landing site.
- d. A demonstration shall be performed to determine re-entry clothing (e.g. suits) compatibility with medical evacuation equipment (e.g. stretcher). The verification shall be considered successful when the analysis of the medical evacuation plan and the demonstration show that all ill or injured crewmembers, the required number of qualified ATLS Physicians and Paramedics, and two additional NASA personnel can be transported to a DMCF within 1 hour of crew egress. [V.CTS.104]

### **4.3.6 Crew Health Support**

#### **4.3.6.1 RESERVED**

#### **4.3.6.2 Medical Hardware Interfaces**

The spacecraft's delivery of medical oxygen through a reserved port shall be verified through analysis, inspection, and test. The analysis shall determine the consumables required to support the injured crewmember for the duration of the crew return until egress without violating the oxygen concentration requirements, per 3.10.11.2.2 and without reducing services to the other crewmembers. An inspection of consumables budgets shall determine the consumables are available for this operation. The test shall determine the delivery pressure and maximum flowrate through the port to the intended respiratory equipment, while the system is supplying nominal services to the other crewmembers. The verification shall be considered successful when the test results show that oxygen can be delivered per Table 3.6.2 without violating the oxygen concentration requirements, per 3.10.11.2.2 and without reducing services to the other crewmembers, and the inspection and analysis determines consumables are budgeted for the required duration. [V.CTS.318]

#### **4.3.6.3 Privacy of Health and Medical Data**

The CTS's provision of ensured privacy of all crew health and medical data shall be verified by analysis and inspection. The analysis shall assess the collection, transmission and storage of medical data. The inspection shall review the command and control architecture against the unintentional access and distribution of crew medical and personal data. The verification shall be considered successful when the analysis and inspection show that the ground command and control architecture ensures the secure collection, transmission, storage and access to this data. [V.CTS.107]

#### **4.3.6.4 Health Stabilization**

The requirement to meet JSC 22538 shall be verified by analysis. The analysis shall evaluate operational plans and controls to ensure that non-NASA flight crew, mission-related personnel, facilities, procedures, and employee training reduce the risk that the crew will be exposed to communicable disease prior to the mission. The verification shall be considered successful when the analysis of CTS HSP plans and procedures shows that measures are in place to meet JSC 22538, Flight Crew Health Stabilization Program. [V.CTS.109]

### **4.3.7 Commercial Vehicle Control Center (CVCC)**

#### **4.3.7.1 Ground Monitoring and Operation**

The capabilities for ground personnel to monitor, operate, and control the integrated space vehicle and subsystems shall be verified by analysis and test. A functional analysis shall be performed to determine functions required to execute mission operations and operational controls to hazards. A functional allocation analysis shall be performed to determine the functions the ground personnel can control to execute the mission tasks and operational controls to hazards. Test simulations shall be performed with the CVCC(s) and an emulated integrated space vehicle to show that all functions can be executed in the required phases and vehicle modes per the functional analysis. The verification shall be considered successful when tests show that under the planned communications coverage the ground personnel can monitor, operate, and control the functions allocated to them necessary to execute the mission, prevent a catastrophic event, and prevent an abort. [V.CTS.110]

#### **4.3.7.2 RESERVED**

#### **4.3.7.3 CVCC/MCC-H Data Integration**

The capability of the CTS to exchange real-time mission support data between the CVCC and the NASA ISS MCC-H shall be verified by inspection and test. The inspection shall evaluate the Interface Control Document (ICD) or equivalent that captures the negotiated data types and interfaces between the CVCC and the NASA ISS MCC-H to provide real-time data. The test shall show that each data type and interface negotiated functions, as per the ICD or equivalent, support real-time mission operations. The test shall be an end-to-end test performed with the ground systems. The verification shall be considered successful when the inspection and test shows the CTS is capable of exchanging real-time mission support data between the CVCC and the NASA ISS MCC-H. [V.CTS.112]

### **4.3.8 Spacecraft**

#### **4.3.8.1 Communications**

##### **4.3.8.1.1 Voice Communication with Crew**

The CTS's provision of single failure tolerant two-way voice communication between CVCC(s) and the spacecraft shall be verified by demonstration, analysis, and inspection. An inspection shall be performed on the CVCC and spacecraft drawings and subsystem level test data to determine failure tolerance. An integrated demonstration shall be performed between the CVCC and the two-way voice communications system on the spacecraft. Analysis shall be used to address limitations on demonstration as well as to assess any adjustments due to constraints levied within the issued operational license. The verification shall be considered successful when inspection of drawings and subsystem test data are complete to show failure tolerance, and demonstration with analysis shows voice communications between the CVCC and the spacecraft can be provided from pre-launch through landing and during aborts. [V.CTS.113]

##### **4.3.8.1.2 Communications Coverage**

The CTS's provision of 90% communications coverage during the powered ascent flight phase and 65% during the entry flight phase shall be verified by analysis and inspection. The inspection shall consist of approved operational license for each of the radio frequency link(s) that provide the two-way voice and telemetry. The analysis shall derive an expected aggregate interference degradation based on an expected RF environment. Communication coverage is defined as successful link availability for nominal ascent and entry trajectories (to supported sites), and a communication link is established. Structural blockage, vehicle attitude, antenna

pointing direction, and trajectory shall be factored into the analysis. The verification shall be considered successful when the analysis meets the criteria specified in CCT-STD-1140 Section 7.1.11.1 and shows that the spacecraft has 90% communications coverage (two-way voice and telemetry) during the ascent flight phase and 65% coverage during the entry flight phase in the expected RF environment and under the conditions granted in link radio licenses. [V.CTS.114]

#### **4.3.8.1.3 RESERVED**

#### **4.3.8.1.4 Private Audio**

The CTS's two-way private voice communication shall be verified by demonstration. The demonstration shall be between a flight representative vehicle and the designated mission control center flight control team positions. The verification shall be considered successful when the demonstration shows that audio transmitted between the vehicle and the mission control center can only be heard on orbit and at the designated flight control team positions. [V.CTS.116]

#### **4.3.8.1.5 Integrated Voice Communications during ISS Proximity and Docked Operations**

The CTS's provision of simultaneous two-way voice communications between the ISS, CTS spacecraft, CVCC, and ISS Mission Control Center shall be verified by analysis and test. The analysis shall include simulation of the end-to-end voice communications design, free flight to and from ISS operational scenarios, docked operational scenarios, and conditions that could impact the communications effectiveness. The testing shall include end-to-end testing, including interfaces, and shall be performed with flight representative systems. The verification shall be considered successful when the analysis, supported by the testing, shows that the CTS will support two-way voice communications between ISS, CTS spacecraft, CVCC, and ISS Mission Control Center for all planned docked operations and free flight operations when the CTS spacecraft is within 10 km of the ISS. [V.CTS.117]

#### **4.3.8.1.6 RESERVED**

#### **4.3.8.1.7 Command and Telemetry Communications**

The CTS's provision of single failure tolerant command and telemetry communication between CVCC(s) and the spacecraft shall be verified by demonstration, analysis, and inspection. An inspection shall be performed on the CVCC and spacecraft drawings and subsystem level test data to determine failure tolerance. An integrated demonstration shall be performed between the CVCC and the command and telemetry communication system on the spacecraft. Analysis shall be used to address limitations on demonstration as well as to assess any adjustments due to constraints levied within the issued operational license. Verification of this requirement shall be considered successful when inspection of drawings and subsystem test data are complete to show failure tolerance and demonstration with analysis shows command and telemetry communication between the CVCC and the spacecraft can be provided from pre-launch through landing and during aborts. [V.CTS.351]

#### **4.3.8.1.8 Communication**

The communications performance and compatibility with existing users of the same spectrum shall be verified through analysis. The analysis shall assess verification closures of allocated performance requirements and spectrum standards. The verification shall be considered successful when the analysis shows that allocated performance and compatibility with other

spectrum users' criteria shown in the "Communications" and "Spectrum Utilization" sections of CCT-STD-1140 have been met. [V.CTS.380]

#### **4.3.8.2 Command Link Security**

##### **4.3.8.2.1 Advanced Encryption Standards**

The hardware and software for encryption and decryption module requirements for all launch vehicle and spacecraft commanding, excluding FTS commanding, shall be verified by inspection and demonstration. The inspection shall review the implementation methods and laboratory test results, along with NIST validation certificates. Specific use of the algorithm shall be demonstrated on the hardware employed for the CTS. The verification shall be considered successful when inspection and demonstration show that the Federal Information Processing Standard (FIPS) Publication 197, Advance Encryption Standard (AES) has been implemented in accordance with FIPS Pub 140-2, FIPS Pub 46-3, and ANSI 9.52 certification, for a security Level 2. A NIST-validated Laboratory (e.g., INFOGARD) is responsible for performing the verification. [V.CTS.122]

##### **4.3.8.2.2 Requirements for Cryptographic Modules**

The performance of cryptographic operations using devices have met FIPS Publication 140-2 shall be verified by inspection and demonstration. The inspection shall review the security level 2 allocated verification closures and laboratory test results. Role-based authentication shall be demonstrated on the system employed for the CTS. The verification shall be considered successful when the inspection and demonstration show that FIPS Publication 140-2, certification for a security Level 2 has been met. A NIST validated Laboratory (e.g., INFOGARD) is responsible for performing the verification. [V.CTS.123]

##### **4.3.8.2.3 Cryptographic Key Management**

The CTS management of cryptographic keys shall be verified by inspection. The inspection shall review the allocated verification closures of protection requirements and the distribution and storage of cryptographic and cryptographic related data. The verification shall be considered successful when the inspection shows that the National Institute of Standards and Technology (NIST) SP 800-57, Recommendation for Key Management-Part 1 has been satisfied. [V.CTS.124]

#### **4.3.8.3 Onorbit Maintenance**

##### **4.3.8.3.1 Preventative Maintenance**

The requirement of the spacecraft to need no more than 2 crew hours of IVA for preventative maintenance every 30 days during ISS docked operations shall be verified by analysis. The analysis shall include the review of the as-built spacecraft design and the planned maintenance activities and procedures. The verification shall be considered successful when the analysis shows the planned IVA preventive maintenance can be accomplished in less than 2 crew hours every 30 days during ISS docked operations. [V.CTS.126]

##### **4.3.8.3.2 Maintenance Tools**

The CTS's provision for a set of in-flight tools shall be verified by inspection. The verification shall be considered successful when inspections shows that all the unique tools required for onorbit maintenance and reconfiguration have been provided. [V.CTS.127]

#### **4.3.8.4 Manual Control**

##### **4.3.8.4.1 Manual Control of Vehicle Flight Path**

Crew manual control of the vehicle flight path, attitude, and attitude rates shall be verified by analysis and test. Analysis shall be performed to show that manual control capability for vehicle flight path, attitude, and attitude rates is controllable and stable for a dispersed set of inputs that includes hand controller inputs. The testing shall use a GN&C simulation integrated with a pilot-in-the-loop test facility, with flight-representative hand controllers, displays, and out-the-window scenes. Testing shall use these facilities to capture and analyze manual control performance of the vehicle on a set of scenarios representative of the manual control capabilities available. The verification shall be considered successful when analysis and test results show that manual control capability is provided without violating structural, thermal, performance margins, and the budgeted timeline for these tasks for all relevant flight phases.

See CCT-STD-1140, "Flight Mechanics and GN&C Technical Assessment" section for technical verification expectations pertinent to flight mechanics. [V.CTS.128]

##### **4.3.8.4.2 Manual Piloting for Docking**

Crew manual piloting to accomplish docking shall be verified by analysis and test. An analysis shall be conducted to identify the crew tasks required to execute manual piloting for docking within the approach ellipse. Analysis shall be performed to show that manual piloting capability for docking tasks is controllable and stable for a dispersed set of inputs that includes hand controller inputs. The testing shall use a GN&C simulation integrated with a pilot-in-the-loop test facility, with flight-representative hand controllers, displays, flight data, avionics, software, and out-the-window scenes. Testing shall use these facilities to capture and analyze manual piloting performance of the vehicle for docking and shall include system and environment dispersions. Testing shall include all crew tasks necessary to accomplish manual piloting for docking including tasks necessary to control catastrophic hazards. The verification shall be considered successful when analysis and test results show that manual piloting capability is provided without violating structural, thermal, performance margins, and the budgeted timeline for these tasks for docking.

See CCT-STD-1140, "Flight Mechanics and GN&C Technical Assessment" section for technical verification expectations pertinent to flight mechanics. [V.CTS.385]

##### **4.3.8.4.3 Handling Qualities**

Handling qualities shall be verified by analysis and test. Selected manual control scenarios will be defined via review of potential manual control scenarios and associated manual control modes (as identified in 3.8.4.1 and 3.8.4.2, 3.8.5.1.1, and 3.5.2.1). Analysis shall be performed to select the manual control scenarios selected for testing and required handling qualities ratings. Manual control scenarios shall be selected based on the following considerations; 1) manual control scenarios necessary to meet 3.8.4.2 Manual Piloting for Docking, 2) catastrophic hazard controls that utilize manual control capabilities as part of their mitigation strategy, and 3) manual control scenarios that are uniquely different or more complex than Manual Piloting for Docking. For each selected scenario, a list of handling quality related tasks will be generated as part of a task analysis. A handling quality related task is defined as the manual control capability that is being rated with the Cooper-Harper Rating Scale. Each task within a scenario is rated separately and must meet Level 1 (handling quality ratings of 1, 2, or 3). A test shall be conducted for each



selected scenario with at least five test subjects trained as pilots for the particular spacecraft being evaluated and trained in Cooper-Harper evaluations. Test subjects shall perform the manual control scenarios in flight configuration in a flight representative cockpit and provide Cooper-Harper evaluations for each task in the scenario. The verification shall be considered successful when the analysis and test show that for each task associated with each of the selected manual control scenarios where manual control is the primary control method or where the automated control system is non-operational, at least 60% of the ratings are Level 1 (handling quality ratings of 1, 2 or 3), while up to 40% may exceed Level 1 with a Level 2 rating (handling quality rating of 4, 5, or 6). For any ratings of 4, 5, or 6 to be considered successful, a consensus must be reached by all of the participants indicating that handling qualities are acceptable. For all other scenarios, at least 80% of the ratings must be Level 1 or 2 (HQR of 1, 2, 3, 4, 5 or 6), while up to 20% may exceed Level 2 with a Level 3 rating (HQR of 7, 8 or 9). For any ratings of 7, 8 or 9 to be considered successful, a consensus must be reached by all of the participants indicating that handling qualities are acceptable. [V.CTS.129]

#### **4.3.8.4.4 Windows for Crew Tasks**

Window fields-of-view for expected crew viewing tasks shall be verified by analysis and demonstration. The analysis shall identify nominal and off-nominal tasks requiring visual information from outside of the spacecraft and include simulations of operational scenarios depicting the interior and exterior of the vehicle. The analysis shall provide a graphical depiction of the lines of sight through the fields-of-view of the windows with respect to their installation in the system. The demonstration shall evaluate the adequacy of the positioning of, and fields of view provided by, the windows for crew tasks in a flight representative vehicle with the crew in the flight configuration and to ensure there are no obstructions to viewing within the fields of view. The verification shall be considered successful when the analysis shows that the windows provide the unobstructed fields-of-view necessary to support expected crew viewing tasks and the demonstration shows that the viewing tasks can be accomplished. [V.CTS.177]

#### **4.3.8.5 Crew Interface**

##### **4.3.8.5.1 General Crew Interfaces**

###### **4.3.8.5.1.1 Crew Control of Vehicle**

The capabilities for the crew to monitor, operate, and control the integrated space vehicle and subsystems shall be verified by analysis and test. A functional analysis shall be performed to determine functions required to execute mission operations, capabilities required for operational control of catastrophic hazards, and capabilities required for preventing an abort. A functional allocation shall be performed to determine the functions the crew can control to execute the mission tasks, operationally control catastrophic hazards, and prevent an abort. A test shall be performed with crew in flight configuration in a flight-representative vehicle to show that all functions can be executed in the required phases and vehicle modes per the functional analysis. The verification shall be considered successful when test shows that the crew can monitor, operate, and control the functions allocated to them to fully execute the mission, prevent a catastrophic event, and prevent an abort. [V.CTS.130]

###### **4.3.8.5.1.2 Tolerate Inadvertent Action**

The CTS's ability to tolerate an inadvertent operator action without causing a catastrophic event shall be verified by analysis and demonstration. A task analysis shall be performed to identify

human interactions required for operations and control of the system, including responses to system failures. A human error analysis (HEA) shall be performed, as defined in Section 4.7 of CCT-PLN-1120. The HEA shall define the source of human errors derived from these tasks and the design and operational controls to mitigate or limit the effects. A system performance analysis shall be performed to determine the operational impact of the inadvertent action. A demonstration of human system interaction tasks shall be performed with simulated errors utilizing flight representative hardware and software in the flight configuration. The verification shall be considered successful when the performance analysis and demonstration shows that the design can tolerate the inadvertent operator action without causing a catastrophic event. [V.CTS.131]

#### **4.3.8.5.1.3 Controls for Human Error**

The CTS implementation of human error controls shall be verified by analysis, inspection, and demonstration. A task analysis shall be performed to identify human interactions required for the maintenance, operations and control of the system. A human error analysis (HEA) shall be performed, as defined in Section 4.7 of CCT-PLN-1120. The HEA shall define the source of human errors derived from the tasks and the design and operational controls to mitigate or limit the effects. An inspection of drawings and hardware shall confirm maintenance and operational controls for human error have been incorporated. A demonstration of human system interaction tasks shall be performed with simulated errors utilizing flight representative hardware and software. The verification shall be considered successful when the inspection shows that design and operational controls have been implemented for those sources of errors identified in the HEA, and the demonstration shows that the mitigation is effective at preventing the error or the system allows the human to detect and correct or recover from the errors. [V.CTS.132]

#### **4.3.8.5.1.4 Tolerate Inadvertent Action during Failure**

The CTS's ability to tolerate inadvertent operator action in the presence of any single system failure shall be verified by analysis and demonstration. A task analysis shall be performed to identify human interactions required for operations and control of the system, including responses to system failures. A human error analysis (HEA) shall be performed, as defined in Section 4.7 of CCT-PLN-1120. The HEA shall define the source of human errors derived from these tasks and the design and operational controls to mitigate or limit the effects in the presence of a single system failure. A system performance analysis shall be performed to determine the operational impact of the inadvertent action in the presence of a single system failure. A demonstration of human system interaction tasks shall be performed with simulated errors utilizing flight representative hardware and software in the flight configuration that represents the simulated system failure. The verification shall be considered successful when the performance analysis and demonstration shows that the design can tolerate the inadvertent operator action in the presence of a single system failure without causing a catastrophic event. [V.CTS.134]

#### **4.3.8.5.1.5 Operable by Single Crewmember**

Spacecraft operability by a single crewmember shall be verified by analysis and demonstration. An operational task analysis shall be completed to ensure all accommodations for single crew operability have been considered in the design phase. A demonstration shall be performed with a single crewmember in flight configuration in a flight representative cockpit that verifies a single crewmember can accomplish all necessary tasks. The verification shall be considered successful

when the demonstration and analysis show that the system is operable by any one crewmember for operations requiring crew control. [V.CTS.135]

## **4.3.9 Spacecraft and Launch Vehicle Design Manufacturing Standards**

### **4.3.9.1 Materials and Processes**

#### **4.3.9.1.1 Materials and Processes**

The application of NASA- STD-6016 or approved alternative standard to the CTS shall be verified by inspection. The inspection shall review verification closure of allocations of the approved standard to design and production elements. The verification shall be considered successful when the inspection shows that allocated CTS design and production elements have met NASA- STD-6016 or the approved alternative standard. [V.CTS.260]

#### **4.3.9.1.2 Cabin Materials Flammability**

The materials used in the spacecraft cabin shall be verified to meet the flammability requirements of NASA-STD-6016 in 30% oxygen at a pressure of 10.2 psia by inspection, test, and analysis. The inspection shall consist of comparing the materials used in the spacecraft cabin with the existing M&P database. Test and analysis shall be performed to verify compliance with the flammability requirements of NASA-STD-6016 where the material is not in the existing M&P database. The verification shall be considered successful when the inspection, test, and analysis show that all materials used in the spacecraft cabin meet the flammability requirements of NASA-STD-6016. [V.CTS.376]

### **4.3.9.2 Flight and Ground Software**

#### **4.3.9.2.1 Software Engineering Requirements**

The application of 7150.2A or approved alternative standard to the CTS shall be verified by inspection. The inspection shall review verification closure of allocations of the approved standard to design and production elements. The verification shall be considered successful when the inspection shows that allocated CTS design and production elements have met 7150.2A or the approved alternative standard. [V.CTS.262]

### **4.3.9.3 Electrical and Avionics**

#### **4.3.9.3.1 Use of Silver**

##### **4.3.9.3.1.1 Electrically Deposited Silver**

The prohibited use of electrically deposited silver as plating on printed wiring boards and terminal boards shall be verified by inspection. The verification shall be considered successful when an inspection of the end item drawings show that electrically deposited silver is not used as plating on printed wiring boards and terminal boards. [V.CTS.266]

##### **4.3.9.3.1.2 Silver Plating**

The prohibited use of electrically deposited silver as plating on bus bars and mechanical electrical contacts, such as connector pins and sockets shall be verified by inspection. The verification shall be considered successful when an inspection of the end item drawings show that electrically deposited silver is not used as plating on bus bars and mechanical electrical contacts, such as connector pins and sockets. [V.CTS.267]

##### **4.3.9.3.2 RESERVED**

### **4.3.9.3.3 Printed Wiring Boards**

#### **4.3.9.3.3.1 Printed Board Design Standards**

The application of IPC-2221 and the associated technology performance specification under the IPC 2220 series per performance Class 3 or approved alternative standards to the CTS shall be verified by inspection. The inspection shall review verification closure of allocations of the approved standard to design and production elements. The verification shall be considered successful when the inspection shows that allocated CTS design and production elements have met IPC-2221 and the associated technology performance specification under the IPC 2220 series per performance Class 3 or the approved alternative standards. [V.CTS.268]

#### **4.3.9.3.3.2 Qualification of Printed Boards Standard**

The application of IPC-6011 and the associated technology performance specification under the IPC-6010 series or approved alternative standards to the CTS shall be verified by inspection. The inspection shall review verification closure of allocations of the approved standard to design and production elements. The verification shall be considered successful when the inspection shows that allocated CTS design and production elements have met IPC-6011 and the associated technology performance specification under the IPC-6010 series or the approved alternative standards. [V.CTS.269]

#### **4.3.9.3.3.3 Conductor Size Standard**

The application of IPC-2152 or approved alternative standard to the CTS shall be verified by inspection. The inspection shall review verification closure of allocations of the approved standard to design and production elements. The verification shall be considered successful when the inspection shows that allocated CTS design and production elements have met IPC-2152 or the approved alternative standard. [V.CTS.270]

### **4.3.9.3.4 Printed Wiring Assemblies**

#### **4.3.9.3.4.1 Printed Wiring Assemblies**

Electrical circuitry design and fabrication to prevent the production of unwanted current paths caused by debris or foreign materials floating in the spacecraft shall be verified by inspection, analysis, and test. [V.CTS.271]

### **4.3.9.3.5 Fiber Optics**

#### **4.3.9.3.5.1 RESERVED**

#### **4.3.9.3.5.2 Fiber Optic Connection Standard**

The application of NASA-STD-8739.5 or approved alternative standard to the CTS shall be verified by inspection. The inspection shall review verification closure of allocations of the approved standard to design and production elements. The verification shall be considered successful when the inspection shows that allocated CTS design and production elements have met NASA-STD-8739.5 or the approved alternative standard. [V.CTS.273]

### **4.3.9.3.6 Staking/Conformal Coating**

#### **4.3.9.3.6.1 Staking/Conformal Coating**

The application of NASA-STD- 8739.1 or approved alternative standard to the CTS shall be verified by inspection. The inspection shall review verification closure of allocations of the

approved standard to design and production elements. The verification shall be considered successful when the inspection shows that allocated CTS design and production elements have met NASA-STD- 8739.1 or the approved alternative standard. [V.CTS.274]

#### **4.3.9.3.7 Electrical Soldering**

##### **4.3.9.3.7.1 Soldering Process and Controls Standard**

The application of IPC J-STD-001ES or approved alternative standard to the integrated space vehicle shall be verified by inspection. The inspection shall review verification closure of allocations of the approved standard to design and production elements. The verification shall be considered successful when the inspection shows that allocated integrated space vehicle design and production elements have met IPC J-STD-001ES or the approved alternative standard. [V.CTS.275]

##### **4.3.9.3.7.2 RESERVED**

##### **4.3.9.3.7.3 Soldering Performance Standard**

The application of GEIA-STD-0005-1 or approved alternative standard to the CTS shall be verified by inspection. The inspection shall review verification closure of allocations of the approved standard to design and production elements. The verification shall be considered successful when the inspection shows that allocated CTS design and production elements have met GEIA-STD-0005-1 or the approved alternative standard. [V.CTS.277]

##### **4.3.9.3.7.4 Mitigation of Tin Whiskers**

The application of GEIA-STD-0005-2 or approved alternative standard to the CTS shall be verified by inspection. The inspection shall review verification closure of allocations of the approved standard to design and production elements. The verification shall be considered successful when the inspection shows that allocated CTS design and production elements have met GEIA-STD-0005-2 or the approved alternative standard. [V.CTS.278]

#### **4.3.9.3.8 Electrical Crimping**

##### **4.3.9.3.8.1 Wiring, Cables, Harnesses and Crimping**

The application of NASA- STD-8739.4 or approved alternative standard and SAE-AS-7928 to the CTS shall be verified by inspection. The inspection shall review verification closure of allocations of the approved standard to design and production elements. The verification shall be considered successful when the inspection shows that allocated CTS design and production elements have met NASA- STD-8739.4 or approved alternative standard and SAE-AS-7928. [V.CTS.279]

#### **4.3.9.3.9 Electrical Wire Wrapped Connections**

##### **4.3.9.3.9.1 Electrical Wire Wrapped Connections**

An inspection of the end item drawings and process sampling of hardware shall verify that wire wrapping has not been used. [V.CTS.280]

#### **4.3.9.3.10 Electrical Bonding**

##### **4.3.9.3.10.1 Electrical Bonding**

The application of NASA-STD-4003 or approved alternative standard to the integrated space vehicle shall be verified by inspection. The inspection shall review verification closure of allocations of the approved standard to design and production elements. The verification shall be considered successful when the inspection shows that allocated integrated space vehicle design and production elements have met NASA-STD-4003 or the approved alternative standard. [V.CTS.281]

#### **4.3.9.3.11 Batteries**

##### **4.3.9.3.11.1 Batteries**

The application of JSC 20793 or approved alternative standard to the integrated space vehicle shall be verified by inspection. The inspection shall review verification closure of allocations of the approved standard to design and production elements. The verification shall be considered successful when the inspection shows that allocated integrated space vehicle design and production elements have met JSC 20793 or the approved alternative standard. [V.CTS.282]

#### **4.3.9.3.12 Other Processes**

##### **4.3.9.3.12.1 RESERVED**

##### **4.3.9.3.12.2 Component Mounting Guidelines**

The application of IPC-CM-770E or approved alternative standard to the CTS shall be verified by inspection. The inspection shall review verification closure of allocations of the approved standard to design and production elements. The verification shall be considered successful when the inspection shows that allocated CTS design and production elements have met IPC-CM-770E or the approved alternative standard. [V.CTS.284]

#### **4.3.9.3.13 Integrated Space Vehicle Electrostatic Charge Control**

##### **4.3.9.3.13.1 LEO Charging Design Standard**

The application of NASA-STD- 4005 or approved alternative standard to the spacecraft shall be verified by inspection. The inspection shall review verification closure of allocations of the approved standard to design and production elements. The verification shall be considered successful when the inspection shows that allocated spacecraft design and productions elements have met NASA-STD- 4005 or the approved alternative standard. [V.CTS.285]

##### **4.3.9.3.13.2 Electrostatic Discharge Control Program**

The application of ANSI/ESD S20.20 or approved alternative standard to the CTS shall be verified by inspection. The inspection shall review verification closure of allocations of the approved standard to design and production elements. The verification shall be considered successful when the inspection shows that allocated CTS design and production elements have met ANSI/ESD S20.20 or the approved alternative standard. [V.CTS.286]

##### **4.3.9.3.13.3 Electrostatic Design Thresholds**

The application of IEC 61000-4-2 or approved alternative standard to the CTS shall be verified by inspection. The inspection shall review verification closure of allocations of the approved standard to design and production elements. The verification shall be considered successful when the inspection shows that allocated CTS design and production elements have met IEC 61000-4-2 or the approved alternative standard. [V.CTS.371]

#### **4.3.9.3.14 Electromagnetic Interference Control**

##### **4.3.9.3.14.1 Electromagnetic Interference Control**

The application of MIL-STD-461 or approved alternative standard to the integrated space vehicle shall be verified by inspection. The inspection shall review verification closure of allocations of the approved standard to design and production elements. The verification shall be considered successful when the inspection shows that allocated integrated space vehicle design and production elements have met MIL-STD-461 or the approved alternative standard. [V.CTS.287]

#### **4.3.9.3.15 Electromagnetic Environmental Effects**

##### **4.3.9.3.15.1 Electromagnetic Environmental Effects**

The application of MIL-STD-464 or approved alternative standard to the integrated space vehicle shall be verified by inspection. The inspection shall review verification closure of allocations of the approved standard to design and production elements. The verification shall be considered successful when the inspection shows that allocated integrated space vehicle design and production elements have met MIL-STD-464 or the approved alternative standard. [V.CTS.288]

#### **4.3.9.3.16 Custom Electromagnetic Devices**

##### **4.3.9.3.16.1 Custom Electromagnetic Devices**

The application of MIL-STD-981 or approved alternative standard to the integrated space vehicle shall be verified by inspection. The inspection shall review verification closure of allocations of the approved standard to design and production elements. The verification shall be considered successful when the inspection shows that allocated integrated space vehicle design and production elements have met MIL-STD-981 or the approved alternative standard. [V.CTS.289]

#### **4.3.9.3.17 Lightning**

##### **4.3.9.3.17.1 Lightning Protection Design**

The application of SAE ARP 5412A, FAA AC 20-136B, SAE ARP 5414A and SAE ARP 5577 or approved alternative standards to the integrated space vehicle shall be verified by inspection. The inspection shall review verification closure of allocations of the approved standard to design and production elements. The verification shall be considered successful when the inspection shows that allocated integrated space vehicle design and production elements have met SAE ARP 5412A, FAA AC 20-136A, SAE ARP 5414A and SAE ARP 5577 or the approved alternative standards. [V.CTS.290]

#### **4.3.9.4 Aerodynamic Deceleration Systems**

##### **4.3.9.4.1 Trailing Deployable Aerodynamic Decelerator**

###### **4.3.9.4.1.1 Trailing Deployable Aerodynamic Decelerator Design**

The application of JSC 65985 or approved alternative standard to the integrated space vehicle shall be verified by inspection. The inspection shall review verification closure of allocations of the approved standard to design and production elements. The verification shall be considered successful when the inspection shows that allocated integrated space vehicle design and production elements have met JSC 65985 or the approved alternative standard. [V.CTS.291]

#### **4.3.9.5 Mechanisms**

#### **4.3.9.5.1 Mechanism Design**

The application of NASA-STD-5017 (excluding sections 4.7 and 4.8.9) or approved alternative standard to the integrated space vehicle shall be verified by inspection. The inspection shall review verification closure of allocations of the approved standard to design and production elements. The verification shall be considered successful when the inspection shows that allocated integrated space vehicle design and production elements have met NASA-STD-5017 (excluding sections 4.7 and 4.8.9) or the approved alternative standard. [V.CTS.292]

#### **4.3.9.6 Thermal Protection System (TPS)**

##### **4.3.9.6.1 Thermal Protection System (TPS) Design**

The application of JSC 65827 or approved alternative standard to the spacecraft shall be verified by inspection. The inspection shall review verification closure of allocations of the approved standard to design and production elements. The verification shall be considered successful when the inspection shows that allocated spacecraft design and production elements have met JSC 65827 or the approved alternative standard. [V.CTS.293]

##### **4.3.9.6.2 TPS Structural Design**

The application of standards listed in section 3.9.8 or approved alternative standards to the integrated space vehicle TPS shall be verified by inspection. The inspection shall review verification closure of allocations of the approved standard to design and production elements. The verification shall be considered successful when the inspection shows that allocated integrated space vehicle design and production elements have met the standards listed in section 3.9.8 or the approved alternative standards. [V.CTS.372]

#### **4.3.9.7 Pyrotechnics**

##### **4.3.9.7.1 Pyrotechnics**

The application of JSC 62809 or approved alternative standard to the CTS shall be verified by inspection. The inspection shall review verification closure of allocations of the approved standard to design and production elements. The verification shall be considered successful when the inspection shows that allocated CTS design and production elements have met JSC 62809 or the approved alternative standard. [V.CTS.294]

#### **4.3.9.8 Structures**

##### **4.3.9.8.1 Structural Design and Factors of Safety**

###### **4.3.9.8.1.1 Structural Design Requirements**

The application of JSC 65828 or approved alternative standard to the integrated space vehicle (excluding glass and ceramic windows) shall be verified by inspection. The inspection shall review verification closure of allocations of the approved standard to design and production elements. The verification shall be considered successful when the inspection shows that allocated integrated space vehicle design and production elements (excluding glass and ceramic windows) have met JSC 65828 or the approved alternative standard. [V.CTS.295]

###### **4.3.9.8.1.2 Windows Design**

The application of NASA-STD-5018 or approved alternative standard to the integrated space vehicle shall be verified by inspection. The inspection shall review verification closure of



allocations of the approved standard to design and production elements. The verification shall be considered successful when the inspection shows that allocated integrated space vehicle design and production elements have met NASA-STD-5018 or the approved alternative standard.

[V.CTS.296]

#### **4.3.9.8.2 Loads and Structural Dynamics**

##### **4.3.9.8.2.1 Loads and Structural Dynamics**

The application of JSC 65829 or approved alternative standard to the integrated space vehicle shall be verified by inspection. The inspection shall review verification closure of allocations of the approved standard to design and production elements. The verification shall be considered successful when the inspection shows that allocated integrated space vehicle design and production elements have met JSC 65829 or the approved alternative standard. [V.CTS.297]

#### **4.3.9.8.3 Fasteners**

The application of NASA-STD-5020 or approved alternative standard to the integrated space vehicle shall be verified by inspection. The inspection shall review verification closure of allocations of the approved standard to design and production elements. The verification shall be considered successful when the inspection shows that allocated integrated space vehicle design and production elements have met NASA-STD-5020 or the approved alternative standard.

[V.CTS.298]

#### **4.3.9.9 Fluids, Propellants, Explosives, and Oxygen Systems**

##### **4.3.9.9.1 Flexible Lines and Flow-Induced Vibration**

The design of the CTS metal bellows and flexhoses to prevent flow-induced vibration (FIV) in the operating flow range +/-10% shall be verified by analysis. The analysis shall meet the intent of MSFC-DWG-20M02540. The verification shall be considered successful when the analysis shows no FIV exists.

If FIV is predicted by the analysis and no alternative design solutions exist to eliminate FIV, then the design shall be verified by performing a flow test. The test shall meet the intent of MSFC-SPEC-626. The verification shall be considered successful when the test shows the part life is four times the operational life with no failure.

For bellows and flexhoses used in ground systems and ground equipment, whose failure does not pose a critical hazard and where the analysis shows FIV to exist over the operating flow range +/-10 %, the design shall be verified by performing a fatigue life assessment analysis. The verification shall be considered successful when the analysis shows a theoretical infinite life.

The design of CTS metal bellows and flexhoses with atypical flow environments shall be verified by an alternative analysis and test. The alternative analysis approach shall be performed to determine if any FIV occurs over the operating flow range +/-10%. A test shall be performed to show the alternative analysis approach is valid. The verification of the alternative analysis approach shall be considered successful when the alternative analysis is shown to be valid by the test program. [V.CTS.303]

#### **4.3.9.10 Propulsion Systems**

##### **4.3.9.10.1 Strength and Life Requirements for Propulsion Systems**

The application of NASA-STD-5012 or approved alternative standard to the integrated space vehicle shall be verified by inspection. The inspection shall review verification closure of allocations of the approved standard to design and production elements. The verification shall be considered successful when the inspection shows that allocated integrated space vehicle design and production elements have met NASA-STD-5012 or the approved alternative standard. [V.CTS.304]

#### **4.3.9.11 Fracture Control**

##### **4.3.9.11.1 Fracture Control**

The application of NASA-STD-5019 or approved alternative standard to the integrated space vehicle shall be verified by inspection. The inspection shall review verification closure of allocations of the approved standard to design and production elements. The verification shall be considered successful when the inspection shows that allocated integrated space vehicle design and production elements have met NASA-STD-5019 or the approved alternative standard. [V.CTS.307]

#### **4.3.9.12 Parts**

##### **4.3.9.12.1 Parts**

The application of SMC-S-010 or approved alternative standard to the CTS shall be verified by inspection. The inspection shall review verification closure of allocations of the approved standard to design and production elements. The verification shall be considered successful when the inspection shows that allocated CTS design and production elements have met SMC-S-010 or the approved alternative standard. [V.CTS.319]

#### **4.3.9.13 Testing**

##### **4.3.9.13.1 Ground Testing**

The application of SMC-S- 016 or approved alternative standard to the integrated space vehicle shall be verified by inspection. The inspection shall review verification closure of allocations of the approved standard to design and production elements. The verification shall be considered successful when the inspection shows that allocated integrated space vehicle design and production elements have met SMC-S- 016 or the approved alternative standard. [V.CTS.315]

#### **4.3.9.14 Models and Simulations**

##### **4.3.9.14.1 Models and Simulations**

The application of sections 4.1.1, 4.1.2, 4.7 and 4.8 of NASA-STD-7009 to the CTS shall be verified by inspection. The inspection shall review verification closure of allocations of the approved standard to design and production elements. The verification shall be considered successful when the inspection shows that allocated CTS design and production elements have met sections 4.1.1, 4.1.2, 4.7 and 4.8 of NASA-STD-7009 or the approved alternative standard. [V.CTS.381]

#### **4.3.10 Human Health, Medical and Performance**

##### **4.3.10.1 Human Interface Design Standards**

The CTS's ability to meet the intent of the human integration design requirements shall be verified by inspection. The inspection shall consist of an inspection of records from test,

analyses, and demonstrations of Appendix Q design requirements. The verification shall be considered successful when the inspection shows that verification of requirements or their accepted alternatives in Appendix Q are complete. [V.CTS.343]

#### **4.3.10.2 Crew Acceleration and Vibration Limitations**

##### **4.3.10.2.1 Sustained Translational Acceleration Limits**

The crew exposure to sustained linear acceleration shall be verified by analysis. The analysis shall use a validated simulation to identify and assess bounding acceleration cases including GN&C, vehicle, and environmental dispersions. The verification shall be considered successful when the analyses indicates that simulated linear acceleration exposures of 0.5 seconds or more are no greater than the limits depicted in Appendix H, Figures H-1, H-2, H-3, H-4, and H-5. [V.CTS.216]

##### **4.3.10.2.2 Rotational Velocity Limits**

The crew exposure to rotational velocity shall be verified by analysis. The analysis shall use a validated simulation to identify and assess bounding acceleration cases including GN&C, vehicle, and environmental dispersions. The verification shall be considered successful when the analysis indicates that rotational velocities are no greater than the limits in those depicted in Figure 3.10.1.2-1. [V.CTS.217]

##### **4.3.10.2.3 Sustained Cross-Coupled Rotational Acceleration**

The crew exposure to sustained cross-coupled rotational acceleration shall be verified by analysis. The analysis shall use a validated simulation to identify and assess bounding acceleration cases including GN&C, vehicle, and environmental dispersions. The verification shall be considered successful when the analysis indicates that any product of two unique body attitude rates in yaw, pitch, or roll is no greater than 2 rad/s<sup>2</sup>. [V.CTS.218]

##### **4.3.10.2.4 RESERVED**

##### **4.3.10.2.5 Acceleration Rate of Change**

The crew exposure to jerk during sustained events shall be verified by analysis. The analysis shall use a validated simulation to identify and assess bounding acceleration cases including GN&C, vehicle, and environmental dispersions. The verification shall be considered successful when the analysis indicates that the simulated jerk is no greater than 500 g/s during any non-impact phase of flight. [V.CTS.220]

##### **4.3.10.2.6 Health Limits for Vibration during Dynamic Phases of Flight**

The dynamic phases of flight vibration exposure health limit shall be verified by analysis. The analysis shall consist of a simulation of the vibration levels at the crew seat (couch), assuming that the couch is a relatively rigid structure. The analysis shall consider all possible sources of vibration during each phase of flight. The weighted acceleration shall be calculated in accordance with ISO 2631-1:1997 using the frequency weighting  $W_d$  for the X and Y directions,  $W_k$  for the Z direction, and a multiplying factor  $k=1.4$  in the X and Y directions and  $k=1$  in the Z direction (ISO 2631-1:1997, Table 3 and Section 7.2). The verification shall be successful when for each phase of flight the predicted levels are below the requirements for the specified durations. [V.CTS.221]

#### **4.3.10.3 Dynamic Flight Occupant Protection**

### 4.3.10.3.1 Brinkley Dynamic Response Model

The crew exposure to impact acceleration shall be verified by analysis and test. The analysis shall be used to determine the dynamic conditions during abort and landing, in which the crew are most-susceptible to injury. Analysis shall determine the vehicle acceleration conditions for the at-risk abort and landing scenarios. Tests shall provide transient acceleration data as measured at the seat occupant for the identified scenarios and conditions. Additional analysis shall calculate the injury risk criterion,  $\beta$ , for all Brinkley criteria based on test data for all identified scenarios. Test and analysis shall also provide evidence that relevant criteria are met that validate the use of the Brinkley Dynamic Response model limits shown in Table 4.3.10.3.1-1 per NASA TM-2013-217380. Tests shall also be performed to show that a flight representative system prevents injury to the occupant(s) utilizing representative vehicle systems and anthropomorphic test dummies (ATD). Reference Table 4.3.10.3.1-2 and NASA TM-2013-217380) for relevant Injury Assessment Reference Values (IARV) Limits. The verification shall be considered successful when the analyses and tests indicate that the beta index for all Brinkley criteria is 1.0 or less during each scenario and the design meets the limits shown in Table 4.3.10.3.1-2 and NASA TM-2013-217380. [V.CTS.224]

**Table 4.3.10.3.1-1: Dynamic Response Limits**

DR Level	X		Y		Z	
	Eyeballs out	Eyeballs in	Eyeballs left	Eyeballs right	Eyeballs up	Eyeballs down
	$DR_x < 0$	$DR_x > 0$	$DR_y < 0$	$DR_y > 0$	$DR_z < 0$	$DR_z > 0$
Low (Deconditioned)	-28	35	-11.3	11.3	-11.5	13.0
Low (Non-Deconditioned) <sup>@</sup>	-28	35	-15	15	-13.4	15.2
Medium (Deconditioned)	-35	40	-15	15	-14.1	15.4
Medium (Non-Deconditioned) <sup>@</sup>	-35	40	-20	20	-16.5	18.0
High (Deconditioned)	-46	46	-22.5	22.50	-17.5	19.5

High (Non- Deconditioned) <sup>@</sup>	-46	46	-30	30	-20.4	22.8
--	-----	----	-----	----	-------	------

The table values assume lateral supports are used (limiting side body movement).  
<sup>@</sup> Use for healthy, non-deconditioned crew (e.g., launch abort cases)

**Table 4.3.10.3.1-2 Injury Assessment Reference Values (IARV) Limits**

ATD Metric	ATD Size <sup>1</sup>	Non-Deconditioned		Deconditioned	
		Nominal	Off-Nominal	Nominal	Off-Nominal
HIC 15	5 <sup>th</sup> Female	375	525	375	525
	95 <sup>th</sup> Male	325	450	325	450
Head Rotational Acceleration [rad/sec <sup>2</sup> ]	5 <sup>th</sup> Female	2,500	4,200	2,500	4,200
	95 <sup>th</sup> Male	2,100	3,600	2,100	3,600
N <sub>ij</sub>	5 <sup>th</sup> Female	0.5	0.5	0.4	0.4
	95 <sup>th</sup> Male	0.5	0.5	0.4	0.4
Peak Neck Axial Force [N] <sup>2</sup>	5 <sup>th</sup> Female	890 – 1,840		765 – 1,580	
	95 <sup>th</sup> Male	2,000 – 3,390		1,720 – 2,910	
Peak Neck Axial Compression Force [N] <sup>2</sup>	5 <sup>th</sup> Female	890 – 2,310		765 – 1,990	
	95 <sup>th</sup> Male	2,000 – 4,360		1,720 – 3,750	
Flail	5 <sup>th</sup> Female	Pass			
	95 <sup>th</sup> Male	Pass			
Peak Lumbar Axial Compression [N] <sup>3</sup>	5 <sup>th</sup> Female	3,500	4,200	3,000	3,600
	95 <sup>th</sup> Male	6,600	7,800	5,700	6,700

<sup>1</sup>The following ATDs shall be used to evaluate the metrics in Table 4.3.10.3.1-2:

- 5<sup>th</sup> percentile female automotive Hybrid III
- 95<sup>th</sup> percentile male automotive Hybrid III

<sup>2</sup>Values in table are evaluated at varying time durations as specified in NASA TM-2013-217380.

<sup>3</sup>Required only if amplification rule is not met by the design, as specified in NASA TM-2013-217380. Requires the use of a straight spine modification to the 95<sup>th</sup> percentile Male ATD

### 4.3.10.3.2 Limitation of Crew Injury

The prevention of injury to crewmembers during dynamic phases of flight shall be verified by inspection, test, and analysis. Analysis shall identify applicable landing conditions and, using models, assess injury risk during dynamic phases of flight. Inspection shall be a review of the design, including hazard analysis and crew survival analysis results, drawings, graphical models, and/or physical mockups, to ensure that load paths are not concentrated, that restraints prevent limb flail, and that a survivable volume is preserved without structural impingement on crew during certified load cases, nominal and off-nominal. Tests shall also be performed to show that a flight representative system prevents injury to the occupant(s) utilizing representative vehicle systems and ATDs. The verification shall be considered successful when test, inspection and analyses indicate that the system prevents injury to crewmembers due to blunt force trauma, point loads, flail, and injurious forces to the body including the head and neck during dynamic phases of flight. [V.CTS.225]

### 4.3.10.3.3 RESERVED

## 4.3.10.4 Crew Interface Requirements

### 4.3.10.4.1 Crew Interface Usability

Crew satisfaction with spacecraft interfaces shall be verified by analysis and test. A task analysis shall be performed to identify human activities required for nominal and off-nominal operation in the applicable mission phases and environments. The test shall consist of a usability evaluation based on standard best practices (e.g., Jakob Nielsen's "Usability Engineering," 1993). A minimum of 20 participants shall perform onboard tasks, identified through task analysis, in a flight representative vehicle. At the conclusion of the usability test, and prior to any debrief or administering of post-evaluation questionnaires, the participants shall complete the System Usability Scale (SUS) (Brooke, 1996) found in Appendix L, Figure L.3-1. The overall system usability shall be calculated as the scale position minus 1 for questions 1, 3, 5, 7, and 9, and 5 minus the scale position for questions, 2, 4, 6, 8, and 10. The overall satisfaction score shall be obtained by multiplying the sum of the adjusted scores by 2.5. The verification shall be considered successful when the test shows that for representative tasks identified in the analysis, the lower limit of the 95% confidence interval of the SUS average score is 85 or above.  
[V.CTS.138]

#### **4.3.10.4.2 Crew Interface Workload**

The spacecraft workload rating for nominal and off-nominal crew tasks shall be verified by analysis and test. A task analysis shall be performed to identify human activities required for nominal and off-nominal operation in the applicable mission phases and environments. The test shall consist of an evaluation by at least eight trained participants in a flight representative vehicle in the flight configuration performing each of the listed crew tasks and providing workload ratings on the Bedford Workload Scale. Tasks shall be grouped so that related tasks will be performed concurrently and sequentially as expected during actual in-flight operations. The evaluation period for each task shall span the duration of the task with participants providing their ratings at the end of this period. During workload evaluation tests, participants shall maintain performance error rates and completion times commensurate with the performance requirements of the particular task. For nominal tasks, the verification shall be considered successful when the test results show that for representative nominal tasks identified in the analysis, at least 6 of the 8 ratings are no greater than a rating of 3 on the Bedford workload scale, while up to 2 of the 8 ratings may exceed the rating of 3 (allowing workload ratings of 4, 5, or 6 on the Bedford workload scale). For any ratings of 4, 5, or 6, the verification shall be considered successful only if consensus is reached by all of the participants indicating that the workload is acceptable. For off-nominal tasks, including contingency, the verification shall be considered successful when the test results show that for representative off-nominal tasks identified in the analysis, all of the subjects provide a rating of 6 or less on the Bedford scale.  
[V.CTS.139]

#### **4.3.10.4.3 Operability of Controls**

The operability of controls by a crewmember in their flight configuration shall be verified by analysis and demonstration. A task analysis shall be performed to identify human activities required for nominal and off-nominal operation in the applicable mission phases and environments. A demonstration of representative tasks shall be performed in a flight representative vehicle with crewmembers in their flight configuration executing tasks requiring crew control. The verification shall be considered successful when the demonstration shows crewmembers in their flight configuration can successfully complete representative tasks using the controls. [V.CTS.340]

#### **4.3.10.4.4 Design Induced Crew Errors**

Design-induced crew error rates shall be verified by analysis and test. A task analysis shall be performed to identify human activities required for nominal and off-nominal operation in the applicable mission phases and environments. The task analysis shall be used to identify potential human errors that can be encountered. The test shall consist of usability evaluations based on standard best practices (for example, Jakob Nielsen's "Usability Engineering," 1993). During the usability evaluation, a minimum of 20 participants (Faulkner, L., 2003) shall perform a set of onboard tasks in a flight representative vehicle. Usability evaluations should also include assessment of efficiency and satisfaction through collection of data, such as completion times and ratings on subjective questionnaires for use in differentiation of design-induced errors from errors related to human reliability. For purposes of this test, a task requiring evaluation will be defined as an activity driven by a procedure. The procedure consists of a series of task steps, where a task step will be defined as a single instruction to the crewmember, as is typical of current space flight procedures. Participants shall maintain task completion times commensurate with the performance requirements of the particular task. The percentage of erroneous task steps for each participant shall be calculated by dividing the number of erroneous task steps and incomplete task steps by the total number of task steps and multiplying the result by 100. The percentage of participants committing each erroneous task step shall be calculated by dividing the number of participants committing each erroneous task step by the total number of participants and multiplying the result by 100. The verification shall be considered successful when the results of the analysis and test show that the percentage of erroneous task steps per participant is no greater than 5% and the percentage of participants who committed each erroneous task step is no greater than 10%. [V.CTS.335]

#### **4.3.10.4.5 Emergency Annunciations**

The spacecraft's visual and auditory annunciations of emergency, warning, and caution events shall be verified by analysis, test and demonstration. The analysis shall determine the alarm categories triggered by each hazardous event defined in CCT-REQ-1130 section 4.3.2.4.1. The test shall determine if visual and auditory annunciators conform to section 9.4.4.3 of SSP 50005, International Space Station Flight Crew Integration Standard. The demonstration shall be performed using flight representative software and hardware and each emergency, warning, and caution events. The verification shall be considered successful when the analysis, test, and demonstration show that each emergency, warning, and caution event triggers the correct visual and auditory annunciations according to section 9.4.4.3 of SSP 50005, International Space Station Flight Crew Integration Standard. [V.CTS.142]

#### **4.3.10.4.6 Annunciator Test**

The spacecraft notification of system failure of visual and auditory annunciators shall be verified by demonstration. A demonstration shall be performed with flight representative software and hardware. The demonstration shall initiate a test of the visual and auditory annunciators and observe the response. A demonstration shall then simulate failures of the visual and auditory annunciators, and then initiate a test of the visual and auditory annunciators and observe the response. The verification shall be considered successful when the demonstrations show that the system provides a response consistent with the state of the annunciators. [V.CTS.143]

#### **4.3.10.4.7 Protect for Inadvertent Operation**

Inadvertent operation shall be verified by analysis, inspection and demonstration. A hazard analysis shall identify controls whose inadvertent operation would lead to a catastrophic event or

an abort. The inspection and the demonstration shall be performed using flight-configuration hardware and software. The demonstration shall simulate inadvertent inputs using flight representative hardware and software. The verification shall be considered successful when the analysis, inspection and demonstration show that controls that have been identified through the hazard analysis as requiring protection are prevented from inadvertent operation. [V.CTS.149]

#### **4.3.10.4.8 Annunciator Intelligibility**

Auditory speech annunciations and communications intelligibility shall be verified by analysis and test. The analysis shall derive the nominal background noise spectrum for testing for each mission phase. The test shall be made between the flight representative vehicle in the flight configuration and the CVCC through a flight representative communications network using the methodology given in ANSI S3.2-2009. The test shall apply to the annunciators that are in-use during each mission phase. The verification shall be considered successful when the test and analysis indicate a 90% word identification level at the ear of the listener throughout the habitable volume. [V.CTS.119]

#### **4.3.10.5 Acoustics**

##### **4.3.10.5.1 Acoustics Limits for Launch, Entry, and Abort**

###### **4.3.10.5.1.1 24-Hour Noise Exposure Limit**

The CTS's noise dose limits at the crewmember's ear for launch and entry shall be verified by test and analysis. The noise level as a function of time for the launch, entry, and ascent abort measured at the crewmember's ears shall be determined by analysis. The analysis shall estimate the noise level as a function of time at the crewmember's ear by combining significant noise sources from estimates of Launch vehicle noise and external flow boundary layer noise and including acoustic insertion losses of acoustic isolation and protective devices. The CTS noise sources shall be determined by test. Acoustic insertion losses of the pressure shell and other materials shall be determined by test. The effectiveness of hearing protection, headsets, and helmets shall be determined by test. Noise levels for the balance of the 24-hour calculation period shall be assumed to be 65 dBA. The verification shall be considered successful when tests and analysis indicate that the 24-hour noise dose associated with launch, entry, and ascent abort predicted at the crewmember's ears is 100% or less. [V.CTS.228]

###### **4.3.10.5.1.2 Launch/Entry SPL Limit**

The CTS's hazardous noise limit for launch, entry, and abort shall be verified by test and analysis. The maximum noise level measured at the crewmember's ears shall be determined by analysis. The analysis shall estimate the noise level as a function of time at the crewmember's ear by combining significant noise sources from estimates of Launch Vehicle and external flow boundary layer noise and including acoustic insertion losses of acoustic isolation and protective devices. The CTS noise sources shall be determined by test. Acoustic insertion losses of the pressure shell and other materials shall be determined by test. The effectiveness of hearing protection, headsets, and helmets shall be determined by test. The verification shall be considered successful when the tests and analysis indicate that the maximum level predicted at the crewmember's ears is 105 dBA or less during launch and entry, and 115 dBA or less during ascent abort. [V.CTS.229]

###### **4.3.10.5.1.3 Impulse Noise Limit - Ear**



The CTS impulse noise limit for launch and entry shall be verified by test and analysis. The impulse noise level measured at the crewmember's ears shall be determined by flight test. The test and analysis shall consist of estimating the impulse noise level at the crewmember's ear by combining significant noise sources and including acoustic insertion losses of acoustic isolation and protective devices. The ignition noise should be determined by test. Acoustic insertion losses of the pressure shell and other materials shall be determined by test. The effectiveness of hearing protection, headsets, and helmets shall be determined by test. Peak-hold sound pressure level measurements shall be made using a Type 1 sound level meter. The frequency response of the sound level meter shall extend to at least 6 Hz at its lower limit. Formal verification is not required for equipment with impulse noises that have peak overall SPLs of less than 110 dB. The verification shall be considered successful when the test and analysis results indicate that the peak overall sound pressure level predicted at the crewmember's ears is less than 140 dB. [V.CTS.230]

#### **4.3.10.5.1.4 Infrasonic Noise Limit**

The CTS's infrasonic noise limit shall be verified by test and analysis. The maximum noise level measured at the crewmember's ears shall be determined by analysis. The analysis shall estimate the maximum sound level at the crewmember's ear by combining significant noise sources from estimates of launch vehicle noise and external flow boundary layer noise, and including acoustic test of integrated space vehicle noise sources. Acoustic insertion losses of the pressure shell and other materials shall be determined by test. The effectiveness of hearing protection, headsets, and helmets is not allowed for this verification. Sound pressure measurements shall be made over a frequency range from 1 to 20 Hz, using a Type 1 integrating-averaging sound level meter at expected work station head locations. The infrasonic noise level shall be measured via a Leq (slow time weighting). The verification shall be considered successful when the test and analysis indicate that the unweighted overall sound pressure level is 150 dB or less at each expected work station head-location. [V.CTS.231]

#### **4.3.10.5.2 Acoustic Limits for the Orbit and Post-Landing Phases**

##### **4.3.10.5.2.1 Noise level for Communication**

The spacecraft environment for intercabin communication shall be verified by test. The test shall be conducted in the flight-vehicle in the loudest nominal condition with all cabin equipment operating consistent with mission phase. Integrated portable equipment, stowage, vehicle installations, and closeouts shall be installed for the test. Noise produced by active payloads and Government Furnished Equipment shall be included by test or analysis. Impulse noise, alarms, and voice communications shall be excluded from the test. Hardware shall be operated across the expected range of operational settings including settings corresponding to the expected highest noise levels. Measurements shall be made at expected work and sleep station head locations, the center of the pressurized volume, and throughout the habitable volume to determine a spatial average. Measurement locations shall be no closer than 30 cm from each other and no closer than 8 cm from any surface. The spatial average shall be based on incoherent sound power addition (i.e., average of pressure-squared values). The spatial average shall include measurements from the locations above and a sufficient number of additional locations to achieve a  $\pm 2$  dB 90% confidence interval within each octave band from 250 Hz to 16 kHz. The verification shall be considered successful when field testing indicates that:

- a. the spatially-averaged SPLs (average of pressure-squared values) throughout the habitable volume do not exceed the NC-52 levels given in Figure 3.10.5.2.1-1 and Table 3.10.5.2.1-1
- b. no octave band sound pressure level measured at any location or at the maximum level location (i.e., the location of the maximum A-weighted overall sound pressure level found with a handheld sound level meter) within the entire habitable volume is more than 4 dB above the NC-52 levels specified in Figure 3.10.5.2.1-1 and Table 3.10.5.2.1-1, and
- c. the intent of requirements Q.1.2, Q.1.5, and Q.6.1 are satisfied. [V.CTS.342]

#### 4.3.10.6 Radiation

##### 4.3.10.6.1 Ionizing Radiation

##### 4.3.10.6.2 Radiation Design

###### 4.3.10.6.2.1 Radiation Protection

The CTS's crewmember radiation exposure shall be verified by analysis. The analysis shall be performed through the use of a model with the following components:

Design Environment: SSP 30512, *Space Station Ionizing Radiation Design Environment*.

Transport Code: Latest transport code (e.g., 2005 HZETRN).

Vehicle Geometry: Standard CAD model of the vehicle structure, hardware, stowage, and commercial equipment. This includes materials specification sufficient to derive chemical composition and bulk density for each instance/part in the design. The vehicle, as analyzed, shall be representative of a standard configuration for vehicle components, equipment, and stowage items, as well as a minimum crew complement placed within the habitable volume.

Shield Evaluation/Mass Distribution Evaluation: Barrier Thickness Evaluator (BTE) code.

Human Geometry: 50th percentile female model.

Effective dose shall be calculated as a quantity,

$$E = \sum_T w_T H_T$$

Where, the equivalent dose,  $H_T$ , is defined as

$$H_T = Q(L)D_{T,R}$$

$D_{T,R}$  is the dose averaged over a specific organ or tissue (T) due to radiation (R).

The tissue weighting factor  $w_T$  is given in Table 4.3,  $w_T$  for Different Tissues and Organs, in National Council on Radiation Protection and Measurements (NCRP) Report Number 132.

$Q(L)$  is the radiation quality factor as a function of Linear Energy Transfer (LET) in water as specified in NCRP Report 132, Table 4.2 "Quality Factor-LET Relationships." When performing this analysis, the assessment shall also include the use of radioactive isotopes and radiation producing equipment onboard the spacecraft. The verification shall be considered successful when the analysis shows that the protection from radiation exposure to ensure that the effective dose (tissue average) to any crewmember within the vehicle is consistent with the ALARA principle. [V.CTS.239]

##### 4.3.10.6.3 Non-Ionizing Radiation

#### **4.3.10.6.3.1 RF Non-Ionizing Radiation Exposure Limits**

The CTS's crew exposure to radio-frequency electromagnetic fields shall be verified by test and analysis. A hazard analysis shall be performed in the design phase to ensure that all potential radiation sources have been identified according to the defined operational RF environment. A model/analysis shall be generated that comprises the defined RF environment over all flight phases, including additive and synergistic effects. The model shall be used to predict RF exposure levels in crew accessible areas, both internal and external to the spacecraft. During the physical certification process, inter-system electromagnetic compatibility testing will be performed at the vehicle level, in which the vehicle itself is radiated with the defined RF environment enveloping all flight phases. As part of that measurement process, instrumentation will be located inside the vehicle to sample the electromagnetic field that penetrates the vehicle. This data will then be made available for comparison to the model/analysis results. The verification shall be considered successful when the analysis and test results demonstrate that crew exposures are within the limits specified Figure 3.10.6.3.1-1. [V.CTS.241]

#### **4.3.10.6.3.2 Laser Exposure Limits**

The verification for laser exposure limits shall be completed by any one of the following methods:

- a. Inspection of spacecraft equipment documentation. Verification shall be considered successful if the documentation shows there are no lasers on the spacecraft.
- b. Ocular and dermal exposure from laser systems shall be verified by analysis. The analysis shall be performed as defined by ANSI Z136.1-2007, American National Standard for Safe Use of Lasers. A necessary input for the analysis is the measurement procedures used for the classification of the laser, as specified in ANSI Z136.4, 2005, American National Standard for Recommend Practice for Laser Safety Measurements for Hazard Evaluation.

The verification shall be considered successful when the analysis shows that ocular exposure is within the limits of Maximum Permissible Exposure (MPE) values for eye and skin listed in ANSI Z136.1-2007 considering all credible exposure scenarios and without protective equipment. [V.CTS.242]

#### **4.3.10.6.4 Incoherent Electromagnetic Radiation**

##### **4.3.10.6.4.1 Retinal Thermal Injury from Visible and Near Infrared Source**

Crewmember exposure to visible and near infrared sources limits shall be verified by test and analysis. The test shall measure the transmittance of all transparent and translucent apertures and radiance of artificial sources from at least 385-1,400 nm in 1-nm increments. Transmittance measurements may be taken in a flight-representative vehicle using witness samples in the flight configuration if the witness samples are large enough to capture the enhanced transmittance realized from multi-pane reflections; otherwise, transmittance measurements shall be performed on flight articles. Spectral radiance measurements of artificial sources shall be done by type and lot. The analysis shall include calculation of the limits indicated in the requirement using the transmittance and radiance values obtained during the test. The verification shall be considered successful when the analysis shows that the limits calculated from the equations in this requirement are maintained within the applicable spectrum (385-1,400 nm). [V.CTS.244]

##### **4.3.10.6.4.2 Visible Radiation Limits**

Crewmember exposure limits shall be verified by test and analysis. The test shall measure the transmittance of all transparent and translucent apertures and radiance of artificial sources from at least 305-700 nm in 1-nm increments. Transmittance measurements may be taken in a flight-representative vehicle using witness samples in the flight configuration if the witness samples are large enough to capture the enhanced transmittance realized from multi-pane reflections; otherwise, transmittance measurements shall be performed on flight articles. Spectral radiance measurements of artificial sources shall be done by type and lot. The analysis shall include calculation of the limits indicated in the requirement using the transmittance and radiance values obtained during the test. The verification shall be considered successful when the analysis shows that the limits calculated from the equations in this requirement are maintained within the applicable spectrum (305-700 nm). [V.CTS.245]

#### **4.3.10.6.4.3 Thermal Injury from Infrared Radiation**

Crewmember exposure limits shall be verified by test and analysis. The test shall measure the transmittance of all transparent and translucent apertures and radiance of artificial sources from at least 770-3,000 nm in 1-nm increments. Transmittance measurements may be taken in a flight-representative vehicle using witness samples in the flight configuration if the witness samples are large enough to capture the enhanced transmittance realized from multi-pane reflections; otherwise, transmittance measurements shall be performed on flight articles. Spectral radiance measurements of artificial sources shall be done by type and lot. The analysis shall include calculation of the limits indicated in the requirement using the transmittance and radiance values obtained during the test. The verification shall be considered successful when the analysis shows that the limits calculated from the equations in this requirement are maintained within the applicable spectrum (770-3,000 nm). [V.CTS.246]

#### **4.3.10.6.4.4 Ultraviolet (UV) Exposure for Unprotected Eye or Skin**

Crewmember exposure limits shall be verified by test and analysis. The test shall measure the transmittance of all transparent and translucent apertures and radiance of artificial sources from at least 180-400 nm in 1-nm increments. Transmittance measurements may be taken in a flight-representative vehicle using witness samples in the flight configuration if the witness samples are large enough to capture the enhanced transmittance realized from multi-pane reflections; otherwise, transmittance measurements shall be performed on flight articles. Spectral radiance measurements of artificial sources shall be done by type and lot. The analysis shall include calculation of the limits indicated in the requirement using the transmittance and radiance values obtained during the test. The verification shall be considered successful when the analysis shows that the limits calculated from the equations in this requirement are maintained within the applicable spectrum (180-400 nm). [V.CTS.247]

#### **4.3.10.7 RESERVED**

#### **4.3.10.8 RESERVED**

#### **4.3.10.9 RESERVED**

#### **4.3.10.10 Operational Limitations**

##### **4.3.10.10.1 Crew Awake Period**

The CTS's provision of a crew-awake period of 16 hours or less on any free flight day except landing day shall be verified by inspection. The inspection shall consist of a review of the

nominal mission flight plan (including a task by task review of activity durations) from launch day until landing for those days where the crew is not in the ISS for full days. The verification shall be successful when the inspection shows the nominal mission flight plan schedules 16 hours or less of crew-awake time, including 1 hour of post-sleep and 1 hour of pre-sleep, 30 continuous minutes per meal for consumption of 3 meals per day, additional continuous time for meal preparation, crew sleep scheduled no earlier than 3 hours after launch, and no nominally planned docking or undocking/separation operations prior to post-sleep and breakfast on any flight day. [V.CTS.108]

#### **4.3.10.10.2 Landing Day Crew Awake Period**

The CTS's provision of a crew-awake period of 18 hours or less on landing day shall be verified by inspection. The inspection shall consist of a review of the nominal mission flight plan (including a task by task review of activity durations) for landing day. The verification shall be successful when the inspection shows the nominal mission flight plan schedules 18 hours or less of crew-awake time including 6 hours post-landing egress, 1 hour post-sleep, 30 continuous minutes per meal for consumption, with additional continuous time for meal preparation, and no nominally planned deorbit operations prior to post-sleep and breakfast on landing day. [V.CTS.347]

#### **4.3.10.10.3 Crew Sleep Period**

The CTS's provision of a crew minimum of 8 continuous hours of sleep for all crew at the same time shall be verified by inspection. The inspection shall consist of a review of the nominal mission flight plan (including a task by task review of activity durations) from flight day 1 (FD1) until landing day for those mission days where the spacecraft is not mated to ISS for the full crew day. The verification shall be successful when the inspection shows the nominal mission flight plan schedules a minimum of 8 continuous hours of sleep for all crew during the same sleep period on any free flight day. [V.CTS.320]

#### **4.3.10.10.4 Crew Limits in Launch Orientation**

The limitation of 5 hours in the launch orientation with crew on back shall be verified by inspection. The inspection shall consist of a review of the timelines and crew configurations from vehicle ingress until launch. The verification shall be successful when the inspection shows the timelines and configurations of the crewmembers has the crew on their backs with feet elevated for 5 hours or less in the launch orientation in the pre-launch phase (excluding subsequent safing and egress time for a launch scrub). [V.CTS.348]

### **4.3.10.11 Internal Atmosphere**

#### **4.3.10.11.1 General**

##### **4.3.10.11.1.1 Habitability Limits**

- a. Cabin Pressure - The spacecraft maintenance of pressure shall be verified by analysis and test. The analysis shall show that the pressure control system can maintain the pressure within the specified range and that adequate consumables are available to support the maximum duration mission. The test shall show that the integrated system can flow oxygen and nitrogen to maintain the cabin pressure. The verification shall be considered successful when the test and analysis data show that the vehicle can maintain pressure of the internal

atmosphere within the limits throughout all flight phases except during quiescent docked operations.

- b. Cabin ppO<sub>2</sub> - The spacecraft oxygen partial pressure levels in the cabin shall be verified by analysis and test. The analysis shall show that the pressure control system can maintain the oxygen partial pressure within the specified range and that adequate consumables are available to support the maximum duration mission. The test shall show that the integrated system can flow oxygen to maintain the cabin partial pressure of oxygen while oxygen is being removed by a metabolic simulator in a flight configuration with a flight representative ventilation system. The test shall be performed until a steady state level is achieved. The verification shall be considered successful when the test and analysis data show that the vehicle can maintain the partial pressure of oxygen within the limits throughout all flight phases except during quiescent docked operations.
- c. Cabin Depress/Repress Rates - The spacecraft rate of total pressure change shall be verified by analysis. The analysis shall include a review of the vehicle design and operations and an evaluation of the worst-case scenario for pressure change during nominal operations. The verification shall be considered successful when the analysis shows that the spacecraft will not exceed the pressure change described in the requirement.
- d. Cabin ppCO<sub>2</sub> - Spacecraft control of the partial pressure of carbon dioxide shall be verified by analysis and test. An analysis, in the form of a simulation, shall evaluate the vehicle's ability to maintain the cabin carbon dioxide levels within the specified range under the metabolic loads specified in 3.10.11.2.4 for the maximum duration mission. The test shall evaluate flight representative cabin ventilation hardware and carbon dioxide removal hardware in the flight configuration under simulated metabolic load until a steady state level is achieved. The verification shall be considered successful when the test and analysis shows that the spacecraft can maintain the carbon dioxide levels to the limits in the requirement throughout all flight phases except during quiescent docked operations.
- e. Cabin Temperature - Spacecraft atmospheric temperature control within the specified range shall be verified by analysis. An analysis, in the form of a simulation, shall evaluate the vehicle's ability to regulate the vehicle cabin temperature throughout the flight envelope under the metabolic loads specified in 3.10.11.2.4. The verification shall be considered successful when the analysis shows that the temperature can be maintained within the specified range during all nominal unsuited flight operations, excluding quiescent docked operations and post-landing.
- f. Cabin Relative Humidity - Spacecraft relative humidity control shall be verified by analysis. An analysis, in the form of a simulation, shall evaluate the vehicle's ability to regulate the vehicle relative humidity throughout the flight envelope under the metabolic loads specified in 3.10.11.2.4. The verification shall be considered successful when the analysis shows that the spacecraft can maintain the average relative humidity levels within the specified range during all nominal unsuited flight operations, excluding quiescent docked operations and post-landing.
- g. Cabin Velocities for Mixing - The spacecraft capability to maintain a ventilation rate within the spacecraft shall be verified by analysis. The analysis shall include a fluid dynamics model of the interior habitable volume and shall identify potential areas within the habitable volume with no air movement. The analysis shall consider the ventilation rate only at a single,

nominal setting for all fan speeds and diffusers. The verification shall be considered successful when the analysis establishes that two-thirds (66.7%) of the atmosphere velocities are between 4.57 m/min (15 ft/min) and 36.58 m/min (120 ft/min), no more than 5% of the velocities are less than 2.13 m/min (7 ft/min), and no more than 1% of the velocities are in excess of 60.96 m/min (200 ft/min) at a distance measured more than 0.15 m [6 inches]) from the vehicle walls during all mission phases, except during suited operations, toxic cabin events, or quiescent docked operations. [V.CTS.346]

#### **4.3.10.11.1.2 Cabin Pressure Maintenance during Leak**

The verification to support a cabin leak shall be accomplished by analysis. A consumables analysis shall show that adequate quantities of oxygen and nitrogen are available to maintain a cabin pressure of 55.2 kPa (8 psia) or greater with an equivalent cabin hole diameter of 0.64 cm (0.25 in) for the time required to execute an EDL. The analysis shall assume a Coefficient of Discharge greater than or equal to 0.72. A performance analysis shall show that the pressure control system can maintain the cabin pressure to greater than or equal to 55.2 kPa (8.0 psia) while supporting an equivalent cabin hole diameter of 0.64 cm (0.25 in). An operability analysis shall be performed to determine the systems required to execute a successful EDL. An analysis shall be performed to determine the required cooling for critical EDL systems in the reduced pressure environment. The verification shall be considered successful when the integrated analyses show that adequate oxygen and nitrogen consumables are available and supplied to the cabin within limits as defined in 3.10.11.2.2 and 3.10.11.2.3, while maintaining the cabin pressure above 55.2 kPa (8.0 psia), and that critical EDL systems will operate at 55.2 kPa (8.0 psia) with an equivalent cabin hole diameter of 0.64 cm (0.25 in). [V.CTS.153]

#### **4.3.10.11.1.3 Return Contaminated Atmosphere within Limits**

The ability of the spacecraft to return the cabin atmosphere to the limits defined in Tables 3.10.11.1.1-1 and 3.10.11.1.3-1 following the contamination of the cabin atmosphere when the hatch is closed, shall be verified by analysis. An analysis of likely fire and contamination scenarios, as derived from a hazard analysis, shall determine the constituents and their concentration at the beginning of this operation. An analysis, in the form of a simulation, shall evaluate the vehicle's ability to revitalize the atmosphere under the constituent load developed in the operational analysis. The verification shall be considered successful when the analysis shows the cabin contamination level can be lowered below the Table 3.10.11.1.3-1 limits and the cabin atmosphere can be returned to limits defined in Table 3.10.11.1.1-1. [V.CTS.152]

#### **4.3.10.11.1.4 Protect for Atmospheric Contingency**

The spacecraft's ability to provide atmospheric contingency protection shall be verified by analysis and inspection. The analysis shall determine the quantity of consumables required for each of the following events:

- a. Contaminated atmosphere event cleanup, which includes gas for emergency breathing apparatus, if applicable, and cabin purge of the entire pressurized volume (equivalent to a depress/repress of the entire pressurized volume) to return the atmosphere to within SMAC limits.
- b. Unrecoverable cabin leak, which includes gas to maintain cabin at or above 55.2 kPa (8.0 psi).

The verification shall be considered successful when inspection of the consumables budget shows the required quantities of consumables for the worst case of the two pressure events, in addition to those required for nominal and contingency operations defined in Section 3.4. [V.CTS.154]

#### **4.3.10.11.2 Detailed Pressurized Crew Cabin Requirements**

##### **4.3.10.11.2.1 Crew Atmospheric Control**

The spacecraft cabin temperature and ventilation control by flight crew shall be verified by analysis and demonstration. The analysis shall evaluate the life support system and controls. The analysis shall determine the temperature and ventilation control authority throughout the flight envelope. The demonstration shall adjust the temperature and ventilation set points on flight representative vehicles. The verification shall be considered successful when the analysis shows that the spacecraft can support multiple set points throughout all flight phases except during quiescent docked operations and the demonstration shows that the system responds to a change in set point. [V.CTS.157]

##### **4.3.10.11.2.2 O<sub>2</sub> Limit**

The maintenance of the oxygen concentration to 24.1% by volume in the spacecraft cabin shall be verified by analysis. The analysis shall show the spacecraft can control oxygen concentration to 24.1% by volume or less, from a nominal cabin pressure per Table 3.10.11.1.1-1 to a cabin pressure of 70kPa (10.2psia). The analysis shall account for system uncertainties such as cabin pressure and oxygen monitoring errors. The verification shall be considered successful when the analysis shows the system can control the oxygen concentration to 24.1% by volume or less, from a nominal cabin pressure per Table 3.10.11.1.1-1 to a cabin pressure of 70kPa (10.2psia). [V.CTS.166]

##### **4.3.10.11.2.3 O<sub>2</sub> Limit during Depressurization**

The maintenance of the oxygen levels in the spacecraft cabin shall be verified by analysis. The analysis shall show the spacecraft can control oxygen levels to greater than 17 kPa (2.4 psia) partial pressure and less than 30% oxygen concentration while at reduced pressures from 70 to 55 kPa (10.2 to 8.0 psia). The analysis shall account for system uncertainties such as cabin pressure and oxygen monitoring errors. The verification shall be considered successful when the analysis shows the system can control oxygen levels to greater than 17 kPa (2.4 psia) partial pressure and less than 30% oxygen concentration while at reduced pressures. [V.CTS.167]

##### **4.3.10.11.2.4 Accommodate Metabolic Loads**

The spacecraft's accommodation of metabolic loads shall be verified by analysis. The analysis shall identify the tasks, flight configurations, and associated metabolic rates of each crewmember. The analysis shall evaluate atmospheric ppO<sub>2</sub>, ppCO<sub>2</sub>, temperature, and relative humidity for the nominal phases while unsuited. The verification shall be considered successful when the analysis shows that the spacecraft is capable of accommodating the expected metabolic loads imposed by the crewmember, per Appendix F, "Metabolic Loads," while maintaining the required atmospheric conditions in Table 3.10.11.1.1. [V.CTS.312]

#### **4.3.10.12 Contamination**

##### **4.3.10.12.1 Measure Toxic Combustion Products**



The ability of the CTS to measure and display the specified atmospheric gas concentrations in real-time in the required ranges shall be verified by analysis and test. An analysis shall be performed to determine the measurement response time required to support operational decisions. The test shall evaluate the atmospheric monitoring instruments ability to measure the toxic product concentrations over the entire operating range to the accuracies specified in this requirement. The verification shall be considered successful when the test shows the measurement and display of atmospheric concentrations of the specified toxic combustion products over the specified ranges with the required accuracies in the time required to support operational decisions. [V.CTS.182]

#### 4.3.10.12.2 Use of Hazardous Chemicals

The CTS's use of Toxic Hazard Level 3 or lower chemicals in the habitable volume of the system shall be verified by analysis. The analysis shall include a review of the materials and chemicals selected for spacecraft construction and their use in the operation of the vehicle. The verification shall be considered successful when the analysis shows Toxic Hazard Level 3 or lower chemicals are the only chemicals used in the habitable volume of the vehicle and that no decomposition products will be a Toxicological Hazard Level 4 in accordance with JSC 26895, Guidelines for Assessing the Toxic Hazard of Spacecraft Chemicals and Test Materials. [V.CTS.183]

#### 4.3.10.12.3 Gas Pollutant Limits

The spacecraft's control of gaseous pollutants in the habitable volume shall be verified by analysis and test. The analysis shall evaluate the vehicle's active control of the concentration of individual trace chemical contaminants introduced into the cabin according to the load defined by Table 4.3.10.12.3-1. The test shall provide the data used to derive actual equipment off-gassing rates. The test conducted according to SSP 41172, Qualification and Acceptance Environmental Test Requirements shall be used to determine the integrated vehicle equipment off-gassing generation load. The off-gassing rate data derived from the test and data relating to system chemical sources supersede the equipment off-gassing and system generation rates of Table 4.3.10.12.3-1. The verification of gaseous pollutant accumulation in the habitable atmosphere to below 1.0 T unit during all mission phases shall be considered successful when the analysis shows the gaseous pollutant accumulation in the habitable volume meets 0.5 T units or less based on 7-day SMACs for the combined load of spacecraft system sources and metabolic loads (part a.) and when the analysis and test show the gaseous pollutant accumulation in the habitable volume meets 0.5 T units or less based on 7-day SMACs for off-gassing (part b.). [V.CTS.184]

**Table 4.3.10.12.3-1: Trace Chemical Containment Design Load**

CONTAMINANT	MAXIMUM CONCENTRATION (mg/m <sup>3</sup> ) <sup>a</sup>	GENERATION RATE		
		OFFGASSING (mg/d-kg) <sup>b</sup>	METABOLIC (mg/d-person)	SYSTEM (mg/d)
Methanol	90	$1.3 \times 10^{-3}$	0.9	0
Ethanol	2,000	$7.8 \times 10^{-3}$	4.3	0
n-butanol	80	$4.7 \times 10^{-3}$	0.5	0
Methanal (formaldehyde)	0.12	$4.4 \times 10^{-6}$	0.4	0
Ethanal (acetaldehyde)	4	$1.1 \times 10^{-4}$	0.6	0
Benzene	1.5	$2.5 \times 10^{-5}$	2.2	0
Methylbenzene (toluene)	15	$2 \times 10^{-3}$	0.6	0

Dimethylbenzenes (xylenes)	73	$3.7 \times 10^{-3}$	0.2	0
Dichloromethane	49	$2.2 \times 10^{-3}$	0.09	0
2-propanone (acetone)	52	$3.6 \times 10^{-3}$	19	0
Trimethylsilanol	4	$1.7 \times 10^{-4}$	0	0
Hexamethylcyclotrisiloxane	90	$1.7 \times 10^{-4}$	0	0
Ammonia	2	$8.5 \times 10^{-5}$	50	160 <sup>c</sup>
Carbon monoxide	63	$2 \times 10^{-3}$	18	0
a. 7-day Spacecraft Maximum Allowable Concentration from JSC 20584 dated November 2008.				
b. Offgassing rate is for the mass of internal, non-structural equipment.				
c. Ammonia generation by amine-containing system components, zero if no amine present.				

#### 4.3.10.12.4 Particulate Control

The limit of particulate in the internal atmosphere shall be verified by analysis. The analysis shall include a review of the vehicle cabin airflow and filtration design. The verification shall be considered successful when the analysis shows that the 24-hour average particulate concentration within the vehicle meets the specifications given for this requirement. [V.CTS.185]

#### 4.3.10.12.5 RESERVED

#### 4.3.10.12.6 Microbial Limits

The limitation of microbial contaminants in the internal atmosphere shall be verified by analysis. The analysis shall include a review of the vehicle cabin airflow and filtration design. The verification shall be considered successful when the analysis shows that the average continuous air flow within the vehicle can remain at or above 20 CFM per person of air that has been cleaned to have at least 99.97% of airborne particles 0.3  $\mu\text{m}$  and larger in diameter/size removed. [V.CTS.187]

#### 4.3.10.12.7 RESERVED

#### 4.3.10.12.8 RESERVED

#### 4.3.10.12.9 Condensation Limits

The condensation persistence on CTS interior surfaces shall be verified by analysis. The analysis shall consider crew induced metabolic loads in Appendix F, Table F-1 "Crewmember Metabolic Loads -Standard Day." The analysis shall include a thermal analysis to determine expected water on internal surfaces. The verification shall be considered successful when the analysis shows that condensation persistence is limited to 1 hour a day on surfaces within the internal volume throughout all flight phases except during quiescent docked operations. [V.CTS.190]

#### 4.3.10.12.10 RESERVED

#### 4.3.10.13 RESERVED

#### 4.3.10.14 Hatches and Doorways

##### 4.3.10.14.1 Hatch Bi-directional Operability

Hatch operability by a single person from both inside and outside the spacecraft during all flight phases shall be verified by demonstration. The demonstration shall occur in a flight representative vehicle with the ground and flight crews in their flight configurations. The demonstration shall consist of a subject performing the following four tasks: unlatching and

fully opening each hatch from the inside, unlatching and fully opening each hatch from the outside, closing and latching each fully-opened hatch from the inside, and closing and latching each fully-opened hatch from the outside. The verification shall be considered successful when the demonstration shows that hatch operation can be accomplished by a single person from both inside and outside the spacecraft during all flight phases. [V.CTS.170]

#### **4.3.10.14.2 Hatch Windows**

The provision of a hatch window that provides for direct visual, non-electronic observation of the opposite side of a hatch shall be verified by analysis and demonstration. The analysis shall derive the field of view necessary to observe the environment on the opposite side of the hatch with respect to the hatch in which it is installed. The demonstration shall confirm the observation of targets throughout the field of view both from the inside looking outward and the outside looking inward. The verification shall be considered successful when the demonstration shows that the direct visual, non-electronic field of view provided by the window meets the field-of-view, as determined by the analysis, required to observe the environment on the opposite side of the hatch in both viewing directions. [V.CTS.174]

#### **4.3.10.15 RESERVED**

#### **4.3.10.16 Crew Size, Mass, and Strength**

##### **4.3.10.16.1 Anthropometric Dimensions Standards**

The CTS's accommodation of the anthropometric ranges in Appendix D and applicable suit conditions shall be verified by inspection, analysis, and test. Inspection shall include a review of designs, drawings, and flight representative vehicles and extraction of measurements to compare against the information contained in Appendix D and against CTS-developed suit values. An integrated task and worksite analysis shall be performed on all crew functional areas. The task analysis shall include a determination of potential clothing required to be worn for each task, as well as, define a subset of the anthropometric dimensions in Appendix D, Table D-1 and D-2 that are critical for each task. The test shall measure a human subject while physically interacting with a crew functional area within a flight representative vehicle in the flight configuration. The test results shall be verified by means of population analytical methods, such as is described in JSC 65995, section 4.5.2.4 Evaluate the Design Using Population Analysis. The verification shall be considered successful when the inspection, analysis, and test show that the anthropometric ranges in Appendix D and applicable suited conditions have been met for the crew wearing all required protective clothing; and crew can fit, access, reach, view, and operate the human systems interfaces. [V.CTS.193]

##### **4.3.10.16.2 Crew Body Mass Standards**

The CTS's implementation of the body mass data to the design shall be verified by analysis. The analysis shall include spacecraft, cargo, crew mass, flight performance, and the center of gravity of the crewed launch vehicles and spacecraft to ensure the design is capable of delivering the entire system mass. The analysis shall evaluate the designs and load computations to compare against the information in Appendix D, "D-3 Body Mass" and "D-5 Body Segment Mass of a Crewmember" to determine if damage will occur on human systems interfaces that are normally subjected to high forces during nominal and off-nominal operations. The verification shall be considered successful when the analysis shows that the system's delivered-crew mass is equal to or greater than the maximum total crew mass per Appendix D, "D-4 Whole Body Mass for

Multiple Crew" with the crew wearing any required protective clothing and the spacecraft systems human interfaces accommodate the maximum mass of an individual crewmember per Appendix D, "D-3 Body Mass." [V.CTS.194]

#### **4.3.10.16.3 Crew Operation Loads**

The spacecraft's hardware and equipment actuation loads shall be verified by analysis and test. A task analysis shall be performed to identify human activities required for nominal and off-nominal operation that must be accomplished with each type of hardware and equipment throughout the mission. The verification shall be considered successful when the test of hardware shows the forces required for the operations are below the limit in the appropriate table in Appendix E for the task and flight configuration that requires that operation. [V.CTS.195]

#### **4.3.10.16.4 Withstand Crew Loads**

The structural integrity of crew interfaces shall be verified by analysis and test. An analysis shall determine the type of strength by which the crew would apply loads to the crew interfaces in nominal and off-nominal tasks. Crew interfaces shall be load tested to the levels in Appendix E for those types of strength. The verification shall be considered successful when the test shows that the interfaces can withstand maximum crew operation loads as defined in Appendix E, Table E-1. [V.CTS.196]

#### **4.3.10.17 Crew Support Equipment**

##### **4.3.10.17.1 Trash Management**

The spacecraft's provisions for containing and disposing of expected trash shall be verified by analysis, inspection and demonstration. A task analysis shall be performed to identify trash management activities in the applicable mission phases and environments. An analysis shall be performed for trash management design to confirm that expected trash types and volumes are characterized and that trash containment designs are appropriate for the trash types, environments and durations of containment. Engineering drawings and models shall be inspected to verify these components have been incorporated in accordance with all trash management activities and supplies identified in the task analysis. The demonstration shall be performed using a flight representative trash containment system and trash, including odor sources, while exercising expected trash operations for the duration expected until trash disposal. The demonstration shall evaluate operator use of the trash management system and that trash, particularly hazardous, cannot be inadvertently released. The verification shall be considered successful when analysis, inspection and demonstration show that the trash management system contains expected trash types and controls odors. [V.CTS.198]

##### **4.3.10.17.2 Sleep Accommodations**

The spacecraft's provisions for crew sleep shall be verified by analysis and inspection. An analysis shall be performed to determine sleep functions, operations, environment, and accommodations required. The analysis shall assess light, noise, and vibration-levels during the sleep period. Engineering drawings and models shall be inspected to verify the resulting sleep components used to enhance the sleep environment have been incorporated in the design. The verification shall be considered successful when the analysis and inspection show that the cabin environment and design accommodate crew sleep. [V.CTS.199]

##### **4.3.10.17.3 RESERVED**

#### **4.3.10.17.4 Body Waste Management**

The spacecraft's provision of a body waste management system shall be verified by analysis, demonstration, and inspection. A task analysis shall be performed to determine body waste management operations, functions and accommodations in applicable mission phases and environments. An analysis shall be performed to confirm that expected body waste containment designs are appropriate for the waste types and environments. Engineering drawings and models shall be inspected to verify these components have been incorporated in accordance with all body waste management activities and supplies identified in the task analysis. Demonstrations shall be performed using flight representative hardware in the flight configuration while exercising body waste management activities. The demonstration will show that an operator can use the body waste management system and that all particles are contained. A demonstration of waste stowage for the expected duration shall evaluate system odor control. Use of a shortened test period shall be justified by analysis. The verification shall be considered successful when the demonstration and inspection shows that a body waste management system has been provided and includes stowage, accommodation, functionality, and disposal of body waste management events and supplies for the quantities and rates found in Table 3.10.17.4-1. [V.CTS.203]

#### **4.3.10.18 RESERVED**

#### **4.3.10.19 Water**

##### **4.3.10.19.1 Potable Water Physiochemical Limits**

The spacecraft's physiochemical potable water quality shall be verified by test and analysis. The test shall include evaluation of a flight-representative water system for a length of time equal to the longest period expected between pre-flight preparation of potable water and post-flight crew recovery. Use of a shortened test period shall be justified by analysis. Samples shall be collected from all locations throughout the water system to which the crew may be exposed to verify compliance. These tests shall be conducted using standard laboratory techniques described in ISBN 0875530478, Standard Methods for Examination of Water and Wastewater, American Public Health Association or alternate methodology that will provide comparable data. The verification shall be considered successful when test data are compliant with Appendix G, Table G-1, "Potable Water Physiochemical Limits" and analysis shows that results from a short-duration test can be considered equivalent to those of a full-duration test. [V.CTS.205]

##### **4.3.10.19.2 Potable Water Microbial Limits**

The spacecraft's microbiological water quality shall be verified by test and analysis. The test shall include evaluation of a flight-representative water system for a length of time equal to the longest period expected between pre-flight preparation of potable water and post-flight crew recovery. Use of a shortened test period shall be justified by analysis. Samples shall be collected from all locations throughout the water system to which the crew may be exposed to verify compliance. These tests shall be conducted using standard laboratory techniques described in ISBN 0875530478, Standard Methods for Examination of Water and Wastewater, American Public Health Association or alternate methodology that will provide comparable data. The verification shall be considered successful when test data are compliant with Table 3.10.19.2-1, "Potable Water Microbiological Limits" and analysis shows that results from a short-duration test can be considered equivalent to those of a full-duration test. [V.CTS.206]

#### **4.3.10.19.3 Nominal Mission Water Provisions**

The spacecraft's provisioning of potable water at the specified temperatures shall be verified by analysis. The analysis shall determine the temperature of the water to be used for consumption, hygiene, and medical use during applicable mission phases. The verification shall be considered successful when the analysis shows that potable water can be provided between 18 °C (64.4 °F) and 28 °C (82.4 °F) and sufficient volume and mass capacity for stowage of a minimum of 2.6 L (88 fl oz) of potable water per crewmember per mission day for consumption and hygiene use and 1.0 L (total) of potable water for medical use, in addition to other potable water quantity requirements. [V.CTS.207]

#### **4.3.10.19.4 Water Monitoring**

The spacecraft's potable water sampling capability shall be verified by inspection and analysis. The inspection will include a review of spacecraft and potable water system designs to ensure potable water sample collection during pre-flight ground processing, in-flight, and post-flight phases. The analysis shall determine the amount of potable water stowage on the vehicle for the design reference mission utilizing maximum crew size and maximum mission duration. The verification shall be considered successful when the inspection shows capability to perform potable water sample collection and delivery of pre-flight, in-flight, and post-flight samples to NASA or a NASA-approved laboratory and the analysis shows sufficient volume and mass capacity for stowage of a minimum of 3.5 L of potable water, or approved alternative quantity, per mission for water sampling, in addition to all other potable water quantity requirements. [V.CTS.208]

#### **4.3.10.19.5 Water for Fluid Loading**

The spacecraft's provisioning of the specified quantity of potable water shall be verified by analysis. The analysis shall determine the total amount of potable water stowage on the spacecraft for the DRM utilizing maximum crew size and maximum mission duration. The verification shall be considered successful when the analysis shows sufficient volume and mass capacity for stowage of 1.4 L (48.0 fl oz) per crewmember for Earth reentry fluid loading for each of two deorbit attempts. [V.CTS.210]

#### **4.3.10.19.6 Post-Landing Water**

The spacecraft's provisioning of the specified quantity of potable water shall be verified by analysis. The analysis shall determine the total amount of potable water stowage on the spacecraft for the DRM utilizing maximum crew size and maximum mission duration. The verification shall be considered successful when the analysis shows sufficient volume and mass capacity for stowage of a minimum of 1.0 L (33.8 fl oz) of potable water per crewmember for each 8-hour period of the entire post-landing crew recovery period, and that this water is immediately accessible to crewmembers in their landing configuration, in addition to all other potable water quantity requirements. [V.CTS.211]

### **4.3.10.20 Crew Workspace/Stowage**

#### **4.3.10.20.1 RESERVED**

#### **4.3.10.20.2 Habitable Space Sizing**

The spacecraft's provision of work and habitable space, stowage, and physical accommodation shall be verified by analysis, inspection, and demonstration. A task analysis shall be performed

to identify human activities required for nominal and off-nominal operation in the applicable mission phases and environments. An analysis shall be performed to show the functional arrangement of locations and the allocation of volumes to support crew operations are consistent with Appendix K range of motion constraints. The inspection shall include the review of designs, drawings, CAD 3D models, and flight representative vehicles and extraction of measurements to compare against the information in Appendix K, "Range of Motion Data." A demonstration shall be performed of critical expected mission tasks in a flight representative vehicle in the flight configuration. The verification shall be considered successful when the analysis, inspection, and demonstration show that the measurements have been met and that the crew, wearing all required protective clothing, can complete the tasks identified within the range of motion constraints. [V.CTS.213]

### **4.3.11 Ground Support Equipment (GSE)**

#### **4.3.11.1 Design of GSE**

Verification that the design of the GSE does not invalidate flight hardware certification shall be verified by analysis and inspection. An analysis shall be performed to determine the hazards created by GSE interfaces to flight hardware. The verification shall be considered successful when an analysis and inspection determines that all hazards due to the use of GSE are controlled to preclude any risk of invalidation of flight hardware certification. [V.CTS.314]

**Appendix A: Acronyms**

<b>Acronyms</b>	<b>Phrase</b>
<b>AC</b>	Alternating Current
<b>ACGIH</b>	American Conference of Governmental Industrial Hygienists
<b>AED</b>	Automatic External Defibrillator
<b>AI</b>	Approach Initiation
<b>ALARA</b>	As Low As Reasonably Achievable
<b>AMP</b>	Ambulatory Medical Pack
<b>ATD</b>	Anthropomorphic Test Dummy
<b>ATV</b>	Automated Transfer Vehicle
<b>BDC</b>	Baseline Data Collection
<b>CCP</b>	Commercial Crew Program
<b>CCT</b>	Commercial Crew Transportation
<b>CFM</b>	Cubic Feet/Minute
<b>CHSIP</b>	Commercial Human System Integration Process
<b>CIL</b>	Critical Items List
<b>CM</b>	Configuration Management
<b>CoFTR</b>	Certification of Flight Test Readiness
<b>CO<sub>2</sub></b>	Carbon Dioxide
<b>COPV</b>	Composite Overwrapped Pressure Vessel
<b>COTS</b>	Commercial Orbital Transportation System
<b>CG</b>	Center of Gravity
<b>CP</b>	Commercial Provider
<b>CRS</b>	Cargo Resupply Contract
<b>CTS</b>	Crew Transportation System
<b>CVCC</b>	Commercial Vehicle Control Center
<b>DAEZ</b>	Downrange Abort Exclusion Zone
<b>DC</b>	Direct Current
<b>DCS</b>	Decompression Sickness
<b>DDT&amp;E</b>	Design, Development, Test and Evaluation
<b>DMCF</b>	Definitive Medical Care Facility
<b>EARD</b>	Exploration Architecture Requirements Document
<b>ECLSS</b>	Environmental Control and Life Support Systems
<b>EDL</b>	Entry, Descent and Landing
<b>EER</b>	Estimated Energy Requirements
<b>EMT</b>	Emergency Medical Technician
<b>EOM</b>	End of Mission
<b>EPA</b>	Environmental Protection Agency
<b>ESD</b>	Electrostatic Discharge
<b>ESMD</b>	NASA Exploration Systems Mission Directorate
<b>EVA</b>	Extravehicular Activity
<b>FAA</b>	Federal Aviation Administration



<b>FAR</b>	Federal Acquisition Regulation
<b>FEU</b>	Flight Equivalent Unit
<b>FIV</b>	Flow-Induced Vibration
<b>FMEA</b>	Failure Mode and Effects Analysis
<b>FTS</b>	Flight Termination System
<b>GCR</b>	Galactic Cosmic Radiation
<b>GFE</b>	Government Furnished Equipment
<b>GIDEP</b>	Government-Industry Data Exchange Program
<b>GLACIER</b>	General Laboratory Active Cryogenic ISS Experiment Refrigerator
<b>GN&amp;C</b>	Guidance, Navigation, and Control
<b>GSE</b>	Ground Support Equipment
<b>HCN</b>	Hydrogen Cyanide
<b>HCl</b>	Hydrogen Chloride
<b>HEA</b>	Human Error Analysis
<b>HEPA</b>	High Efficiency Particulate Air
<b>HIDH</b>	Human Integration Design Handbook
<b>HITL</b>	Human-in-the-Loop
<b>HQR</b>	Handling Qualities Rating
<b>HTV</b>	H-II Transfer Vehicle
<b>HUD</b>	Heads Up Display
<b>HZ</b>	Hertz
<b>IEEE</b>	Institute of Electrical and Electronic Engineers
<b>IDD</b>	Interface Definition Document
<b>IP</b>	International Partner
<b>IR</b>	Infrared
<b>IRD</b>	Interface Requirements Document
<b>ISO</b>	International Standards Organization
<b>ISS</b>	International Space Station
<b>IT</b>	Information Technology
<b>IVA</b>	Intravehicular Activity
<b>JPRCB</b>	Joint Program Requirements Control Board
<b>JSC</b>	Johnson Space Center
<b>JTT</b>	Joint Test Team
<b>KSC</b>	Kennedy Space Center
<b>LEO</b>	Low Earth Orbit
<b>LOC</b>	Loss Of Crew
<b>LOM</b>	Loss Of Mission
<b>MA</b>	Milli Ampere
<b>MCC-H</b>	International Space Station Mission Control Center – Houston
<b>MCL</b>	Mean Crew Load
<b>MCL</b>	Maximum Contaminant Levels
<b>MDL</b>	Mid Deck Locker
<b>MFCO</b>	Mission Flight Control Offices
<b>MMOD</b>	Micro Meteoroid Orbital Debris

<b>MORD</b>	Medical Operations Requirements Document
<b>MPCP</b>	Mishap Preparedness and Contingency Plan
<b>MRB</b>	Material Review Board
<b>MSDV</b>	Motion Sickness Dose Value
<b>MTBF</b>	Mean Time Between Failures
<b>MUA</b>	Materials Usage Agreement
<b>N/A</b>	Not Applicable
<b>NASA</b>	National Aeronautics and Space Administration
<b>NC</b>	Noise Criterion
<b>NCL</b>	Nominal Crew Load
<b>NDE</b>	Nondestructive Evaluation
<b>NIOSH</b>	National Institute for Occupational Safety and Health
<b>NIR</b>	Non-Ionizing Radiation
<b>NPD</b>	NASA Policy Document
<b>NPR</b>	NASA Procedural Requirement
<b>ODAR</b>	Obsolescence Driven Avionics Redesign
<b>ORU</b>	Orbital Replaceable Units
<b>OSHA</b>	Occupational Safety and Health Administration
<b>PNP</b>	Probability of No Penetration
<b>PPE</b>	Personal Protective Equipment
<b>ppCO<sub>2</sub></b>	Carbon Dioxide Partial Pressure
<b>ppO<sub>2</sub></b>	Oxygen Partial Pressure
<b>PSA</b>	Probabilistic Safety Analysis
<b>R&amp;M</b>	Reliability and Maintainability
<b>RER</b>	Respiratory Exchange Ratio
<b>RF</b>	Radio Frequency
<b>RMS</b>	Root Mean Squared
<b>RPCM</b>	Remote Power Control Module
<b>RPOD</b>	Rendezvous, Proximity Operations, and Docking
<b>RSO</b>	Range Safety Officer
<b>SAR</b>	Search and Rescue
<b>SAS</b>	Space Adaptation Syndrome
<b>SIL</b>	Speech Interference Level
<b>SMA</b>	Safety and Mission Assurance
<b>SMAC</b>	Spacecraft Maximum Allowable Concentrations
<b>SME</b>	Subject Matter Expert
<b>SPE</b>	Solar Particle Events
<b>SPL</b>	Sound Pressure Level
<b>SRD</b>	System Requirements Document
<b>SRP</b>	Safety Review Panel
<b>SSP</b>	Space Station Program
<b>SUS</b>	System Usability Scale
<b>TBC</b>	To Be Confirmed
<b>TBD</b>	To Be Determined

<b>TBR</b>	To Be Resolved
<b>TBS</b>	To Be Specified
<b>TDAD</b>	Trailing Deployable Aerodynamic Decelerator
<b>TEE</b>	Total Energy Expenditure
<b>TICB</b>	Transportation Integration Control Board
<b>TPS</b>	Thermal Protection System
<b>TWA</b>	Time Weighted Average
<b>USOS</b>	United States Operations Segment
<b>UV</b>	Ultra Violet

## Appendix B: 1100 Series Definitions

Term	Definition
<b>Abort</b>	The forced early return of the crew when failures or the existence of uncontrolled catastrophic hazards prevent continuation of the mission profile and a return is required for crew survival.
<b>Ambient Light</b>	Any surrounding light source (existing lighting conditions). This could be a combination of natural lighting (e.g., sunlight, moonlight) and any artificial light source provided. For example, in an office there would be ambient light sources of both the natural sunlight and the fluorescent lights above (general office lighting).
<b>Analysis</b>	A verification method utilizing techniques and tools, such as math models, prior test data, simulations, analytical assessments, etc. Analysis may be used in lieu of, or in addition to, other methods to ensure compliance to specification requirements. The selected techniques may include, but not be limited to, task analysis, engineering analysis, statistics and qualitative analysis, computer and hardware simulations, and analog modeling. Analysis may be used when it can be determined that rigorous and accurate analysis is possible, test is not cost effective, and verification by inspection is not adequate.
<b>Annunciate</b>	To provide a visual, tactile, or audible indication.
<b>Approach Ellipsoid</b>	A 4 x 2 x 2 km ellipsoid, centered at the ISS center of mass, with the long axis aligned with the V-Bar.
<b>Approach Initiation</b>	The approach initiation is the first rendezvous maneuver during a nominal approach that is targeted to bring the vehicle inside the ISS approach ellipsoid (AE).
<b>Ascent</b>	The period of time from initial motion away from the launch pad until orbit insertion during a nominal flight or ascent abort initiation during an abort.
<b>Ascent Abort</b>	An abort performed during ascent, where the crewed spacecraft is separated from the launch vehicle without the capability to achieve the desired orbit. The crew is safely returned to a landing site in a portion of the spacecraft nominally used for entry and landing/touchdown.
<b>Automated</b>	Automatic (as opposed to human) control of a system or operation.
<b>Autonomous</b>	Ability of a space system to perform operations independent from any ground-based systems. This includes no communication with, or real-time support from, mission control or other ground systems.
<b>Backout</b>	During mission execution, the coordinated cessation of a current activity or procedure and careful return to a known, safe state.
<b>Breakout</b>	Any action that interrupts the nominally planned free flight operations that are intended to place the spacecraft outside of a threatening location to the cooperative vehicle. This may be an automated or manually executed action. For the ISS, the area within which a vehicle poses a threat to ISS is called the Approach Ellipse.
<b>Cargo</b>	An item (or items) required to maintain the operability of the ISS and/or the health of its crew, and that must be launched and/or returned.

<b>Catastrophic Event</b>	An event resulting in the death or permanent disability of a ground closeout or flight crewmember, or an event resulting in the unplanned loss/destruction of a major element of the CTS or ISS during the mission that could potentially result in the death or permanent disability of a flight crewmember.
<b>Catastrophic Hazard</b>	A condition that could result in the death or permanent disability of a ground closeout or flight crewmember, or in the unplanned loss/destruction of a major element of the CTS during the mission that could potentially result in the death or permanent disability of a flight crewmember.
<b>Command</b>	Directive to a processor or system to perform a particular action or function.
<b>Communications Coverage</b>	Communication coverage is defined as successful link availability for nominal ascent and entry trajectories.
<b>Communications Link</b>	A communication link is established, whereas the received commands and voice from the CVCC to the spacecraft and the transmitted health and status data, crew health and medical related data, voice, telemetry, and transmitted launch vehicle and spacecraft engineering data are received.
<b>Consumable</b>	Resource that is consumed in the course of conducting a given mission. Examples include propellant, power, habitability items (e.g., gaseous oxygen), and crew supplies.
<b>Continental U.S. Airport</b>	An airport within the continental United States capable of accommodating executive jet aircraft similar to the Gulfstream series aircraft.
<b>Contingency</b>	Provisioning for an event or circumstance that is possible but cannot be predicted with certainty.
<b>Contingency Spacecraft Crew Support (CSCS)</b>	CSCS is declared when the spacecraft crew takes shelter on the ISS because the spacecraft has been determined to be unsafe for reentry. In this case, a rescue mission is required to return the spacecraft crew safely.
<b>Crew</b>	Any human onboard the spacecraft after the hatch is closed for flight or onboard the spacecraft during flight.
<b>Crew Transportation System (CTS)</b>	The collection of all space-based and ground-based systems (encompassing hardware and software) used to conduct space missions or support activity in space, including, but not limited to, the integrated space vehicle, space-based communication and navigation systems, launch systems, and mission/launch control.
<b>Critical Decision</b>	Those technical decisions related to design, development, manufacturing, ground, or flight operations that may impact human safety or mission success, as measured by defined criteria.
<b>Critical Fault</b>	Any identified fault of software whose effect would result in a catastrophic event or abort.
<b>Critical Function</b>	Mission capabilities or system functions that, if lost, would result in a catastrophic event or an abort.
<b>Critical Hazard</b>	A condition that may cause a severe injury or occupational illness.
<b>Critical Software</b>	Any software component whose behavior or performance could lead to a catastrophic event or abort. This includes the flight software, as well as ground-control software.
<b>Critical Software/Firmware</b>	Software/Firmware that resides in a safety-critical system that is a potential hazard cause or contributor, supports a hazard control or mitigation, controls

	safety-critical functions, or detects and reports 1) fault trends that indicate a potential hazard and/or 2) failures which lead to a hazardous condition.
<b>Critical (sub)System</b>	A (sub)system is assessed as critical if loss of overall (sub)system function, or improper performance of a (sub)system function, could result in a catastrophic event or abort.
<b>CTS Certification</b>	CTS certification is the documented authorization granted by the NASA Associate Administrator that allows the use of the CTS within its prescribed parameters for its defined reference missions. CTS certification is obtained prior to the first crewed flight (for flight elements) or operational use (for other systems).
<b>CTS Element</b>	One component part of the overall Crew Transportation System. For example, the spacecraft is an element of the CTS.
<b>Deconditioned</b>	“Deconditioned” defines a space crewmember whose physiological capabilities, including musculoskeletal, cardiopulmonary, and neurovestibular, have deteriorated as a result of exposure to micro-gravity and the space environment. It results in degraded crewmember performance for nominal and off-nominal mission tasks.
<b>Definitive Medical Care</b>	An inpatient medical care facility capable of comprehensive diagnosis and treatment of a crewmember's injuries or illness without outside assistance—capable of care of Category I, II, and III trauma patients. Usually a Level I trauma center, as defined by the American College of Surgeons.
<b>Demonstration</b>	A method of verification that consists of a qualitative determination of the properties of a test article. This qualitative determination is made through observation, with or without special test equipment or instrumentation, which verifies characteristics, such as human engineering features, services, access features, and transportability. Human-in-the-loop demonstration is performed for complex interfaces or operations that are difficult to verify through modeling analysis, such as physical accommodation for crew ingress and egress. Demonstration requirements are normally implemented within a test plan, operations plan, or test procedure.
<b>Docking</b>	Mating of two independently operating spacecraft or other systems in space using independent control of the two vehicles' flight paths and attitudes during contact and capture. Docking begins at the time of initial contact of the vehicles' docking mechanisms and concludes when full rigidization of the interface is achieved.
<b>Downrange Abort Exclusion Zone</b>	A geographical region of the North Atlantic Ocean to be avoided for water landings during ascent aborts for ISS missions due to rough seas and cold water temperatures. The region is depicted in Figure B-1. The St. John's abort landing area includes the waters within 200 nmi range to St John's International Airport (47° 37' N, 52° 45' W). The Shannon abort landing area includes the waters within 200 nmi range to Shannon International Airport (52° 42' N, 8° 55' W). Note: The northern and southern bounds of the DAEZ in the ISS Mission DAEZ figure are notional, as these bounds are limited only by steering and cross-range performance along the ascent trajectory and are not formally constrained.

<p><b>Downrange Abort Exclusion Zone Figure</b></p>	
<p><b>Figure B-1 Ascent Downrange Abort Exclusion Zone</b></p>	
<p><b>Emergency</b></p>	<p>An unexpected event or events during a mission that requires immediate action to keep the crew alive or serious injury from occurring.</p>
<p><b>Emergency Egress</b></p>	<p>Capability for a crew to exit the vehicle and leave the hazardous situation or catastrophic event within the specified time. Flight crew emergency egress can be unassisted or assisted by ground personnel.</p>
<p><b>Emergency Equipment and Systems</b></p>	<p>Systems (ground or flight) that exist solely to prevent loss of life in the presence of imminent catastrophic conditions. Examples include fire suppression systems and extinguishers, emergency breathing devices, Personal Protective Equipment (PPE) and crew escape systems. Emergency systems are not considered a leg of failure tolerance for the nominal, operational equipment and systems, and do not serve as a design control to prevent the occurrence of a catastrophic condition.</p>
<p><b>Emergency Medical Services</b></p>	<p>Services required to provide the crewmembers with immediate medical care to prevent loss of life or aggravated physical or psychological conditions.</p>
<p><b>End of Mission</b></p>	<p>The planned landing time for the entire mission, including the nominal pre-flight agreed to docked mission duration.</p>
<p><b>Entry</b></p>	<p>The period of time that begins with the final commitment to enter the atmosphere from orbit or from an ascent abort, and ending when the velocity of the spacecraft is zero relative to the landing surface.</p>
<p><b>Entry Interface</b></p>	<p>The point in the entry phase where the spacecraft contacts the atmosphere (typically at a geodetic altitude of 400,000 feet), resulting in increased heating to the thermal protection system and remainder of the spacecraft exterior surfaces.</p>
<p><b>External Launch Constraint</b></p>	<p>Conditions outside the CTS provider's control, such as range weather constraints or faults with range or ISS assets, or weather constraints affecting abort rescue forces capabilities. Range weather examples include ability to visually monitor the initial phases of the launch for range safety, etc. Non-weather range constraints include range safety radar and telemetry systems availability, flight termination systems readiness, clearance of air, land, sea, etc.</p>
<p><b>Failure</b></p>	<p>Inability of a system, subsystem, component, or part to perform its required function within specified limits.</p>

<b>Failure Tolerance</b>	The ability to sustain a certain number of failures and still retain capability. A component, subsystem, or system that cannot sustain at least one failure is not considered to be failure tolerant.
<b>Fault</b>	An undesired system state and/or the immediate cause of failure (e.g., maladjustment, misalignment, defect, or other). The definition of the term “fault” envelopes the word “failure,” since faults include other undesired events, such as software anomalies and operational anomalies. Faults at a lower level could lead to failures at the higher subsystem or system level.
<b>Flight Configuration</b>	The arrangement, orientation and operational state of system elements and cargo, vehicle cabin layout, flight software mode, and crew complement, clothing and equipment in the applicable mission or ground phase necessary in verification to evaluate the attributes called out in the requirement.
<b>Flight Hardware</b>	All components and systems that comprise the internal and external portions of the spacecraft, launch vehicle, launch abort system, and crew worn equipment.
<b>Flight Operations</b>	All operations of the integrated space vehicle and the crew and ground teams supporting the integrated space vehicle from liftoff until landing.
<b>Flight Phase</b>	A particular phase or timeframe during a mission is referred to as a flight phase. The term “all flight phases” is defined as the following flight phases: pre-launch, ascent, onorbit free-flight, docked operations, deorbit/entry, landing, and post-landing.
<b>Flight Representative</b>	Description of a test-article used in verifications in which the attributes under evaluation are equivalent to the flight article.  Example: Human-in-the-loop tests for spacecraft egress must use an equivalent cabin layout, seats and restraints, and hatch configuration and masses. However, the propulsion system does not need to be functional, as it is not under evaluation.
<b>Flight Rules</b>	Established redline limits for critical flight parameters. Each has pre-planned troubleshooting procedures with pre-approved decisions for expected troubleshooting results.
<b>Flight Systems</b>	Any equipment, system, subsystem or component that is part of the integrated space system.
<b>Flight Termination</b>	An emergency action taken by range safety when a vehicle violates established safety criteria for the protection of life and property. This action circumvents the vehicles’ normal control modes and ends its powered and/or controlled flight.
<b>Free Flight Operations</b>	Onorbit operations that occur when the spacecraft is not in contact with any part of the ISS.
<b>Ground Crew</b>	Operations personnel that assist the flight crew in entering the spacecraft, closing the hatch, performing leak checks, and working on the integrated space vehicle at the pad during launch operations.
<b>Ground Hardware</b>	All components and systems that reside on the ground in support of the mission, including the Commercial Vehicle Control Center, launch pad, ground support equipment, recovery equipment, facilities, and communications, network, and tracking equipment.



<b>Ground Processing</b>	The work required to prepare the launch vehicle and spacecraft for mission from final assembly/integration/test through launch and resumes after landing for recovery of crew and cargo.
<b>Ground Support Equipment</b>	Any non-flight equipment, system(s), ground system(s), or devices specifically designed and developed for a direct physical or functional interface with flight hardware to support the execution of ground production or processing. The following are not considered to be GSE: <ul style="list-style-type: none"> <li>• Tools designed for general use and not specifically for use on flight hardware.</li> <li>• Ground Support Systems that interface with GSE Facilities.</li> </ul>
<b>Habitable</b>	The environment that is necessary to sustain the life of the crew and to allow the crew to perform their functions in an efficient manner.
<b>Hazard</b>	A state or a set of conditions, internal or external to a system, that has the potential to cause harm.
<b>Hazard Analysis</b>	The process of identifying hazards and their potential causal factors.
<b>Health and Status Data</b>	Data, including emergency, caution, and warning data, that can be analyzed or monitored describing the ability of the system or system components to meet their performance requirements.
<b>Human Error</b>	Either an action that is not intended or desired by the human or a failure on the part of the human to perform a prescribed action within specified limits of accuracy, sequence, or time that fails to produce the expected result and has led or has the potential to lead to an unwanted consequence.
<b>Human Error Analysis (HEA)</b>	A systematic approach used to evaluate human actions, identify potential human error, model human performance, and qualitatively characterize how human error affects a system. HEA provides an evaluation of human actions and error in an effort to generate system improvements that reduce the frequency of error and minimize the negative effects on the system. HEA is the first step in Human Risk Assessment and is often referred to as qualitative Human Risk Assessment.
<b>Human-in-the-Loop Evaluation</b>	Human-in-the-loop evaluations involve having human subjects, which include NASA crewmembers as a subset of the test subject population, perform identified tasks in a representative mockup, prototype, engineering, or flight unit. The fidelity of mockups used for human-in-the-loop evaluations may range from low-fidelity, minimal representation, to high-fidelity, complete physical and/or functional representation, relevant to the evaluation. Ideally, the fidelity of human-in-the-loop mockups and tests increases as designs mature for more comprehensive evaluations. Further information on human-in-the-loop evaluations throughout system design can be found in JSC 65995 CHSIP.
<b>Human-System Integration</b>	The process of integrating human operations into the system design through analysis, testing, and modeling of human performance, interface controls/displays, and human-automation interaction to improve safety, efficiency, and mission success.
<b>Ill or Injured</b>	Refers to a crewmember whose physiological and/or psychological well-being and health has deteriorated as a result of an illness (e.g., appendicitis) or injury (e.g., trauma, toxic exposure) and requires medical capabilities exceeding those available on the ISS and transportation to ground-based definitive medical care.

	Ill or injured crewmember performance for nominal and off-nominal mission tasks will be degraded.
<b>Inspection</b>	A method of verification that determines conformance to requirements by the use of standard quality control methods to ensure compliance by review of drawings and data. This method is used wherever documents or data can be visually used to verify the physical characteristics of the product instead of the performance of the product.
<b>Integrated Operations</b>	All operations starting at 90 minutes prior to the ISS Approach Initiation and lasting until the vehicle leaves the ISS Approach Ellipsoid on a non-return trajectory.
<b>Integrated Space Vehicle</b>	The integrated space vehicle includes all flight elements physically connected for the phase of flight from post lift-off until spacecraft separation.
<b>Landing</b>	The final phase or region of flight consisting of transition from descent to an approach, touchdown, and coming to rest.
<b>Landing Site</b>	<p><b>Supported Landing Sites:</b> A fully supported site on a Continental U.S. land mass or waters directly extending from the coast with CTS recovery forces on station at the time of landing. The landing site zone extends through nominally expected dispersions from the landing site point.</p> <p><u>Designated Primary Landing Site</u> – A supported landing site-intended for landing at the time of spacecraft undock.</p> <p><u>Alternate Landing Site</u> – A supported landing site to which the spacecraft landing can be diverted in the event the deorbit burn is delayed.</p> <p><b>Unsupported Landing Sites:</b></p> <p><u>Emergency Landing</u> – Any unsupported site (land or water) arrived at due to critical failures that force immediate return and preclude landing at a designated primary or alternate landing sites.</p>
<b>Launch Commit Criteria</b>	Established redline limits for critical launch parameters. Each has pre-planned troubleshooting procedures with pre-approved decisions for expected troubleshooting results.
<b>Launch Opportunity</b>	The period of time during which the relative position of the launch site, the ISS orbital plane, and ISS phase angle permit the launch vehicle to insert the spacecraft into a rendezvous trajectory with the ISS (northerly launches only due to range constraints). The ISS is in-plane with the Eastern Range approximately every 23 hours and 36 minutes.
<b>Launch Probability</b>	The probability that the system will successfully complete a scheduled launch event. The launch opportunity will be considered scheduled at 24 hours prior to the opening of the launch window.
<b>Launch Vehicle</b>	The vehicle that contains the propulsion system necessary to deliver the energy required to insert the spacecraft into orbit.
<b>Life-Cycle</b>	The totality of a program or project extending from formulation through implementation, encompassing the elements of design, development, verification, production, operation, maintenance, support, and disposal.
<b>Loss of Crew</b>	Death or permanently debilitating injury to one or more crewmembers.
<b>Loss of Mission</b>	Loss of, or the inability to complete enough of, the primary mission objectives, such that a repeat mission must be flown.

<b>Maintenance</b>	The function of keeping items or equipment in, or restoring them to, a specified operational condition. It includes servicing, test, inspection, adjustment/alignment, removal, replacement, access, assembly/disassembly, lubrication, operation, decontamination, installation, fault location, calibration, condition determination, repair, modification, overhaul, rebuilding, and reclamation.
<b>Manual Control</b>	The crew's ability to bypass automation in order to exert direct control over a space system or operation. For control of a spacecraft's flight path, manual control is the ability for the crew to affect any flight path within the capability of the flight control system. Similarly, for control of a spacecraft's attitude, manual control is the ability for the crew to affect any attitude within the capability of the flight/attitude control system.
<b>MCC-H Mission Authority</b>	<ul style="list-style-type: none"> <li>• MCC-H has authority to make final decisions regarding spacecraft operations, including but not limited to Go/No-Go decisions and safety of flight and crew(s).</li> <li>• Beginning with either ISS integrated operations, or 30 minutes before the first required ISS configuration or crew activity in support of the spacecraft on rendezvous (e.g., ISS attitude maneuver, appendage configuration, USOS GPS configuration), whichever comes first.</li> <li>• Ending with either the end of ISS integrated operations, or when ISS is not required to maintain its configuration (e.g., ISS attitude, USOS GPS configuration, or appendages in a configuration) to support the spacecraft, whichever comes later.</li> <li>• Applies anytime the spacecraft free-drift trajectory, including dispersions, is predicted to enter the ISS AE within the next 24 hours.</li> </ul>
<b>Mission</b>	The mission begins with entry of the crew into the spacecraft, includes delivery of the crew to/from ISS, and ends with successful delivery of the crew to NASA after landing.
<b>Mission Critical</b>	Item or function that must retain its operational capability to assure no mission failure (i.e., for mission success).
<b>Operations Personnel</b>	All persons supporting ground operations or flight operations functions of the CTS. Examples of these personnel are listed below: Persons responsible for the production, assembly/integration/test, validation, and maintenance of flight hardware, production facilities, launch site facilities, operations facilities, or ground support equipment (GSE). Persons involved with supporting or managing the launch countdown, crew training, or mission during flight. Persons involved in post-flight recovery.
<b>Orbit</b>	This flight phase starts just after final orbit insertion and ends at the completion of the first deorbit burn.
<b>Override</b>	To take precedence over system control functions.
<b>Pad Abort</b>	An abort performed where the crewed spacecraft is separated from the launch vehicle while the launch vehicle remains on the launch pad. As a result, the crewed spacecraft is safely transported to an area which is not susceptible to the dangers associated with the hazardous environment at the launch pad.
<b>Permanent Disability</b>	A non-fatal occupational injury or illness resulting in permanent impairment through loss of, or compromised use of, a critical part of the body, to include

	major limbs (e.g., arm, leg), critical sensory organs (e.g., eye), critical life-supporting organs (e.g., heart, lungs, brain), and/or body parts controlling major motor functions (e.g., spine, neck). Therefore, permanent disability includes a non-fatal injury or occupational illness that permanently incapacitates a person to the extent that he or she cannot be rehabilitated to achieve gainful employment in their trained occupation and results in a medical discharge from duties or civilian equivalent.
<b>Portable Fire Suppression System</b>	A system comprised of one or more portable handheld fire extinguishers and access ports. These access ports allow the user to discharge fire suppressant into enclosed areas with potential ignition sources. See also 3.10.12.2 Use of Hazardous Chemicals.
<b>Post-Landing</b>	The mission phase beginning with the actual landing event when the vehicle has no horizontal or vertical motion relative to the surface and ending when the last crewmember is loaded on the aircraft for return to JSC.
<b>Proximity Operations</b>	The flight phase including all times during which the vehicle is in free flight beginning just prior to Approach Initiation (AI) execution and ending when the vehicle leaves the Approach Ellipsoid (AE).
<b>Quiescent Docked Operations</b>	The state of the CTS spacecraft while it is docked to the ISS with hatches open and ISS services, as called out in SSP 50808, connected and operational. From this state, the vehicle can support immediate ingress and transition into safe haven in the case of an emergency.
<b>Recovery</b>	The process of proceeding to a designated nominal landing site, and retrieving crew, flight crew equipment, cargo, and payloads after a planned nominal landing.
<b>Reliability</b>	The probability that a system of hardware, software, and human elements will function as intended over a specified period of time under specified environmental conditions.
<b>Rendezvous</b>	The flight phase of executing a series of onorbit maneuvers to move the spacecraft into the proximity of its target. This phase starts with orbit insertion and ends just prior to the approach initiation.
<b>Safe Haven</b>	A functional association of capabilities and environments that is initiated and activated in the event of a potentially life-threatening anomaly and allows human survival until rescue, the event ends, or repair can be affected. It is a location at a safe distance from or closed off from the life-threatening anomaly.
<b>Safety</b>	The absence from those conditions that can cause death, injury, occupational illness, damage to or loss of equipment or property, or damage to the environment.
<b>Safety Critical</b>	A condition, event, operation, process, function, equipment or system (including software and firmware) with potential for personnel injury or loss, or with potential for loss or damage to vehicles, equipment or facilities, loss or excessive degradation of the function of critical equipment, or which is necessary to control a hazard.
<b>Search and Rescue</b>	The process of locating the crew, proceeding to their position, and providing assistance.
<b>Software</b>	Computer instructions or data stored electronically. Systems software includes the operating system and all the utilities that enable the computer to function.

	Applications software includes programs that do real work for users, such as word processors, spreadsheets, data management systems, and analysis tools. Software can be Commercial Off-The-Shelf (COTS), contractor developed, Government furnished, or combinations thereof.
<b>Spacecraft</b>	All system elements that are occupied by the crew during the space mission and provide life support functions for the crew. The crewed element includes all the subsystems that provide life support functions for the crew.
<b>Space System</b>	The collection of all space-based and ground-based systems (encompassing hardware and software) used to conduct space missions or support activity in space, including, but not limited to, the integrated space vehicle, space-based communication and navigation systems, launch systems, and mission/launch control.
<b>Stowage</b>	The accommodation of physical items in a safe and secure manner in the spacecraft. This does not imply that resources other than physical accommodations (e.g., power, thermal, etc.) are supplied.
<b>Subsystem</b>	A secondary or subordinate system within a system (such as the spacecraft) that performs a specific function or functions. Examples include electrical power, guidance and navigation, attitude control, telemetry, thermal control, propulsion, structures subsystems. A subsystem may consist of several components (hardware and software) and may include interconnection items such as cables or tubing and the support structure to which they are mounted.
<b>System</b>	The aggregate of the ground segment, flight segment, and workforce required for crew rescue and crew transport.
<b>Task Analysis</b>	Task analysis is an iterative human-centered design process through which user tasks are identified and analyzed. It involves 1) the identification of the tasks and subtasks involved in a process or system, and 2) analysis of those tasks (e.g., who performs them, what equipment is used, under what conditions, the priority of the task, dependence on other tasks). The focus is on the human and how they perform the task, rather than the system. Results can help determine the hardware or software that should be developed/used for a particular task, the ideal allocation of tasks to humans vs. automation, and the criticality of tasks, which drive design decisions. Further information on task analysis can be found in JSC 65995 CHSIP, Section 4.1.
<b>Test</b>	A method of verification in which technical means, such as the use of special equipment, instrumentation, simulation techniques, and the application of established principles and procedures, are used for the evaluation of components, subsystems, and systems to determine compliance with requirements. Test will be selected as the primary method when analytical techniques do not produce adequate results; failure modes exist, which could compromise personnel safety, adversely affect flight systems or payload operation, or result in a loss of mission objectives. The analysis of data derived from tests is an integral part of the test program and should not be confused with analysis as defined above. Tests will be used to determine quantitative compliance to requirements and produce quantitative results.
<b>Time-Critical Cargo</b>	Cargo that requires late stowage pre-launch (within 24 hours of launch) and early removal post-landing (within 1 hour of crew egress).

<b>Transport</b>	Launch of crew and cargo to and return from the ISS.
<b>Validation</b>	Proof that the product accomplishes the intended purpose. May be determined by a combination of test, analysis, and demonstration.
<b>Verification</b>	Proof of compliance with a requirement or specifications based on a combination of test, analysis, demonstration, and inspection.

## Appendix C: TBC/TBD/TBR/TBS Tables

Issue	Section	Details
<b>None</b>	<b>None</b> <b>None</b>	<b>None</b>

## Appendix D: Crew Physical Dimension and Mass Design Data

**Table D-1: Vehicle Design Critical Anthropometric Dimensions**

Design Concern	Critical Dimension	Minimal Clothing	
		Min (cm [in.])	Max (cm [in.])
Maximum vertical clearance	Stature, Standing <sup>4</sup>	149.5 (58.9)	190.5 (75.0)
Vertical seating clearance	Sitting Height <sup>5</sup>	78.2 (30.8)	101.3 (39.9)
Placement of panels to be within line-of-sight	Eye Height, Sitting <sup>4</sup>	66.5 (26.2)	88.9 (35.0)
Top of seatback	Acromial Height, Sitting <sup>5</sup>	49.5 (19.5)	68.1 (26.8)
Placement of objects which may be over lap (panels, control wheel, etc.)	Thigh Clearance, Sitting	13.0 (5.1)	20.1 (7.9)
Height of panels in front of subject	Knee Height, Sitting	45.5 (17.9)	63.5 (25.0)
Height of seat pan	Popliteal Height, Sitting	33.0 (13.0)	50.0 (19.7)
Downward reach of subject	Wrist Height, Sitting (with arm to the side)	39.6 (15.6)	54.6 (21.5)
Placement of restraint straps	Biacromial Breadth	32.3 (12.7)	44.5 (17.5)
Width of seatback	Bideltoid Breadth	37.8 (14.9)	53.0 (20.9)
Side clearance envelope, possible seatback width	Forearm-Forearm Breadth	38.9 (15.3)	66.0 (26.0)
Width of seat pan	Hip Breadth, Sitting <sup>1</sup>	31.5 (12.4)	46.5 (18.3)
Length of seat pan	Buttock-Popliteal Length, Sitting	42.2 (16.6)	57.2 (22.5)
Placement of panels in front of subject	Buttock-Knee Length, Sitting	52.1 (20.5)	69.9 (27.5)



Rudder pedal design, foot clearance	Foot Length, Sitting	21.6 (8.5)	30.5 (12.0)
Placement of control panels, maximum reach	Thumbtip Reach, Sitting	65.0 (25.6)	90.9 (35.8)
<p><sup>1</sup> For seated measurements, the largest female hip breadth is larger than the largest male hip breadth, and the smallest male hip breadth is smaller than the smallest female hip breadth; therefore, male data are used for the Min dimension, and female data are used for the Max dimension.</p> <p><sup>2</sup> DELETED</p> <p><sup>3</sup> DELETED</p> <p><sup>4</sup> For measurements that include the length of the spine, add 3% of stature to allow for spinal elongation due to micro-gravity exposure.</p> <p><sup>5</sup> For measurements that include the length of the spine in seated posture, add 6% of seated height to allow for spinal elongation due to micro-gravity exposure.</p>			

The minimum and maximum critical dimension values are representative of the NASA astronaut corps and based on the 2009 anthropometric selection criteria for astronaut applicants as documented in JSC 64548 Anthropometric and Strength Selection Criteria for Astronaut Applicants. The critical anthropometric dimensions provide measurements commonly deemed as most important to consider for vehicle and suit design based on past experience. For example, sitting height is a critical dimension for seat design because it ensures head clearance, while biacromial breadth is critical to proper design of restraint straps. Vehicle design must also consider crew uniform and use critical dimensions for crew wearing minimal clothing, unpressurized suit, or pressurized suit, as appropriate. The CTS suit minimum and maximum critical dimensions are needed for verification of vehicle design to accommodate the suited crewmember. Refer to the JSC 65995 CHSIP section 4.5 for additional information and guidance on using and evaluating critical anthropometric dimensions in vehicle design.

**Table D-2: Suit Design Critical Anthropometric Dimensions**

Design Concern	Critical Dimension	Minimal Clothing	
		Min (cm [in.])	Max (cm [in.])
Maximum vertical clearance	Stature, Standing	149.5 (58.9)	190.5 (75.0)
Torso Sizing	Vertical Trunk Diameter	55.9 (22.0)	75.9 (29.9)
Leg length	Crotch height	66.5 (26.2)	95.8 (37.7)
Knee break	Knee height mid-patella	39.6 (15.6)	57.9 (22.8)
Torso sizing	Chest breadth	23.6 (9.3)	39.4 (15.5)
Torso sizing	Chest depth	19.1 (7.5)	30.2 (11.9)
Neck ring and helmet sizing	Head length	17.3 (6.8)	21.6 (8.5)
Maximum circumference of upper leg	Thigh circumference	47.8 (18.8)	71.9 (28.3)
Maximum circumference of upper arm	Biceps circumference flexed	22.9 (9.0)	40.4 (15.9)
Torso sizing	Chest circumference	75.7 (29.8)	118.6 (46.7)
Arm sizing	Inter-wrist distance	115.1 (45.3)	161.8 (63.7)
Functional arm break, arm length	Inter-elbow distance	72.6 (28.6)	101.3 (39.9)
Lower torso sizing	Waist depth	15.0 (5.9)	30.0 (11.8)
Lower torso sizing	Hip breadth <sup>1</sup>	29.7 (11.7)	40.6 (16.0)
Arm sizing	Wrist-to-wall distance	54.6 (21.5)	77.7 (30.6)

<sup>1</sup>For standing measurements, the largest female hip breadth is larger than the largest male hip breadth; therefore, female data are used for both the Minimum and the Maximum dimension.

**Table D-3: Whole Body Mass**

<b>Crewmember Body Mass (kg [lb])</b>		
	<b>Unsuited</b>	<b>Suited*</b>
<b>Min</b>	42.64 (94)	78.93 (174)
<b>Max</b>	110.22 (243)	146.51 (323)
<p>*The crewmember body mass for "Suited" includes 36.29 kg (80 lb) for the pressure garment and does not include crew survival gear or EVA gear.</p> <p>Data are projected forward to 2015.</p>		

Body mass data is important for various systems. Most importantly, body mass properties must be used for propulsion calculations and ensuring the structural integrity of human system interfaces. Propulsion and system dynamic calculations depend on accurate data for the full range of crewmember mass to size the propulsion system and design proper vehicle dynamic controls. Vehicle systems with human system interfaces are to be designed such that they will not be damaged after being subjected to the forces that a crewmember can impart on that interface during acceleration. As an example, body support systems (e.g., seats, brackets, and restraints) are to accommodate forces exerted by a suited crewmember, under all anticipated acceleration and gravity environments. The mass data provided is for unsuited crew and includes body mass, center of mass, and moment of inertia for both whole-body and body-segments.

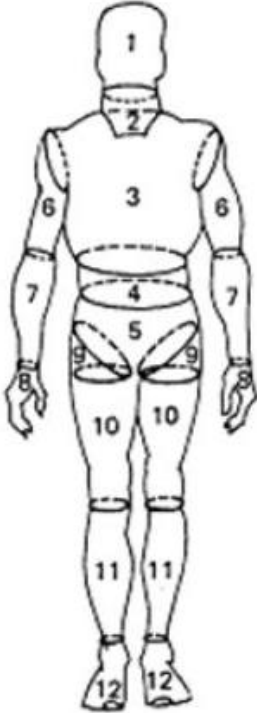
**Table D-4: Whole Body Mass for Multiple Crew, Unsuited**

<b>Crew Number</b>	<b>Mean (kg(lbs))</b>	<b>Std. Dev (kg(lbs))</b>	<b>95th%tile (kg(lbs))</b>	<b>80th%tile (kg(lbs))</b>	<b>Per Crewmember Weight (kg(lbs))</b>
<b>1</b>	X	X	110.2 (243.1)*	X	X
<b>2</b>	154.7 (340.3)	16.1 (35.4)	181.1 (398.4)	168.3 (370.3)	84.2 (185.1)
<b>3</b>	232.0 (510.4)	19.7 (43.3)	264.4 (581.6)	248.6 (546.9)	82.9 (182.3)
<b>4</b>	309.1 (680.0)	22.7 (49.9)	346.4 (762.2)	328.2 (722.0)	82.1 (180.5)
<b>5</b>	386.8 (850.9)	25.5 (56.2)	428.8 (943.3)	408.3 (898.3)	81.7 (179.7)
<b>6</b>	463.9 (1020.6)	27.8 (61.2)	509.6 (1121.2)	487.3 (1072.1)	81.2 (178.7)

\*99<sup>th</sup> percentile value

It is unreasonable to design for a worst-case scenario of all crewmembers having a maximum body mass. Applied to a multi-crew configuration, the limits raise to unacceptably high numbers; 440.2 kg (972.4 lbs) for a 4 crew configuration and 661.2 kg (1458.6 lbs) for a 6 crew configuration. This number is far too high to use as a design requirement for crew weight, and illogical since there is a very low probability that four 99<sup>th</sup> percentile male crewmembers will fly at any given time. A Monte Carlo simulation was performed to derive the above table. The Monte Carlo simulation generated a new group weight population by randomly selecting groups of individuals from an existing population over a certain number of iterations.

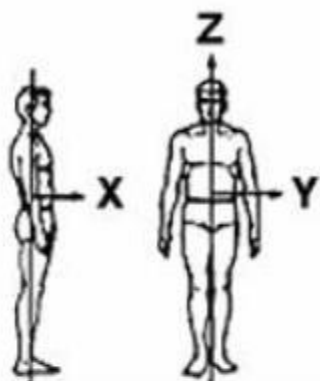
**Table D-5: Body Segment Mass of a Crewmember, Unsuit**

	Segment	Mass (kg [lb])	
		Min	Max
	1 Head	2.99 (6.59)	5.03 (11.08)
	2 Neck	0.49 (1.08)	1.39 (3.07)
	3 Thorax	11.35 (25.02)	34.33 (75.69)
	4 Abdomen	2.14 (4.72)	3.25 (7.16)
	5 Pelvis	5.62 (12.4)	16.46 (36.29)
	6 Upper arm	0.91 (2.0)	2.74 (6.04)
	7 Forearm	0.59 (1.29)	1.86 (4.09)
	8 Hand	0.24 (0.52)	0.66 (1.45)
	9 Hip flap	2.22 (4.9)	4.79 (10.55)
	10 Thigh minus hip flap	3.86 (8.12)	8.48 (18.69)
	11 Calf	1.94 (4.28)	5.11 (11.27)
	12 Foot	0.44 (0.98)	1.26 (2.77)
	Torso (5 + 4 + 3)	19.11 (42.13)	54.05 (119.15)
	Thigh (9 + 10)	5.91 (13.03)	13.26 (29.24)
Forearm plus hand (7+8)	0.82 (1.81)	2.51 (5.54)	

Data are projected forward to 2015.

**Whole Body Center of Mass:** Assuming that the human flesh was homogeneous, it can also be assumed that the center of volume is at the center of mass location. McConville et al. (1980) and Young et al. (1983) provided ranges for the location of the center of volume for the male and female, respectively, in each study. Because regression equations were not given for the center of volume, the range values from the McConville et al. (1980) and Young et al. (1983) studies were used here. Specific values for the locations of the center of mass with respect to the anatomical axes were taken from each study to form the range; specifically, the upper range was set by the male upper range, and the lower range was set by the female lower range.

**Table D-6: Whole Body Center of Mass Location**



The axes in the figure above represent the anatomical axes.

Dimension	Min (cm,(in))	Max (cm,(in))
L(Xa)	-15.27 (-6.01)	-6.40 (-2.52)
L(Ya)	-1.22 (-0.48)	0.97 (0.38)
L(Za)	-3.81 (-1.5)	8.15 (3.21)

## Appendix E: Crewmember Strength Data

Strength refers to a person's ability to generate force. Applying the following strength requirements will result in a minimum and maximum applied crew load to be used for operational and hardware design. The minimum load pertains to operational strength that accommodates the weakest person while the maximum load represents the force the hardware must be able to withstand without failure. It is important to note that these requirements apply to intentional forces applied by the crewmember. Durability is applicable to structural integrity of hardware due to non-intentional crew forces which is handled through the structural design process defined in JSC 65829, *Loads and Structural Dynamics Requirements for Spaceflight Hardware*.





**Max Crew Loads** - Vehicle components and equipment are to be designed to withstand large forces exerted by a strong crewmember during nominal hardware operation, without breaking or sustaining damage that would deem the hardware inoperable. Humans may also exert high forces when operating controls in emergency situations, such as attempting to open a hatch for emergency egress. The resulting possible damage to equipment could make it impossible to respond safely to the emergency. To avoid overdesign, a task analysis is performed to identify which interfaces must tolerate maximum crew operational loads. This includes identifying critical hardware that may be inadvertently used as a mobility aid or restraint. The data provided in the tables are for unsuited, suited-unpressurized, and suited-pressurized conditions. Data was derived from a collection of journal articles associated with human strength data.

**Minimum Crew Loads** - The design must allow for all crewmembers to perform any of the requested tasks efficiently and effectively, thus ensuring task and/or mission success. The data provided is for unsuited, suited-unpressurized, and suited-pressurized conditions. A human-centered design process is to be used when implementing operational strength limits. Analysis of expected crew operations, activities, and tasks is to drive the design of human-machine interfaces. The analysis should evaluate and define activities/tasks in terms of criticality and required postures.





For this purpose tasks that involve the possibility of a single failure causing loss of life or vehicle have a definition of Criticality 1 Operations in the following tables. Tasks involving LOM alone have a Criticality 2 Operations. The values in the criticality 1 and 2 columns also include the decrement factor(s) to reflect the deconditioning effects on crewmembers after an extended duration of mission. All other tasks fall into the "Other Operations" category. It is important to note that the designer should be careful not to implement multiple safety factors. For example, NASA-STD-5017 torque/force margin requirements (4.10.0) levy an extra safety factor on the applied torque/force to a given mechanism. Implementing this requirement along with the already built in safety factor (i.e., criticality) in the strength tables results in an overly conservative design.

Data was derived from a collection of journal articles associated with human strength data. In addition, other references were used, such as the MIL-STD-1472F and the Occupational and Biomechanics textbook (Chaffin, D. B., Occupation Biomechanics, Second Edition, John Wiley & Sons, Inc., 1991), to set a standard for very specific strength data such as lifting strength.

**Table E-1: Crewmember Strength - Unsuitied**  
**(Page 1 of 7)**





Type Of Strength		Minimum Crew Operation Loads (N(Lbf))			Maximum Crew Operational Loads (N(Lbf))
		Crit 1 Operations	Crit 2 Operations	Other Operations	
<b>One Handed Pulls</b>		<b>One Handed Pulls</b>			
Seated Horizontal Pull In <sup>2</sup> [Subject in a seated position pulls towards his/her body. Unilateral/Isometric measurement]		111 (25)	147 (33)	276 (62)	449 (101)
Seated Vertical Pull Down <sup>2</sup> [Subject in a seated position pulls downwards. Unilateral/Isometric measurement]		125 (28)	165 (37)	311 (70)	587 (132)
Seated Vertical Pull Up <sup>2</sup> [Sitting erect with feet apart, dominant hand grasping D-ring located directly to the front above the floor, pulling upward while keeping shoulder squares & other arm in lap]		49 (11)	67 (15)	125 (28)	756 (170)
Standing Vertical Pull Up <sup>2</sup> [Standing erect with feet apart, dominant hand grasping underside of D-ring located directly to the side above standing surface, pulling upward while keeping shoulders square and other arm relaxed at side]		53 (12)	71 (16)	133 (30)	725 (163)

**Table E-1: Crewmember Strength - Unsuited**  
**(Page 2 of 7)**


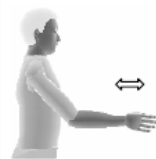

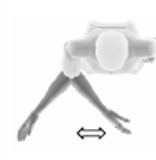
Type Of Strength		Minimum Crew Operation Loads (N(Lbf))			Maximum Crew Operational Loads (N(Lbf))
		Crit 1 Operations	Crit 2 Operations	Other Operations	
<b>Two Handed Pulls</b>		<b>Two Handed Pulls</b>			
Standing Vertical Pull Down <sup>2</sup> [Standing erect with feet apart, with both hands holding handle located above shoulders, pulling downward]		138 (31)	182 (41)	343 (77)	707 (159)
Standing Pull in <sup>2</sup> [Standing erect with feet apart, with both hands holding handle located in front, pulling inward towards body]		58 (13)	80 (18)	147 (33)	391 (88)
Standing Vertical Pull Up <sup>2</sup> [Standing with feet apart with a slight bend at the knees and waist, grasping a handle with both hands located directly in front and pulling upward]		89 (20)	116 (26)	218 (49)	1437 (323)
Seated Vertical Pull Up <sup>2</sup> [Sitting erect with feet apart, grasping both sides of handle located directly to the front above the floor, pulling upward using arms and shoulders]		93 (21)	125 (28)	236 (53)	1188 (267)





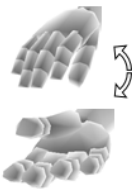
**Table E-1: Crewmember Strength - Unsuitd  
(Page 3 of 7)**

Type Of Strength		Minimum Crew Operation Loads (N(Lbf))			Maximum Crew Operational Loads (N(Lbf))
		Crit 1 Operations	Crit 2 Operations	Other Operations	
<b>One Handed Push</b>		<b>One Handed Push</b>			
Seated Horizontal Push Out <sup>2</sup> [Subject in a seated position pushing away from his/her body. Unilateral/Isometric measurement]		89 (20)	116 (26)	218 (49)	436 (98)
Seated Vertical Push Up <sup>2</sup> [Subject in a seated position pushing upward in a vertical direction. Unilateral/Isometric measurement]		67 (15)	85 (19)	160 (36)	280 (63)
<b>Two Handed Push</b>		<b>Two Handed Push</b>			
Standing Vertical Push Down <sup>2</sup> [Standing with feet apart with a slight bend at the knees and waist, grasping a handle with both hands located directly in front and pushing downwards]		102 (23)	133 (30)	254 (57)	525 (118)
Standing Horizontal Push Out <sup>1</sup> [Standing erect with feet apart, with both hands holding handle located in front, pushing out away from body]		62 (14)	85 (19)	165 (37)	596 (134)





**Table E-1: Crewmember Strength - Unsuitd  
(Page 4 of 7)**

Type Of Strength		Minimum Crew Operation Loads (N(Lbf))			Maximum Crew Operational Loads (N(Lbf))
		Crit 1 Operations	Crit 2 Operations	Other Operations	
<b>Two Handed Push</b>		<b>Two Handed Push</b>			
Standing Vertical Push Up <sup>2</sup> [Standing erect with feet apart, grasping from below, both sides of handle located directly in front above standing surface. Pushing upwards using arms and shoulders]		76 (17)	98 (22)	187 (42)	1094 (246)
<b>Arm</b>		<b>Arm</b>			
Arm Pull <sup>2</sup> [Subject pulls handle forward and backward]		44 (10)	58 (13)	107 (24)	249 (56)
Arm Push <sup>2</sup> [Subject pushes handle forward and backward]		40 (9)	53 (12)	98 (22)	222 (50)
Arm Up <sup>2</sup> [Subject pushes and pulls handle in a various directions as shown by the figures]		18 (4)	22 (5)	40 (9)	107 (24)
Arm Down <sup>2</sup> [Subject pushes and pulls handle in a various directions as shown by the figures]		22 (5)	31 (7)	58 (13)	116 (26)
Arm In <sup>2</sup> [Subject moves handle medially]		22 (5)	31 (7)	58 (13)	98 (22)
Arm Out <sup>2</sup> [Subject moves handle laterally]		13 (3)	18 (4)	36 (8)	76 (17)



**Table E-1: Crewmember Strength - Unsuitied  
(Page 5 of 7)**

Type Of Strength		Minimum Crew Operation Loads (N(Lbf))			Maximum Crew Operational Loads (N(Lbf))
		Crit 1 Operations	Crit 2 Operations	Other Operations	
<b>Lifting</b>		<b>Lifting</b>			
Lifting Strength <sup>2</sup> [Standing with feet apart with a slight bend at the knees and waist, grasping a handle with both hands located directly in front and pulling upward using primarily arms and shoulders, and legs]		36 (8)	49 (11)	93 (21)	1228 (276)
<b>Elbow</b>		<b>Elbow</b>			
Flexion <sup>2</sup> [Subject moves forearm in a sagittal plane around the elbow joint]		13 (3)	18 (4)	36 (8)	347 (78)
Extension <sup>2</sup> [Subject moves forearm in a sagittal plane around the elbow joint]		27 (6)	36 (8)	67 (15)	249 (56)
Type Of Strength		Minimum Crew Operational Loads (N·m(in-lb))			Maximum Crew Operational Loads (N·m(in-lb))
		Crit 1 Operations	Crit 2 Operations	Other Operations	
Pronation <sup>2</sup> [Subject rotates hands and forearms medially]		0.8 (7.4)	1.1 (10)	2.1 (18.4)	11.3 (100)
Supination <sup>2</sup> [Subject rotates hands and forearms laterally]		0.8 (7.4)	1.1 (10)	2.1 (18.4)	11.3 (100)

**Table E-1: Crewmember Strength - Unsuitied  
(Page 6 of 7)**





Type Of Strength		Minimum Crew Operation Loads (N(Lbf))			Maximum Crew Operational Loads (N(Lbf))
		Crit 1 Operations	Crit 2 Operations	Other Operations	
<b>Wrist &amp; Hand</b>		<b>Wrist &amp; Hand</b>			
Wrist Flexion <sup>2</sup> [Subject bends wrist in a palmar direction]		31 (7)	40 (9)	76 (17)	209 (47)
Wrist Extension <sup>2</sup> [Subject bends the wrist in a dorsal direction]		13 (3)	18 (4)	36 (8)	85 (19)
Pinch <sup>1</sup> [Subject squeezes together the thumb and finger]		9 (2)	13 (3)	18 (4)	200 (45)
Grasp <sup>1</sup> [Subject maintains an eccentric tight hold of an object]		347 (78)	463 (104)	694 (156)	1219 (274)
Grip <sup>1</sup> [Subject maintains a concentric tight hold of an object]		49 (11)	67 (15)	102 (23)	783 (176)
<b>Leg</b>		<b>Leg</b>			
Hip Flexion <sup>2</sup> [Subject moves leg in the sagittal plane around the hip joint toward the front of the body]		116 (26)	156 (35)	289 (65)	645 (145)
Hip Extension <sup>2</sup> [Subject moves upper and lower leg in a sagittal plane around the hip joint]		191 (43)	254 (57)	476 (107)	658 (148)

**Table E-1: Crewmember Strength - Unsuited  
(Page 7 of 7)**





Type Of Strength		Minimum Crew Operation Loads (N(Lbf))			Maximum Crew Operational Loads (N(Lbf))
		Crit 1 Operations	Crit 2 Operations	Other Operations	
<b>Leg</b>		<b>Leg</b>			
Leg Press <sup>1</sup> [Subject moves leg in a sagittal plane around the hip joint toward the back of the body]		618 (139)	827 (186)	1552 (349)	2584 (581)
Knee Flexion <sup>1</sup> [Subject moves lower leg in a sagittal plane around the knee joint]		53 (12)	71 (16)	138 (31)	325 (73)
Knee Extension <sup>1</sup> [Subject moves lower leg in a sagittal plane around the knee joint]		142 (32)	191 (43)	383 (86)	783 (176)
<sup>1</sup> Post-space flight maximal measured strength decrement. <sup>2</sup> Post-space flight estimated strength decrement. Range is 0%-26%. Average estimated is 20%. Based on max EDOMP Data. Not all motions were measured on EDOMP.					

Note: To convert forces to torque for elbow, hip, knee, or wrist exertions, use the longest or shortest moment arm based on the anthropometric values provided in Table D-1 as appropriate.





**Table E-2: Crewmember Strength - Suited Unpressurized  
(Page 1 of 6)**

Type of Strength		Minimum Crew Operational Loads- N (lbf)			Maximum Crew Operational Loads- N (lbf)
		Crit 1 Operations	Crit 2 Operations	Other Operations	
<b>One Handed Pulls</b>		<b>One Handed Pulls</b>			
Seated Horizontal Pull In <sup>2</sup>  [Subject in a seated position pulls towards his/her body. Unilateral/Isometric measurement]		78(18)	103(23)	193(43)	314(71)
Seated Vertical Pull Down <sup>2</sup>  [Subject in a seated position pulls downwards. Unilateral/Isometric measurement]		88(20)	116(26)	218(49)	411(92)
Seated Vertical Pull Up <sup>2</sup>  [Sitting erect with feet apart, dominant hand grasping D-ring located directly to the front above the floor, pulling upward while keeping shoulder squares & other arm in lap]		34(8)	47(11)	88(20)	529(119)
Standing Vertical Pull Up <sup>2</sup>  [Standing erect with feet apart, dominant hand grasping underside of D-ring located directly to the side above standing surface, pulling upward while keeping shoulders square and other arm relaxed at side]		37(8)	50(11)	93(21)	508(114)

**Table E-2: Crewmember Strength - Suited Unpressurized  
(Page 2 of 6)**




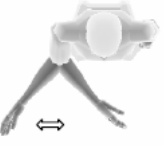
Type of Strength		Minimum Crew Operational Loads- N (lbf)			Maximum Crew Operational Loads- N (lbf)
		Crit 1 Operations	Crit 2 Operations	Other Operations	
<b>Two Handed Pulls</b>		<b>Two Handed Pulls</b>			
Standing Vertical Pull Down <sup>2</sup>  [Standing erect with feet apart, with both hands holding handle located above shoulders, pulling downward]		97(22)	127(29)	240(54)	495(111)
Standing Pull in <sup>2</sup>  [Standing erect with feet apart, with both hands holding handle located in front, pulling inward towards body]		41(9)	56(13)	103(23)	274(62)
Standing Vertical Pull Up <sup>2</sup>  [Standing with feet apart with a slight bend at the knees and waist, grasping a handle with both hands located directly in front and pulling upward]		62(14)	81(18)	153(34)	1006(226)
Seated Vertical Pull Up <sup>2</sup>  [Sitting erect with feet apart, grasping both sides of handle located directly to the front above the floor, pulling upward using arms and shoulders]		65(15)	88(20)	165(37)	832(187)

**Table E-2: Crewmember Strength - Suited Unpressurized  
(Page 3 of 6)**



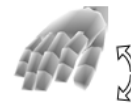
Type of Strength		Minimum Crew Operational Loads- N (lbf)			Maximum Crew Operational Loads- N (lbf)
		Crit 1 Operations	Crit 2 Operations	Other Operations	
<b>One Handed Push</b>		<b>One Handed Push</b>			
Seated Horizontal Push Out <sup>2</sup> [Subject in a seated position pushing away from his/her body. Unilateral/Isometric measurement]		62(14)	81(18)	153(34)	305(69)
Seated Vertical Push Up <sup>2</sup> [Subject in a seated position pushing upward in a vertical direction. Unilateral/Isometric measurement]		47(11)	60(13)	112(25)	196(44)
<b>Two Handed Push</b>		<b>Two Handed Push</b>			
Standing Vertical Push Down <sup>2</sup> [Standing with feet apart with a slight bend at the knees and waist, grasping a handle with both hands located directly in front and pushing downwards]		71(16)	93(21)	178(40)	368(83)
Standing Horizontal Push Out <sup>1</sup> [Standing erect with feet apart, with both hands holding handle located in front, pushing out away from body]		43(10)	60(13)	116(26)	417(94)








**Table E-2: Crewmember Strength - Suited Unpressurized  
(Page 4 of 6)**

Type of Strength		Minimum Crew Operational Loads- N (lbf)			Maximum Crew Operational Loads- N (lbf)
		Crit 1 Operations	Crit 2 Operations	Other Operations	
<b>Two Handed Push</b>		<b>Two Handed Push</b>			
Standing Vertical Push Up <sup>2</sup> [Standing erect with feet apart, grasping from below, both sides of handle located directly in front above standing surface. Pushing upwards using arms and shoulders]		53(12)	69(15)	131(29)	766(172)
<b>Arm</b>		<b>Arm</b>			
Arm Pull <sup>2</sup> [Subject pulls handle forward and backward]		31(7)	41(9)	75(17)	174(39)
Arm Push <sup>2</sup> [Subject pushes handle forward and backward]		28(6)	37(8)	69(15)	155(35)
Arm Up <sup>2</sup> [Subject moves handle up]		13(3)	15(4)	28(6)	75(17)
Arm Down <sup>2</sup> [Subject moves handle down]		15(4)	22(5)	41(9)	81(18)
Arm In <sup>2</sup> [Subject moves handle medially]		15(4)	22(5)	41(9)	69(15)
Arm Out <sup>2</sup> [Subject moves handle laterally]		9(2)	13(3)	25(6)	53(12)

**Table E-2: Crewmember Strength - Suited Unpressurized  
(Page 5 of 6)**




Type of Strength		Minimum Crew Operational Loads- N (lbf)			Maximum Crew Operational Loads- N (lbf)
		Crit 1 Operations	Crit 2 Operations	Other Operations	
<b>Lifting</b>		<b>Lifting</b>			
Lifting Strength <sup>2</sup> [Standing with feet apart with a slight bend at the knees and waist, grasping a handle with both hands located directly in front and pulling upward using primarily arms and shoulders, and legs]		25(6)	34(8)	65(15)	860(193)
<b>Elbow</b>		<b>Elbow</b>			
Flexion <sup>2,3</sup> [Subject moves forearm in a sagittal plane around the elbow joint]		9 (2)	13 (3)	25 (6)	243 (55)
Extension <sup>2,3</sup> [Subject moves forearm in a sagittal plane around the elbow joint]		19 (4)	25 (6)	47 (11)	174 (39)
Type Of Strength		Minimum Crew Operational Loads (N:m(in-lb))			Maximum Crew Operational Loads (N:m(in-lb))
		Crit 1 Operations	Crit 2 Operations	Other Operations	
<b>Wrist &amp; Hand</b>		<b>Wrist &amp; Hand</b>			
Pronation <sup>2</sup> [Subject rotates hands and forearms medially]		0.7 (6.4)	0.9 (8.5)	1.8 (16)	13.1 (116)
Supination <sup>2</sup> [Subject rotates hands and forearms laterally]		0.7 (6.4)	0.9 (8.5)	1.8 (16)	13.1 (116)

**Table E-2: Crewmember Strength - Suited Unpressurized  
(Page 6 of 6)**




Wrist & Hand		Wrist & Hand			
Wrist Flexion <sup>2,3</sup> [Subject bends wrist in a palmar direction]		22 (5)	28 (6)	53 (12)	146 (33)
Wrist Extension <sup>2,3</sup> [Subject bends the wrist in a dorsal direction]		9 (2)	13 (3)	25 (6)	60 (13)
Pinch <sup>1</sup> [Subject squeezes together the thumb and finger]		14 (3)	20 (5)	27 (6)	300(68)
Type of Strength		Minimum Crew Operational Loads- N (lbf)			Maximum Crew Operational Loads- N (lbf)
		Crit 1 Operations	Crit 2 Operations	Other Operations	
Grasp <sup>1,3</sup> [Subject maintains an eccentric tight hold of an object]		243 (55)	324 (73)	486 (109)	853 (192)
Grip <sup>1</sup> [Subject maintains a concentric tight hold of an object]		25 (6)	34 (8)	51 (12)	392 (88)
Leg		Leg			
Hip Flexion <sup>2,3</sup> [Subject moves leg in the sagittal plane around the hip joint toward the front of the body]		81 (18)	109 (25)	202 (46)	452 (102)
Knee Flexion <sup>1,3</sup> [Subject moves lower leg in a sagittal plane around the knee joint, decreasing the angle between the upper and lower leg]		37 (8)	50 (11)	97 (22)	228 (51)
Knee Extension <sup>1,3</sup> [Subject moves lower leg in a sagittal plane around the knee joint, increasing the angle between the upper and lower leg]		99 (22)	134 (30)	268 (60)	548 (123)
1. Post space flight maximal measured strength decrement. 2. Post space flight estimated strength decrement. Range is 0% - 47%. Average estimated is 33%. Based on CRV Requirements Document. 3. Suit decrement not measured directly, but estimated based on functional strength testing of other movements.					

Note: To convert forces to torque for elbow, hip, knee, or wrist exertions, use the longest or shortest moment arm based on the anthropometric values provided in Table D-1 as appropriate.




**Table E-3: Crewmember Strength - Suited Pressurized  
(Page 1 of 8)**

Type Of Strength		Minimum Crew Operation Loads (N(Lbf))			Maximum Crew Operational Loads (N(Lbf))
		Crit 1 Operations	Crit 2 Operations	Other Operations	
<b>One Handed Pulls</b>		<b>One Handed Pulls</b>			
Seated Horizontal Pull In <sup>2</sup> [Subject in a seated position pulls towards his/her body. Unilateral/ Isometric measurement]		56(13)	74(17)	138(31)	225(51)
Seated Vertical Pull Down <sup>2</sup> [Subject in a seated position pulls downwards. Unilateral/Isometric measurement]		63(14)	83(19)	156(35)	294(66)
<b>One Handed Pulls</b>		<b>One Handed Pulls</b>			
Seated Vertical Pull Up <sup>2</sup> [Sitting erect with feet apart, dominant hand grasping D-ring located directly to the front above the floor, pulling upward while keeping shoulder squares & other arm in lap]		25(6)	34(8)	63(14)	378(85)




**Table E-3: Crewmember Strength - Suited Pressurized  
(Page 2 of 8)**

Type Of Strength		Minimum Crew Operation Loads (N(Lbf))			Maximum Crew Operational Loads (N(Lbf))
		Crit 1 Operations	Crit 2 Operations	Other Operations	
<b>One Handed Pulls</b>		<b>One Handed Pulls</b>			
Standing Vertical Pull Up <sup>2</sup> [Standing erect with feet apart, dominant hand grasping underside of D-ring located directly to the side above standing surface, pulling upward while keeping shoulders square and other arm relaxed at side]		27(6)	36(8)	67(15)	363(82)
<b>Two Handed Pulls</b>		<b>Two Handed Pulls</b>			
Standing Vertical Pull Down <sup>2</sup> [Standing erect with feet apart, with both hands holding handle located above shoulders, pulling downward]		69(16)	91(21)	172(39)	354(80)
Standing Pull In <sup>2</sup> [Standing erect with feet apart, with both hands holding handle located in front, pulling inward towards body]		29(7)	40(9)	74(17)	196(44)


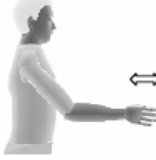

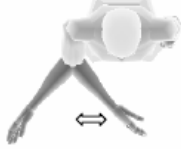
**Table E-3: Crewmember Strength - Suited Pressurized  
(Page 3 of 8)**

Type Of Strength		Minimum Crew Operation Loads (N(Lbf))			Maximum Crew Operational Loads (N(Lbf))
		Crit 1 Operations	Crit 2 Operations	Other Operations	
<b>Two Handed Pulls</b>		<b>Two Handed Pulls</b>			
Standing Vertical Pull Up <sup>2</sup> [Standing with feet apart with a slight bend at the knees and waist, grasping a handle with both hands located directly in front and pulling upward]		45(10)	58(13)	109(25)	719(162)
Seated Vertical Pull Up <sup>2</sup> [Sitting erect with feet apart, grasping both sides of handle located directly to the front above the floor, pulling upward using arms and shoulders]		47(11)	63(14)	118(27)	594(134)
<b>One Handed Push</b>		<b>One Handed Push</b>			
Seated Horizontal Push Out <sup>2</sup> [Subject in a seated position pushing away from his/her body. Unilateral/Isomet ric measurement]		45(10)	58(13)	109(25)	218(49)

**Table E-3: Crewmember Strength - Suited Pressurized  
(Page 4 of 8)**

Type Of Strength		Minimum Crew Operation Loads (N(Lbf))			Maximum Crew Operational Loads (N(Lbf))
		Crit 1 Operations	Crit 2 Operations	Other Operations	
<b>One Handed Push</b>		<b>One Handed Push</b>			
Seated Vertical Push Up <sup>2</sup> [Subject in a seated position pushing upward in a vertical direction. Unilateral/Isomet ric measurement]		34(8)	43(10)	80(18)	140(32)
<b>Two Handed Push</b>		<b>Two Handed Push</b>			
Standing Vertical Push Down <sup>2</sup> [Standing with feet apart with a slight bend at the knees and waist, grasping a handle with both hands located directly in front and pushing downwards]		51(12)	67(15)	127(29)	263(59)
Standing Horizontal Push Out <sup>1</sup> [Standing erect with feet apart, with both hands holding handle located in front, pushing out away from body]		31(7)	43(10)	83(19)	298(67)

**Table E-3: Crewmember Strength - Suited Pressurized  
(Page 5 of 8)**

Type Of Strength		Minimum Crew Operation Loads (N(Lbf))			Maximum Crew Operational Loads (N(Lbf))
		Crit 1 Operations	Crit 2 Operations	Other Operations	
<b>Two Handed Push</b>		<b>Two Handed Push</b>			
Standing Vertical Push Up <sup>2</sup> [Standing erect with feet apart, grasping from below, both sides of handle located directly in front above standing surface. Pushing upwards using arms and shoulders]		38(9)	49(11)	94(21)	547(123)
<b>Arm</b>		<b>Arm</b>			
Arm Pull <sup>2</sup> [Subject pulls handle forward and backward]		22(5)	29(7)	54 (12)	125 (28)
Arm Push <sup>2</sup> [Subject pushes handle forward and backward]		20(5)	27(6)	49 (11)	111 (25)
Arm Up <sup>2</sup> [Subject moves handle up]		9(2)	11(3)	20 (5)	54(12)
Arm Down <sup>2</sup> [Subject moves handle down]		11(3)	16(4)	29(7)	58(13)
Arm In <sup>2</sup> [Subject moves handle medially]		11(3)	16(4)	29(7)	49 (11)
Arm Out <sup>2</sup> [Subject moves handle laterally]		7(2)	9(2)	18 (4)	38 (9)



**Table E-3: Crewmember Strength - Suited Pressurized  
(Page 6 of 8)**



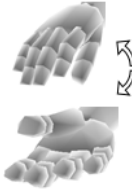






Type Of Strength		Minimum Crew Operation Loads (N(Lbf))			Maximum Crew Operational Loads (N(Lbf))
		Crit 1 Operations	Crit 2 Operations	Other Operations	
<b>Lifting</b>		<b>Lifting</b>			
Lifting Strength <sup>2</sup> [Standing with feet apart with a slight bend at the knees and waist, grasping a handle with both hands located directly in front and pulling upward using primarily arms and shoulders, and legs]		18(4)	25(6)	47(11)	614(138)
<b>Elbow</b>		<b>Elbow</b>			
Flexion <sup>2,3</sup> [Subject moves forearm in a sagittal plane around the elbow joint]		7 (2)	9 (2)	18 (4)	174 (39)
Extension <sup>2,3</sup> [Subject moves forearm in a sagittal plane around the elbow joint]		14 (3)	18 (4)	34 (8)	125 (28)
Type Of Strength		Minimum Crew Operational Loads (N:m(in-lb))			Maximum Crew Operational Loads (N:m(in-lb))
		Crit 1 Operations	Crit 2 Operations	Other Operations	
<b>Wrist &amp; Hand</b>		<b>Wrist &amp; Hand</b>			
Pronation <sup>2</sup> [Subject rotates hands and forearms medially]		0.9 (8)	1.2 (11)	2.3 (20)	13 (115)
Supination <sup>2</sup> [Subject rotates hands and forearms laterally]		0.9 (8)	1.2 (11)	2.3 (20)	13 (115)

Table E-3: Crewmember Strength - Suited Pressurized  
(Page 7 of 8)

Type Of Strength		Minimum Crew Operation Loads (N(Lbf))			Maximum Crew Operational Loads (N(Lbf))
		Crit 1 Operations	Crit 2 Operations	Other Operations	
<b>Wrist &amp; Hand</b>		<b>Wrist &amp; Hand</b>			
Wrist Flexion <sup>2,3</sup> [Subject bends wrist in a palmar direction]		19 (4)	25 (6)	37 (8)	101 (23)
Wrist Extension <sup>2,3</sup> [Subject bends the wrist in a dorsal direction]		7 (2)	9 (2)	14 (3)	33 (7)
Pinch <sup>1</sup> [Subject squeezes together the thumb and finger]		14 (3)	20 (5)	27 (6)	300(68)
Grasp <sup>1,3</sup> [Subject maintains an eccentric tight hold of an object]		174 (39)	232 (52)	347 (78)	610 (137)
Grip <sup>1</sup> [Subject maintains a concentric tight hold of an object]		25 (6)	34 (8)	51 (12)	392 (88)

**Table E-3: Crewmember Strength - Suited Pressurized  
(Page 8 of 8)**

Type Of Strength		Minimum Crew Operation Loads (N(Lbf))			Maximum Crew Operational Loads (N(Lbf))
		Crit 1 Operations	Crit 2 Operations	Other Operations	
<b>Leg</b>		<b>Leg</b>			
Hip Flexion <sup>2,3</sup> [Subject moves leg in the sagittal plane around the hip joint toward the front of the body]		58 (13)	78 (18)	145 (33)	323 (73)
Hip Extension <sup>2,3</sup> [Subject moves leg in a sagittal plane around the hip joint toward the back of the body]		96 (22)	127 (29)	238 (54)	329 (74)
Leg Press <sup>1,3</sup> [Subject pushes a weight away from them using their legs]		309 (70)	414 (93)	776 (175)	1292 (291)
Knee Flexion <sup>1,3</sup> [Subject moves lower leg in a sagittal plane around the knee joint]		27 (6)	36 (8)	69 (16)	163 (37)
Knee Extension <sup>1</sup> [Subject moves lower leg in a sagittal plane around the knee joint]		71 (16)	96 (22)	192 (43)	392 (88)
1. Post space flight maximal measured strength decrement. 2. Post space flight estimated strength decrement. Range is 0% - 47%. Average estimated is 33%. Based on CRV Requirements Document. 3. Suit decrement not measured directly, but estimated based on functional strength testing of other movements.					

Note: To convert forces to torque for elbow, hip, knee, or wrist exertions, use the longest or shortest moment arm based on the anthropometric values provided in Table D-1 as appropriate.

## Appendix F: Metabolic Loads

### F.1 Metabolic Loads

In order to allow calculation of vehicle environmental control system capacity, it is necessary to know expected crewmember metabolic loads, which will be affected by the magnitude of work being performed. Three tables are provided with metabolic rates for unsuited crew, IVA suited crew, and post-landing suited crew.

Table F-1 provides estimates of metabolically generated heat (column 5), water (column 6), and CO<sub>2</sub> (column 9) for an individual unsuited crewmember, standard mission day, without exercise. This table was populated with physiologically measured parameters as well as 41-Node man simulations. These are expected crew induced loads based on the assumptions and conditions stated in the legend, and therefore will be altered if any of these variables change. Total heat output from a single crewmember is the sum of sensible (dry) heat and wet heat outputs. The sensible (dry) heat component includes only direct radiation and convection of heat from a crewmember. Total wet heat includes two components: 1) latent heat, including heat in water vapor, which is exhaled, and that of which evaporates directly from the skin, and 2) sweat run-off, which includes heat in sweat which leaves the body in the form of liquid.

Since exercise will not be mandated on such a short mission, the peak metabolic load was derived from terrestrial metabolic rate data for moderate activity and the expected crewmember response to the dynamic phases of flight. Due to expected g-forces, vibration, and crewmember neuro-sensory response, the dynamic flight phases were assumed to produce the highest amount of metabolic loads induced on the system by the crewmembers outside of exercise. As a reference, the longest duration of dynamic flight during a mission is currently 26 minutes, which occurs during re-entry for the Shuttle. It is recommended that the system has the capability of handling the highest peak metabolic load for duration of 30 minutes to ensure crew safety.

**Table F-1: Individual Crewmember Metabolic Loads - Standard Day, Unsuited**

Activity	Duration (hr)	Total Heat Output Rate (BTU/crew-hr)	Sensible (dry) Heat Output Rate (BTU/crew-hr)	Wet Heat Output (BTU/crew-hr)	Water Vapor Output Rate (lbm/crew-hr)	O <sub>2</sub> Consumption Rate (lbm/crew-hr)	CO <sub>2</sub> Output Rate (lbm/crew-hr)
Sleep	8	300	213	87	0.0835	0.0484	0.0602
Light	12	449	310	139	0.1334	0.0713	0.0903
Peak	4	549	318	231	0.2217	0.0872	0.1104
Total/Day	24	9,984	6,696	3,288	3.16	1.59	2.0

## Rationale and Input Assumptions for Table F-1:

- 1) *Male - Male because more astronauts are male than female, and with a crew of males, metabolic rates will encompass the loads generated by that of a mixed crew or a crew of all females.*
- 2) *82 kg Weight - Current astronaut corps average weight for males is 78 kg and projected male astronaut corps average weight for 2015 is 82 kg. Additional calculations of metabolic expenditure were also made assuming different masses of crewmembers, and the output/loads change in a corresponding linear fashion; however the 82 kg assumed mass is felt to be most representative for sizing ECLSS systems.*
- 3) *Thermo-Neutral Environment - Constant Temp = 70 °F (21 deg C) and Constant Dew Point = 50 °F (10 deg C), a team of Physiologist, Engineers and Scientist agreed on environmental conditions for the model input.*
- 4) *Astronaut Corps Fitness Level - max VO<sub>2</sub> = 48 mL/kg/min +/- 6 mL/kg/min, this value was quantified from actual VO<sub>2</sub> max testing data and applied to the model for oxygen consumption during exercise as well as converted into BTU/hr for a model input.*
- 5) *Respiratory quotient/Respiratory Exchange Ratio (RER) - Historically a range of 0.87 - 0.92 has been found for CO<sub>2</sub> production. This quotient or ratio can rise to as high as 1 during intense exercise sessions. A team of Physiologists, Engineers and Scientists agreed on the RER for the model input taking into account that this is a critical element of crew health, especially while living in close quarters, and considering the expected level of activity.*
- 6) *Exercise is not required for the very short duration ISS missions*
- 7) *Vehicle Pressure - Described to the team by ECLSS as being 10.2 psia for planned standard operating pressure in LEO and likely for transit phases, so this value was used as an input to the modeling. While the Spacecraft minimum required pressure is 14.7 psi, the values provided in Table F-1 are applicable.*
- 8) *0 g - There is only microgravity in space so this was used as a model input.*
- 9) *Clothing - There are several thermodynamic models for the human system under certain conditions and stresses and these models predict different outcomes based on the amount of clothing. The model input for clothing is short sleeved t-shirt and shorts and the insulation and convection properties that apply to that clothing type were used in the modeling.*
- 10) *Sleeping metabolic rate of 300 BTU/hr was agreed upon by a team of Physiologists, Engineers and Scientists and is within the range of historical data during non-wakeful activity.*
- 11) *Nominal metabolic rate of 474 BTU/hr was agreed upon by a team of Physiologists, Engineers and Scientists and is within the range of historical data for typical Intravehicular Activity level.*
- 12) *The 41-Node man model has been used and incorporated into NASA testing, verifications, validations since the 1960s and from different data analysis has shown to be accurate within 5% when similar constants and variables are chosen.*

Table F-2 provides the metabolic loads for individual suited IVA crewmember.

**Table F-2: Suited IVA Crew Metabolic Loads Table**

Activity	Total Heat Output (Btu/crew-hr)	Sensible (dry) Heat Output Rate (Btu/crew-hr)	Wet Heat Output (Btu/crew-hr)	Water Vapor Output Rate (lbm/crew-hr)	O <sub>2</sub> Consumption Rate (lbm/crew-hr)	CO <sub>2</sub> Output Rate (lbm/crew-hr)
Sleep	300	230	70	0.0671	0.0484	0.0612
Light	450	365	85	0.0816	0.0725	0.0918
Moderate	550	455	95	0.0912	0.0887	0.1122
Launch/Landing	900	415	230	0.221	0.145	0.183

Table F-3 provides the metabolic rates for nominal post-landing, suited crewmember.

**Table F-3: Nominal Post-Landing Metabolic Rates (Suited)**

Total Heat Output Rate	Sensible (dry) Heat Output Rate	Wet heat Output	Water Vapor Output Rate	O <sub>2</sub> Consumption Rate	CO <sub>2</sub> Consumption Rate
BTU/hr	BTU/hr	BTU/hr	lbm/hr	lbm/hr	lbm/hr
350	275	75	0.072	0.0567	0.0717
400	320	80	0.0768	0.0647	0.0819
450	365	85	0.0816	0.07238	0.0922
452	367	85	0.0818	0.0732	0.0926
500	410	90	0.0864	0.08089	0.1024
585	487	99	0.0945	0.0947	0.1198
650	545	105	0.1008	0.1052	0.1331
1500	1298	202	0.1939	0.2428	0.3072

The off-nominal post-landing metabolic rates for suit doffing is estimated to average 650 BTU/hr and have peak load of 1500 BTU/hr for up to 15 minutes. These estimates are based on analysis performed for Orion suit doffing as documented in IL-HSIR-72 Table E1-4.

**Appendix G: Food and Potable Water****Table G-1: Potable Water Physiochemical Limits**

<b><i>Aesthetic:</i></b>		
<i>Taste</i>	3	<i>TTN</i>
<i>Odor</i>	3	<i>TON</i>
<i>Turbidity</i>	1	<i>NTU</i>
<i>Color, True</i>	15	<i>PCU</i>
<i>Free &amp; Dissolved Gas<sup>1</sup></i>	5	%
<i>Acidity (pH)</i>	4.5–9.0	<i>N/A</i>
<b><i>Chemical:</i></b>		
<i>Ammonia<sup>2</sup></i>	1	<i>mg/L</i>
<i>Antimony<sup>2</sup></i>	2	<i>mg/L</i>
<i>Arsenic</i>	0.01	<i>mg/L</i>
<i>Barium<sup>2</sup></i>	10	<i>mg/L</i>
<i>Cadmium<sup>2</sup></i>	0.022	<i>mg/L</i>
<i>Chloride</i>	250	<i>mg/L</i>
<i>Chlorine</i>	4	<i>mg/L</i>
<i>Chromium</i>	0.23	<i>mg/L</i>
<i>Copper</i>	1.0	<i>mg/L</i>
<i>Cyanide</i>	0.2	<i>mg/L</i>
<i>Fluoride</i>	2	<i>mg/L</i>
<i>Iron</i>	0.3	<i>mg/L</i>
<i>Lead<sup>6</sup></i>	0.009	<i>mg/L</i>
<i>Manganese<sup>2</sup></i>	0.3	<i>mg/L</i>
<i>Mercury</i>	0.002	<i>mg/L</i>
<i>Nickel<sup>2</sup></i>	0.3	<i>mg/L</i>
<i>Nitrate (as Nitrogen, NO<sub>3</sub>-N)</i>	10	<i>mg/L</i>
<i>Nitrite (as Nitrogen, NO<sub>2</sub>-N)</i>	1.0	<i>mg/L</i>
<i>Potassium</i>	340	<i>mg/L</i>
<i>Selenium</i>	0.01	<i>mg/L</i>
<i>Silver<sup>2</sup></i>	0.4	<i>mg/L</i>
<i>Sulfate</i>	250	<i>mg/L</i>
<i>Total Dissolved Solids</i>	500	<i>mg/L</i>

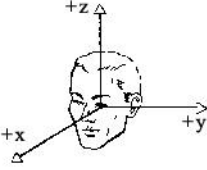
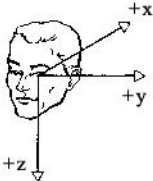
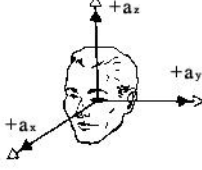
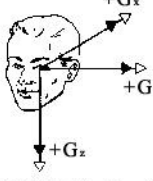
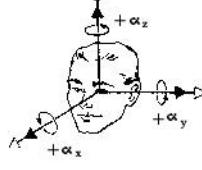
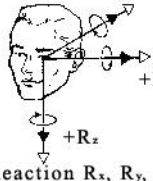
Total Iodine <sup>3</sup>	0.2	mg/L
Zinc <sup>2</sup>	2.0	mg/L
Total Organic Carbon <sup>2</sup>	3	mg/L
Acetone <sup>2</sup>	15	mg/L
Alkylamines (di) <sup>2</sup>	0.3	mg/L
Alkylamines (mono) <sup>2</sup>	2	mg/L
Alkylamines (tri) <sup>2</sup>	0.4	mg/L
Benzene <sup>2</sup>	0.07	mg/L
Caprolactum <sup>2</sup>	100	mg/L
Chloroform <sup>2</sup>	6.5	mg/L
Di(2-ethylhexyl) phthalate <sup>2</sup>	20	mg/L
Di-n-butyl phthalate <sup>2</sup>	40	mg/L
Dichloromethane <sup>2</sup>	15	mg/L
Ethylene glycol <sup>2</sup>	4	mg/L
Formaldehyde <sup>2</sup>	12	mg/L
Formate <sup>2</sup>	2,500	mg/L
2-Mercaptobenzothiazole <sup>2</sup>	30	mg/L
Methanol <sup>2</sup>	40	mg/L
Methylethylketone <sup>2</sup>	54	mg/L
Phenol <sup>2</sup>	4	mg/L
Propylene glycol <sup>2</sup>	1700	mg/L
n-Phenyl-beta-naphthylamine <sup>2</sup>	260	mg/L
Semi-volatile Organic Compounds( EPA Method 625 )	EPA MCL <sup>4,5</sup>	mg/L
Volatile Organic Compounds listed in EPA 524.2, Rev. 4	EPA MCL <sup>4,5</sup>	mg/L

**NOTES:** (TTN = threshold taste number, TON = threshold odor number, NTU = nephelometric turbidity unit, PCU = platinum-cobalt unit)

- Free gas at vehicle atmospheric pressure and 98.6 °F (37 deg C), dissolved gas saturated at vehicle atmospheric pressure and 98.6 °F (37 deg C).
- 1,000-day SWEG in JSC 63414, Spacecraft Water Exposure Guidelines (SWEG).
- JSC-28379 “Medical Effects of Iodine: Proceedings of NASA/JSC Conference”, March 1998; and SSP 41000 “System Specification for the International Space Station”, Table LXX, August 2014.
- Environmental Protection Agency (EPA) Maximum Contamination Level (MCL).
- If a compound has both a SWEG and EPA MCL, the SWEG value takes precedence.
- Garcia, H.D. et al., Establishment of Exposure Guidelines for Lead in Spacecraft Drinking Water. Aviat Space Envrion Med 2014; 85(7):715-720.



## Appendix H: Acceleration Limits Acceleration Coordinate System

Physiological Acceleration Nomenclature	Physiological Reaction Nomenclature
 <p>Anatomical axes x, y, z</p>	 <p>Anatomical axes x, y, z</p>
 <p>Linear Acceleration <math>a_x, a_y, a_z</math></p>	 <p>Linear Reaction <math>G_x, G_y, G_z</math></p>
 <p>Angular Acceleration <math>\alpha_x, \alpha_y, \alpha_z</math></p>	 <p>Angular Reaction <math>R_x, R_y, R_z</math></p>

**Figure H-1: Acceleration Environment Coordinate System**

**Table H-1: Direction and Inertial Resultant of Body Acceleration**

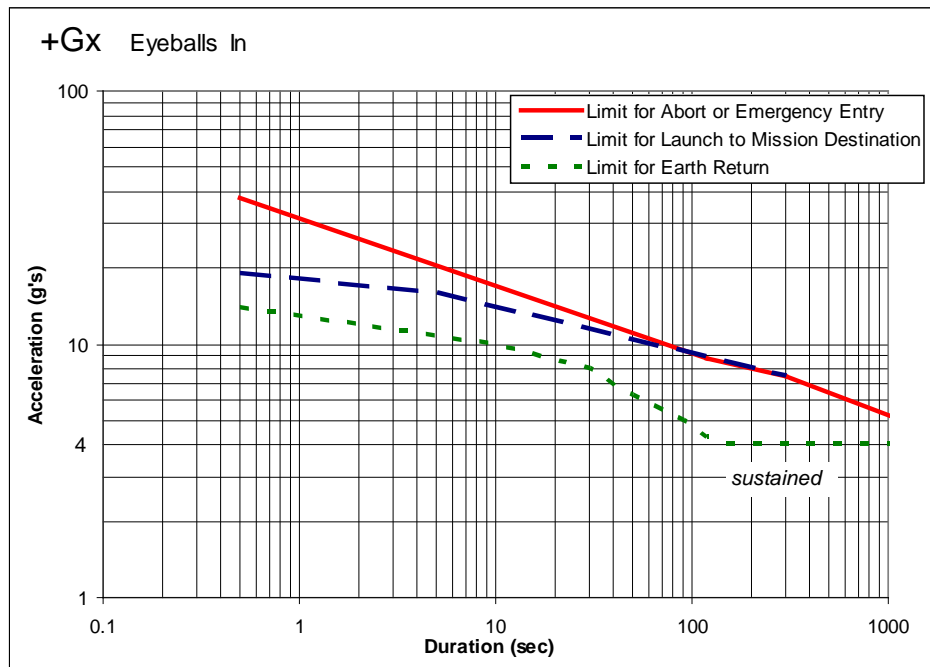
a. Direction of Acceleration			
Linear Motion	Aircraft Standard	Acceleration Description	
Forward	+a <sub>x</sub>	Forward acceleration	
Backward	-a <sub>x</sub>	Backward acceleration	
Upward	+a <sub>z</sub>	Headward acceleration	
Downward	-a <sub>z</sub>	Footward acceleration	
To the Right	-a <sub>y</sub>	Rightward acceleration	
To the Left	+a <sub>y</sub>	Leftward acceleration	

b. Inertial Resultant of Body Acceleration			
Linear Motion	Physiologic Descriptive	Physiologic Standard	Vernacular Descriptive
Forward	Transverse anterior-posterior G, prone G, chest to back G	+G <sub>x</sub>	Eyeballs-in
Backward	Transverse posterior-anterior G, supine G, back to chest G	-G <sub>x</sub>	Eyeballs-out
Upward	Positive G	+G <sub>z</sub>	Eyeballs-down
Downward	Negative G	-G <sub>z</sub>	Eyeballs-up
To the right	Lateral G	+G <sub>y</sub>	Eyeballs-left
To the left	Lateral G	-G <sub>y</sub>	Eyeballs-right

Note: G expresses inertial resultant to whole-body acceleration in multiples of the magnitude of the acceleration of gravity. Acceleration of gravity, g=9.80665 m/s<sup>2</sup>

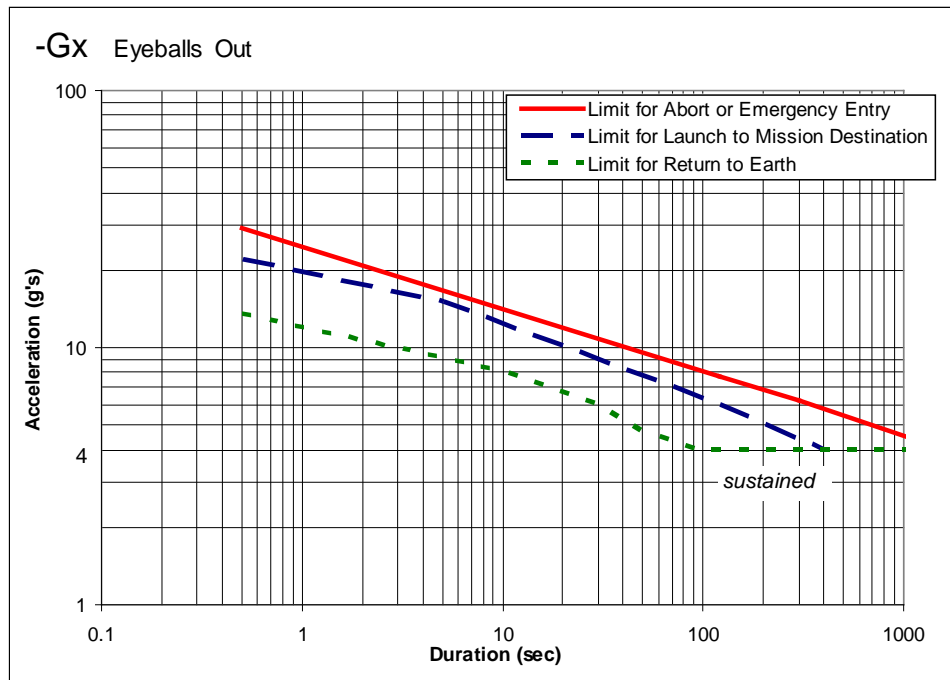
Sustained accelerations, linear or rotational, are events with a duration of greater than 0.5 seconds. Transient accelerations, linear or rotational, are events with a duration of less than or equal to 0.5 seconds.



**Figure H-2: +G<sub>x</sub> Sustained Translational Acceleration Limits**

**Data for Figure H-2**

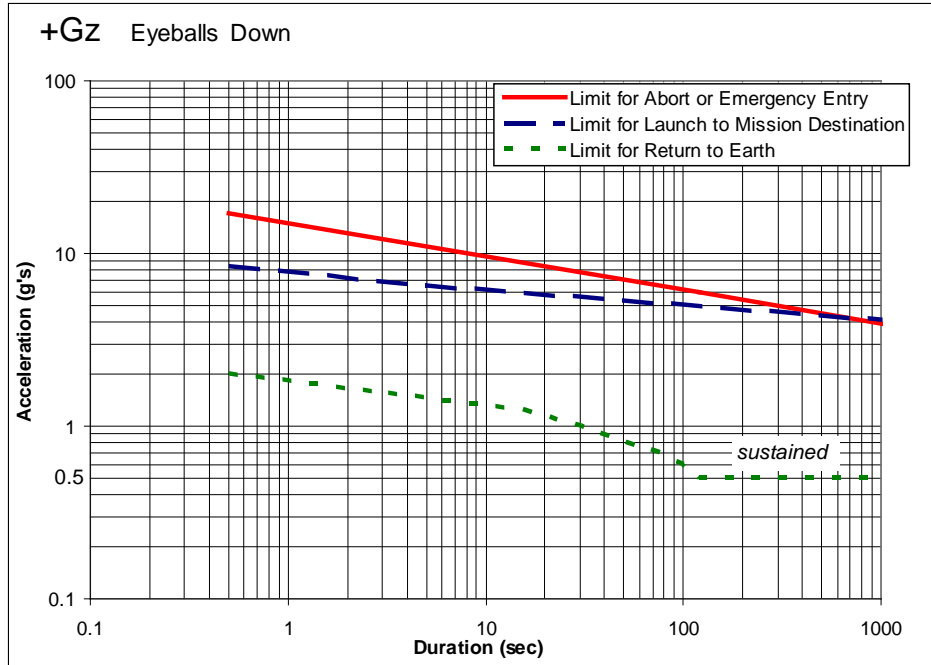
Return	Duration (sec)	0.5	10	30	50	90	120	150	10000
	Accel. (G's)	14	10	8	6.3	5	4.3	4	4
Launch	Duration (sec)	0.5	5	300					
	Accel. (G's)	19	16	7.5					
Emerg.	Duration (sec)	0.5	120	300	1200				
	Accel. (G's)	38	8.8	7.5	5				



**Figure H-3: -G<sub>x</sub> Sustained Translational Acceleration Limits**

**Data for Figure H-3**

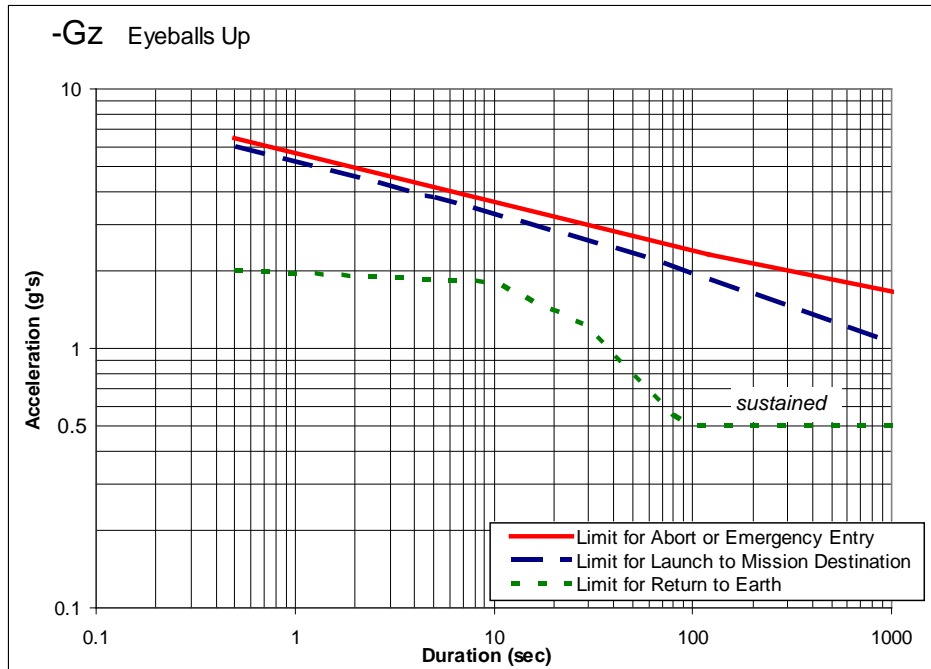
Return	Duration (sec)	0.5	10	30	50	90	100	100	10000
	Accel. (G's)	13.5	8	6	4.7	4.05	4	4	4
Launch	Duration (sec)	0.5	5	120	400				
	Accel. (G's)	22	15	6	4				
Emerg.	Duration (sec)	0.5	120	300	1200				
	Accel. (G's)	29	7.7	6.2	4.3				



**Figure H-4: +G<sub>z</sub> Sustained Translational Acceleration Limits**

**Data for Figure H-4**

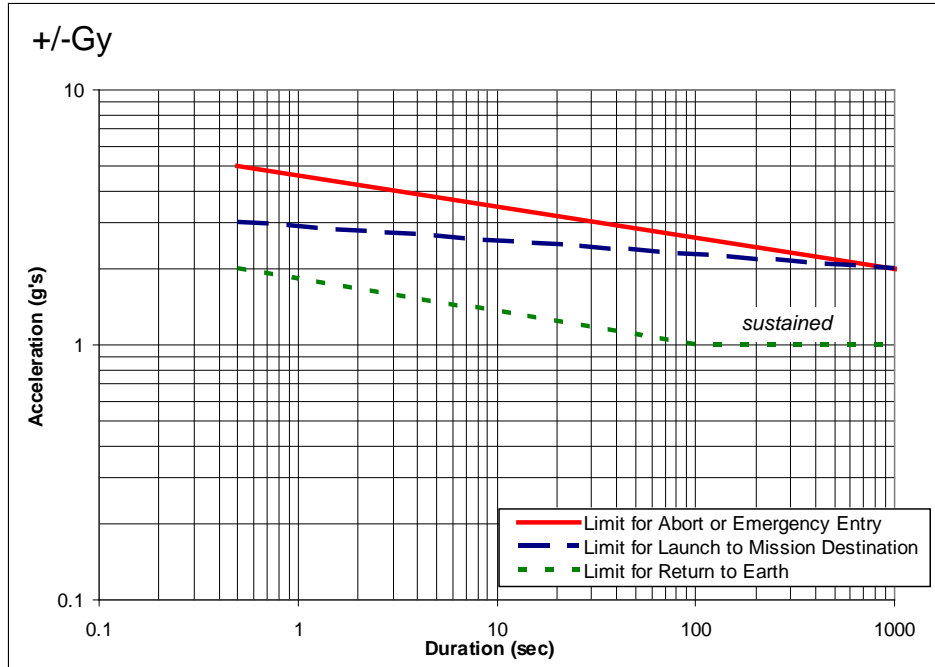
Return	Duration (sec)	0.5	15	30	50	80	100	120	10000
	Accel. (G's)	2	1.25	1	0.8	0.68	0.6	0.5	0.5
Launch	Duration (sec)	0.5	5	1200					
	Accel. (G's)	8.3	6.4	4					
Emerg.	Duration (sec)	0.5	120	1200					
	Accel. (G's)	17	6	3.8					



**Figure H-5: -G<sub>z</sub> Sustained Translational Acceleration Limits**

**Data for Figure H-5**

Return	Duration (sec)	0.5	10	30	50	80	100	120	10000
	Accel. (G's)	2	1.8	1.2	0.8	0.55	0.5	0.5	0.5
Launch	Duration (sec)	0.5	5	60	1200				
	Accel. (G's)	6	3.8	2.2	1				
Emerg.	Duration (sec)	0.5	120	1200					
	Accel. (G's)	6.5	2.3	1.6					



**Figure H-6: ±G<sub>y</sub> Sustained Translational Acceleration Limits**

**Data for Figure H-6**

Return	Duration (sec)	0.5	100	10000
	Accel. (G's)	2	1	1
Launch	Duration (sec)	0.5	1000	1000
	Accel. (G's)	3	2	2
Emerg.	Duration (sec)	0.5	1000	1000
	Accel. (G's)	5	2	2

## Appendix I: Radiation

### I.1 Retinal Thermal Injury from Visible and Near Infrared Sources

Requirements for limiting crew exposure to the electromagnetic spectrum from the ultraviolet (180 nm) to the far infrared (3,000 nm) are derived from the methodology given in the American Conference of Governmental Industrial Hygienists (ACGIH) standard, Threshold Limit Values (R) and Biological Exposure Indices®, Sections "Light and Near-Infrared Radiation" and "Ultraviolet Radiation." This methodology allows for the quantification of the relationship between source strength and acceptable exposure times for each of four potential injury pathways (retinal thermal injury caused by exposure to visible light, retinal photochemical injury caused by chronic exposure to blue-light, thermal injury to the ocular lens and cornea caused by infrared exposure, and exposure of the unprotected skin or eye to ultraviolet radiation). These limits do not apply to laser exposure. The numerical values used by the ACGIH are amended for use by NASA by the insertion of a factor of 0.2 in the source term of each calculation with the exception of ultraviolet exposure, which is not amended. This removes the excessive margin of safety imposed by the ACGIH on general populations.

The system shall limit exposure of the crew to spectral radiance  $L\lambda$  at wavelengths between 385 and 1,400 nm such that:

$$0.2 \sum_{385}^{1400} \{L_{\lambda} R(\lambda) \Delta\lambda\} \leq \frac{5}{\alpha t^{1/4}}$$

where,  $L\lambda$  is the source spectral radiance in  $W/(cm^2 \cdot sr \cdot nm)$ ,  $R(\lambda)$  is the Retinal Thermal Hazard Function given in Table I-1, where  $t$  is the viewing duration in seconds, and  $\alpha$  is the angular subtense of the source in radians.

**Table I-1: Blue-Light and Retinal Thermal Hazard Functions**

Wavelength (nm)	Blue-Light Hazard Function, $B(\lambda)$	Retinal Thermal Hazard Function, $R(\lambda)$
305-335	0.01	-
340	0.01	-
345	0.01	-
350	0.01	-
355	0.01	-
360	0.01	-
365	0.01	-
370	0.01	-
375	0.01	-
380	0.01	0.01
385	0.0125	0.0125



<b>Wavelength (nm)</b>	<b>Blue-Light Hazard Function, B(<math>\lambda</math>)</b>	<b>Retinal Thermal Hazard Function, R(<math>\lambda</math>)</b>
390	0.025	0.025
395	0.050	0.050
400	0.100	0.100
405	0.200	0.200
410	0.400	0.400
415	0.800	0.800
420	0.900	0.900
425	0.950	0.950
430	0.980	0.980
435	1.00	1.00
440	1.00	1.00
445	0.970	1.00
450	0.940	1.00
455	0.900	1.00
460	0.800	1.00
465	0.700	1.00
470	0.620	1.00
475	0.550	1.00
480	0.450	1.00
485	0.400	1.00
490	0.220	1.00
495	0.160	1.00
500	0.100	1.00
505	0.079	1.00
510	0.063	1.00
515	0.050	1.00
520	0.040	1.00
525	0.032	1.00
530	0.025	1.00
535	0.020	1.00
540	0.016	1.00
545	0.013	1.00
550	0.010	1.00

Wavelength (nm)	Blue-Light Hazard Function, B( $\lambda$ )	Retinal Thermal Hazard Function, R( $\lambda$ )
555	0.008	1.00
560	0.006	1.00
565	0.005	1.00
570	0.004	1.00
575	0.003	1.0
580	0.002	1.0
585	0.002	1.0
590	0.001	1.0
595	0.001	1.0
600-700	0.001	1.0
700-1050	-	$10^{[(700-\lambda)/500]}$
1050-1400	-	0.2

### I.2 Small Source Visible Radiation Limits

The system shall limit the spectral irradiance  $E_\lambda$  of the crew at wavelengths between 305 and 700 nm for visible-light sources subtending an angle less than 11 milliradians, such that:

$$0.2 \sum_{305}^{700} \{E_\lambda t B(\lambda) \Delta \lambda\} \leq 10 \text{ mJ/cm}^2 \text{ for } t < 10^4 \text{ s}$$

or

$$0.2 \sum_{305}^{700} \{E_\lambda B(\lambda) \Delta \lambda\} \leq 1 \text{ } \mu\text{W/cm}^2 \text{ for } t > 10^4 \text{ s}$$

where  $B(\lambda)$  is the blue-light hazard function given in Table I-1.

### I.3 Large Source Visible Radiation Limits

The system shall limit the exposure of the crew to spectral radiance  $L_\lambda$  at wavelengths between 305 and 700 nm for visible light sources subtending an angle greater than or equal to 11 milliradians, such that:

$$0.2 \sum_{305}^{700} \{L_\lambda t B(\lambda) \Delta \lambda\} \leq 100 \text{ J/(cm}^2 \cdot \text{sr)} \text{ for } t \leq 10^4 \text{ s}$$

or

$$0.2 \sum_{305}^{700} \{L_\lambda B(\lambda) \Delta \lambda\} \leq 10^{-2} \text{ W/(cm}^2 \cdot \text{sr)} \text{ for } t > 10^4 \text{ s}$$

where  $B(\lambda)$  is the blue-light hazard function given in Table I-1.

#### I.4 Thermal Injury from Infrared Radiation

The system shall limit the spectral irradiance  $E_\lambda$  of the crew at wavelengths between 770 and 3,000 nm to 10 mW/cm<sup>2</sup> for exposure durations longer than 1,000 seconds, and for exposure durations less than 1,000 seconds such that:

$$0.2 \sum_{770}^{3000} \{E_\lambda \Delta\lambda\} \leq 1.8 t^{-3/4} \quad W/cm^2$$

*Note:* The Threshold Limit Values (TLVs) apply to an environment with an ambient temperature of 37 °C, and can be increased by 0.8 mW/cm<sup>2</sup> for every whole degree below 37 °C.

#### I.5 Ultraviolet Exposure for Unprotected Eye or Skin

The system shall limit the spectral irradiance  $E_\lambda$  of the crew at wavelengths between 180 and 400 nm weighted by the spectral effectiveness function  $S_\lambda$  (given in Table I-2) to:

$$\sum_{180}^{400} \{E_\lambda S_\lambda t \Delta\lambda\} \leq 3 \text{ mJ/cm}^2 \quad \text{in any 24 hr period}$$

A table of weighted spectral irradiances versus permissible exposure times is given in Table I-3

**Table I-2: UV Radiation Exposure TLV and Spectral Weighting Function**

Wavelength (nm)	TLV (J/m <sup>2</sup> )	TLV(mJ/cm <sup>2</sup> )	Relative Spectral Effectiveness, $S_\lambda$
180	2500	250	0.012
190	1600	160	0.019
200	1000	100	0.030
205	590	59	0.051
210	400	40	0.075
215	320	32	0.095
220	250	25	0.120
225	200	20	0.150
230	160	16	0.190
235	130	13	0.240
240	100	10	0.300
245	83	8.3	0.360
250	70	7.0	0.430
255	58	5.8	0.520
260	46	4.6	0.650
265	37	3.7	0.810
270	30	3.0	1.000
275	31	3.1	0.960

Wavelength (nm)	TLV (J/m <sup>2</sup> )	TLV(mJ/cm <sup>2</sup> )	Relative Spectral Effectiveness, $S_{\lambda}$
280	34	3.4	0.880
285	39	3.9	0.770
290	47	4.7	0.640
295	56	5.6	0.540
300	100	10	0.300
305	500	50	0.06
310	2000	200	0.015
315	1.0*10 <sup>4</sup>	1000	0.003
320	2.9*10 <sup>4</sup>	2900	0.0024
325	6.0*10 <sup>4</sup>	6000	0.00050
330	7.3*10 <sup>4</sup>	7300	0.00041
335	8.8*10 <sup>4</sup>	8800	0.00034
340	1.1*10 <sup>5</sup>	1.1*10 <sup>4</sup>	0.00028
345	1.3*10 <sup>5</sup>	1.3*10 <sup>4</sup>	0.00024
350	1.5*10 <sup>5</sup>	1.5*10 <sup>4</sup>	0.00020
355	1.9*10 <sup>5</sup>	1.9*10 <sup>4</sup>	0.00016
360	2.3*10 <sup>5</sup>	2.3*10 <sup>4</sup>	0.00013
365	2.7*10 <sup>5</sup>	2.7*10 <sup>4</sup>	0.00011
370	3.2*10 <sup>5</sup>	3.2*10 <sup>4</sup>	0.000093
375	3.9*10 <sup>5</sup>	3.9*10 <sup>4</sup>	0.000077
380	4.7*10 <sup>5</sup>	4.7*10 <sup>4</sup>	0.000064
385	5.7*10 <sup>5</sup>	5.7*10 <sup>4</sup>	0.000053
390	6.8*10 <sup>5</sup>	6.8*10 <sup>4</sup>	0.000044
395	8.3*10 <sup>5</sup>	8.3*10 <sup>4</sup>	0.000036
400	1.0*10 <sup>6</sup>	1.0*10 <sup>5</sup>	0.000030

**Table I-3: Permissible Ultraviolet Exposures (200 - 400 NM)**

<b>Duration of Exposure per Day</b>	<b>Effective Irradiance, <math>\mu\text{W}/\text{cm}^2</math></b>
8 hrs.	0.1
4 hrs.	0.2
2 hrs.	0.4
1 hr.	0.8
30 min.	1.7
15 min.	3.3
10 min.	5
5 min.	10
1 min.	50
30 sec.	100
10 sec.	300
1 sec.	3000
0.5 sec.	6000
0.1 sec.	30000

## Appendix J: Reference NASA-Provided Supplies

Item	Total Mass (kg)	Total Volume (cc)	Minimum Dimensions to be Provided	Rationale
<b>Environmental Health Kit</b>	1.0	6240	40 cm x 26 cm x 6 cm (15.7 inch x 10.2 inch x 2.36 inch)	NASA will provide an environmental health kit for environmental monitoring hardware. It is anticipated that the hardware in this kit will include, but not be limited to: grab sample containers, high-rate dosimeters, and water sampling hardware. The stowage for this kit is not provided by NASA and is not included in the mass and volume.
<b>Food and Utensils</b>	1.69 kg fixed +1.52 kg /crew/day food	2962 cc fixed +5876 cc /crew/day food		NASA-provided food and utensils accounts for meals that would occur in all nominal and contingency scenarios (e.g. Delayed Rendezvous, Deorbit Waive-off). The crew's food is based on: the trip to ISS, the return from ISS, and the contingency days (Docking delay of 24 hours, safe haven of 6 hours and deorbit waive off of a minimum of 24 hours) for 4 crewmembers. The food system consists of a fixed mass for dining supplies (e.g. salt tablets and utensils) and the food with primary packaging. The food system also includes 12 salt tablets per crewmember, for each of two deorbit attempts, required for mitigating orthostatic intolerance on return. The stowage for the food and utensils is not provided by NASA and is not included in the mass and volume. The food is to be stored in a manner ensuring food quality and preventing puncture of packaging.

<b>Item</b>	<b>Total Mass (kg)</b>	<b>Total Volume (cc)</b>	<b>Minimum Dimensions to be Provided</b>	<b>Rationale</b>
<b>Contamination Cleanup Kit</b>	3.2	13,805	29.7 cm x 25.4 cm x 18.3 cm (11.7 inch x 10 inch x 7.2 inch)	In some onboard contamination events, such as a spill, vehicle systems may be unable to remove the contaminant in a physiologically relevant time-frame, and the crewmembers will have to perform the cleanup themselves or initiate operational steps to limit/reduce crew exposure in a more expedient time frame. The methods of contamination cleanup are a function of vehicle component materials, planned crew tasks which could result in contamination of the crew environment, and the capability of the ECLSS to maintain the environment. Examples of provisions include chemical and/or microbial wipes, toxic hazard labels and containment bags. The stowage for this kit is provided by NASA and is included in the mass and volume.
<b>Passive Radiation Area Monitors</b>	0.66	79.2	5.5 cm x 3.0 cm x 0.8 cm (2.17 in x 1.18 in x 0.31 in) each	Passive Radiation Area Monitors (RAMs) will be deployed pre-flight at a minimum of 6 designated fixed locations within the crew cabin. The total mass and volume are for 6 monitors. The RAMs complement the crew worn personal dosimeters. Knowledge of the spatial distribution of exposure rate is necessary to identify areas that have a relatively high exposure rate (i.e., avoidance areas) and to reconstruct a crewmember's exposure in the event of lost or unusable personal dosimeter data.
<b>Crew Personal Dosimeters</b>	0.4	N/A	N/A	The crew personal dosimeters are worn on each crew member. The total mass and volume are based on four crewmembers. The mass of each dosimeter is 0.1 kg.

Item	Total Mass (kg)	Total Volume (cc)	Minimum Dimensions to be Provided	Rationale
<b>Medical Kit</b>	3.0	6872	25.4 cm x 17.8 cm x 15.2 cm (10 inch x 7 inch x 6 inch)	The kit contents will support up to 4 NASA crewmembers for the duration of operating capability of the commercial vehicle in which the crew flies. It will, at a minimum, have medications and supplies to treat conditions such as, but not limited to: Space Adaptation Syndrome, urinary retention, corneal foreign body, minor pain, fatigue and alertness issues, initial treatment of allergic/anaphylactic reactions, upper respiratory congestion and pressure blocks and other common minor illnesses, and minor abrasions, cuts, and small joint sprains. This kit is separate from the ISS Medical Accessory Kit (IMAK) for medical support during ISS operations.
<b>ISS Medical Accessory Kit (IMAK)</b>	12	45,935.4	25.4 cm x 25.4 cm x 8.9 cm (10" x 10" x 3.5") each	IMAKs contain personal crew medical items that are required to be transported with crewmembers. Each NASA crewmember is allocated two IMAKs weighing up 1.5 kg each. Each crewmember must have access to their IMAKs during flights longer than 6 hours in duration to support unique medical conditions that may occur prior to docking.
<b>Crew Worn-On Items</b>	2.83	N/A	N/A	This includes kneeboard, flashlight, notebook, pen, and other miscellaneous items. These items will be worn on the crewmembers.
<b>ISS Crew Provisions</b>	35.11	145,520	5 Half CTBs (packed) 24.8cm x 42.5cm x 23.5cm (ea.)	This includes clothing, hygiene, crew preference items, camera and lens for fly-around photography, and miscellaneous items. Many of these items will be the same product that they will use on their 180 day stay on ISS.



## **Appendix K: Crew Range of Motion**

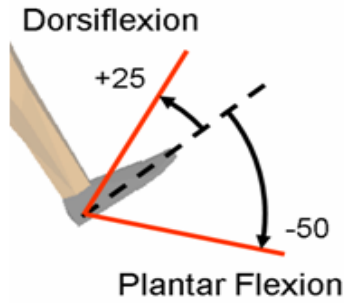
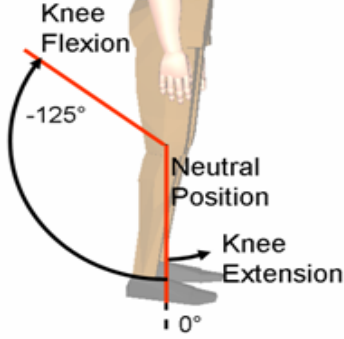

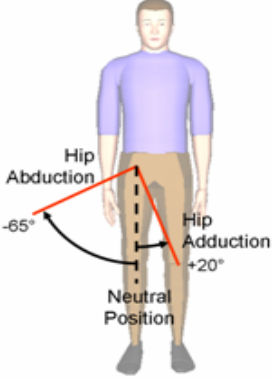
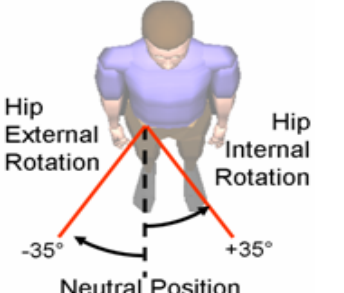
The ranges of motion to be accommodated for crewmembers were collected in 1 g under a variety of suited and unsuited conditions as part of a 2007/2008 study in the NASA JSC Anthropometry and Biomechanics Facility. The values represented in these tables show the level of mobility that was needed to perform a variety of relevant functional tasks. These numbers do not necessarily indicate maximum level of mobility possible in a given configuration. Each table provides the range of motion for specific suited and gravitational conditions as described below.

Table K-1 Range of Motion (Unsuited) provides several joint measures that were present in old versions of this table but were not reinvestigated as a part of the 2007/2008 mobility study. These values are specifically called out when listed in the table.

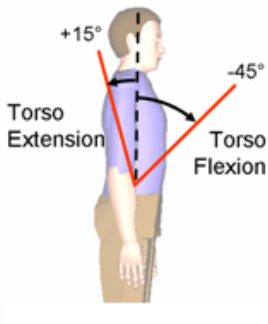
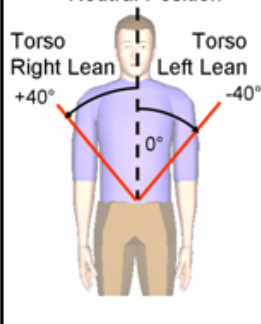
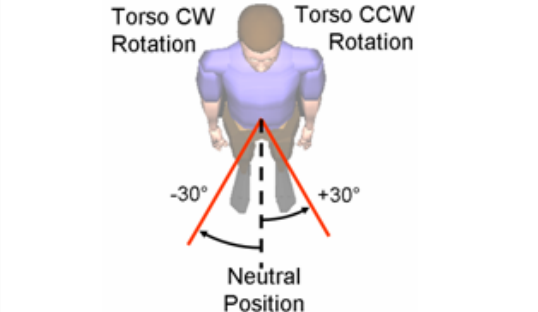
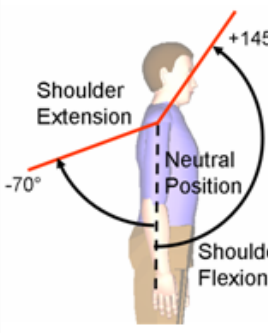
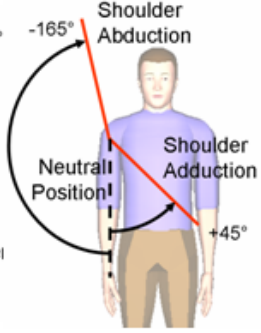
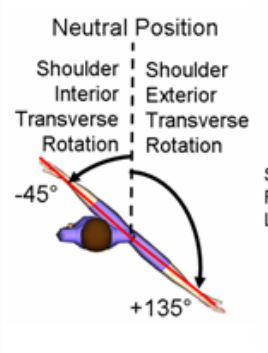

Table K-2 Range of Motion (Suited/ Unpressurized) represents unpressurized-suited mobility requirements for design of components such as cockpit controls, seat restraints, seat stowage, and all other interfaces used by a crewmember wearing a suit that is not actively pressurized.

Table K-3 Range of Motion (Suited/ Pressurized) represents pressurized-suited mobility requirements for design of components with which a crewmember will be expected to interact.

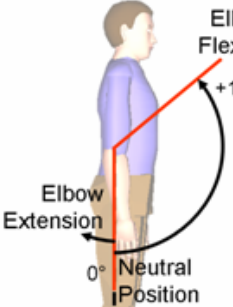
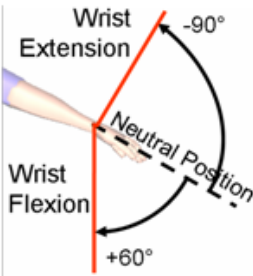
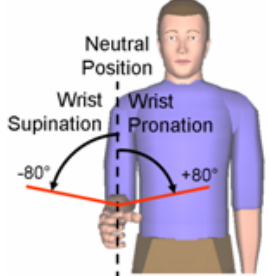

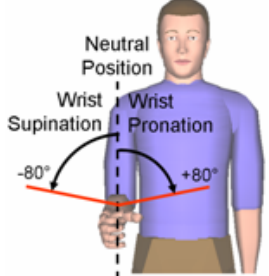
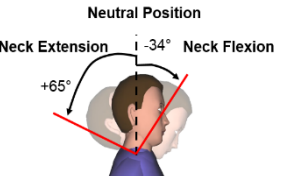
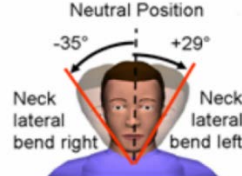
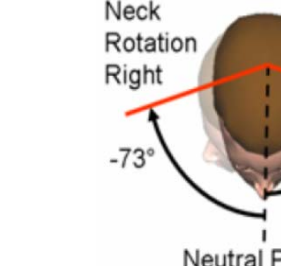
**Table K-1: Unsuit Range of Motion**  
(Page 1 of 4)

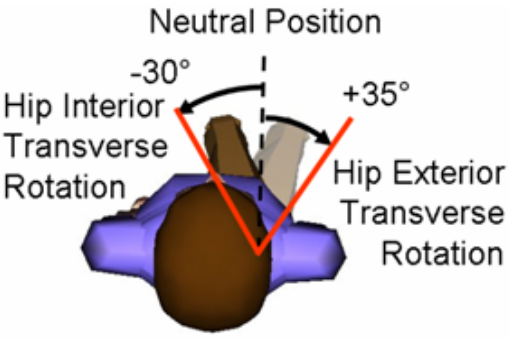
 <p>Dorsiflexion +25</p> <p>Plantar Flexion -50</p>	Ankle	<b>Unsuited ROM</b>	
		Dorsiflexion 25	Plantar Flex -50
		*All Units in Degrees	
 <p>Knee Flexion -125°</p> <p>Neutral Position</p> <p>Knee Extension 0°</p>	Knee	<b>Unsuited ROM</b>	
		Flexion -125	Extension 0
		*All Units in Degrees	
 <p>Hip Flexion +165°</p> <p>Hip Extension -15°</p> <p>Neutral Position 0°</p>	 <p>Hip Abduction -65°</p> <p>Hip Adduction +20°</p> <p>Neutral Position</p>	<b>Unsuited ROM</b>	
		Flexion 165	Extension -15
		Abduction -65	Adduction 20
 <p>Hip External Rotation -35°</p> <p>Hip Internal Rotation +35°</p> <p>Neutral Position</p>	Hip	Int Rotation 35	Ext Rotation -35
		*All Units in Degrees	

**Table K-1: Unsuitd Range of Motion**  
(Page 2 of 4)

 <p>Neutral Position +15° Torso Extension -45° Torso Flexion</p>	 <p>Neutral Position Torso Right Lean +40° Torso Left Lean -40° 0°</p>	<p><b>Torso</b></p>	<table border="1"> <thead> <tr> <th colspan="2">Unsuitd ROM</th> </tr> </thead> <tbody> <tr> <td>Flexion</td> <td>Extension</td> </tr> <tr> <td>-45</td> <td>15</td> </tr> <tr> <td>Right Lean</td> <td>Left Lean</td> </tr> <tr> <td>40</td> <td>-40</td> </tr> <tr> <td>CCW</td> <td>CW</td> </tr> <tr> <td>30</td> <td>-30</td> </tr> <tr> <td colspan="2">*All Units in Degrees</td> </tr> </tbody> </table>	Unsuitd ROM		Flexion	Extension	-45	15	Right Lean	Left Lean	40	-40	CCW	CW	30	-30	*All Units in Degrees	
Unsuitd ROM																			
Flexion	Extension																		
-45	15																		
Right Lean	Left Lean																		
40	-40																		
CCW	CW																		
30	-30																		
*All Units in Degrees																			
 <p>Torso CW Rotation -30° Torso CCW Rotation +30° Neutral Position</p>		<table border="1"> <thead> <tr> <th colspan="2">Unsuitd ROM</th> </tr> </thead> <tbody> <tr> <td>Flexion</td> <td>Extension</td> </tr> <tr> <td>145</td> <td>-70</td> </tr> <tr> <td>Abduction</td> <td>Adduction</td> </tr> <tr> <td>-165</td> <td>45</td> </tr> <tr> <td colspan="2">*All Units in Degrees</td> </tr> </tbody> </table>	Unsuitd ROM		Flexion	Extension	145	-70	Abduction	Adduction	-165	45	*All Units in Degrees						
Unsuitd ROM																			
Flexion	Extension																		
145	-70																		
Abduction	Adduction																		
-165	45																		
*All Units in Degrees																			
 <p>Shoulder Extension +145° Neutral Position -70° Shoulder Flexion</p>	 <p>Shoulder Abduction -165° Neutral Position Shoulder Adduction +45°</p>	<p><b>Shoulder</b></p>	<table border="1"> <thead> <tr> <th colspan="2">Unsuitd ROM</th> </tr> </thead> <tbody> <tr> <td>Interior Transverse Rotation</td> <td>Exterior Transverse Rotation</td> </tr> <tr> <td>-45</td> <td>135</td> </tr> <tr> <td>Lateral</td> <td>Medial</td> </tr> <tr> <td>-46</td> <td>91</td> </tr> <tr> <td colspan="2">*All Units in Degrees</td> </tr> </tbody> </table>	Unsuitd ROM		Interior Transverse Rotation	Exterior Transverse Rotation	-45	135	Lateral	Medial	-46	91	*All Units in Degrees					
Unsuitd ROM																			
Interior Transverse Rotation	Exterior Transverse Rotation																		
-45	135																		
Lateral	Medial																		
-46	91																		
*All Units in Degrees																			
 <p>Neutral Position Shoulder Interior Transverse Rotation -45° Shoulder Exterior Transverse Rotation +135°</p>	 <p>Neutral Position Shoulder Rotation Medial -46° Shoulder Rotation Lateral +91°</p>	<p><b>Shoulder 1979 Study</b></p>	<p>*All Units in Degrees</p>																

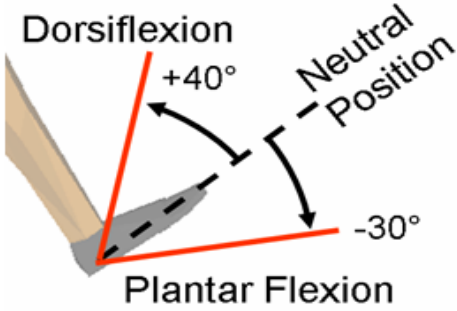
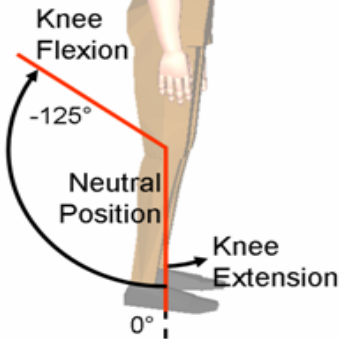
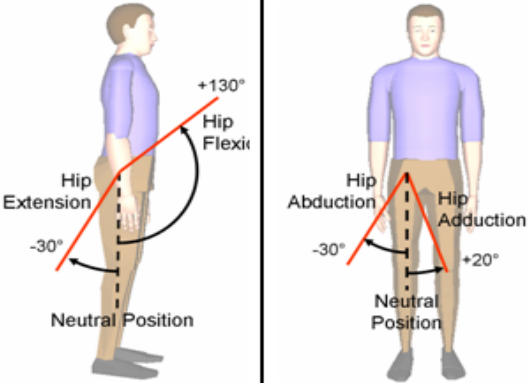
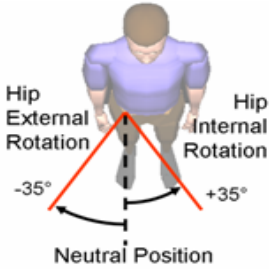
**Table K-1: Unsuitd Range of Motion**  
(Page 3 of 4)

	<p><b>Elbow</b></p>	<table border="1"> <thead> <tr> <th colspan="2">Unsuided ROM</th> </tr> </thead> <tbody> <tr> <td>Flexion</td> <td>Extension</td> </tr> <tr> <td>130</td> <td>0</td> </tr> <tr> <td colspan="2">*All Units in Degrees</td> </tr> </tbody> </table>	Unsuided ROM		Flexion	Extension	130	0	*All Units in Degrees			
Unsuided ROM												
Flexion	Extension											
130	0											
*All Units in Degrees												
		<table border="1"> <thead> <tr> <th colspan="2">Unsuided ROM</th> </tr> </thead> <tbody> <tr> <td>Extension</td> <td>Flexion</td> </tr> <tr> <td>-90</td> <td>60</td> </tr> </tbody> </table>	Unsuided ROM		Extension	Flexion	-90	60				
Unsuided ROM												
Extension	Flexion											
-90	60											
		<table border="1"> <tbody> <tr> <td>Abduction (Radial Deviation)</td> <td>Adduction (Ulnar Deviation)</td> </tr> <tr> <td>30</td> <td>-25</td> </tr> <tr> <td>Supination</td> <td>Pronation</td> </tr> <tr> <td>-80</td> <td>80</td> </tr> <tr> <td colspan="2">*All Units in Degrees</td> </tr> </tbody> </table>	Abduction (Radial Deviation)	Adduction (Ulnar Deviation)	30	-25	Supination	Pronation	-80	80	*All Units in Degrees	
Abduction (Radial Deviation)		Adduction (Ulnar Deviation)										
30	-25											
Supination	Pronation											
-80	80											
*All Units in Degrees												
		<table border="1"> <thead> <tr> <th colspan="2">Unsuided ROM</th> </tr> </thead> <tbody> <tr> <td>Flex</td> <td>Ex</td> </tr> <tr> <td>-34</td> <td>65</td> </tr> </tbody> </table>	Unsuided ROM		Flex	Ex	-34	65				
Unsuided ROM												
Flex	Ex											
-34	65											
	<p><b>Neck 1979 Study</b></p>	<table border="1"> <tbody> <tr> <td>Bend Right</td> <td>Bend Left</td> </tr> <tr> <td>-35</td> <td>29</td> </tr> <tr> <td>Rot R</td> <td>Rot L</td> </tr> <tr> <td>-73</td> <td>72</td> </tr> <tr> <td colspan="2">*All Units in Degrees</td> </tr> </tbody> </table>	Bend Right	Bend Left	-35	29	Rot R	Rot L	-73	72	*All Units in Degrees	
Bend Right		Bend Left										
-35	29											
Rot R	Rot L											
-73	72											
*All Units in Degrees												

 <p>Neutral Position</p> <p>-30°</p> <p>30°</p> <p>35°</p> <p>Hip Interior Transverse Rotation</p> <p>Hip Exterior Transverse Rotation</p>	<p>Hip 1979 Study</p>	<p><b>Unsuited ROM</b></p>	
		<p>Interior Transverse Rotation</p>	<p>Exterior Transverse Rotation</p>
		<p>-30</p>	<p>35</p>
		<p>*All Units in Degrees</p>	

“1979 Study” refers to data from SP-2-86L-064 Thornton, W, and Jackson, J. *Anthropometric Study of Astronaut Candidates, 1979 to 1980, (Unpublished Data) NASA-JSC.*

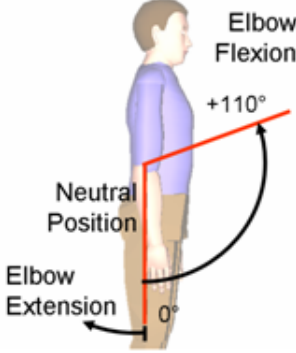
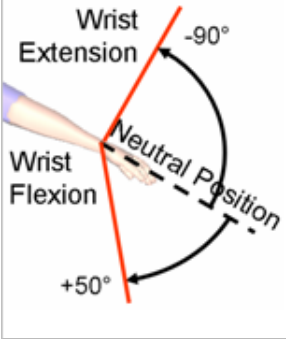
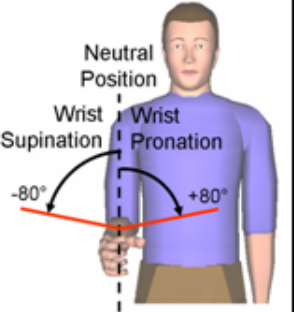
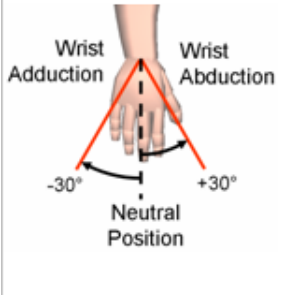
**Table K-2: Suited/Unpressurized Range of Motion  
(Page 1 of 3)**

	Ankle	Suited Unpressurized ROM						
<table border="1"> <tr> <td>Dorsiflexion</td> <td>Plantar Flex</td> </tr> <tr> <td>40</td> <td>-30</td> </tr> <tr> <td colspan="2">*All Units in Degrees</td> </tr> </table>		Dorsiflexion	Plantar Flex	40	-30	*All Units in Degrees		
Dorsiflexion	Plantar Flex							
40	-30							
*All Units in Degrees								
	Knee	Suited Unpressurized ROM						
<table border="1"> <tr> <td>Flexion</td> <td>Extension</td> </tr> <tr> <td>-125</td> <td>0</td> </tr> <tr> <td colspan="2">*All Units in Degrees</td> </tr> </table>		Flexion	Extension	-125	0	*All Units in Degrees		
Flexion	Extension							
-125	0							
*All Units in Degrees								
	Hip	Suited Unpressurized ROM						
<table border="1"> <tr> <td>Flexion</td> <td>Extension</td> </tr> <tr> <td>130</td> <td>-30</td> </tr> </table>		Flexion	Extension	130	-30			
Flexion		Extension						
130	-30							
<table border="1"> <tr> <td>Abduction</td> <td>Adduction</td> </tr> <tr> <td>-30</td> <td>20</td> </tr> </table>		Abduction	Adduction	-30	20			
Abduction	Adduction							
-30	20							
	<table border="1"> <tr> <td>Int Rotation</td> <td>Ext Rotation</td> </tr> <tr> <td>35</td> <td>-35</td> </tr> <tr> <td colspan="2">*All Units in Degrees</td> </tr> </table>		Int Rotation	Ext Rotation	35	-35	*All Units in Degrees	
Int Rotation	Ext Rotation							
35	-35							
*All Units in Degrees								

**Table K-2: Suited/Unpressurized Range of Motion**  
(Page 2 of 3)

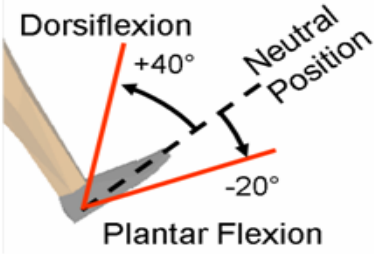
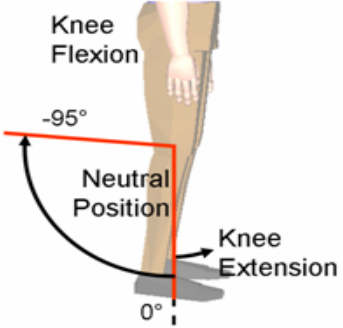

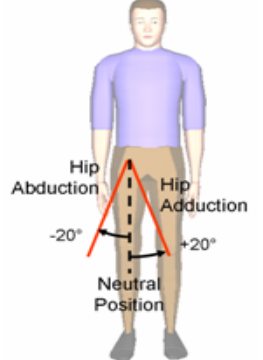
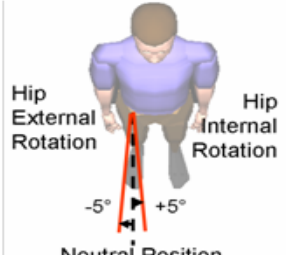
		<p><b>Torso</b></p>	<p><b>Suited Unpressurized ROM</b></p>					
			<table border="1"> <tr> <td>Flexion</td> <td>Extension</td> </tr> <tr> <td>-45</td> <td>15</td> </tr> </table>	Flexion	Extension	-45	15	
			Flexion	Extension				
		-45	15					
<table border="1"> <tr> <td>Right Lean</td> <td>Left Lean</td> </tr> <tr> <td>25</td> <td>-25</td> </tr> </table>	Right Lean	Left Lean	25	-25				
Right Lean	Left Lean							
25	-25							
<table border="1"> <tr> <td>CCW</td> <td>CW</td> </tr> <tr> <td>30</td> <td>-30</td> </tr> </table>	CCW	CW	30	-30				
CCW	CW							
30	-30							
		<p><b>Shoulder</b></p>	<p><b>Suited Unpressurized ROM</b></p>					
			<table border="1"> <tr> <td>Flexion</td> <td>Extension</td> </tr> <tr> <td>140</td> <td>-60</td> </tr> </table>	Flexion	Extension	140	-60	
			Flexion	Extension				
140	-60							
<table border="1"> <tr> <td>Ab</td> <td>Ad</td> </tr> <tr> <td>-120</td> <td>25</td> </tr> </table>	Ab	Ad	-120	25				
Ab	Ad							
-120	25							
		<p><b>Add'l Shoulder</b></p>	<p><b>Suited Unpressurized ROM</b></p>					
			<table border="1"> <tr> <td>Interior Transverse Rotation</td> <td>Exterior Transverse Rotation</td> </tr> <tr> <td>-25</td> <td>120</td> </tr> </table>	Interior Transverse Rotation	Exterior Transverse Rotation	-25	120	
			Interior Transverse Rotation	Exterior Transverse Rotation				
-25	120							
<table border="1"> <tr> <td>Lateral</td> <td>Medial</td> </tr> <tr> <td>-25</td> <td>60</td> </tr> </table>	Lateral	Medial	-25	60				
Lateral	Medial							
-25	60							
			<p>*All Units in Degrees</p>					

**Table K-2: Suited/Unpressurized Range of Motion  
(Page 3 of 3)**

	<b>Elbow</b>	<b>Suited Unpressurized ROM</b>				
<table border="1" style="width: 100%; border-collapse: collapse;"> <tr> <td style="width: 50%; text-align: center;">Flexion</td> <td style="width: 50%; text-align: center;">Extension</td> </tr> <tr> <td style="text-align: center;">110</td> <td style="text-align: center;">0</td> </tr> </table>		Flexion	Extension	110	0	
Flexion	Extension					
110	0					
*All Units in Degrees						
		<b>Suited Unpressurized ROM</b>				
<table border="1" style="width: 100%; border-collapse: collapse;"> <tr> <td style="width: 50%; text-align: center;">Extension</td> <td style="width: 50%; text-align: center;">Flexion</td> </tr> <tr> <td style="text-align: center;">-90</td> <td style="text-align: center;">50</td> </tr> </table>		Extension	Flexion	-90	50	
Extension	Flexion					
-90	50					
<table border="1" style="width: 100%; border-collapse: collapse;"> <tr> <td style="width: 50%; text-align: center;">Abduction (Radial Deviation)</td> <td style="width: 50%; text-align: center;">Adduction (Ulnar Deviation)</td> </tr> <tr> <td style="text-align: center;">30</td> <td style="text-align: center;">-30</td> </tr> </table>		Abduction (Radial Deviation)	Adduction (Ulnar Deviation)	30	-30	
Abduction (Radial Deviation)	Adduction (Ulnar Deviation)					
30	-30					
	<table border="1" style="width: 100%; border-collapse: collapse;"> <tr> <td style="width: 50%; text-align: center;">Supination</td> <td style="width: 50%; text-align: center;">Pronation</td> </tr> <tr> <td style="text-align: center;">-80</td> <td style="text-align: center;">80</td> </tr> </table>		Supination	Pronation	-80	80
Supination	Pronation					
-80	80					
*All Units in Degrees						



**Table K-3: Suited/Pressurized Range of Motion  
(Page 1 of 3)**

	Ankle	<b>Suited Pressurized ROM</b>				
<table border="1"> <tr> <td>Dorsiflexion</td> <td>Plantar Flex</td> </tr> <tr> <td>40</td> <td>-20</td> </tr> </table>		Dorsiflexion	Plantar Flex	40	-20	
Dorsiflexion	Plantar Flex					
40	-20					
*All Units in Degrees						
	Knee	<b>Suited Pressurized ROM</b>				
<table border="1"> <tr> <td>Flexion</td> <td>Extension</td> </tr> <tr> <td>-95</td> <td>0</td> </tr> </table>		Flexion	Extension	-95	0	
Flexion	Extension					
-95	0					
*All Units in Degrees						
		<b>Suited Pressurized ROM</b>				
<table border="1"> <tr> <td>Flexion</td> <td>Extension</td> </tr> <tr> <td>130</td> <td>-20</td> </tr> </table>		Flexion	Extension	130	-20	
Flexion	Extension					
130	-20					
<table border="1"> <tr> <td>Abduction</td> <td>Adduction</td> </tr> <tr> <td>-20</td> <td>20</td> </tr> </table>		Abduction	Adduction	-20	20	
Abduction	Adduction					
-20	20					
	<table border="1"> <tr> <td>Int Rotation</td> <td>Ext Rotation</td> </tr> <tr> <td>5</td> <td>-5</td> </tr> </table>		Int Rotation	Ext Rotation	5	-5
Int Rotation	Ext Rotation					
5	-5					
*All Units in Degrees						

**Table K-3: Suited/Pressurized Range of Motion  
(Page 2 of 3)**

		<p><b>Torso</b></p>	<p><b>Suited Pressurized ROM</b></p>					
			<table border="1"> <tr> <td>Flexion</td> <td>Extension</td> </tr> <tr> <td>0</td> <td>0</td> </tr> </table>	Flexion	Extension	0	0	
			Flexion	Extension				
			0	0				
			<table border="1"> <tr> <td>Right Lean</td> <td>Left Lean</td> </tr> <tr> <td>0</td> <td>0</td> </tr> </table>	Right Lean	Left Lean	0	0	
			Right Lean	Left Lean				
		0	0					
<table border="1"> <tr> <td>CCW</td> <td>CW</td> </tr> <tr> <td>0</td> <td>0</td> </tr> </table>	CCW	CW	0	0				
CCW	CW							
0	0							
<p>*All Units in Degrees</p>								
		<p><b>Shoulder</b></p>	<p><b>Suited Pressurized ROM</b></p>					
<p>*All Units in Degrees</p>			<table border="1"> <tr> <td>Flexion</td> <td>Extension</td> </tr> <tr> <td>115</td> <td>-10</td> </tr> </table>	Flexion	Extension	115	-10	
			Flexion	Extension				
			115	-10				
			<table border="1"> <tr> <td>Abduction</td> <td>Adduction</td> </tr> <tr> <td>-110</td> <td>0</td> </tr> </table>	Abduction	Adduction	-110	0	
			Abduction	Adduction				
		-110	0					
<p>*All Units in Degrees</p>								
		<p><b>Add'l Shoulder</b></p>	<p><b>Suited Pressurized ROM</b></p>					
<p>*All Units in Degrees</p>			<table border="1"> <tr> <td>Interior Transverse Rotation</td> <td>Exterior Transverse Rotation</td> </tr> <tr> <td>0</td> <td>120</td> </tr> </table>	Interior Transverse Rotation	Exterior Transverse Rotation	0	120	
			Interior Transverse Rotation	Exterior Transverse Rotation				
			0	120				
			<table border="1"> <tr> <td>Lateral</td> <td>Medial</td> </tr> <tr> <td>-25</td> <td>60</td> </tr> </table>	Lateral	Medial	-25	60	
			Lateral	Medial				
		-25	60					
<p>*All Units in Degrees</p>								

**Table K-3: Suited/Pressurized Range of Motion  
(Page 3 of 3)**

	<p style="text-align: center;"><b>Elbow</b></p>	<p style="text-align: center;"><b>Suited Pressurized ROM</b></p>					
<table border="1" style="width: 100%; border-collapse: collapse;"> <tr> <td style="width: 50%; text-align: center;">Flexion</td> <td style="width: 50%; text-align: center;">Extension</td> </tr> <tr> <td style="text-align: center;">120</td> <td style="text-align: center;">0</td> </tr> </table>		Flexion	Extension	120	0		
Flexion	Extension						
120	0						
<p>*All Units in Degrees</p>							
		<p style="text-align: center;"><b>Suited Pressurized ROM</b></p>					
<table border="1" style="width: 100%; border-collapse: collapse;"> <tr> <td style="width: 50%; text-align: center;">Extension</td> <td style="width: 50%; text-align: center;">Flexion</td> </tr> <tr> <td style="text-align: center;">-60</td> <td style="text-align: center;">50</td> </tr> </table>		Extension	Flexion	-60	50		
Extension	Flexion						
-60	50						
	<p style="text-align: center;"><b>Wrist</b></p>	<table border="1" style="width: 100%; border-collapse: collapse;"> <tr> <td style="width: 50%; text-align: center;">Abduction (Radial Deviation)</td> <td style="width: 50%; text-align: center;">Adduction (Ulnar Deviation)</td> </tr> <tr> <td style="text-align: center;">25</td> <td style="text-align: center;">-25</td> </tr> </table>		Abduction (Radial Deviation)	Adduction (Ulnar Deviation)	25	-25
Abduction (Radial Deviation)		Adduction (Ulnar Deviation)					
25	-25						
<table border="1" style="width: 100%; border-collapse: collapse;"> <tr> <td style="width: 50%; text-align: center;">Supination</td> <td style="width: 50%; text-align: center;">Pronation</td> </tr> <tr> <td style="text-align: center;">-80</td> <td style="text-align: center;">80</td> </tr> </table>		Supination	Pronation	-80	80		
Supination	Pronation						
-80	80						
<p>*All Units in Degrees</p>							

## Appendix L: Crew Interfaces

### L.1 Cooper-Harper Rating Scale

Reference information on use of the Cooper-Harper rating scale can be found in Section 4.6 of the JSC 65995 CHSIP.

Cooper-Harper Levels:

- Level 1 (HQR 1, 2, 3): Satisfactory without improvement
- Level 2 (HQR 4, 5, 6): Adequate performance, but deficiencies warrant improvement
- Level 3 (HQR 7, 8, 9): Improvement is required; performance and/or workload are unacceptable

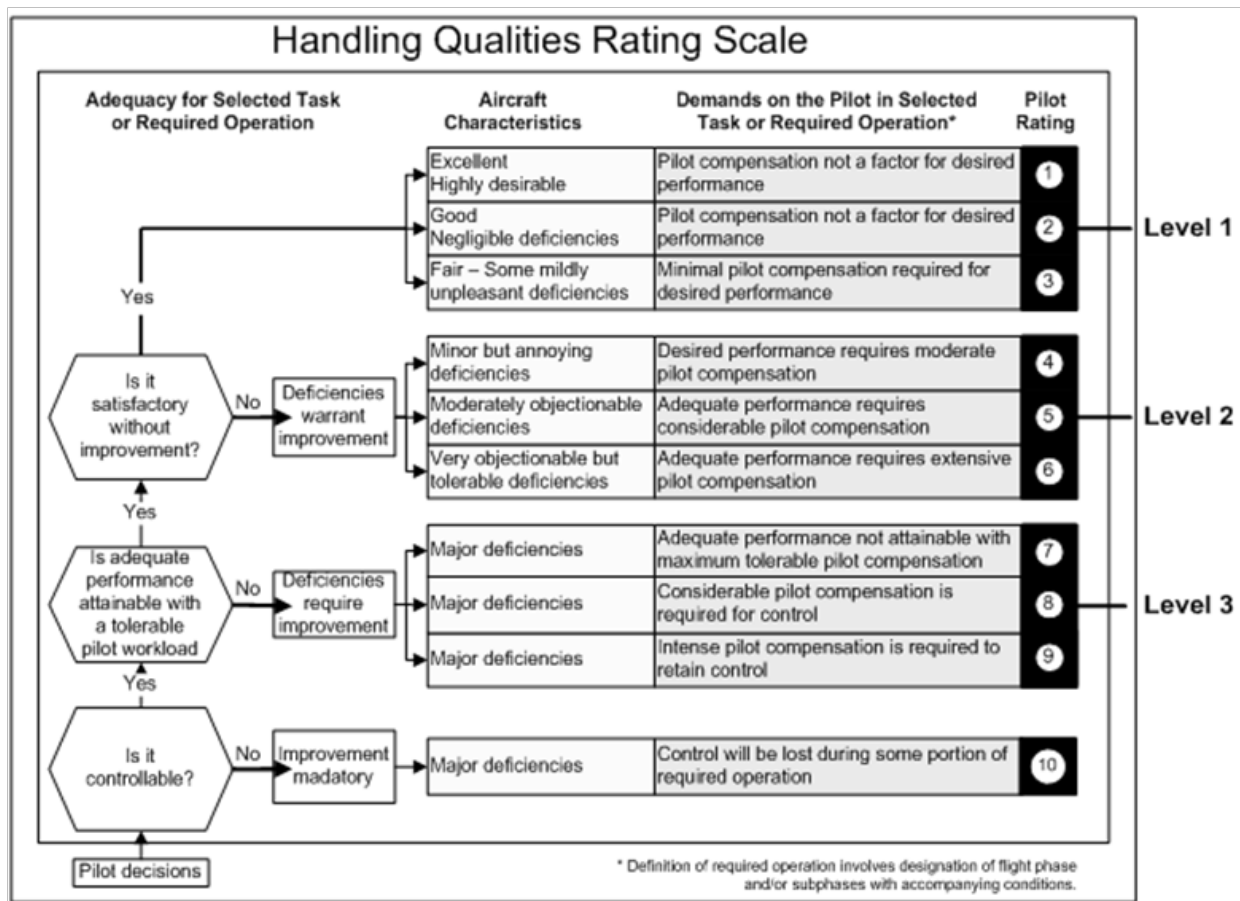


Figure L.1-1: Handling Qualities Rating Scale

**Table L.1-1: Input-Output Compatibility  
(Page 1 of 3)**

<b>Device</b>	<b>Direction of Movement and Result</b>
Knobs:	
Continuous and discrete position rotary	Turn clockwise with hand or fingers – turn function on, increase value, move discrete cursor right, move displayed page left Turn counterclockwise with hand or fingers – turn function off, decrease value, move discrete cursor left, move displayed page right
Ganged	Turn each individual knob clockwise with hand or fingers – turn function on, increase value, move discrete cursor right, move displayed page left Turn each individual knob counterclockwise with hand or fingers – turn function off, decrease value, move discrete cursor left, move displayed page right
Thumbwheels or scroll wheels (operated by brushing/turning the edge of the wheel):	
Vertical wheel orientation	Move thumbwheel/scroll wheel edge forward with thumb or finger – turn function on, increase value, move a discrete cursor up, move displayed page down Move thumbwheel/scroll wheel edge backward with thumb or finger – turn function off, decrease value, move a discrete cursor down, move displayed page up
Horizontal wheel orientation	Move thumbwheel/scroll wheel edge right with thumb or finger – turn function on, increase value, move a discrete cursor right, move displayed page left Move thumbwheel/scroll wheel edge left with thumb or finger – turn function off, decrease value, move a discrete cursor left, move displayed page right
Handwheels (operated by grasping the wheel's perimeter and turning) Note: Excludes valve wheels	Rotate handwheel clockwise with hand – turn function on, increase the value, move discrete cursor right, move displayed page left Rotate handwheel counterclockwise with hand – turn function off, decrease value, move discrete cursor left, move displayed page right
Pedals	Apply pressure to pedal with foot – turn function on, engage action, increase value. Reduce pressure to pedal with foot – turn function off, disengage action, decrease value
Momentary pushbuttons	Press and release to activate object or select menu item Press to activate function; release to deactivate function
Rocker switches:	

**Table L.1-1: Input-Output Compatibility  
(Page 2 of 3)**

<b>Device</b>	<b>Direction of Movement and Result</b>
Vertical rocker orientation	Depress upper wing with finger – turn function on, increase value, move discrete cursor up, move displayed page down Depress lower wing with finger – turn function off, decrease value, move discrete cursor down, move displayed page down
Horizontal switch orientation	Depress right wing with finger – turn function on, increase value, move discrete cursor right, move displayed page left Depress left wing with finger – turn function off, decrease value, move discrete cursor left, move displayed page right
Push-pull controls	Pull control with hand – turn function on Push control with hand – turn function off
<b>Slide/toggle switches:</b>	
Vertical switch orientation	Slide/flip switch forward with fingers – turn function on or increase value Slide/flip switch backward with fingers – turn function off or decrease value
Continuous cursor control devices (joystick, mouse, trackball, etc.)	Move device forward with hand – cursor moves up, displayed page moves down Move device backward with hand – cursor moves down, displayed page moves up Move device left with hand – cursor moves left, displayed page moves right Move device right with hand – cursor moves right, displayed page moves left Move device diagonally with hand in any direction – cursor moves diagonally in the same direction as the device's movement, displayed page moves diagonally opposite

**Table L.1-1: Input-Output Compatibility  
(Page 3 of 3)**

<b>Device</b>	<b>Direction of Movement and Result</b>
Discrete cursor control devices (arrow keys, castle switches)	Press/deflect up key, switch, or button with finger – cursor moves up, displayed page moves down Press/deflect down key, switch, or button with finger – cursor moves down, displayed page moves up Press/deflect right key, switch, or button with finger – cursor moves right, displayed page moves left Press/deflect left key, switch, or button with finger – cursor moves left, displayed page moves right (If diagonal capability exists) Press/deflect key, switch, or button diagonally with hand in any direction – cursor moves diagonally in the same direction as the device's movement; displayed page moves diagonally opposite
Rotational Hand Controller (RHC)	Pivot controller forward – pitch vehicle down Pivot controller backward – pitch vehicle up Pivot controller right – roll vehicle right Pivot controller left – roll vehicle left Rotate control clockwise with hand – yaw vehicle right Rotate control counterclockwise with hand – yaw vehicle left
Translational Hand Controller (THC)	Push in on control with hand – move vehicle forward Pull out on control with hand – move vehicle backward Push right on control with hand – move vehicle to the right Push left on control with hand – move vehicle to the left Push up on the control with hand – move vehicle up Push down on the control with hand – move vehicle down

NOTE: Movement directions are from the user's nominal perspective. When a control affects a cursor or an indicator on an electronic display, the control/display relationship of up and down movements may be dependent on the angle of the control mounting (with respect to the body and display) or on the prior experience of the user. The information in the table above assumes that the control is mounted in the horizontal plane and the display is in the vertical plane at roughly 90° to the body. Usability testing may be necessary to confirm the best mapping.

**L.2 RESERVED**

**L.3 System Usability Scale (SUS)**

System Usability Scale (SUS)	
	Strongly disagree <span style="float: right;">Strongly agree</span>
1. I think that I would like to use this system frequently	<input type="checkbox"/> 1 <input type="checkbox"/> 2 <input type="checkbox"/> 3 <input type="checkbox"/> 4 <input type="checkbox"/> 5
2. I found the system unnecessarily complex	<input type="checkbox"/> 1 <input type="checkbox"/> 2 <input type="checkbox"/> 3 <input type="checkbox"/> 4 <input type="checkbox"/> 5
3. I thought the system was easy to use	<input type="checkbox"/> 1 <input type="checkbox"/> 2 <input type="checkbox"/> 3 <input type="checkbox"/> 4 <input type="checkbox"/> 5
4. I think that I would need the support of a technical person to be able to use this system	<input type="checkbox"/> 1 <input type="checkbox"/> 2 <input type="checkbox"/> 3 <input type="checkbox"/> 4 <input type="checkbox"/> 5
5. I found the various functions in this system were well integrated	<input type="checkbox"/> 1 <input type="checkbox"/> 2 <input type="checkbox"/> 3 <input type="checkbox"/> 4 <input type="checkbox"/> 5
6. I thought there was too much inconsistency in this system	<input type="checkbox"/> 1 <input type="checkbox"/> 2 <input type="checkbox"/> 3 <input type="checkbox"/> 4 <input type="checkbox"/> 5
7. I would imagine that most people would learn to use this system very quickly	<input type="checkbox"/> 1 <input type="checkbox"/> 2 <input type="checkbox"/> 3 <input type="checkbox"/> 4 <input type="checkbox"/> 5
8. I found the system very cumbersome to use	<input type="checkbox"/> 1 <input type="checkbox"/> 2 <input type="checkbox"/> 3 <input type="checkbox"/> 4 <input type="checkbox"/> 5
9. I felt very confident using the system	<input type="checkbox"/> 1 <input type="checkbox"/> 2 <input type="checkbox"/> 3 <input type="checkbox"/> 4 <input type="checkbox"/> 5
10. I needed to learn a lot of things before I could get going with this system	<input type="checkbox"/> 1 <input type="checkbox"/> 2 <input type="checkbox"/> 3 <input type="checkbox"/> 4 <input type="checkbox"/> 5

**Figure L.3-1: System Usability Scale**



## **Appendix M:      RESERVED**

**Appendix N:        RESERVED**

## **Appendix O:      RESERVED**

## Appendix P: Reference Vehicle Endurance Timeline

The below timeline is a notional reference mission based upon specified operations and contingencies and estimated nominal operations. It illustrates how the operations integrate, but is not a requirement. The requirements are only levied in Section 3, but are cited here for reference.

**Table P-1: Mission Phases and Durations**

	<b>Requirement Paragraph</b>	<b>Required Operations</b>	<b>Hours</b>	<b>Comment</b>
<b>Nominal</b>	3.4.2.1	Liftoff thru docking	24	Protects 19 hours of phasing, allowing ~ 6 or more launch opportunities in 2 weeks.
		Hatch close to landing	No Dedicated Time Allocation Required	No requirement. Assume no fly-around
	3.5.1.4	Post-landing	2	Nominally 1 hour but with 1 hour margin
<b>Contingency</b>	3.4.2.3	24 hour Docking Delay	24	3 <sup>rd</sup> docking attempt on following crew day.
	3.4.2.2	- Contingency Docking	No Dedicated Time Allocation Required	2 <sup>nd</sup> attempt 90 min after initial docking attempt.
	3.1.5.2	- Port Relocation		Consumables not reserved. Use contingency redocking consumables as available.
	3.1.5.3	- Flyaround		Consumables not reserved. Use contingency redocking consumables as available.
	3.4.2.5	Safe Haven	6	ISS provides attitude control. Spacecraft provides power.
	3.4.2.5	- Safe Haven with ISS Power	(18)	ISS provides attitude control and power. Consumables not reserved. <u>Use contingency redocking consumables as available.</u>
	3.4.2.4	Deorbit Waive-off	24	Minimum of 24 hours of consumables are always reserved for a delay of the first planned deorbit. An alternate supported site exists within this timeframe. This capability extended if other contingencies do not occur.

(1) Additional life support consumables including consumables for each crewmember to utilize a quick don mask are required for:

- Feed a cabin leak for the time it takes to execute an emergency Deorbit (3.10.11.1.3)
- Depress and purge for a fire/toxic atmosphere if the design utilizes depress/purge/repress (3.10.11.1.2)

Only the larger of the two scenarios is required to be protected, per requirement 3.10.11.1.4. When executing an emergency deorbit while feeding the leak, additional deorbit waive-off consumables protection is no longer necessary.

(2) SSP 50808 Section 3.3.11.1.5 "Safe without ISS Services" must also be protected serially with the above table.

(3) Total mission endurance is architecture-dependent and may be driven by a mission scenario with a failure to dock, targeting a return to a supported landing site, followed by a 24 hour deorbit waive-off.

## Appendix Q: Human System Interface Design Requirements

The requirements in this section specify performance limits, component-level implementation, and design rules. These requirements reinforce higher-level parents called out in the body of CCT-REQ-1130, as depicted in Table Q.1-1. In many cases, verifying these component-level features reduces the scope (and potentially the cost) of the parent verifications. The Provider may flow these requirements directly into their design specification at the appropriate level, or offer a tailoring of the child, parent, or their verifications that will satisfy the need and generate commensurate objective evidence of compliance.

**Table Q.1-1: Parent-Child Traceability Matrix**

Parent Requirement Number	Name	Child Requirement Number	Name
3.2.2.2	Control Critical Hazards	Q.1.3	Impulse Noise Limit - Head
		Q.1.7	Pre-Launch Vibration Limit to Prevent Motion Sickness
		Q.2.1	Mechanical Hazards
		Q.2.2	Hot Temperature Hazards
		Q.2.4	Cold Temperature Hazards
		Q.2.5	Crew Control of Power
		Q.2.6	Electrical Hazard Potential
		Q.4.1	Captive Fasteners
3.2.5.3	Voice Communication in Breathing Apparatus	Q.6.3	Breathing Apparatus Annunciator Intelligibility
3.5.1.2 3.5.1.6 3.2.5.12	Assisted Vehicle Egress Crew Egress Paths Unassisted Vehicle Egress	Q.5.1	Crew Hatch Opening
		Q.5.2	External Hatch Opening
		Q.5.3	Hatch Operability
		Q.5.4	Hatch Cover Operations
		Q.5.5	Manual Pressure Equalization
		Q.5.6	Hatch Latch Indicator
		Q.5.7	Hatch Pressure Indicator
3.8.4.4	Windows for Crew Tasks	Q.3.11	Control Glare
		Q.5.8	Window Optical Properties
		Q.5.9	Window Frame Reflectance

<b>Parent Requirement Number</b>	<b>Name</b>	<b>Child Requirement Number</b>	<b>Name</b>
3.10.4.1 3.10.4.2 3.10.4.3 3.10.4.4	Crew Interface Usability Crew Interface Workload Operability of Controls Design Induced Crew Errors	Q.1.8	Workstation Illumination
		Q.3.1	Use of Color
		Q.3.2	Data Availability
		Q.3.3	Display Area for Task Support
		Q.3.4	Design of Controls
		Q.3.5	Control Labeling
		Q.3.6	Control Coding
		Q.3.7	High-g Control Configuration
		Q.3.8	Moderate-g Control Configuration
		Q.3.9	Control Activation Indication
		Q.3.10	Interface Legibility
Q.3.11	Control Glare		
3.10.4.5	Emergency Annunciations	Q.6.2	Loudspeaker Sound Limits
3.10.4.7	Protect for Inadvertent Operation	Q.1.8	Workstation Illumination
		Q.3.1	Use of Color
		Q.3.2	Data Availability
		Q.3.3	Display Area for Task Support
		Q.3.4	Design of Controls
		Q.3.5	Control Labeling
		Q.3.6	Control Coding
		Q.3.7	High-g Control Configuration
		Q.3.8	Moderate-g Control Configuration
		Q.3.9	Control Activation Indication
		Q.3.10	Interface Legibility
		Q.3.11	Control Glare
		Q.5.4	Hatch Cover Operations

<b>Parent Requirement Number</b>	<b>Name</b>	<b>Child Requirement Number</b>	<b>Name</b>
3.10.5.2.1	Noise level for Communication	Q.1.2	Intermittent Noise Limit
		Q.1.5	Narrow-band SPL
		Q.6.1	Audio Volume Control
3.10.14.1	Hatch Bi-directional Operability	Q.5.1	Crew Hatch Opening
		Q.5.2	External Hatch Opening
		Q.5.3	Hatch Operability
		Q.5.4	Hatch Cover Operations
		Q.5.5	Manual Pressure Equalization
		Q.5.6	Hatch Latch Indicator
		Q.5.7	Hatch Pressure Indicator
3.10.14.2	Hatch Windows	Q.3.11	Control Glare
		Q.5.8	Window Optical Properties
		Q.5.9	Window Frame Reflectance
3.10.17.2	Sleep Accommodations	Q.1.4	Noise during Sleep
		Q.1.6	Vibration Limits during Crew Sleep
		Q.1.9	Light Limits for Crew Sleep
3.10.20.2	Habitable Space Sizing	Q.4.2	Stowage Locations
		Q.4.3	Location Coding
		Q.4.4	Crew Restraints and Mobility Aids



**Q.1: Crew Environment**

**Q.1.1 RESERVED**

**Q.1.1V RESERVED**

**Q.1.2 Intermittent Noise Limit**

The CTS shall limit intermittent A-weighted overall SPL emissions from noise sources that operate for 8 hours or less measured 0.6 m from the loudest point on the hardware, to the levels and nominal durations in Table Q.1.2-1 or less, over any 24-hour period during all mission phases except launch and entry. Note: This requirement does not apply to impulse noise. [R.CTS.233]

*Rationale: To provide for adequate speech intelligibility and habitability, levels in Table Q.1.2-1, "Intermittent Noise A-Weighted Overall Sound Pressure Level and Corresponding Durational Duration Limits (Measured at 0.6 M)" will limit intermittent noise levels of specific hardware items that are inherently noisy and operate for a short time period where alternative means for noise control are prohibitively expensive or impractical. Durations associated with contingencies need not be used to define the noise level. The nominal duration will be used to determine the appropriate noise level. These sound level and operational duration limits are taken from ISS requirements (SSP 57000, Pressurized Payload Interface Requirements Document).*

**Table Q.1.2-1: Intermittent Noise A-Weighted Overall Sound Pressure Level and Corresponding Operational Duration Limits (Measured at 0.6 M)**

<b>Maximum Noise Duration Per 24-hour Period</b>	<b>LA<sub>max</sub> (dBA re 20 µPa)</b>
8 Hours	≤ 49
7 Hours	≤ 50
6 Hours	≤ 51
5 Hours	≤ 52
4.5 Hours	≤ 53
4 Hours	≤ 54
3.5 Hours	≤ 55
3 Hours	≤ 57
2.5 Hours	≤ 58
2 Hours	≤ 60
1.5 Hours	≤ 62
1 Hour*	≤ 65
30 Minutes*	≤ 69

15 Minutes*	≤ 72
5 Minutes*	≤ 76
2 Minutes*	≤ 78
1 Minute*	≤ 79
Not Allowed	≥ 80

**\*Applies only to noise sources that are crew-operated or that have 3 or less activations per day.**

**Q.1.2V** The CTS's intermittent noise shall be verified by test and analysis. Hardware qualifying for verification using this requirement shall meet Q.1.4 requirements. SPL measurements shall be made of the actual flight hardware in its flight configuration with closeouts installed. Hardware shall be operated across the expected range of settings, including settings corresponding to the expected highest noise levels. Analysis shall be used to include any measured acoustical effects of the hardware installation configuration or to combine measured sound pressure levels of hardware items that must be operated simultaneously when these factors are not accurately represented in field tests. If the noise generated by a specific hardware item is influenced by the operation of another hardware item, then these hardware items shall be tested together. Analysis shall also be used to calculate the maximum operational duration to include the total time during any 24-hour period that the hardware item operates above the continuous noise limits given in requirement 3.10.5.2.1. This verification shall be considered successful when the test and analysis (and any performed simulations) indicates that the maximum noise level for the duration of intermittent operation, measured 0.6 m from the loudest point on the hardware surface, meets the level and duration limits specified in Table Q.1.2-1. [V.CTS.233]

### **Q.1.3 Impulse Noise Limit - Head**

The CTS shall limit impulse noise, measured at the crewmember's head location, to less than 140 dB peak SPL during all mission phases, except launch and entry. [R.CTS.234]

*Rationale: A limit of 140 dB peak SPL for impulse noise will prevent acoustic trauma (reference MIL-STD-1474D).*

**Q.1.3V** The CTS's impulse noise limit shall be verified by test. The SPL measurements for this verification shall be made using the actual flight equipment. Formal verification is not required for equipment with impulse noises that have peak overall SPLs of less than 110 dB. Peak-hold sound pressure level measurements shall be made using a Type 1 sound level meter on all equipment that emits significant impulse noise at expected head locations. The frequency response of the sound level meter shall extend to at least 6 Hz at its lower limit. Measurement locations relative to specific noise sources must correspond to the shortest distance from the loudest point on the hardware to the closest possible crewmember head location. This verification shall be considered successful when the test results show that the peak overall sound pressure level measurements are less than 140 dB. [V.CTS.234]

### **Q.1.4 Noise during Sleep**

The CTS shall limit impulse and intermittent noise levels at the crewmember's head location to 10 dB above NC-50 during crew sleep periods. Note: Communications and alarms do not need to meet this requirement. [R.CTS.235]

*Rationale: Impulse and intermittent noise must be limited to less than 10 dB above the background noise to avoid waking crewmembers who are sleeping.*

**Q.1.4V** The CTS's impulse and intermittent annoyance noise limit shall be verified by test. The measurements shall be made within the vehicle in the flight configuration. Hardware shall be operated at settings that occur during crew rest periods. Measurements shall be made at expected sleep station head locations. Measurement locations shall be no closer than 8 cm from any surface. Peak-hold sound pressure level measurements shall be made. The verification shall be considered successful when the test shows that the peak overall sound pressure levels are less than 10 dB above NC-50 during crew sleep periods. [V.CTS.235]

### **Q.1.5      Narrow-band SPL**

The CTS shall limit the maximum SPL of narrow-band noise components and tones to at least 10 dB less than the broadband SPL of the octave band that contains the component or tone. [R.CTS.236]

*Rationale: Limiting narrow band noise component and tone levels to 10 dB below the broadband level will prevent irritating and distracting acoustic conditions that could affect crew performance.*

**Q.1.5V** The tonal and narrow-band noise limit shall be verified by test. The measurements shall be made within the spacecraft in the flight configuration with integrated portable equipment, stowage, spacecraft installations, and closeouts installed. Hardware shall be operated across the expected range of operational settings (including settings corresponding to the expected highest noise levels). Equivalent-continuous sound level, Leq, measurements shall be made within each octave band with a 20-second averaging time. Tonal and narrow-band component measurements shall also be made using a Fast Fourier Transform (FFT) with a frequency resolution of 1 Hz. Measurements shall be made at expected work and sleep station head locations. The verification shall be considered successful when the test indicates that the maximum levels of tones and narrow band components, measured at all work and sleep station head locations, is at least 10 dB less than the NC-50 value in Figure Q.1.1-1, "NC Curves" and Table Q.1.1-1, "Octave Band SPL Limits for Continuous Noise" of the octave band that contains the component or tone. [V.CTS.236]

### **Q.1.6      Vibration Limits during Crew Sleep**

The CTS shall limit vibration to the crew such that the frequency-weighted acceleration between 1.0 and 80 Hz in each of the X, Y, and Z axes is less than 0.01 g rms for each 2-minute interval during an 8-hour crew sleep period. [R.CTS.222]

*Rationale: For long-duration exposure (~8.5 hours), smaller vibrations to which the crew is exposed can adversely affect crew sleep. International Standards Organization (ISO) 6954:2000, Mechanical Vibration Guidelines for the Measurement, Reporting and Evaluation of Vibration with Regard to Habitability on Passenger and Merchant Ships, provides vibration*

*exposure guidelines for habitability onboard passenger and merchant ships to include sleep areas and reflects the occupant perception of the vibration in these areas. ISO-6954:2000, Section 7 states that vibration of 0.01 g rms or lower for crew accommodation areas in ships is not likely to draw adverse comments from occupants.*

**Q.1.6V** The crew sleep vibration limit requirement shall be verified by analysis. The analysis shall consider all possible sources of vibration during the onorbit phase. The analysis shall reflect the average acceleration levels expected to occur during an 8-hour sleep period. The analysis profile shall comprise a simulation of crew compartment vibration. In accordance with ISO Standard 6954:2000, Section 6, the minimum estimate period shall be 2 minutes in case of significant vibration frequency content below 2 Hz. All acceleration estimates shall be weighted in accordance with ISO 6954:2000, Annex A using the frequency weighting  $W_a$  (Table A.1). The verification shall be considered successful when it is shown that the predicted vibration levels do not exceed the specified levels at the crew sleep station. [V.CTS.222]

### **Q.1.7 Pre-Launch Vibration Limit to Prevent Motion Sickness**

The CTS shall limit vibration to the crew such that the frequency-weighted acceleration between 0.1 to 0.5 Hz in each of the X, Y, and Z axes is less than 0.05 g rms for each 10-minute interval during the pre-launch timeframe. [R.CTS.223]

*Rationale: Low-frequency vibration, especially in the range between 0.1 and 0.5 Hz, has the potential to cause motion sickness over relatively short exposure periods. This may be encountered while the crew is in the vehicle during the pre-launch period, given that the tall vehicle stack may be susceptible to swaying back and forth. Reducing the amount of sway will prevent the onset of motion sickness during the pre-launch phase. For assessing vibration between 0.1 and 0.5 Hz, the Motion Sickness Dose Value (MSDV) is calculated in accordance with ISO 2631-1: 1997, Annex D, Equation D-1. Although the ISO 2631-1 limits the acceleration measurement for assessing motion sickness to the vertical direction, this is based on the assumption that the human is in the seated upright posture. Because the occupants of the subject vehicle will be in the semi-supine posture, the requirement is applied to all three orthogonal axes, X, Y, and Z. The purpose of the 10-minute integration time is to constrain the deviations around the permitted average sway during a 2-hour pre-launch period.*

**Q.1.7V** The pre-launch vibration limit shall be verified by analysis. The analysis shall consider all possible sources of vibration during the pre-launch phase after the crew is on-board. The weighted acceleration shall be calculated in accordance with ISO Standard 2631-1:1997 using the frequency weighting  $W_f$  applied in each X, Y, and Z direction (ISO Standard 2631-1:1997, Table 3). The verification shall be successful when the predicted vibration levels are below the specified limits for each representative 10-minute period of exposure. [V.CTS.223]

### **Q.1.8 Workstation Illumination**

The spacecraft shall illuminate crew workstations in accordance with Table Q.1.8-1. [R.CTS.201]

*Rationale: Lighting needs vary, depending on the crew activities, operations, and visual tasks being performed. The crew will likely need the ability to adjust lighting (on/off, control intensity*

*and/or angle) for many cockpit tasks. For example, rendezvous and proximity operations may require general cabin darkening for out-the-window viewing but sufficient lighting for crew translation and manual control. To perform tasks at a workstation, directed lighting or control/display backlighting may be needed so as not to interfere with adjacent or concurrent tasks. Glare may be reduced by adjusting light intensity or prevented by appropriate selection, positioning, or direction of light sources. A single type of lighting at a single illumination level is insufficient to support all tasks; therefore, both general and task illumination are necessary. Lighting design should consider human factors, such as light color, surface reflectance, and glare. Design guidance can be found in NASA/SP-2010-3407, Human Integration Design Handbook (HIDH). Guidance on task analysis process can be found in Section 4.1 of JSC 65995, CHSIP.*

Table Q.1.8-1 Spacecraft Illumination Levels

Area <sup>(1)</sup> or Task <sup>(1)</sup>	Lux <sup>(2)</sup>	Ft. C <sup>(2)</sup>
General	108	10
Passageways	54	5
Hatches	108	10
Handles	108	10
Ladders	108	10
Stowage Areas	108	10
Workstation	323	30
Maintenance	269	25
Controls	215	20
Assembly	323	30
Transcribing	538	50
Tabulating	538	50
Repair	323	30
Panels (Positive)	215	20
Panels (Negative)	54	5
Reading	538	50
Notes: (1) Levels are measured at the task object or 789 mm (30 in.) above floor, as applicable. (2) All levels are minimum.		

**Q.1.8V** Provisions for spacecraft interior lighting shall be verified through analysis and test. A crew task analysis shall be performed to determine crew tasks that require visual performance and identify workstations associated with those tasks. Test shall be performed using flight representative lighting system(s) and vehicle in the flight configuration. Illumination measurements are to be made on and normal to the task surface(s) with a subject positioned to perform the task. The verification shall be

considered successful when measurements show that illumination levels are within the ranges specified in table Q.1.8-1 to support expected crew tasks. [V.CTS.201]

### **Q.1.9 Light Limits for Crew Sleep**

The spacecraft shall reduce the cabin light to 2 lux or less at the head location during sleep periods. [R.CTS.181]

*Rationale: External illumination can interfere with spacecraft operations, such as crew sleep and circadian rhythm.*

**Q.1.9V** The provision of lowering the cabin light levels at the crewmembers' head location shall be verified by test. The test shall utilize an external light source whose illumination on the exterior of the windows shall be at least 132,000 lux on the largest of the windows directly facing the illumination source, while the majority of the rest of the system windows also face the illumination source to the maximum extent possible. There shall be no internal illumination sources present and the interior of the vehicle shall be completely darkened while the illumination near each window on the interior is measured. The verification shall be considered successful when the test shows that the spacecraft reduces the light level to 2 lux or less at the crewmembers head location. [V.CTS.181]

## **Q.2: Crew Hazard**

### **Q.2.1 Mechanical Hazards**

The CTS shall protect the crew from injury from:

- a) moving parts
- b) entrapment per SSP 50005 sections 6.3.3.4 and 6.3.3.5
- c) sharp edges per SSP 50005 sections 6.3.3.1, 6.3.3.2, 6.3.3.3, and 6.3.3.11
- d) sharp items
- e) burrs per SSP 50005 sections 6.3.3.9
- f) pinch points per SSP 50005 sections 6.3.3.8
- g) stored potential energy [R.CTS.248]

*Rationale: Hardware and equipment are to be designed to protect crewmembers from inadvertent contact with mechanical hazards, becoming trapped or snagged by fixed or loose items, and the release of stored energy.*

*Mechanical hazards include items, such as hatch gears, that may catch clothing or hair, or cause injury. Historically, protection methods, such as covers or closeout panels, have been used to minimize risk of hazards. Entrapment can occur in places where loose cables or other restraint devices, such as tethers, strap, or nets, float in translation paths or habitable volume; equipment items or deployed hardware block passageways; or where clothing or appendages become snagged, such as in holes. Entrapment can also occur when crewmembers are unable to unfasten motion restraints (seat belts and shoulder harnesses, foot restraints, tethers, etc.), which is especially a concern under time-critical conditions when they need to evacuate.*

*Sharp corners and edges in passageways, maintenance areas, stowage compartments, or workstations present hazardous conditions and are to be avoided. Also, hand-held items, such as tools, present a hazard to the crew. The force (and resulting damage) in contact with fixed items depends on the mass and speed of the crewmember. The damage from loose items, however, depends on the weight of the item. Therefore, the corners and edges of a loose item do not have to be as rounded as a fixed item. Although hand-held items are loose, they are squeezed, and forces can be high. Therefore, hand-held items are to meet the edge and corner rounding requirements of fixed items. Functionally sharp items are intentionally sharp (e.g., syringe, scissors, knives) and should be prevented from causing harm when not in nominal use. Removal of burrs can help to prevent personnel injury and damage to protective equipment from sharp edges during normal operations.*

*Pinch points can cause injury to the crew, but may exist for the nominal function of equipment (i.e., equipment panels). This may be avoided by locating pinch points out of the crew's reach or providing guards to eliminate the potential to cause injury. Equipment (e.g., cables, fluid lines,*

*air ducts, etc.) should also be protected from pinch points because damage to equipment may harm crew.*

*This requirement addresses stored potential energy sources other than pressurized vessels and lines, pyrotechnics, and batteries which are addressed by separate requirements that levy appropriate standards. Other components and systems that retain potentially injurious levels of stored potential energy, such as hatch mechanisms, or systems with large springs, must either be designed to prevent a crewmember from unintentionally releasing the stored potential energy or be designed with provisions to allow safing of the potential energy including provisions to confirm that the safing was successful.*

**Q.2.1V a. Moving Parts** - The CTS protection of crew from moving parts that may cause injury shall be verified through analysis. An analysis shall be performed to identify potential mechanical hazards accessible to crew and their designed control measures. The verification shall be considered successful when the analysis shows that mechanical hazards are either inaccessible to crew or have acceptable control measures to prevent injury.

b. **Entrapment** - The protection of crew from entrapment shall be verified through analysis and demonstration. An analysis shall be performed to identify potential sources for entrapment and their designed control measures. Demonstration of crew motion restraints shall be performed using flight representative retention systems to verify that crewmembers are able to release fasteners under simulated nominal and emergency conditions. The verification shall be considered successful when analysis and demonstration show that potential entrapment sources are controlled (reference Sections 6.3.3.4 and 6.3.3.5 of SSP 50005) and that crew can release from motion restraints.

c. **Sharp Edges**

i. **Sharp Edges for Corners** - Corner and edge rounding for fixed and handheld equipment shall be verified by inspection. Inspections shall be made of drawings of fixed and handheld equipment to which the crew will be exposed for corner and edge rounding specifications. Inspections shall also be made on flight hardware focusing on exposed edges and corners with which the crew may come in contact. The verification shall be considered successful when the inspection confirms that corners and edges meet the exposed edge and roundness specifications in Sections 6.3.3.1, 6.3.3.2 and 6.3.3.3 of SSP 50005.

ii. **Sharp Edges for Loose Equipment** - Corner and edge rounding for loose equipment shall be verified by inspection. An inspection shall be made of drawings of loose equipment to which the crew will be exposed for corner and edge rounding specifications. The verification shall be considered successful when the inspection confirms that corners and edges meet the edge and roundness specifications in Section 6.3.3.11 of SSP 50005.

d. **Sharp Items** - Crew protection from functionally sharp items shall be verified by analysis and inspection. An analysis shall be performed to identify physical control measures for functionally sharp edges. An inspection of drawings shall be performed to verify incorporation of the designed control measures. The verification shall be considered successful when the inspection of the design shows that functionally sharp items include the control measures to prevent injury.

d. **Burrs** - Absence of burrs on surfaces shall be verified by inspection. An inspection of flight hardware focusing on exposed surfaces that the crew may contact shall be made. The verification shall



be considered successful when the inspection confirms that exposed surfaces are free of burrs (reference Section 6.3.3.9 of SSP 50005).

f. Pinch Points - Prevention crew injury from pinch points shall be verified by analysis. An analysis shall be performed to identify potential pinch points accessible to crew and their designed control measures. The verification shall be considered successful when the analysis shows that pinch points are either inaccessible to crew or have acceptable control measures to prevent injury (reference Section 6.3.3.8 of SSP 50005).

g. Stored Potential Energy - The protection of crew from stored potential energy shall be verified through analysis. An analysis shall be performed to identify stored potential energy sources and their designed control measures. The verification shall be considered successful when the analysis shows that stored potential energy sources are inaccessible to crew or have acceptable control measures to prevent injury. [V.CTS.248]

## **Q.2.2 Hot Temperature Hazards**

For materials having exposed surface temperature (TES) greater than 45°C (113°F), bare skin contact shall be controlled as follows.

a. For incidental contact, defined as contact times of 1 second or less, calculate permissible material temperature (TPM) and implement control for hazard as follows.

1. If TES is less than or equal to TPM, bare skin contact is permissible.
2. If TES is greater than TPM, bare skin contact is not permissible; implement design control for hazard.

b. For intentional contact, defined as planned skin contact for any length of time, calculate TPM for the expected contact time and implement control for hazard as follows.

1. If TES is less than or equal to TPM, bare skin contact is permissible.
2. If TES is greater than TPM, bare skin contact is not permissible; implement design control for hazard. [R.CTS.249]

*Rationale: To prevent pain and preclude skin damage, exposed IVA TES subject to contact by crew are to not cause the epidermis and dermis interface temperature from exceeding 44°C (111°F) and from dropping below 10°C (50°F), per NASA-STD-3001 Volume 2. When surfaces exposed to crew contact have extreme temperatures, either hot or cold, the hazards are to be controlled. Hazardous temperatures are established by the difference between TPM and the measured TES. The material temperature threshold 45°C (113°F) is based on research showing that skin damage occurs when temperature at the epidermis/dermis interface TE/D exceeds 44°C (111°F) (Moritz and Henriques, 1947). Analytical modeling of different contact times for two semi-infinite solids at different uniform initial temperatures found 45°C (113°F) to be the lowest damaging material temperature and therefore, an appropriate hot temperature threshold as a screening point for all commonly used materials.*

**Q.2.2V** Hot touch temperature shall be verified by test and analysis. Test shall be conducted to measure temperature of hot surfaces that are exposed to crew contact. Where  $TES > 45^{\circ}\text{C}$  ( $113^{\circ}\text{F}$ ), an analysis shall be performed to determine maximum TPM for those exposed surfaces. The verification shall be considered successful when test and/or analysis show that temperatures for exposed surfaces are lower than TPM and appropriate hazard control measures are implemented.

TPM shall be calculated as follows:

When calculating TPM for intentional contact, a minimum time of 10 seconds applies. Where contact time for nominal operations is planned to exceed 10 seconds, time increments for up to 30 seconds, up to 60 seconds, or infinite time are to be used. Because contact time is a factor in establishing permissible material temperature, consider the following if there is potential for exceeding planned contact time:

- Either calculate  $T_{PM}$  using higher or infinite contact time, especially if there may be an adverse consequence due to unplanned release of an object, or
- Inform crewmembers of the contact time limit via an operational control that has been coordinated with the operations community.

The equation for TPM assumes the object material is homogeneous. If the object is a layup of different materials (i.e., is comprised of layers), TPM is to be calculated using the thermophysical properties of the material with lowest value for inverse thermal inertia. Alternately, with justification, TPM may be calculated using the thermophysical properties of the material in the layup that is the largest contributor to the change in skin temperature. Refer to the NASA/SP-2010-3407, Human Integration Design Handbook (HIDH) for additional guidance on calculating TPM.

1. For incidental contact, defined as contact time  $t \leq 1$  second:

$$T_{PM} (^{\circ}\text{C}) = a * (k\rho c)^{-1/2} + b$$

Where:

- $(k\rho c)^{-1/2}$  = inverse thermal inertia of material ( $\text{cm}^2 \text{ }^{\circ}\text{C sec}^{1/2}$ )/cal (Table Q.2.2V-1)
- a = 0.92
- b = 69.97

2. For intentional contact, defined as planned skin contact for any length of time:

$$T_{PM} (^{\circ}\text{C}) = a * (k\rho c)^{-1/2} + b$$

Where:

- $(k\rho c)^{-1/2}$  = inverse thermal inertia of material ( $\text{cm}^2 \text{ }^{\circ}\text{C sec}^{1/2}$ )/cal (Table Q.2.2V-1)
- a, b = constants in Table Q.2.2V-2 Hot Temperature Constants for Intentional (Planned) Contact

**Table Q.2.2V-1: Inverse Thermal Inertia for Commonly Used Materials**

Material	Inverse Thermal Inertia $(k\rho c)^{-1/2}$ $((\text{cm}^2 \text{ }^{\circ}\text{C sec}^{1/2})/\text{cal})$
----------	--

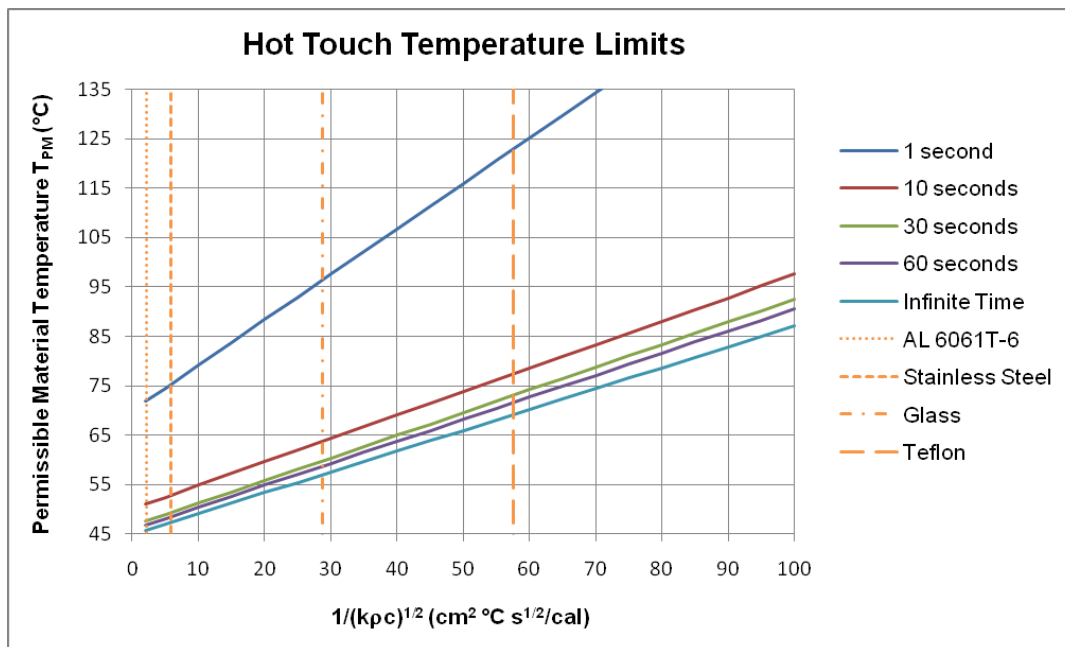
Aluminum (6061T-6)	2.2
316 Stainless Steel	5.9
Glass	28.8
Teflon	57.5
Nylon Hook Velcro	586 (effective)
k = thermal conductivity, $\rho$ = density, c = specific heat	

**Table Q.2.2V-2: Hot Temperature Constants for Intentional (Planned) Contact**

Contact Time (s)	a	b
10	0.48	50.07
30	0.46	46.61
60	0.45	45.90
$\infty$	0.42	44.87

Note: for intentional contact, a minimum time of 10 seconds applies when calculating  $T_{PM}$ .

Figure Q.2.2V-1 illustrates hot  $T_{PM}$  for incidental and intentional (planned) contact and four common materials. [V.CTS.249]



**Figure Q.2.2V-1: Hot Temperature Limits**

### Q.2.3 RESERVED

### Q.2.3V RESERVED

### Q.2.4 Cold Temperature Hazards

For materials having exposed surface temperature (TES) less than 0°C (32°F), bare skin contact shall be controlled as follows:

- a. For incidental contact, defined as contact times of 1 second or less, calculate permissible material temperature (TPM) and implement control for hazard as follows.
  1. If TES is greater than or equal to TPM, bare skin contact is permissible.
  2. If TES is less than TPM, bare skin contact is not permissible; implement design control for hazard.
- b. For intentional contact, defined as planned skin contact for any length of time, calculate TPM for the expected contact time and implement control for hazard as follows.
  1. If TES is greater than or equal to TPM, bare skin contact is permissible.
  2. If TES is less than TPM, bare skin contact is not permissible; implement design control for hazard. [R.CTS.251]

*Rationale: To prevent pain and preclude skin damage, exposed IVA TES subject to contact by crew are to not cause the epidermis and dermis interface temperature from exceeding 44°C (111°F) and from dropping below 10°C (50°F), per NASA-STD-3001 Volume 2. When surfaces exposed to crew contact have extreme temperatures, either hot or cold, the hazards are to be controlled. Hazardous temperatures are established by the difference between TPM and the measured TES. Research on human tolerance to cold has shown that when skin temperature is at 7°C (44.6°F) numbness occurs (Provins and Morton12) and at 0°C (32°F) frostbite is risked (Havenith et al. 10). While contact with objects at 0°C (32°F) may elicit pain, the object will not cause skin temperature to drop below 0°C, which is the temperature at which frostbite damage can occur.*

**Q.2.4V** Cold touch temperature shall be verified by test and analysis. Test shall be conducted to measure temperature of cold surfaces that are exposed to crew contact. Where  $TES \leq 0^{\circ}C$  (32°F), analysis shall be performed to determine the minimum TPM for those exposed surfaces. The verification shall be considered successful when test and/or analysis show that temperatures for exposed surfaces are higher than TPM and appropriate hazard control measures are implemented.

TPM shall be calculated as follows:

When calculating  $T_{PM}$  for intentional contact, a minimum time of 10 seconds applies. Where contact time for nominal operations is planned to exceed 10 seconds, time increments for up to 30 seconds, up to 60 seconds, or infinite time are to be used. Because contact time is a factor in establishing permissible material temperature, consider the following if there is potential for exceeding planned contact time:

- Either calculate  $T_{PM}$  using higher or infinite contact time, especially if there may be an adverse consequence due to unplanned release of an object, or
- Inform crewmembers of the contact time limit via an operational control that has been coordinated with the Operations community.

The equation for  $T_{PM}$  assumes the object material is homogeneous. If the object is a layup of different materials (i.e., is comprised of layers),  $T_{PM}$  is to be calculated using the thermophysical properties of the material with lowest value for inverse thermal inertia. Alternately, with justification,  $T_{PM}$  may be calculated using the thermophysical properties of the material in the layup that is the largest contributor to the change in skin temperature. Refer to the NASA/SP-2010-3407, Human Integration Design Handbook (HIDH) for additional guidance on calculating  $T_{PM}$ .

1. For incidental contact, defined as contact time  $t \leq 1$  second:

$$T_{PM} (\text{°C}) = a * (k\rho c)^{-1/2} + b$$

Where:

- $(k\rho c)^{-1/2}$  = inverse thermal inertia of material ( $\text{cm}^2 \text{°C sec}^{1/2}$ )/cal (Table Q.2.2V-1)  
 a, b = constants in Table Q.2.4V-1 Cold Temperature Constants for Incidental Contact

2. For intentional contact, defined as planned skin contact for any length of time:

$$T_{PM} (\text{°C}) = a * (k\rho c)^{-1/2} + b$$

Where:

- $(k\rho c)^{-1/2}$  = inverse thermal inertia of material ( $\text{cm}^2 \text{°C sec}^{1/2}$ )/cal (Table Q.2.2V-1)  
 a, b = constants in Table Q.2.4V-2 Cold Temperature Constants for Intentional (Planned) Contact

**Table Q.2.4V-1: Cold Temperature Constants for Incidental Contact**

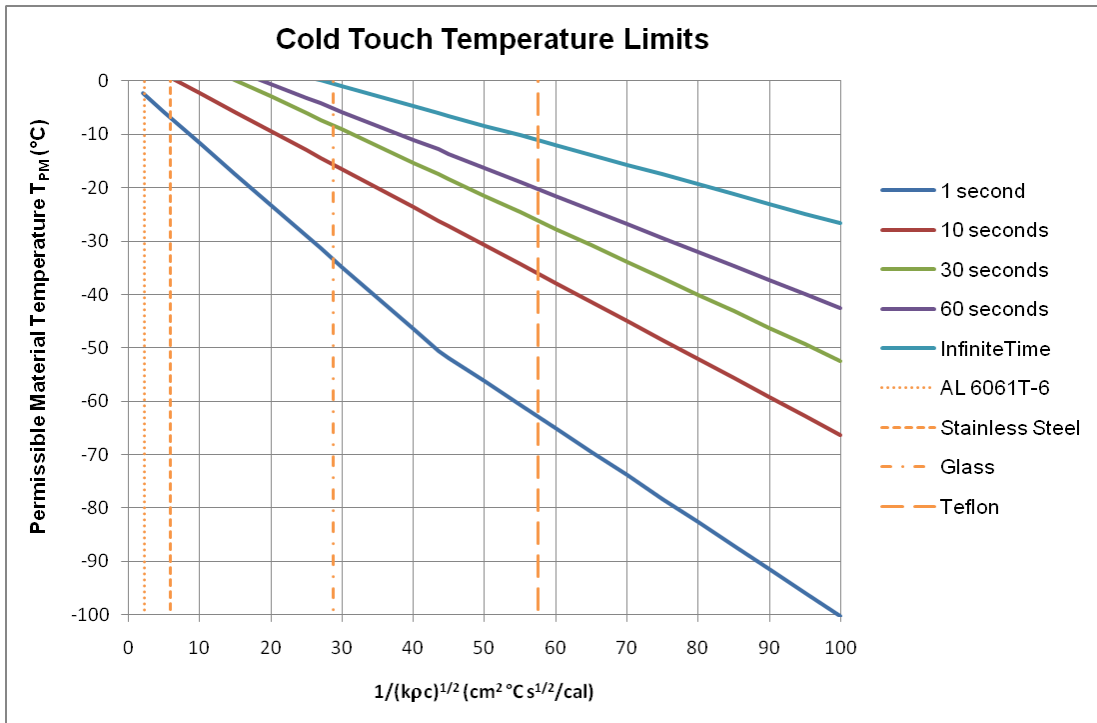
time (s)	$(k\rho c)^{-1/2}$	a	b
1	$\leq 43.5$	-1.16	0
	$> 43.5$	-0.88	-12.29

**Table Q.2.4V-2: Cold Temperature Constants for Intentional (Planned) Contact**

time (s)	a	b
10	-0.71	4.78
30	-0.62	9.51
60	-0.53	10.00
$\infty$	-0.37	10.00

Note: for intentional contact, a minimum time of 10 seconds applies when calculating  $T_{PM}$

Figure Q.2.4V-1 illustrates cold  $T_{PM}$  for incidental and intentional (planned) contact and four common materials. [V.CTS.251]



**Figure Q.2.4V-1: Cold Temperature Touch Limits**

### Q.2.5 Crew Control of Power

The CTS shall provide crewmembers with capability to control the interruption of power to an electrical circuit and confirm the de-energized status of the circuit that requires crew access for maintenance or mate/demate of energized elements. [R.CTS.252]

*Rationale: The intent of this requirement is to provide the crew with the capability to interrupt power, as opposed to only remote ground control, so that a crewmember performing a maintenance action will have the ability to interrupt power to the area and confirm the de-energized status of the electrical circuitry before initiating work in that area. This is not only to protect the crew from potential electrical shock, but to protect against molten metal or other critical equipment damage from arcing or intermittent electrical contact. For equipment (i.e., low voltage audio, video, data systems, etc.) that is less than 180 watts and that mate/demate operations have been analyzed to pose no crew or equipment hazards, this requirement is not applicable.*

**Q.2.5V** Crew interruption of electrical power and confirmation of energized circuits shall be verified by analysis, inspection, and test. An analysis shall be performed to identify circuits that require crew

access for maintenance or mate/demate of energized elements. A test shall be performed on flight representative hardware and software to verify power can be removed for connectors planned to be mated and demated in flight. This requirement is not applicable for equipment (i.e., low voltage audio, video, data systems, etc.) that is less than 180 watts and that mate/demate operations have been analyzed to pose no crew or equipment hazards. The verification shall be considered successful when the analysis and inspection of drawings show that the system provides crew with the capability to energize/de-energize and confirm status of such circuits and when the test shows measured voltage indicates 0.0 volts for circuits involved in this verification. [V.CTS.252]

## **Q.2.6 Electrical Hazard Potential**

The CTS shall protect crewmembers from unintentional electrical current exposure and minimize electrical shock hazards by designing equipment to have the following:

- a. All conductive surfaces shall be bonded to the vehicle's electrically referenced ground.
- b. Circuit isolation shall be implemented such that:
  1. All equipment not permanently bonded to electrical ground reference has a chassis leakage current not to exceed 0.1mA (ac plus dc components) when referenced through an equivalent crew impedance; and
  2. The power inputs for all equipment are dc isolated from chassis/structure by a minimum of 1 mega ohm.
- c. A third independent hazard control shall be implemented for equipment not permanently bonded to electrical ground reference (e.g., portable equipment) when voltages produced or utilized by the equipment exceed 42.2 V peak (ac plus dc component). [R.CTS.253]

*Rationale: The intent of this requirement is to prevent electrical shock hazards through the design of appropriate levels of hazard control. This requirement applies to all non-patient equipment receiving, providing, or storing electric power, that are intended for crew operation (e.g., portable computers and other powered portable devices, electronic control panels, etc.). This requirement does not address equipment that captures or attaches to the human or breaks the skin or blood barrier, such as space suits or medical devices. Portable equipment is defined as any equipment not permanently bonded to the vehicle's electrical ground via surface mount or permanent ground strap. Note that insulated portable equipment may have conductive connectors that must be grounded. Any normal chassis (enclosure) leakage value will be below threshold of shock to qualify as a complete hazard control. All values are defined in IEC 60601-1, 3rd edition with the Leakage per 8.7.3-c with compliance to 8.7.4 and Voltage limits per 8.4.2-c. The values provided in paragraphs B and C are for hand-to-hand, both hands-to-feet, and hand-to-seat contact applications as defined in IEC/TR 60479-5 Effects of current on human beings and livestock - Part 5: Touch voltage threshold values for physiological effects. A third independent hazard control is typically a second ground wire or double-insulated circuitry. For non-patient equipment, a crew electrical shock hazard protection system utilizing Design for Minimum Risk (DFMR) criteria may be used in lieu of the fault tolerance approach.*

## Q.2.6V

- a. Verification of electrical bonding requirements shall be accomplished by a combination of test, analysis, and inspection. The verification shall be considered successful when the test, analysis and inspection show the design is compliant with documentation that meet the intent of NASA-STD-4003.
- b. Verification of circuit isolation requirements shall be accomplished by test.
  1. For all equipment not permanently bonded to electrical ground reference, a test shall be conducted to measure the chassis leakage current. The verification shall be considered successful when the chassis leakage current is shown to be less than 0.1 milliamps peak during steady state operations. The current is measured between the electrical ground reference, through a crew equivalent impedance, and to any point on the equipment enclosure accessible to the crew during normal operation (metal parts, knobs, grips, connectors, etc.). The typical test setup for leakage current measurements that include the "equivalent crew impedance" is shown in Figure Q.2.6V-1.
  2. For all equipment, a test shall be conducted to measure the dc isolation from chassis/structure. The verification shall be considered successful when each power input (hot and return) is dc isolated from chassis/structure by at least 1 megohm.
- c. Verification of a third hazard control for equipment not permanently bonded to electrical ground reference, where the possible current pathways are hand-to-hand, both hands-to-feet, or hand-to-seat, shall be accomplished by analysis or test, and inspection. An analysis or test shall be performed to identify if voltages produced or utilized by the equipment exceed 42.4 V peak (ac plus dc component). For equipment exceeding 42.4 V peak, verification shall be considered successful when inspection of drawings or equipment confirm implementation of a third independent hazard control (typically a second ground wire or double-insulated circuitry). [V.CTS.253]



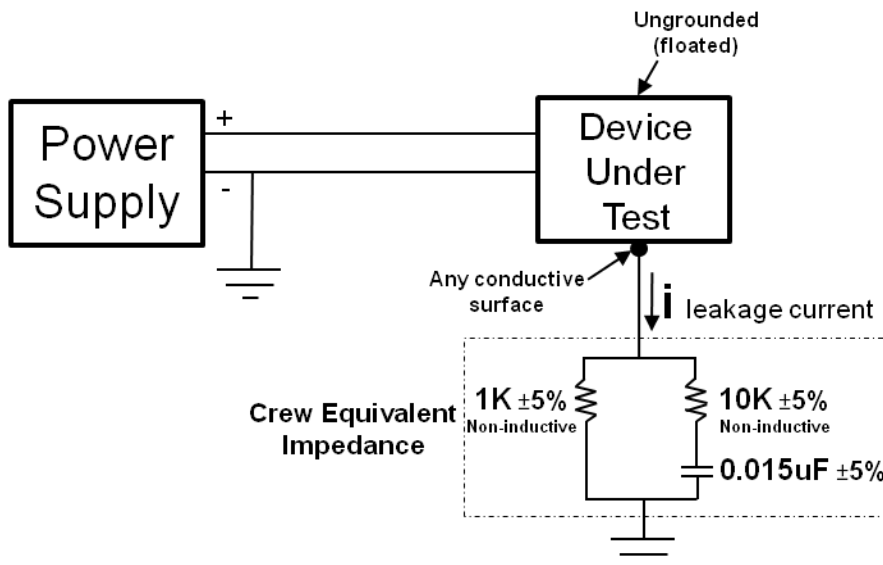


Figure Q.2.6V-1 Typical Test Setup for Leakage Current Measurements

**Q.2.7 RESERVED**

**Q.2.7V RESERVED**

### **Q.3: Crew Control Interfaces**

#### **Q.3.1 Use of Color**

When color is used to convey meaning on a display for critical information and critical tasks, the spacecraft shall provide an additional cue. [R.CTS.140]

*Rationale: Redundant coding is required to accommodate the variability in people's capability to see color under different lighting conditions and to increase the saliency of identification markings. Redundant cues can include labels, icons, and speech messages.*

**Q.3.1V** The spacecraft's redundancy of color interface cues shall be verified by demonstration. The demonstration shall be performed using flight representative software, crew interfaces and a list of representative data types. The demonstration shall determine whether the color-coded interface components also provide a second cue to convey that meaning. The verification shall be considered successful when the demonstration shows that all color-coded interface components provide a second non-color cue when color is used to convey meaning. [V.CTS.140]

#### **Q.3.2 Data Availability**

The spacecraft shall inform the crew when a displayed data parameter is missing or unavailable. [R.CTS.141]

*Rationale: Feedback on data that are unavailable (i.e., lost or stale) is critical to the crew for accurately weighing data during troubleshooting and decision-making periods.*

**Q.3.2V** The spacecraft loss of displayed data parameters shall be verified by demonstration. The demonstration shall be performed using flight representative software and crew interfaces and a list of representative data types. The demonstration shall run a scenario that results in the loss of data parameters for the data sets being tested. The verification shall be considered successful when the demonstration shows that the vehicle provides an indication to the crew that the parameters for each tested data set are unavailable. [V.CTS.141]

#### **Q.3.3 Display Area for Task Support**

The spacecraft shall provide the display area necessary to present information required for a critical task simultaneously to a single operator who is performing the critical task. [R.CTS.145]

*Rationale: Rapid response to mission-critical tasks will require simultaneous display of multiple sources of information to a single crewmember. Without sufficient display area, crewmembers may be faced with cumbersome and time-consuming display navigation operations that will increase information access time and potential for errors. Critical task information needs to be viewed simultaneously. This requirement might be met with a large display device or multiple smaller ones, but regardless, the information must be readable and usable. This requirement should not be used to justify a highly dense, cluttered display design; rather, it requires careful analysis of the specific information required of a critical task. Please refer to the usability requirement verification for more details on defining a task.*

**Q.3.3V** The spacecraft's capability of supporting simultaneous viewing of critical task information shall be verified by analysis. The analysis shall determine for each critical task: 1) the limited set of information required for that critical task, and 2) whether or not the identified information can be simultaneously displayed, in a readable, usable form within the field of regard of a suited and seated crewmember performing the task. The verification shall be considered successful when the analysis shows that the vehicle can simultaneously display the information needed for each critical task. [V.CTS.145]

### **Q.3.4 Design of Controls**

Spacecraft controls that are intended for out-of-view operation shall be spatially or tactually distinct from one another. [R.CTS.146]

*Rationale: When the crew inadvertently operates the wrong control, serious errors can result. Controls designed to be out-of-view while being operated must be spaced or shaped/textured such that the control can be identified without line of sight. This would include controls for vehicle operation as well as other controls (e.g., seat positioning). It has been shown that human operators can use simple tactile coding to reliably distinguish between items. Inadvertent operation prevention must be provided in accordance with NPR 8705.2B, Section 3.2.4.*

**Q.3.4V** The crew ability to operate out-of view controls shall be verified by analysis and test. A task analysis shall be performed to identify human activities required for nominal and off-nominal operation in the applicable mission phases and environments. The task analysis shall identify controls intended for out-of-view usage. Tasks where out of view controls are used shall be tested for error rates. The verification shall be considered successful when the error testing shows that out of view controls are acceptable per 3.10.4.4, Design Induced Crew Errors. [V.CTS.146]

### **Q.3.5 Control Labeling**

The CTS shall provide labeling for crew interfaces. [R.CTS.147]

*Rationale: Crew interface items include vehicle location and orientation, hardware and equipment, cables and connectors, controls and displays, stowage compartments, etc.; anything with which crew may interact. Crew interface items are to have identifying labels to aid in crew in performing nominal and emergency operations, identifying location or orientation, or identifying hazards, etc. Clearly identifying items with function based readable labeling using text size appropriate for the item and its operational use and located directly adjacent to items being labeled reduces cognitive load and improves task efficiency by allowing crewmembers to quickly locate and recognize needed operational interfaces. Guidance on implementation of labeling for crew interfaces can be found in Section 4.13 of JSC 65995, CHSIP.*

*Finally, a common operational language is needed to ensure clear communication and understanding of information the crew must process, manage, or take action on. English is the common operational language for the ISS, as specified in SSP-50200, SPIP Volume 9. Furthermore, consistent use of terminology and naming, including operational nomenclature and acronyms, is needed to ensure clear communication. The ISS program has a well-established OpNom and acronym library and process for assigning OpNom, which is described in SSP 50254 – Operations Nomenclature.*

**Q.3.5V** The CTS labeling of crew interfaces shall be verified through inspection. The inspection shall consist of inspection of the vehicle Label Plan, drawings, and other relevant vehicle design and operational documentation. The verification shall be considered successful when the inspection shows that crew interfaces are identified with labeling. [V.CTS.147]

### **Q.3.6 Control Coding**

The spacecraft shall provide coding for emergency controls that are distinguishable from non-emergency controls. [R.CTS.148]

*Rationale: Coding for emergency controls should allow the operator to distinguish them from other controls. This will help the operator react faster in an emergency situation. It has been shown that operators react more quickly to simple coding such as colors and pictures than they do to written labels. A task analysis defines the list of emergency controls. Guidance on the development of hazard, caution and warning, and emergency use labels and coding can be found in Section 4.13 of JSC 65995.*

**Q.3.6V** The spacecraft's coding for emergency controls shall be verified by analysis and inspection. A task analysis shall be performed to identify human activities required for nominal and off-nominal operation in the applicable mission phases and environments. The inspection of emergency controls shall include a review of the vehicle Label Plan and determine whether coding is compliant. The verification shall be considered successful when the inspection shows that coding meets the emergency coding defined in SSP 50005, Section 9.5.3.2.I.(4), IVA Coding Design Requirements, Familiar Color. [V.CTS.148]

### **Q.3.7 High-g Control Configuration**

The spacecraft shall configure controls used during accelerations above 3 g so that the crew can make control inputs via hand/wrist movements of a supported limb without reaching. [R.CTS.150]

*Rationale: Above 3 g, controls must be operable by a restrained crewmember. In a study of reaches under Gx loading with veteran astronauts and aviators as suited subjects, there was a 6% reduction in forward reach displacement at 3 g, 18% at 4 g, and 32% at 5 g (Schafer & Bagian, Aviation, Space, and Environmental Medicine, 64: 979, 1993). Above 3 g, the accuracy of gross limb movements is compromised, and thus control action under these conditions should be limited to hand and wrist motions alone.*

*Arms/legs will require proper support and/or restraint to allow for accurate control inputs during elevated g conditions and to prevent inadvertent control inputs during high-g nominal and abort scenarios. Proper arm/wrist support should be provided such that operation of any hand controller is not hampered by g-loading.*

**Q.3.7V** The spacecraft's control placement for operations at 3 g or more shall be verified by analysis. A task analysis shall be performed to identify human activities required for nominal and off-nominal operation in the applicable mission phases and environments. The analysis shall be performed using a list of controls used during operations at 3 g or more as determined by the task analysis. The analysis shall determine whether the controls can be accessed by a hand/wrist movement of a

restrained/supported arm taking into account the full anthropometric range of crewmembers. The verification shall be considered successful when the analysis shows that controls used in operations at 3 g or more are accessible by hand/wrist movements of a restrained/supported arm. [V.CTS.150]

### **Q.3.8 Moderate-g Control Configuration**

The spacecraft shall configure controls used during accelerations between 2g and 3g so that the crew can make control inputs via hand/wrist movements of a supported limb and reaches within a forward +/-30 degree cone. [R.CTS.151]

*Rationale: Between 2 g and 3 g, controls must be operable by a restrained crewmember. In a study of reaches under Gx loading with veteran astronauts and aviators as subjects, suited subjects on average exhibited little impact at 2 g but did show a 6% reduction in maximum forward reach displacement at 3 g (Schafer & Bagian, Aviation, Space, and Environmental Medicine, 64: 979, 1993). Hence, between 2 g and 3g, even with highly motivated and trained subjects, reaches will begin to show errors above 2 g, and so control actions should be limited to hand/wrist motions or forward arm movements within a +/- 30 degree cone (apex at the shoulder joint, aligned with the axis of acceleration). For tasks requiring rapid response times or for deconditioned crew, a more conservative approach with controls placed to minimize reach - allows for an improved crew ability to operate the control. Awkward shoulder/elbow postures, which could result from reaches to displays/interfaces at close distances, increase fatigue and errors resulting in high crew workloads that could exceed workload requirements. Additionally, proper arm/wrist support should be provided such that operation of any hand controller is not hampered by g-loading.*

**Q.3.8V** Control placement for operations between 2 g and 3 g shall be verified by analysis. A task analysis shall be performed to identify human activities required for nominal and off-nominal operation in the applicable mission phases and environments. The analysis shall be performed using a list of controls used during operations between 2 g and 3 g as determined by a task analysis. The analysis shall determine whether the controls can be accessed either by hand/wrist movements of a restrained/supported arm or by forward reaches taking into account the full anthropometric range of crewmembers. The verification shall be considered successful when the analysis shows that controls used during operations between 2 g and 3 g are accessible by hand/wrist movements of a restrained/supported arm or by a reach within a forward +/- 30 degree cone. [V.CTS.151]

### **Q.3.9 Control Activation Indication**

The spacecraft shall provide a positive indication of crew-initiated control activation for critical functions. [R.CTS.144]

*Rationale: A positive indication of control activation is used to acknowledge the system receipt of the control action. For example, a physical detent, an audible click, an integral light, or a switch position may be used to provide a positive indication of control activation.*

**Q.3.9V** The spacecraft's feedback of crew-initiated control activation shall be verified by demonstration. The demonstration shall consist of simulating crew activation of flight representative hardware and software controls. The verification shall be considered successful when the demonstration

shows that all control systems provide an indication of crew-initiated control activations for critical functions. [V.CTS.144]

### **Q.3.10 Interface Legibility**

The spacecraft shall provide crew interfaces that are legible under nominal conditions.  
[R.CTS.368]

*Rationale: Legibility is important for the crew's timely and accurate processing of information. Legibility may vary depending on vehicle conditions (for example, acceleration, vibration, and lighting) and must be accommodated. For example, during flight phases where high vibration is expected, relevant displays may need to be designed with this in mind (for example, analog versus digital displays, larger graphics and text.*

**Q.3.10V** The legibility of crew interfaces shall be verified by analysis and test. A task analysis shall be performed to identify human activities required for nominal operation in the applicable mission phases and environments. The tasks shall be reviewed to determine relevant legibility data to identify the interfaces that need to be read and interpreted, and the correlating vehicle conditions and environments. The test shall consist of a legibility test conducted with a minimum of five participants in a flight representative vehicle in the flight configuration. The legibility test shall consist of rapid serial visual presentation and subsequent verbal identification by subjects of a representative selection of targets such as hardware labels and software elements (alphanumeric, icons, and symbols). The verification shall be considered successful when the test shows an average identification accuracy of 98% for each type of target. [V.CTS.368]

### **Q.3.11 Control Glare**

The spacecraft shall control glare on windows and displays in support of crew tasks.  
[R.CTS.369]

*Rationale: The wide range of operating orientations of the spacecraft will create many instances in which the sun will shine directly on the console or windows creating substantial glare and impede crew operations. The provider must plan for these orientations and enable safe operations by blocking stray light with covers, shutters or other means to eliminate glare.*

**Q.3.11V** The spacecraft's control of glare on windows and displays shall be verified by demonstration. The demonstration shall utilize a flight representative vehicle in the flight configuration with representative sunlight on the vehicle and glare control in place. The verification shall be considered successful when the demonstration shows that the displays are legible and windows for viewing tasks are free of glare. [V.CTS.369]

## **Q.4: Crew Task Support**

### **Q.4.1 Captive Fasteners**

All fasteners used by the crew shall be captive. [R.CTS.137]

*Rationale: Fasteners can be lost either by loosening during normal use or by becoming misplaced during maintenance operations. This is particularly important in zero gravity environments, because small items, such as fasteners, can be very difficult to find, replacements parts are not available, and lost parts can cause jams in mechanisms or problems in other spacecraft systems. Additionally, to enhance operational efficiency, the number and variety of fasteners to be removed by the crew should be minimized.*

**Q.4.1V** Use of captive fasteners shall be verified by inspection. Drawings of hardware and equipment requiring crew maintenance and using fasteners will be inspected. The verification shall be considered successful when the inspection confirms that fasteners are retained when unfastened. [V.CTS.137]

### **Q.4.2 Stowage Locations**

The spacecraft shall provide defined stowage locations and restraints for both stowed and deployed items to prevent interference with crew operations or injury to the crew. [R.CTS.212]

*Rationale: Portable items are those items not permanently attached to the vehicle such as food, personal items, medical kits, trash, etc. To maintain a habitable volume and high level of efficiency and safety in crew operations, it is important to use a human centered design approach so that stowage locations are: 1) easily accessible (e.g., items located at their point of use or consumption, frequently used items can be accessed without having to remove other items, items can be removed and replaced, etc.) and 2) functionally arranged (e.g., all items required in a single task or procedure located together, grouped items accessible in priority order).*

*Guidance on the human centered design approach can be found in Section 3.1 of JSC 65995. Information on using task analysis process in design can be found in Section 4.1.*

*Securing items from unintended movement ensures crew and equipment safety and prevent items from moving out of their stowed locations under expected conditions for acceleration, vibration, or crew contact. In microgravity, retaining stowage restraints facilitates removal and replacement of stowed items when restraints are opened/loosened. For example, attached covers should be retainable in open position to allow crewmembers to access stowed items without requiring the crewmember to hold the cover.*

*Hardware, equipment, and loose items generated during operations that are deployed in the habitable volume should be restrained to protect crew from collision injury, protect equipment from damage, or prevent loss. Appropriate restraints and/or handholds are to be considered for items that are grasped or gripped to be moved by crewmembers.*

**Q.4.2V** The spacecraft's defined stowage locations and restraints for portable items shall be verified through analysis and demonstration. An analysis shall be performed to evaluate the effect of expected acceleration, vibration, and crew forces on the restraints of stowed items. The demonstration shall be performed using flight-representative stowage with restraints. The demonstration will show that an operator can stow and restrain, and un-stow and un-restrain, representative items and that restraints can

be retained to facilitate stowage operations. The verification shall be considered successful when the analysis and demonstration show that defined stowage locations and restraints are provided for stowed and deployed items that prevent interference with crew operations and protect the crew from injury, equipment from damage, and prevent loss. [V.CTS.212]

### **Q.4.3 Location Coding**

The CTS shall use a location coding system to provide a unique identifier for each defined location within the spacecraft. [R.CTS.214]

*Rationale: Location coding provides a clear and consistent method for referring to or finding different locations within the vehicle. Locations identifiers facilitate spatial awareness and communication when traversing the vehicle or locating equipment or workstations. The ISS has an established method for location coding, which can be found in SSP 30575, Space Station Interior and Exterior Operational Location Coding System. This method may be used as guidance for developing vehicle location coding.*

**Q.4.3V** The CTS's coding of locations within the spacecraft shall be verified by inspection. Drawings and CAD models of defined locations within the spacecraft shall be inspected. The verification shall be considered successful when inspection confirms that unique identifiers are provided for defined locations within the spacecraft. [V.CTS.214]

### **Q.4.4 Crew Restraints and Mobility Aids**

The spacecraft shall provide crew restraints and mobility aids for all functions required by the crew. [R.CTS.215]

*Rationale: Crew restraints provide for operator stability. Mobility aids allow crewmembers to efficiently and safely move from one location to another in microgravity. Where it is critical that a crewmember remain stable for task performance (such as viewing through an eyepiece, operation of a keyboard), foot restraints and other ad hoc positioning techniques are insufficient for tasks performed continuously for long periods of time. Restraining system design is to take into account proper duration and be stable and intuitive, requiring little to no training to operate. Body posture and required motions for the task must be considered. For example, two-handed tasks require proper foot restraints and not hand holds to maintain a static posture. Proper crew restraints are critical while operating controls in docking or vehicle control scenarios.*

*A crewmember should be able to operate controls in reduced gravity, as well as during dynamic or multi-axis accelerations. Maintaining a position and orientation during controls operation is necessary to ensure that controls can be activated without motion being imparted to the crewmember. There is extensive crew feedback on existing restraints and their use that can aid the design process. Early experience in the Skylab program showed the problems of movement in microgravity. Stopping, starting, and changing direction all require forces that are best generated by the hands or feet. Appropriately located mobility aids make this possible. Mobility aids are to be designed to accommodate a pressurized suited crewmember by providing clearance, non-slip surfaces, and noncircular cross sections. Without predefined mobility aids, personnel may use available equipment that could be damaged from induced loads. Mobility*



*aids should be standardized. By standardization of the mobility aids, reduction in crew training can occur, and the aids can be easily identified when translating within a spacecraft volume.*

**Q.4.4V** The spacecraft's crew restraint and mobility aid placement and design shall be verified by analysis and inspection. A task analysis shall be performed to identify tasks requiring operator stability and translation activities in the applicable mission phases and environments. The inspection shall consist of a review of engineering drawings, 3D CAD models, and identified locations of mission tasks and translation paths. The verification shall be considered successful when the inspection shows that restraint and mobility aid placement and design accommodate motions and body posture of the crew in their flight configuration required for the task. [V.CTS.215]

## **Q.5: Hatch and Window Design**

### **Q.5.1 Crew Hatch Opening**

The primary crew ingress/egress hatch shall fully open in less than 30 seconds of the crew initiating the opening. [R.CTS.168]

*Rationale: The primary crew ingress/egress hatches should move to the full-open position in a timely manner to minimize hindrances to crew egress in emergency scenarios. The full-open time requirement is applicable under worst-case, no-damage pressures.*

**Q.5.1V** The full opening of the primary crew ingress/egress hatch by flight crew inside the vehicle within 30 seconds of initiation shall be verified by demonstration. The demonstrations shall be with a flight representative hatch and crew in the flight configuration. The verification shall be considered successful when the demonstration achieves full opening of the hatch within 30 seconds. [V.CTS.168]

### **Q.5.2 External Hatch Opening**

The primary ingress/egress hatch shall have an externally operated emergency mode that will allow the hatch to be opened in no more than 60 seconds after rescue personnel arrive at the spacecraft outer mold line. [R.CTS.169]

*Rationale: The primary ingress/egress hatch must be able to be quickly opened by rescue personnel in order to assist the crew with spacecraft egress in emergency scenarios. For example, a ground assisted egress mode is required in the event that the flight crew becomes incapacitated and is unable to egress the spacecraft. This mode will be initiated by rescue personnel upon their arrival at the area that allows the external hatch access into the spacecraft.*

**Q.5.2V** The full opening of the primary ingress/egress hatch by rescue personnel outside the vehicle in no more than 60 seconds shall be verified by demonstration. The demonstration shall be with the rescue personnel and spacecraft in their nominal pre-launch and post-landing configuration. The verification shall be considered successful when the demonstration achieves full opening of the primary hatch in no more than 60 seconds after rescue personnel arrive at the spacecraft outer mold line. [V.CTS.169]

### **Q.5.3 Hatch Operability without Tools**

Hatches shall be operable by a single crewmember inside the spacecraft without the use of tools during all phases when the hatch is used. [R.CTS.171]

*Rationale: Hatch operation includes unlatching/opening or latching/closing the hatch. Lost or damaged tools prevent the hatches from being opened or closed, which may result in loss of crew or loss of mission.*

**Q.5.3V** Hatch operability by a single crewmember without the use of tools shall be verified by demonstration. The demonstration shall occur in a flight representative vehicle. The demonstration shall consist of a subject performing the following tasks while in the flight configuration: unlatching and fully opening each hatch from the inside and closing and latching each fully-opened hatch from the inside. The verification shall be considered successful when the demonstration shows that the hatch is operable by a single crewmember without the use of tools. [V.CTS.171]

#### **Q.5.4 Hatch Operations**

Hatches shall require two distinct and sequential operations to unlatch. [R.CTS.172]

*Rationale: Inadvertent hatch opening and subsequent cabin depressurization would be catastrophic. Requiring two separate, distinct operations helps to ensure that the hatch will not be unlatched through accidental contact. The forces required to operate hatches must also be within the strength range of the weakest anticipated crewmember for the worst-case pressure differential anticipated. Prevention of inadvertent operations is required per NPR 8705.2B, Section 3.2.4.*

**Q.5.4V** Two distinct and sequential hatch unlatching operations shall be verified by demonstration. A demonstration shall be performed in a flight-representative vehicle with the hatch and crew in the flight configuration. The verification shall be considered successful when the demonstration shows that unlatching requires two distinct and sequential operations. [V.CTS.172]

#### **Q.5.5 Manual Pressure Equalization**

The hatch shall contain a manual pressure equalization system operable by a single crewmember on both sides of hatch. [R.CTS.173]

*Rationale: Air pressure is to be equalized on either side of a hatch to safely open the hatch. Manual pressure equalization capabilities must exist on each side of the hatch and be operable by a single crewmember during all required flight phases. In some vehicle failure scenarios, non-manual methods for pressure equalization may fail (loss of power, etc.). Manual pressure equalization enables hatch opening regardless of vehicle status.*

**Q.5.5V** Operation of the manual pressure equalization on each side of the hatch by a single crewmember shall be verified by analysis and demonstration. An analysis shall determine the maximum over and underpressure possible in nominal and contingency scenarios. A demonstration shall be performed on a flight-representative hatch with the hatch and designated crew in the flight configuration. The demonstration shall consist of performing a manual pressure equalization procedure on both sides of each hatch at the maximum expected internal/external pressure differentials. The verification shall be considered successful when the demonstration shows that the hatch can be opened after manual pressure equalization by a single crewmember. [V.CTS.173]

#### **Q.5.6 Hatch Latch Indicator**

The pressure hatches shall indicate closure and latch position status on both sides of the hatch. [R.CTS.175]

*Rationale: Indication of hatch closure and latch position status on both sides of the hatch allows both ground personnel (launch pad) and crewmembers to verify that each hatch is closed and latched. The combination of hatch closure and latch position status indicates proper security of the hatch. Hatch closure implies that the hatch is in proper position to be latched.*

**Q.5.6V** Hatch cover closure and latch position status shall be verified by demonstration. The demonstration shall occur with a flight-representative vehicle. The demonstration shall consist of the

following tasks: 1) opening the hatch and identifying that the hatch closure status indicates that the hatch is open 2) closing the hatch and identifying that the hatch closure status indicates that the hatch is closed 3) latching and identifying the latch status indicates the latch is closed; 4) opening the latch and identifying that the latch position status indicates that the latch is open. The verification shall be considered successful when the demonstration shows that the hatch closure and latch position status is displayed from each side of each hatch. [V.CTS.175]

### **Q.5.7 Hatch Pressure Gauge**

The pressure difference across the hatch shall be indicated on both sides of the hatch.  
[R.CTS.176]

*Rationale: Direct pressure difference measurement on both sides of the hatch allows both ground personnel and crewmembers to see the changes in pressure across the hatch and to know when the pressure difference is low enough to safely open the hatch.*

**Q.5.7V** Pressure difference measurement across the hatch shall be verified by test. The test shall occur on a flight-representative hatch. The test shall consist of ground and designated crew in their flight configuration reading the pressure difference measurement on both sides of each hatch throughout the range of expected internal/external pressure levels. The verification shall be considered successful when the test shows that the pressure differences are indicated on each side of the hatch. [V.CTS.176]

### **Q.5.8 Window Optical Properties**

The spacecraft shall provide optically uniform windows with optical performance properties consistent with tasking that meet the intent of JSC 66320, Optical Property Requirements for Glasses, Ceramics, and Plastics in Spacecraft Window Systems. [R.CTS.179]

*Rationale: The windows must be of sufficient optical performance so that they do not degrade visual acuity and performance. JSC 66320 provides optical properties for different types of windows according to their associated tasks. NASA STD-3001, NASA Space Flight Human System Standard, Volume 2: Human Factors, Habitability, and Environmental Health - Architecture - Windows and NASA/SP-2010-3407, NASA Human Integration Design Handbook (HIDH) - Architecture - Window, and HIDH Appendices C, D, and E provide additional reference material, design guidance, and lessons learned.*

**Q.5.8V** System window optical performance characteristics and tasking consistency shall be verified by analysis, inspection, and test. The analysis shall include a task analysis to identify the windows of the spacecraft and the nominal and off-nominal tasks to be performed at each window. The inspection shall assess the optical properties of the windows and consist of an inspection of the engineering drawings and data packs for each pane and the finished window stack. The test shall consist of optical tests. Visual uniformity inspections shall be done on the finished windows; otherwise, any other inspections may be done on witness samples. The verification shall be considered successful when the inspection and the optical tests show that the optical properties of each pane and the finished window stack meet or exceed the properties specified in JSC 66320, Optical Property Requirements for Glasses, Ceramics, and Plastics in Spacecraft Window Systems, consistent with tasking identified in the analysis and the visual uniformity inspections show that there are no readily identifiable non-uniformities in any of the individual panes and in the finished window stack. [V.CTS.179]

## **Q.5.9 Window Frame Reflectance**

Window assembly frames and supporting internal and external structure within 0.15 m (~6 in) of the entire window perimeter shall have a flat black, low reflective surface finish that reduces diffuse and specular reflectance to less than 10% and 1%, respectively over a wavelength range of 380 to 1000 nm. [R.CTS.180]

*Rationale: Stray light, spurious specular reflections, and background reflections in the window are reduced when lusterless finishes are used on the window structure itself, on the structure around the window, and on interior surfaces opposite the window. This permits viewing through the window without interference from these unwanted light sources. A number of commercially available black coatings meet these requirements, such as Z-306 paint which has a history of use within other NASA programs. This paint has a diffuse reflectance of around 5% across the visible and infrared and a specular reflectance of less than 1%. The wavelength range is specified into the near infrared because some black finishes are highly reflective in the infrared. For detailed design considerations with respect to surface finishes, consult Section 8.6.4 in NASA/SP-2010-3407, Human Integration Design Handbook (HIDH), which also provides extensive guidance for window design considerations. The human-centered design process is to be used when designing windows to support crew tasks.*

**Q.5.9V** The presence of a flat black, lusterless finish or coating on all system window frames and supporting/surrounding structure within 0.15 m (~6 in) of the perimeter of any window in all directions, both internally and externally, shall be verified by inspection and test. The inspection shall determine that flat black, lusterless finish or coating has been properly applied. The verification shall be considered successful when the inspection shows the lusterless finish or coat is properly applied and the test shows that the applied lusterless finish or coating has a diffuse reflectance of less than 10% and specular reflectance of less than 1% for angles of incidence of 10, 30, and 60 degrees over a wavelength range of 380-1000 nm. [V.CTS.180]

## **Q.6: Communication System Design**

### **Q.6.1 Audio Volume Control**

The spacecraft shall provide a volume control from 5 to 100% of maximum for each audio channel carrying voice communications. [R.CTS.120]

*Rationale: The crew must have the ability to adjust volume for each audio channel in order to hear and communicate under expected background and radio noise conditions. For example, volume control with 10 steps of 6 dB increments provides acceptable range. Adjustability down to 5% is significant, given the maximum audio level needed for the launch noise environment, as it ensures that crew can adjust volume to a comfortable level in the lower SPL onorbit environment and have adequate speech-to-ambient noise margin. Conversely, the system must ensure that crew do not miss radio calls due to low audio volume or elevated background noise (e.g., alarms present, multiple active communications channels). Visual indicators of audio signal can be an effective means for alerting crew to radio calls.*

**Q.6.1V** The spacecraft's voice-channel volume control shall be verified by test. The test shall be made with flight representative hardware and software. Audio channels carrying voice shall be activated and the volume adjusted, while an operator speaks into the microphone at the sending station. Measurements shall be made, using a Type 1 integrating-averaging sound level meter, at expected head locations at the receiving station. The verification shall be considered successful when the test shows that the measured volume of each audio channel carrying voice communications varies 5 to 100% of maximum across the full range of the volume control. [V.CTS.120]

### **Q.6.2 Loudspeaker Sound Limits**

Loudspeakers shall produce non-speech auditory annunciations with a sound-pressure level that meets the following criteria:

- a. Using measurements of A-weighted sound levels [ISO 7731:2003(E), method a) in 5.2.2.1], the difference between the two A-weighted sound-pressure levels of the signal and the ambient noise is greater than 15 dBA (LS,A-LN,A > 15 dBA).
- b. The alarm signal maximum A-weighted sound level shall not exceed 95dBA at the operating position of the intended receiver.
- c. The alarm signal shall be adjustable to a minimum volume of 15 dBA over the ambient noise environment. [R.CTS.238]

*Rationale: The specified signal-to-noise ratio ensures that non-speech auditory annunciations are sufficiently salient and intelligible, according to ISO 7731, Ergonomics - Danger signals for public work areas auditory danger signals. ISO 7731 is an accepted standard for ensuring the ability to detect and discriminate non-speech alarms and alerts. This requirement allows alarm sound levels to exceed the 85 dBA hazard limit because of the need for alarm audibility. Alarms can be silenced at the crew's discretion. Loudspeakers meeting these criteria can be utilized for alarm to arouse sleeping occupants.*

**Q.6.2V** The CTS's loudspeaker non-speech auditory annunciation levels shall be verified by test. The test shall utilize a flight representative vehicle in the flight configuration with a range of background noise spectra for the mission phases in which the loudspeakers are used. Sound pressure level measurements shall be made with and without the loudspeaker annunciating. The test shall, also, evaluate the adjustment of loudspeaker volume throughout the range of background noise levels. The verification shall be considered successful when the test indicates that the signal is above the ambient noise level established in Q.6.2a by the specified amount and below the level in Q.6.2b, and volume is adjustable within the constraints of Q.6.2c. [V.CTS.238]

### **Q.6.3 Breathing Apparatus Annunciator Intelligibility**

The CTS shall utilize, for contingency breathing apparatus, an auditory speech annunciator or communications system that provides a level of speech intelligibility equivalent to an 80% word identification rate under expected ambient noise levels. [R.CTS.352]

*Rationale: This requirement ensures that auditory speech annunciations and communications are sufficiently salient and intelligible. ANSI S3.2-2009, American National Standard Method for Measuring the Intelligibility of Speech over Communicating System is a widely accepted standard for measuring the intelligibility of speech communications.*

**Q.6.3V** For contingency breathing apparatus, auditory speech annunciations and communications intelligibility shall be verified by analysis and test. The analysis shall derive the nominal background noise spectrum for testing. The test shall be made with a flight representative vehicle in the flight configuration using the methodology given in ANSI S3.2-2009. The verification shall be considered successful when the test and analysis indicates an 80% word identification rate at the ear of the listener throughout the habitable volume. [V.CTS.352]